

















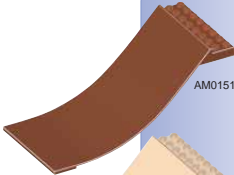





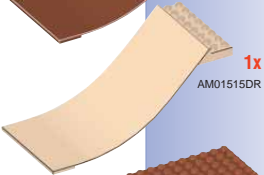





























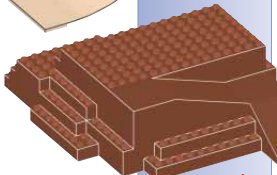









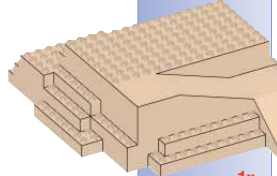











Xtreme

SPORTS BAJA-X™

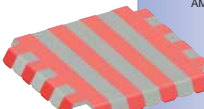

⚠ WARNING:
 CHOKING HAZARD - Small Parts.
 Not for children under 3 years

**MEGA
 BLOKS** 5+

| | | | | | | |
|--|---|--|---|---|---|--|
|  2x M09033A |  15x M09033DR |  1x M09023B |  2x M13122B |  4x M1312F |  |  2x AM01515DH |
|  1x M09033B |  4x M1320DH |  1x M1389B |  1x M1087A |  1x AM1295DO | |  1x AM01515DR |
|  1x AM01488A |  2x M1133F |  1x M1389A |  1x M1087B |  1x AM1294DO | | |
|  1x AM01488B |  10x AM02172JB |  8x M0948DR |  8x M1087DR |  1x AM1276DO | | |
|  4x M1225F |  1x AM02220DH |  1x M0948JN |  2x M1323A |  1x AS091568 | | |
|  2x AM01639JX |  1x AM02223DO |  12x M09493DR |  2x M1323B |  1x AS091566 | | |
|  2x AM01640JX |  1x AM02222DO |  2x M09493F |  2x M1346DR |  1x AS091565 | | |
|  2x AM01643JX |  8x AM02226F |  8x M09593DR |  4x M1346DH |  1x AS091562 | |  1x AM01593DH |
|  2x AM01642JX |  4x M09013DR |  1x M10233DR |  9x M1323DR |  1x AS091563 | | |
|  2x AM02217JX |  2x M09023DR |  2x M10273DR |  2x M1323DH |  1x AS091564 | |  1x AM01593DR |
|  8x AM02219JX |  22x M0910JB |  2x M10273A |  6x M1322DR |  1x AS091567 | | |
|  2x AM02215DH |  2x M1154B |  5x M10273DH |  2x M1418A |  8x M1115N | | |
|  1x AM02221DH |  2x M1154A |  2x M1084JN |  2x M1418B |  2x AM01358W |  1x AM02224DO | |
|  1x M09023A |  11x M09393F |  2x M1322A |  2x AM1296DO |  2x M1172F |  1x AM01530DR | |

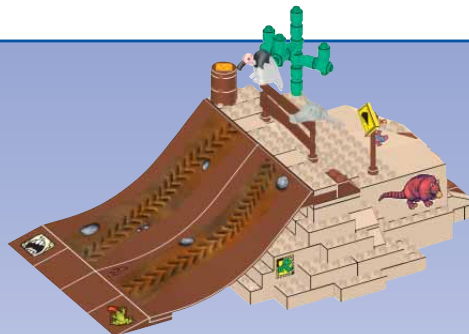
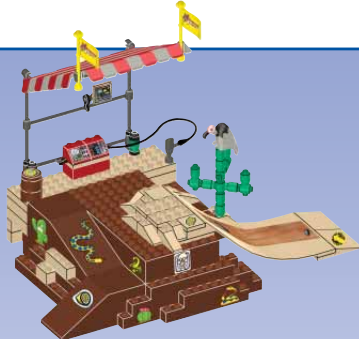

Active step / Étape active / Etapa activa / Azione attiva
Aktivt skede / Actieve stap / アクティブなステップ / 積極步驟
Previous step / Étape précédente / Etapa precedente
Azione precedente / Föregående skedet / Vorige stap
 前のステップ / 上一步驟

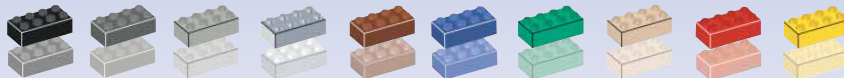

Color chart.

Färgtabell.

Charte de couleurs.

Kleurenkaart.

Cuadro cromático.

カラーチャート

Quadro cromatico.

色彩表



Adult assistance is required. / L'aide d'un adulte est requise. / Necesita ayuda de un adulto. / È necessario l'aiuto di un adulto. /
 Hjälp av en vuxen är nödvändigt. / Hulp van een volwassene is gewenst. / 大人の方が手伝ってあげる必要があります。 / 需要成年人協助



⚠ WARNING:
 Choking hazard— Small parts.
 Not for children under 3 years.

⚠ AVERTISSEMENT:
 Risque de suffocation. Ne convient pas à un enfant
 de moins de 3 ans - contient de petits éléments.

⚠ ADVERTENCIA:
 Peligro de asfixia. No recomendado para niños
 menores de 3 años-contiene piezas pequeñas.

⚠ AVVERTENZA:
 Rischio di soffocamento. Non adatta ad un bambino
 di età minore ai 36 mesi. Contiene parti piccole - non
 ingerire.

⚠ WARNING:
 Risk for kvävning. Ikke egnet til barn under
 3 år - inneholder smådelar.

⚠ WAARSCHUWING:
 Stikgevaar. Niet geschikt voor kinderen onder
 3 jaar - i.v.m. kleine onderdelen.

⚠ 注意:
 飲み込むと危険です。
 小さいパーツがあるので、
 3才以下の幼児には
 与えないでください。
 ⚠ 不適于三岁以下儿童。

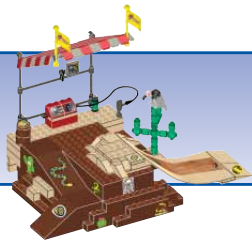

Active step / Étape active / Etapa activa / Azione attiva
 Aktivt skede / Actieve stap / アクティブなステップ / 積極步驟
 Previous step / Étape précédente / Etapa precedente
 Azione precedente / Föregående skedet / Vorige stap
 前のステップ / 上一步驟

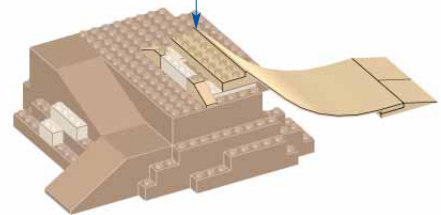
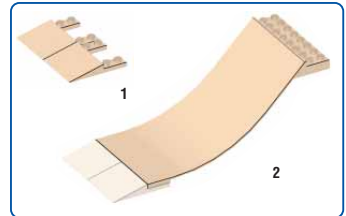
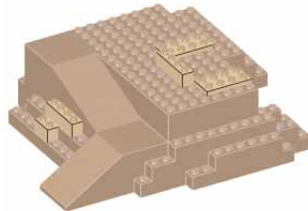
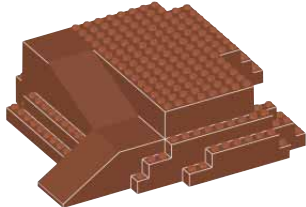
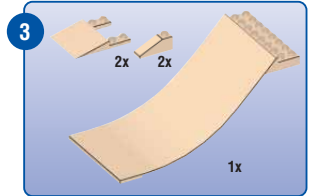
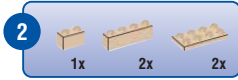
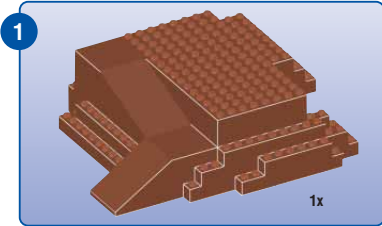

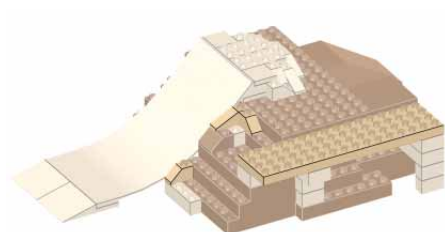
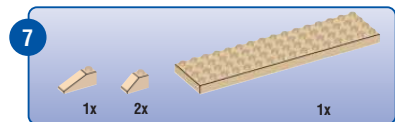
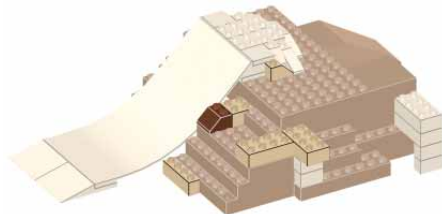
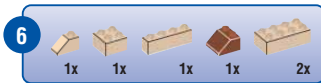
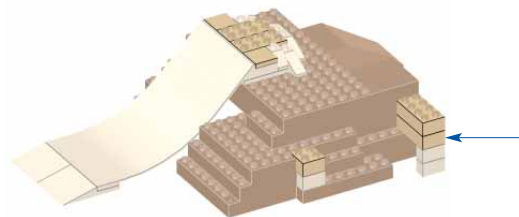
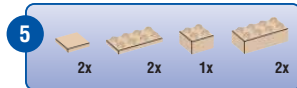
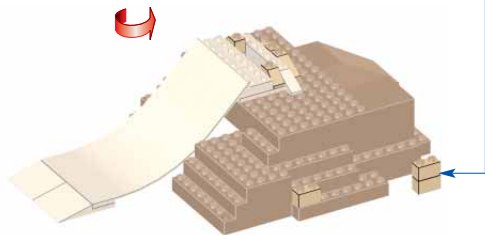
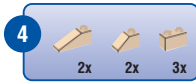

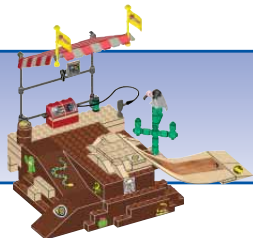

Active step / Étape active / Etapa activa / Azione attiva
 Aktivt skede / Active step / アクティブなステップ / 積極步驟
 Previous step / Étape précédente / Etapa precedente
 Azione precedente / Føregående skedet / Vorige step
 前のステップ / 上一步驟



8

- 1x
- 1x
- 1x
- 1x
- 2x
- 1x
- 1x
- 2x
- 10x
- 5x
- 1x

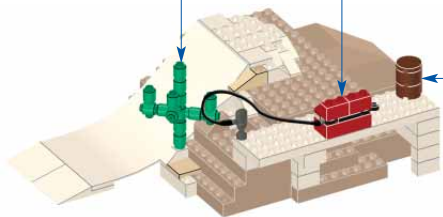
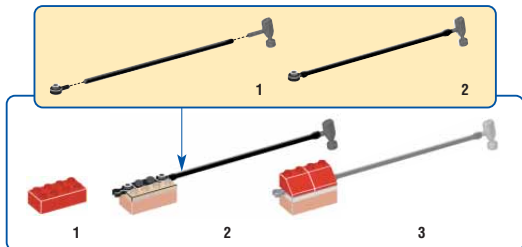
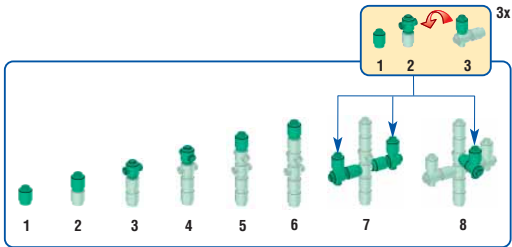

9

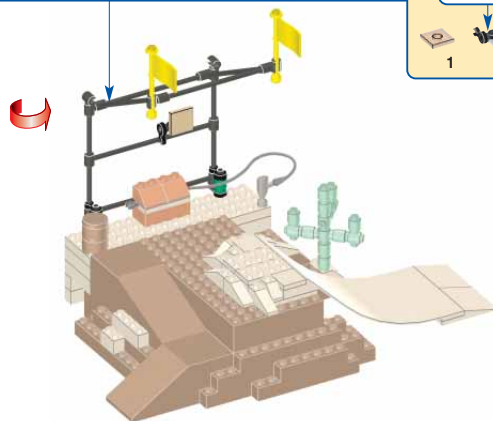
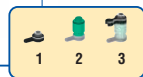
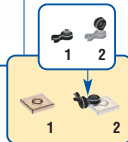
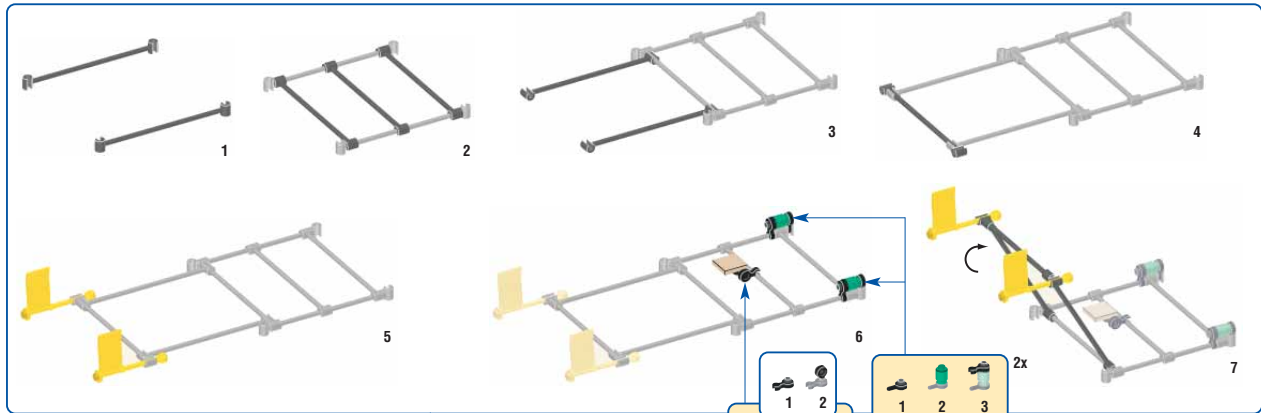
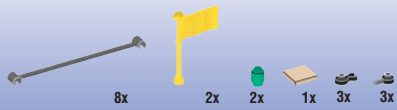

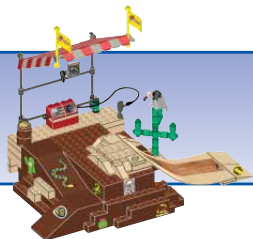

Active step / Étape active / Etapa activa / Azione attiva
 Aktivt skede / Actieve stap / アクティブなステップ / 積極步驟
 Previous step / Étape précédente / Etapa precedente
 Azione precedente / Föregående skedet / Vorige stap
 前のステップ / 上一步驟



10

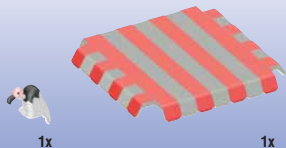

1x

1x

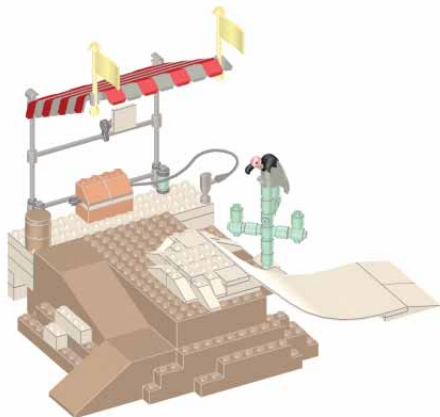

11

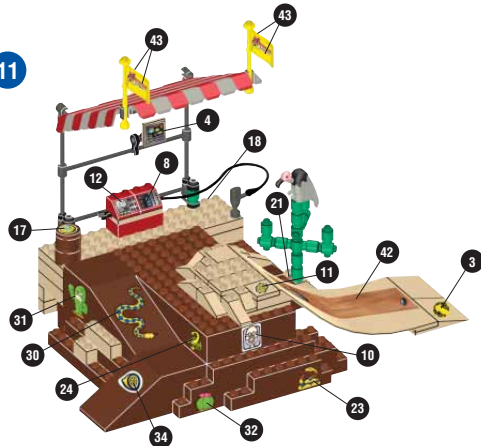

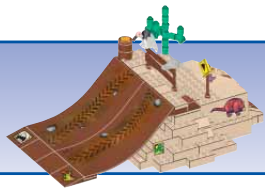

Active step / Étape active / Etapa activa / Azione attiva
 Aktivt skede / Active stap / アクティブなステップ / 積極步驟
 Previous step / Étape précédente / Etapa precedente
 Azione precedente / Föregående skedet / Vorige stap
 前のステップ / 上一步驟

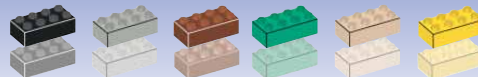

12

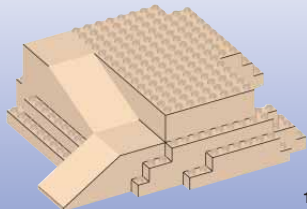

13

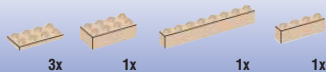

14

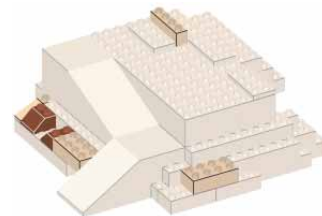
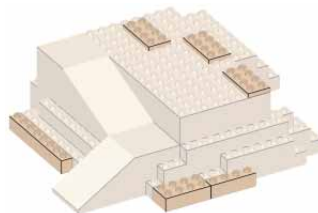
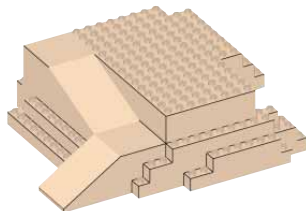
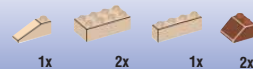

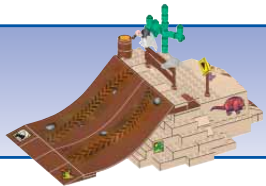

Active step / Étape active / Etapa activa / Azione attiva
 Aktivt skede / Active step / アクティブなステップ / 積極步驟
 Previous step / Étape précédente / Etapa precedente
 Azione precedente / Föregående skedet / Vorige stap
 前のステップ / 上一步驟

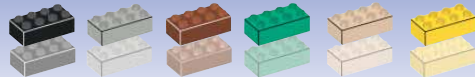

15

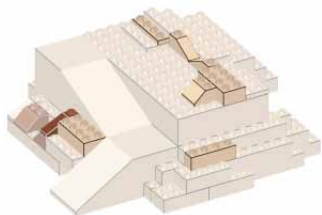
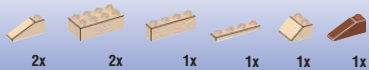

16

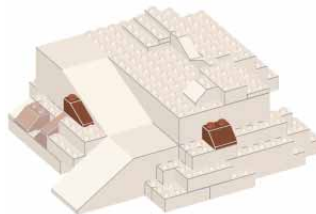

17

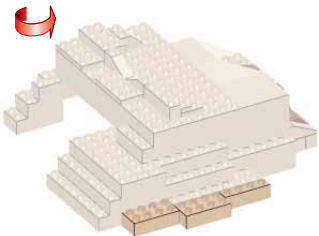
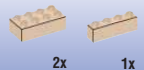

18

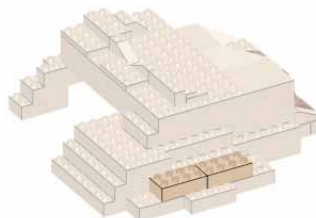

19

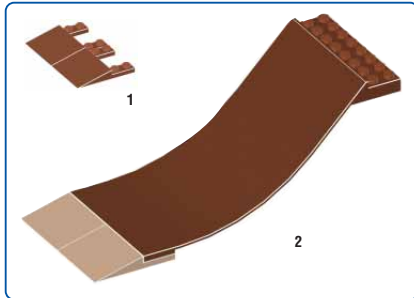
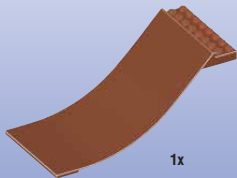

20

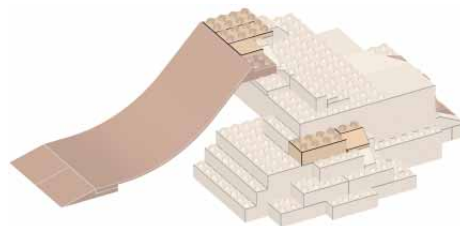
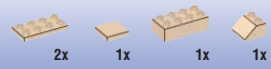

21



22

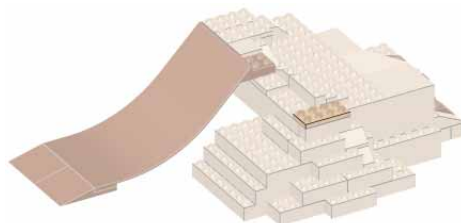

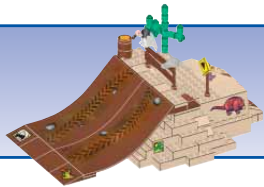

Active step / Étape active / Etapa activa / Azione attiva
 Aktivt skede / Active stap / アクティブなステップ / 積極步骤
 Previous step / Étape précédente / Etapa precedente
 Azione precedente / Föregående skedet / Vorige stap
 前のステップ / 上一步骤

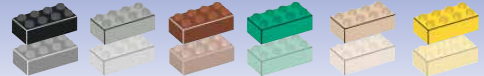

23

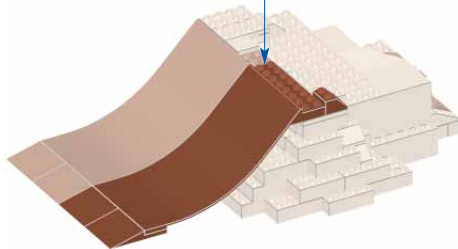
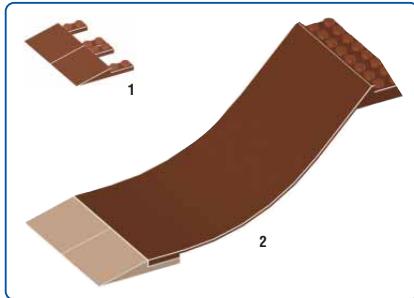
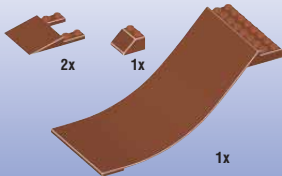

24

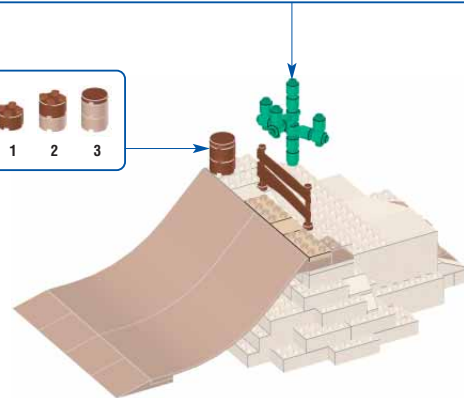
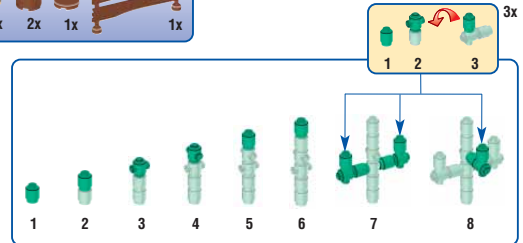

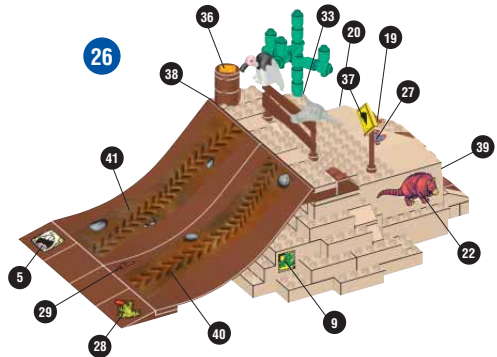
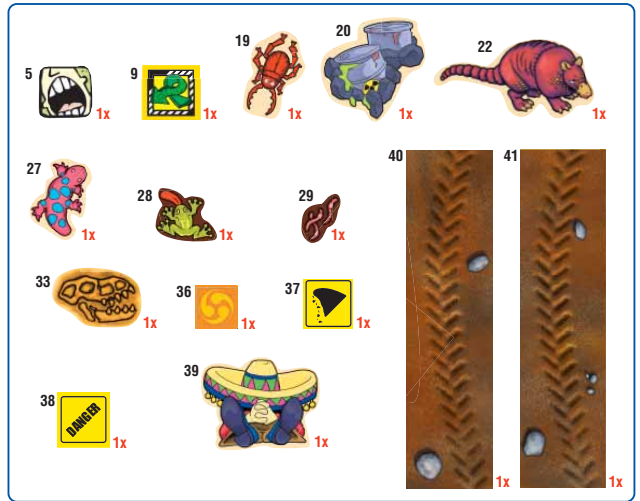
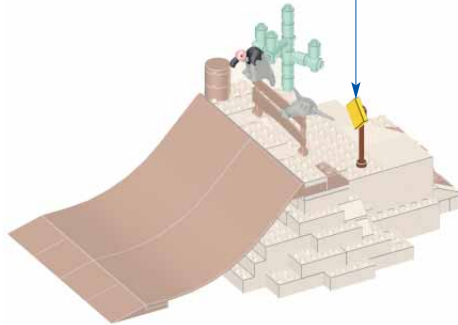
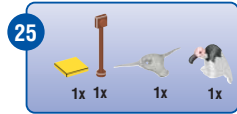



Active step / Étape active / Etapa activa / Azione attiva
 Aktivt skede / Active stap / アクティブなステップ / 積極步驟
 Previous step / Étape précédente / Etapa precedente
 Azione precedente / Föregående skedet / Vorige stap
 前のステップ / 上一步驟

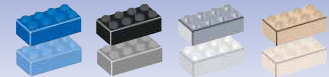

27
 2x [black 1x2 brick] 1x [black 1x4 brick]



28
 1x [black 1x10 brick]



29
 1x [black 1x2 brick]



30
 2x [tan 1x4 brick] 2x [blue 1x2 brick] 2x [blue 1x4 brick] 2x [black 1x2 brick] 4x [grey 1x2 brick]

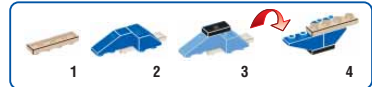

31
 1x [black 1x2 brick] 1x [blue 1x2 brick] 1x [blue 1x4 brick]



32
 2x [blue 1x2 brick] 1x [blue 1x4 brick]



33
 1x [blue 1x2 brick] 2x [blue 1x4 brick] 1x [tan 1x4 brick]

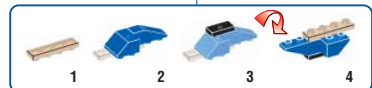

34
 4x [black wheel] 1x [blue 1x2 brick] 1x [tan 1x4 brick] 1x [grey 1x2 brick] 1x [grey 1x4 brick] 1x [grey 1x2 brick] 1x [grey 1x4 brick]

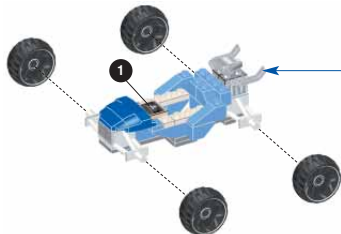

35
 1 [grey 1x2 brick] 2 [grey 1x4 brick] 3 [grey 1x2 brick]

35
 1x [grey 1x2 brick]

1
 1x [black wheel]



36
 14 [grey 1x2 brick] 15 [grey 1x4 brick] 7 [grey 1x2 brick] 25 [grey 1x2 brick] 1x [grey 1x2 brick] 1x [grey 1x4 brick] 1x [grey 1x2 brick] 2x [grey 1x2 brick]

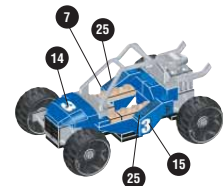



Active step / Étape active / Etapa activa / Azione attiva
 Aktivt skede / Active step / アクティブなステップ / 積極歩様
 Previous step / Étape précédente / Etapa precedente
 Azione precedente / Föregående skedet / Vorige stap
 前のステップ / 上一歩様

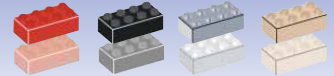

37
 2x 1x



38
 1x



39
 1x



40
 2x 2x 2x 2x 4x



41
 1x 1x 1x

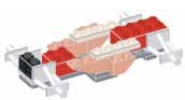

42
 2x 1x



43
 1x 2x 1x

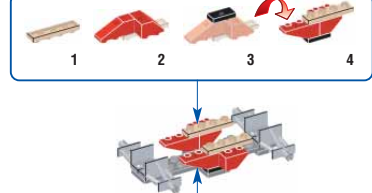
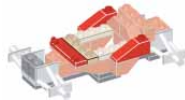

44
 4x 1x 1x 1x 2x 1x 1x

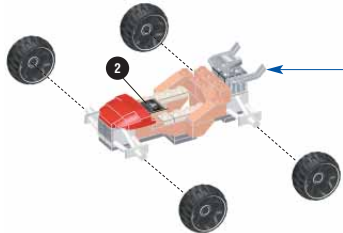

1 2 3

2 1x

45
 1x



46
 1x 1x 1x 1x 2x

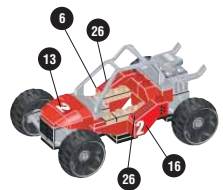

Xtreme

SPORTS BAJA-X™

COLLECT THEM ALL!
COLLECTIONNE-LES TOUS!
¡COLECCIONALOS TODOS!



9171 SKATE™



9173 SNOW™



9172 BMX™



9174 MOTO X™



9161 SKATEZONE™



9163 MOTO X™



9169 SKATECITY™



9159 MOTO X PARK™

REAL MOTO-X SOUNDS!
SONS RÉELS DE MOTO-X!
¡SONIDOS AUTÉNTICOS DE MOTO-X!

