

HALO WARS™

THE AUTHENTIC COLLECTOR'S SERIES



96833 | UNSC Wolverine

**MEGA
BLOKS**

- 1X** MA113AJM
- 2X** AM03328AJM
- 2X** MA1312AJM
- 2X** AM15258AJM
- 10X** AM04428AJM
- 6X** MA02250AJM
- 12X** AM04430AJM
- 1X** AM03019AJM
- 2X** AM09835AJM
- 1X** AM03773AJM
- 6X** MA0948AJM
- 2X** A59683306
- 2X** MA1154AJM

- 6X** MA1314AJM
- 4X** MA10273AJM
- 2X** AM16641AJM
- 6X** MA1323AJM
- 4X** AM04497AJM
- 2X** AM03091AJM
- 10X** MA09593AJM
- 1X** MA1390AJM
- 4X** MA9493AJM
- 5X** MA09033AJM

- 1X** AM16629AJM
- 1X** AM16630AJM
- 2X** AM16962AJM
- 2X** AM16976AJM
- 1X** A59683303
- 1X** AM04983AJM
- 5X** MA1480AJM
- 4X** AM08483AJM

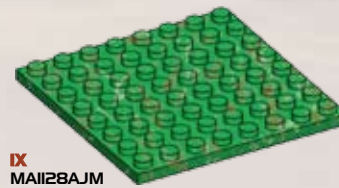

1X MA128AJM



1X A59683301



2X SA1116MM



1X AM09923MM



1X L968331

- 2X** AM16980MM
- 2X** MA10273MM
- 2X** MA1314MM
- 2X** AM16977MM
- 4X** AM0317MM
- 2X** AM16963MM
- 4X** MA1087MM
- 2X** MA09033MM

2X
AM0328F

8X
AM09198F

4X
MA09393F

3X
AM09835F

2X
AM16954F

4X
AM15484F

2X
AM16975F

2X
MA09013F

2X
MA1133F

2X
MA1133F

2X
MA1417F

4X
MA1154F

6X
MA9023F

2X
AM04430F

6X
AM03772F

2X
MA1142F

3X
MA1141F

4X
AM07230F

IX
AM09931F

8X
AM02783F

7X
MA09593F

IX
AM09838F

6X
MA09493F

IX
AM09921F

2X
AM16959F

2X
AS9683305

2X
AS9683317

2X
MA1087F

3X
MA9033F

IX
AM03089F

IX
MA1346F

2X
AM09292F

IX
MA1313F

10X
MA1480F

IX
AM03015F

IX
AM07646F

IX
AM09923F

IX
AM09924F

3X
AM04985F

4X
MA1172F

IX
SA1163F

2X
AM16646F

2X
AM169495X

2X
AM169365X

IX
AM16950MM

IX
AM16950MM

IX
AS9683307

IX
AS9683313

IX
AS9683308

IX
AS9683310

IX
AM16951MM

IX
AM16951MM

IX
AS9683309

IX
AM16700MM

IX
AS9683312

IX
AS9683311

IX
AM16701MM

IX
AS9682101

2X
M1113W

IX
M1113ZD

2X
AM01855BRD

2X
M022502X

2X
M022502ZD

IX
AM02151BRD

8X
AS9683302

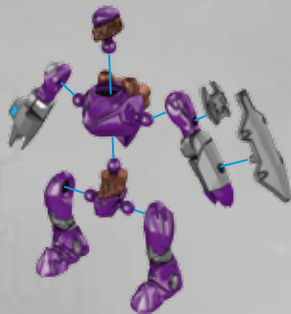

1

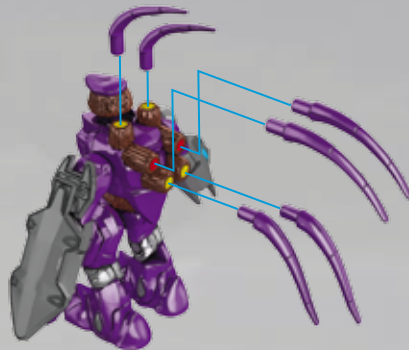

2



3



EN Please read these instructions carefully before first use and keep them for future reference. / **ES** Leer estas instrucciones cuidadosamente antes de la primera utilización y guardarlas para referencia futura. / **FR** Il est recommandé de lire attentivement ce feuillet avant la première utilisation et de le conserver pour référence future. / **DE** Die Gebrauchsanleitung bitte durchlesen und aufbewahren. / **NL** Wij raden u aan deze handleiding zorgvuldig te lezen en te bewaren voor eventuele raadpleging op een later tijdstip. / **IT** Leggere le istruzioni prima di cominciare ad usare il gioco e conservarle per referenze future. / **PT** Leia as instruções antes do primeiro uso e guarde-as para futura referência.

EN ⚠ **WARNING:**
CHOKING HAZARD. - Small parts.
Not for children under 3 years.

ES ⚠ **ADVERTENCIA:**
PELIGRO DE ASFIXIA. - Contiene piezas pequeñas.
No recomendado para niños menores de 3 años.

FR ⚠ **AVERTISSEMENT:**
RISQUE DE SUFFOCATION. - Présence de petits éléments.
Ne convient pas aux enfants de moins de 3 ans.

DE ⚠ **WARNUNG:**
ERSTICKUNGSGEFAHR. - Enthält kleine Teile.
Nicht für Kinder unter 3 Jahren geeignet.

NL ⚠ **WAARSCHUWING:**
VERSTIKKINGSGEVAAR. - Bevat kleine onderdelen.
Niet geschikt voor kinderen onder de 3 jaar.

DA ⚠ **ADVARSEL:**
KVÆLNINGSFARE. - Indeholder smådele.
Ikke til børn under 3 år.

EL ⚠ **ΠΡΟΕΙΔΟΠΟΙΗΣΗ:**
ΚΙΝΔΥΝΟΣ ΠΝΙΞΙΜΑΤΟΣ. - Περιέχει μικρά αντικείμενα
Οχι για παιδιά κάτω των 3 ετών.

FI ⚠ **VAROITUS:**
TUKEHTUMISVAARA. - Sisältää pieniä osia.
Ei alle 3-vuotiaille lapsille.

IT ⚠ **ATTENZIONE:**
PERICOLO DI SOFFOCAMENTO. - Contiene piccole parti.
Non indicato per bambini sotto i 3 anni.

NO ⚠ **ADVARSEL:**
KVELNINGSFARE. - Inneholder små deler.
Kun for barn over 3 år.

PT ⚠ **ATENÇÃO:**
PERIGO DE ASFIXIA. - Contém peças pequenas.
Não é concebido para crianças de menos de 3 anos.

SV ⚠ **VARNING:**
KVÄVNINGSRISK. - Innehåller små delar.
Inte för barn under 3 år.

JA ⚠ **警告:**
窒息の危険性 - 小さな部品が含まれています
3歳以下の子供には与えないで下さい。

ZH ⚠ **警告:**
有窒息危险。- 包含有小部件
不适合3岁以下的小孩玩。

AR ⚠ **تحذير:**
خطر اختناق - قطع صغيرة.
غير صالحة للأطفال أقل من 3 سنوات.



© 2009 MICROSOFT CORPORATION. ALL RIGHTS RESERVED. MICROSOFT, HALO, THE HALO LOGO, HALO WARS, XBOX, THE XBOX LOGO, ARE TRADEMARKS OF THE MICROSOFT GROUP OF COMPANIES.

halowars.megabloks.com



UNSC

COVENANTS

CAMOUFLAGE EFFECT • EFECTO DE CAMUFLAJE • EFFET CAMOUFLAGE TARNEFFEKT • CAMOUFLAGE-EFFECT • EFFETTO MIMETICO • EFFETTO CAMUFLAGEM

HALO WARS™
THE AUTHENTIC COLLECTOR'S SERIES



© 2009 Microsoft Corporation. Microsoft, Halo, the Halo logo, Halo Wars, Xbox, the Xbox logo, are trademarks of the Microsoft group of companies.



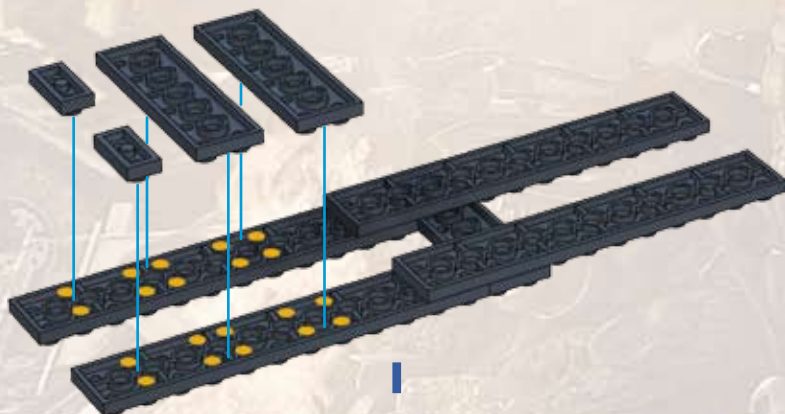
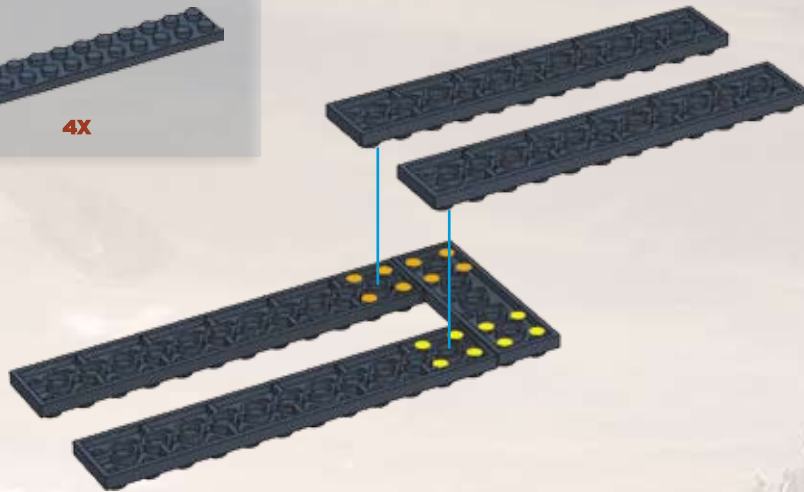

3

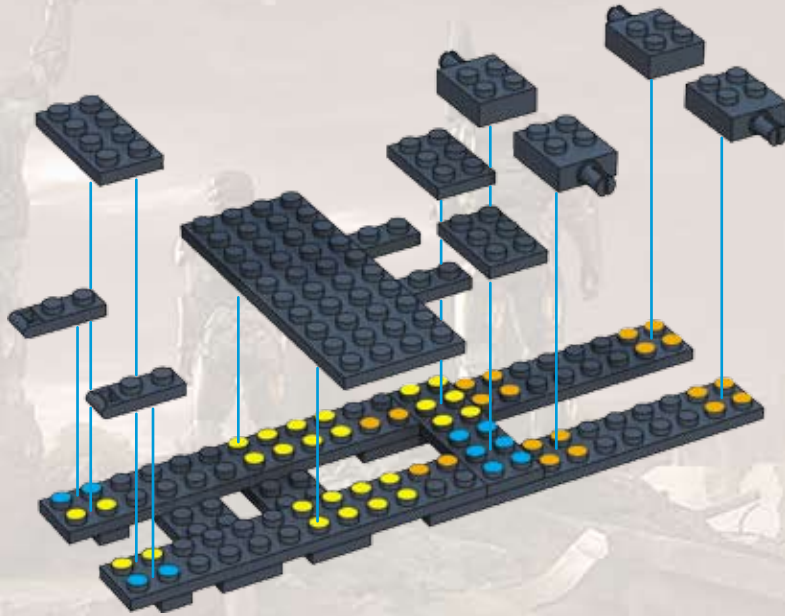
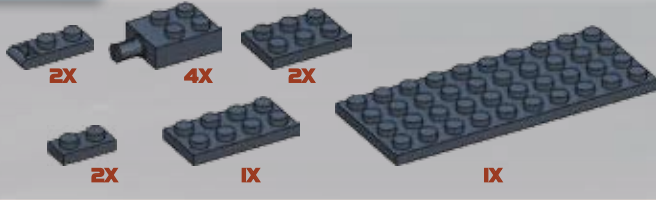

4

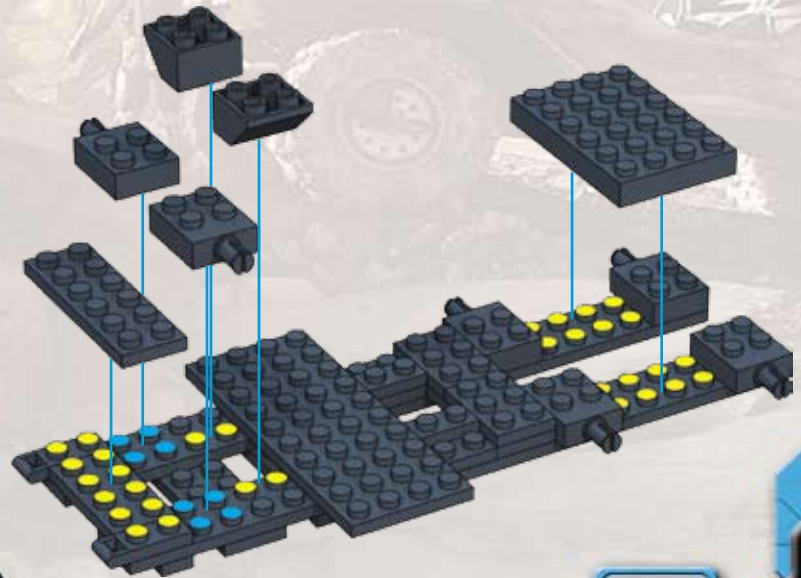

7

5

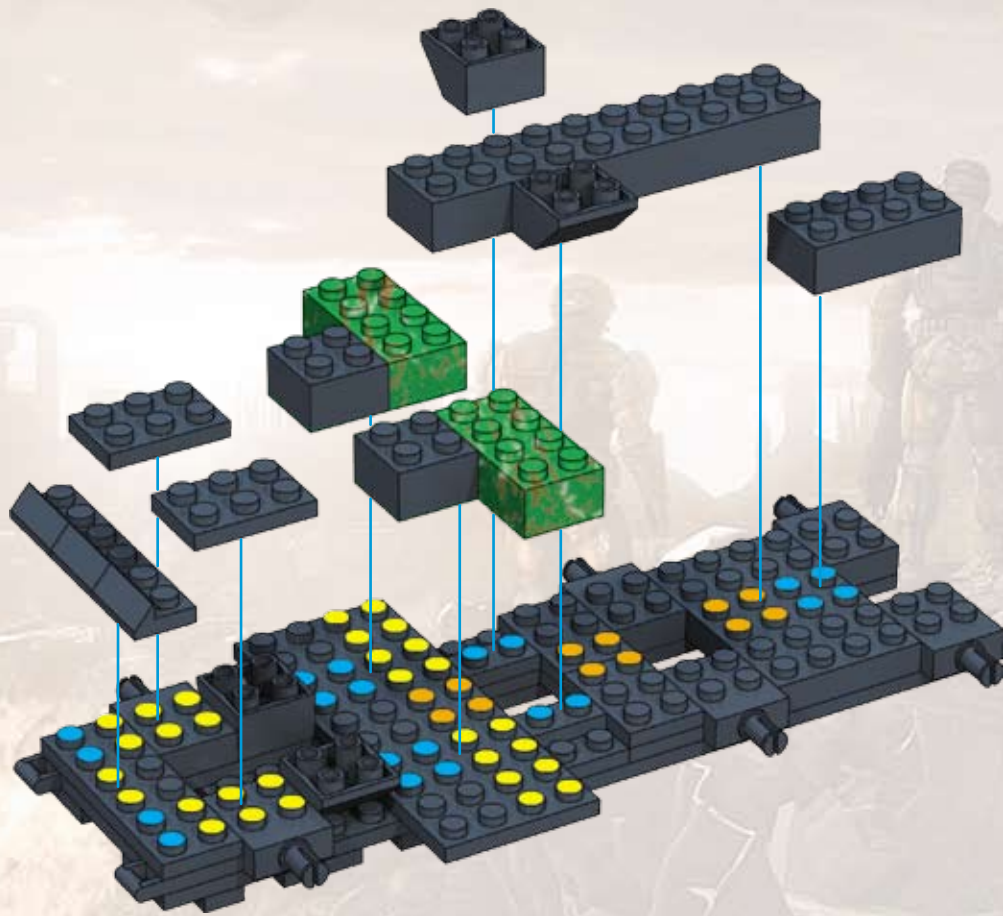
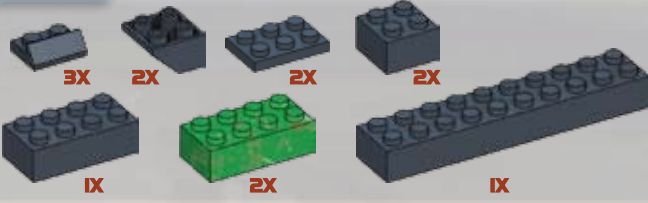

6

2x



2x



1x

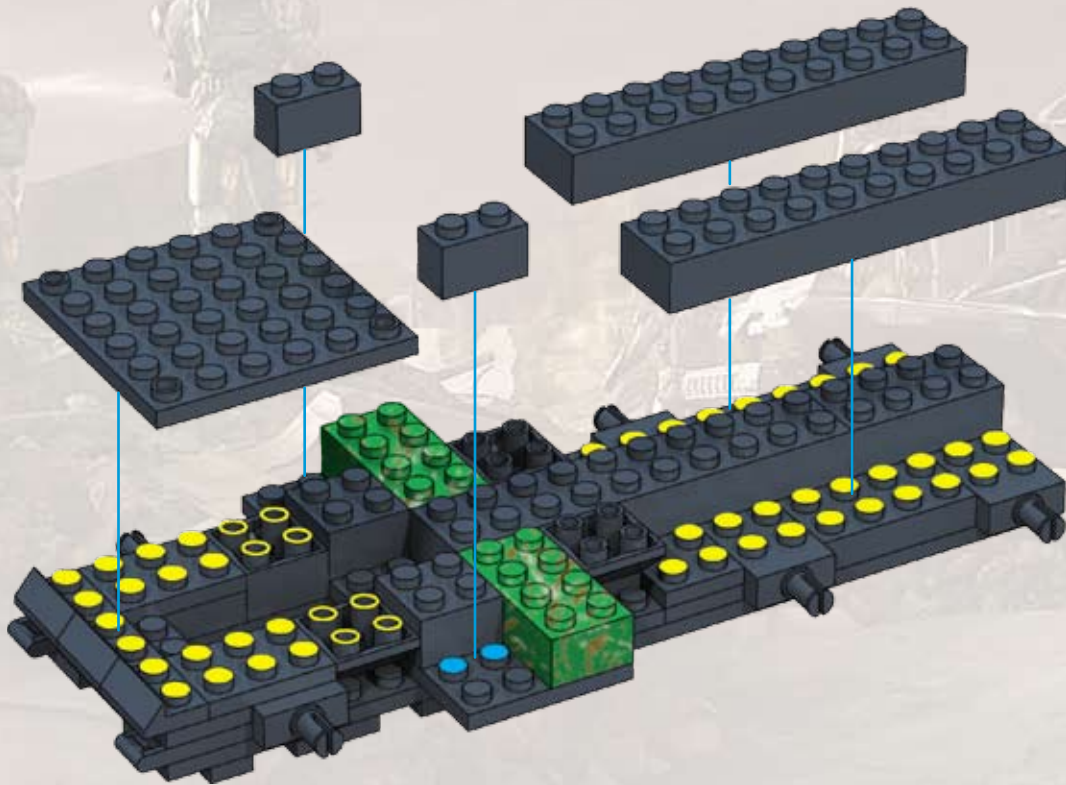

9

MEGA
BLOKS

7

2X

2X

3X

1X

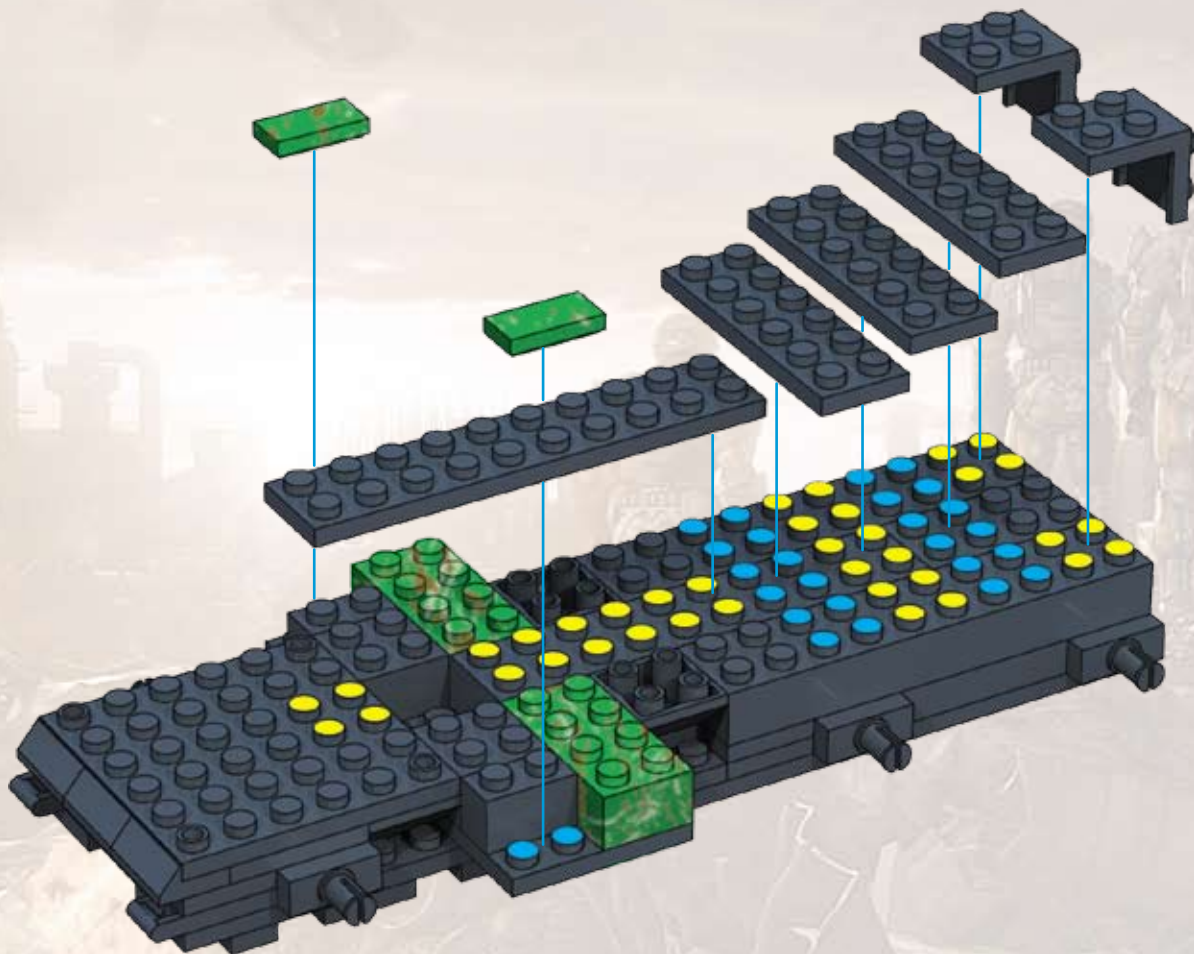

8

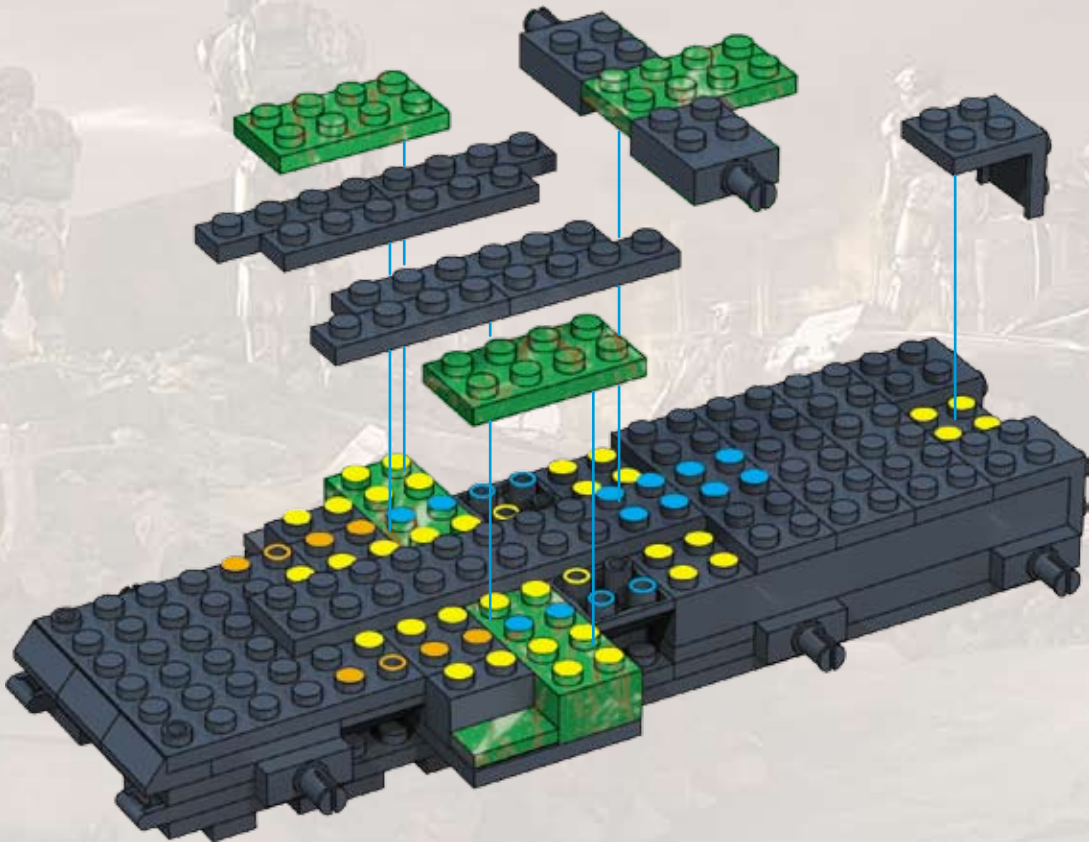

9

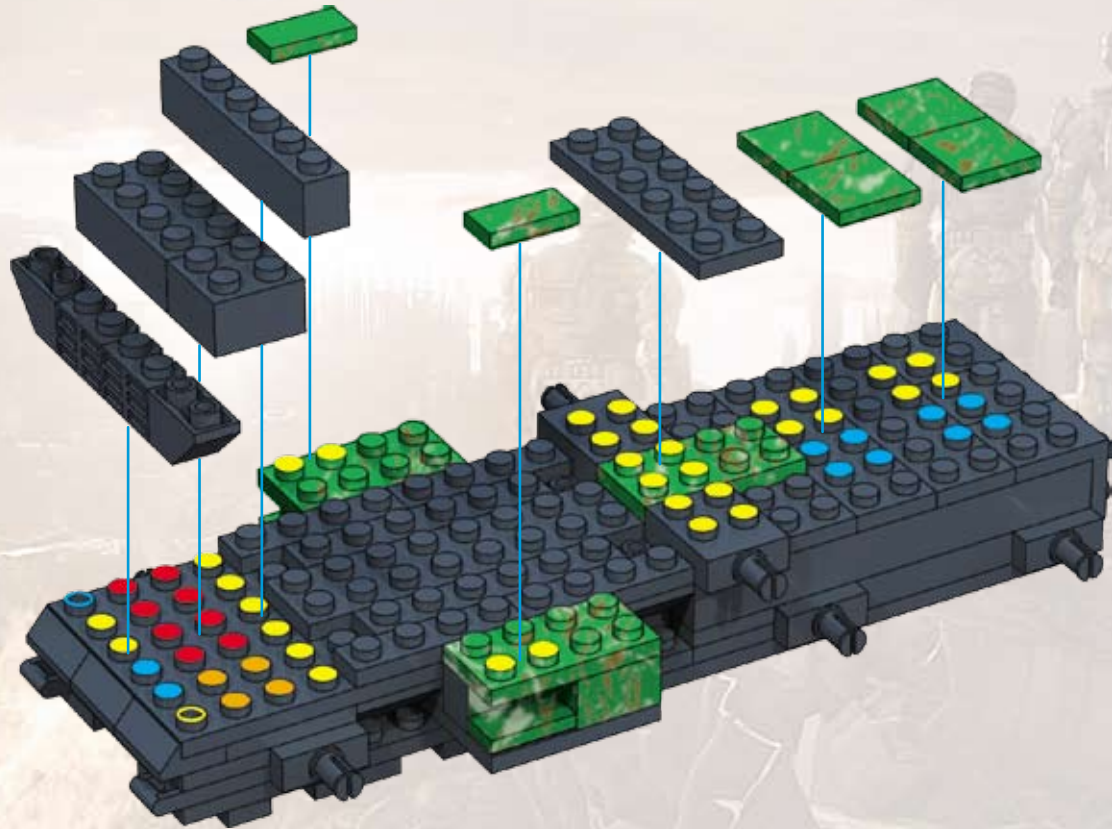
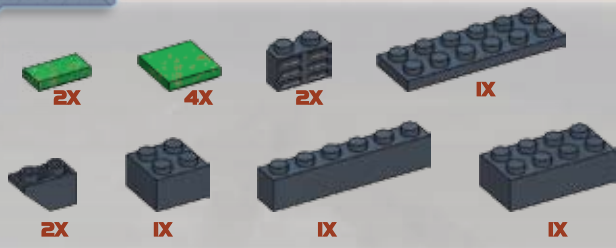

10

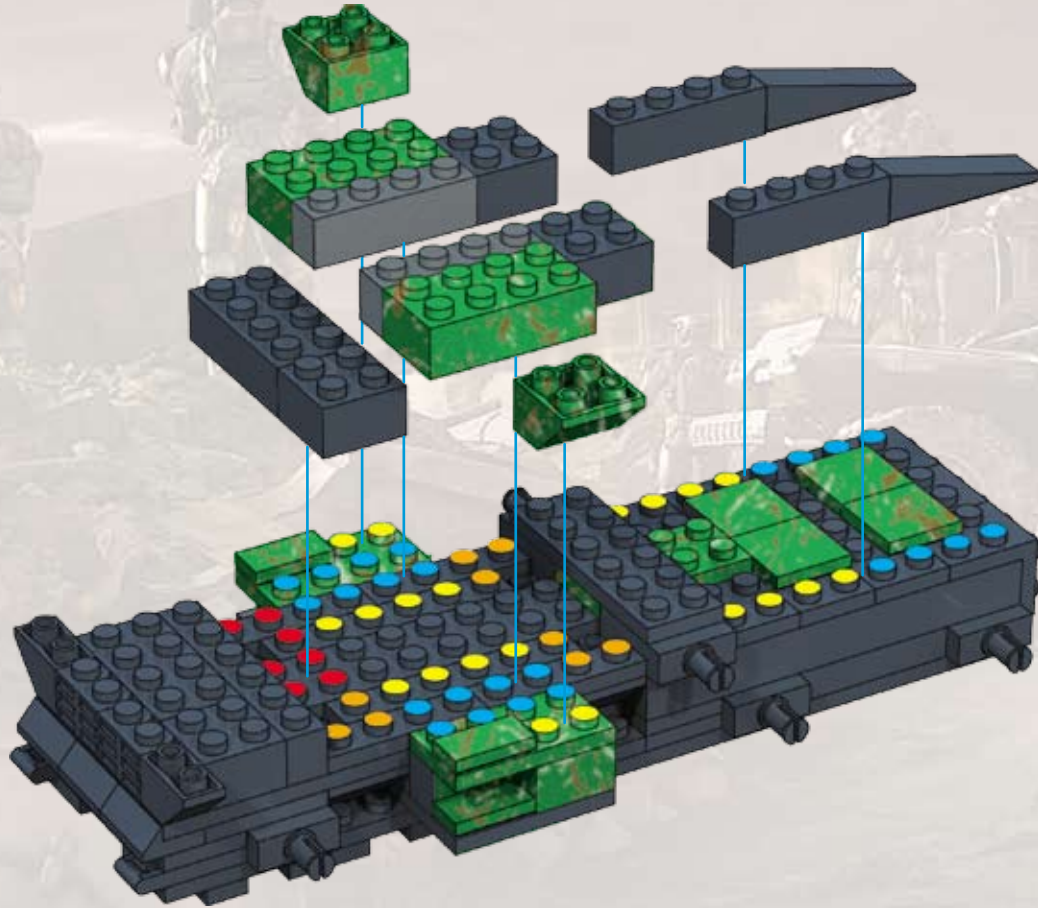
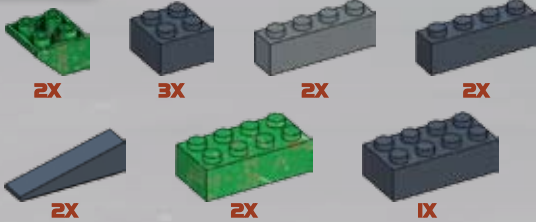

13



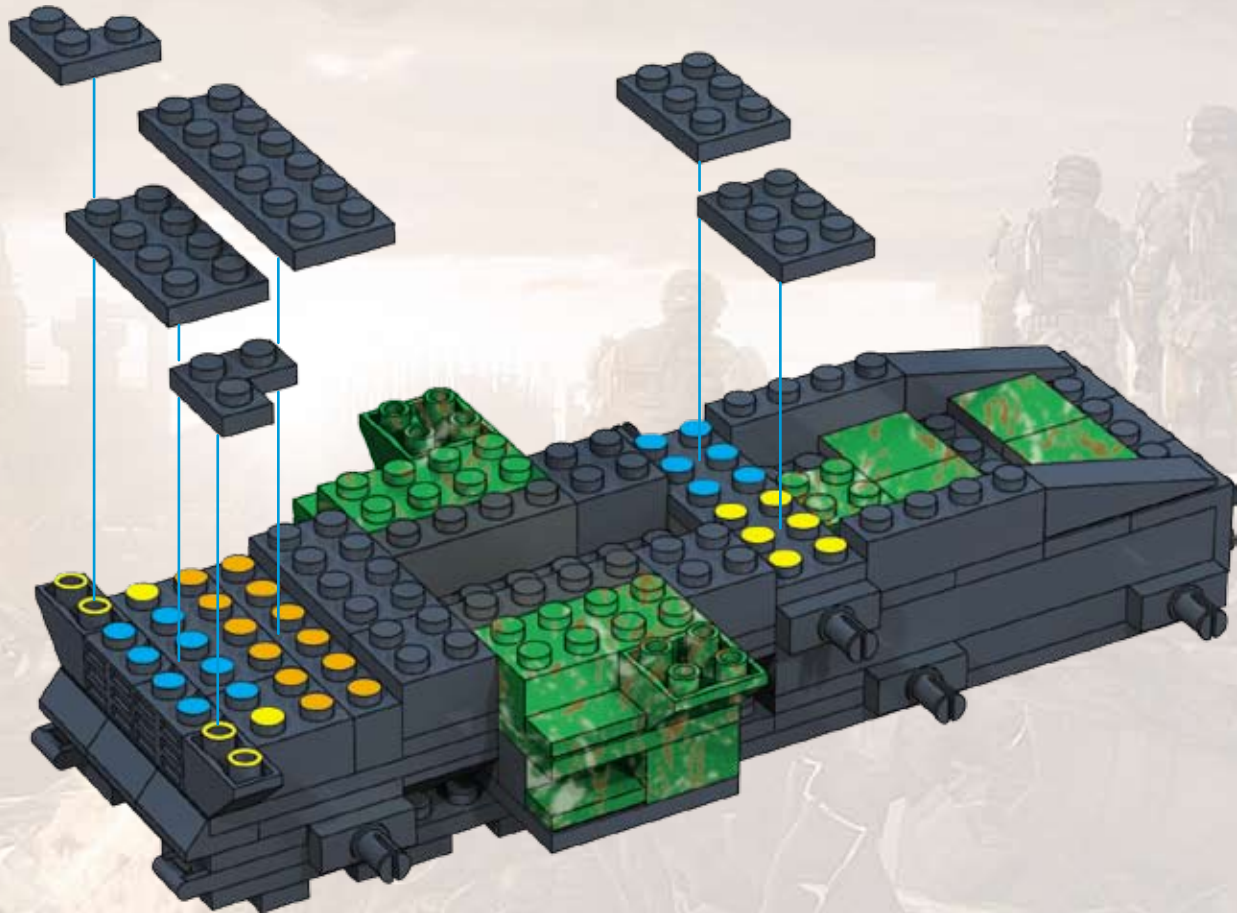

12

- 2X (green 1x2 brick with hole)
- 4X (green 1x2 brick with hole)
- 2X (dark grey 1x4 plate)
- 4X (green 1x6 brick with hole)
- 1X (dark grey 1x3 curved brick)
- 2X (green 1x10 brick with hole)

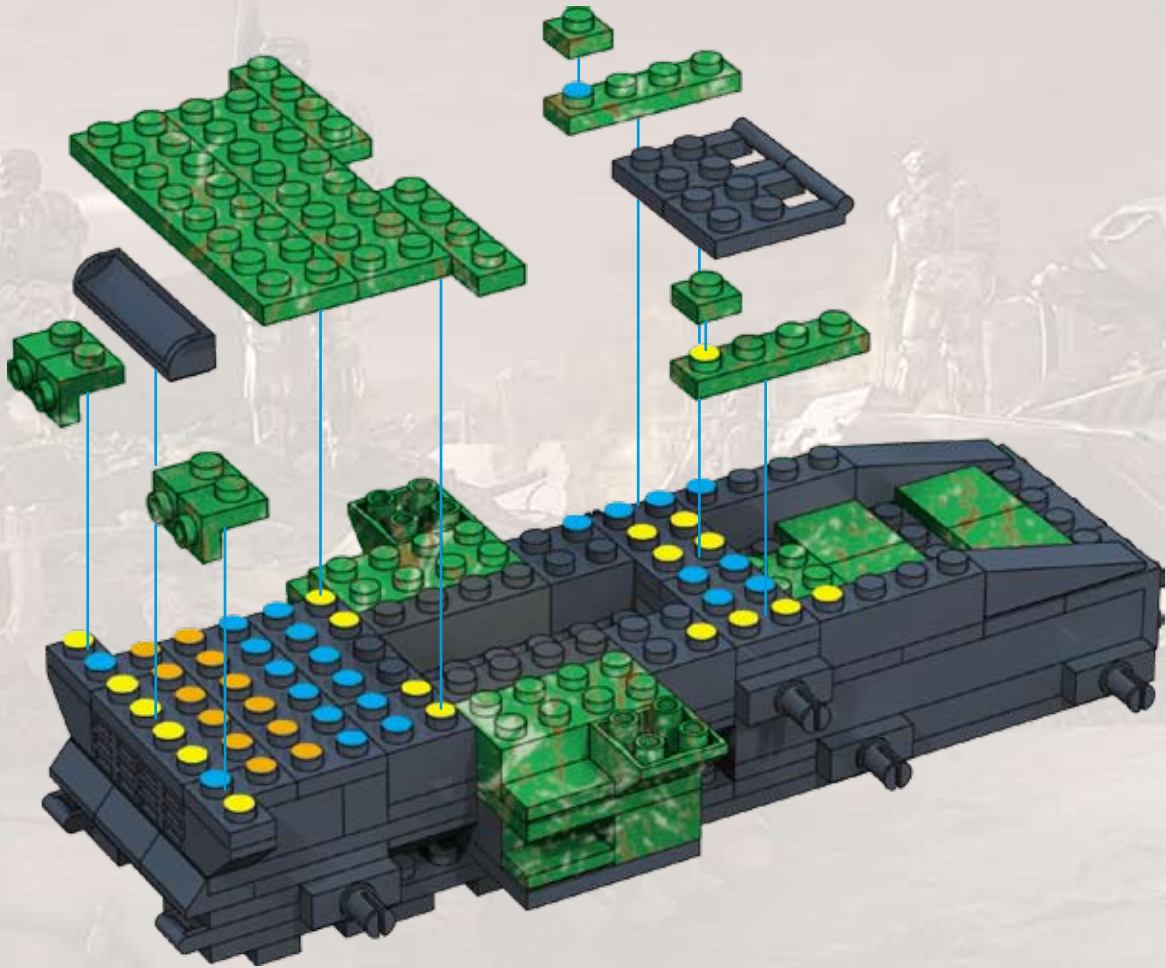

15

MEGA BLOKS

13

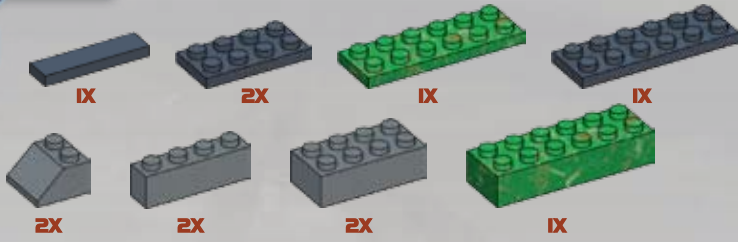

10



10

10

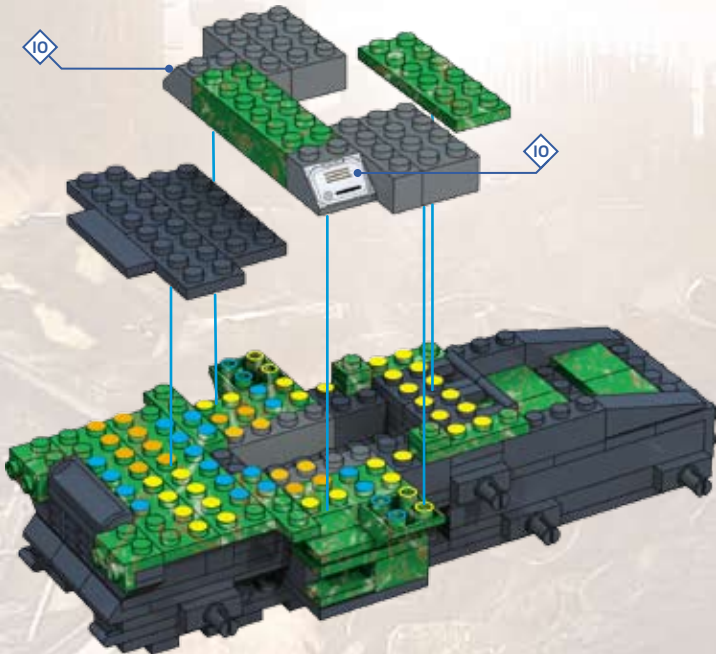

14

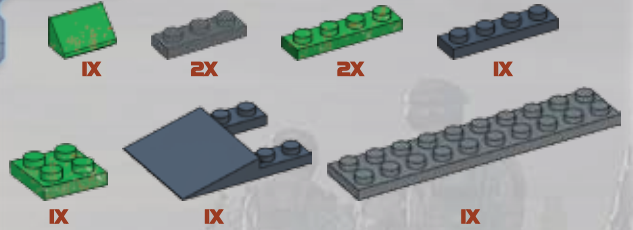

10

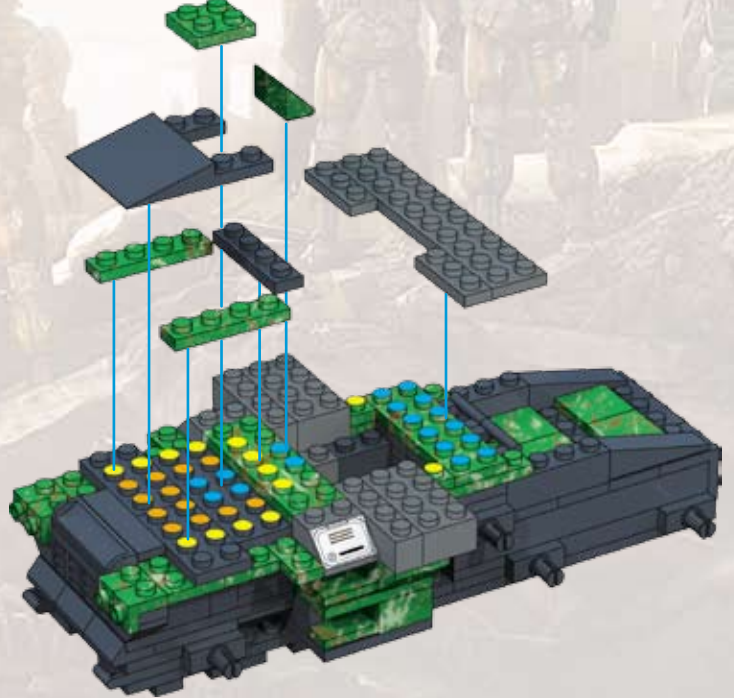

16

15



2X



4X

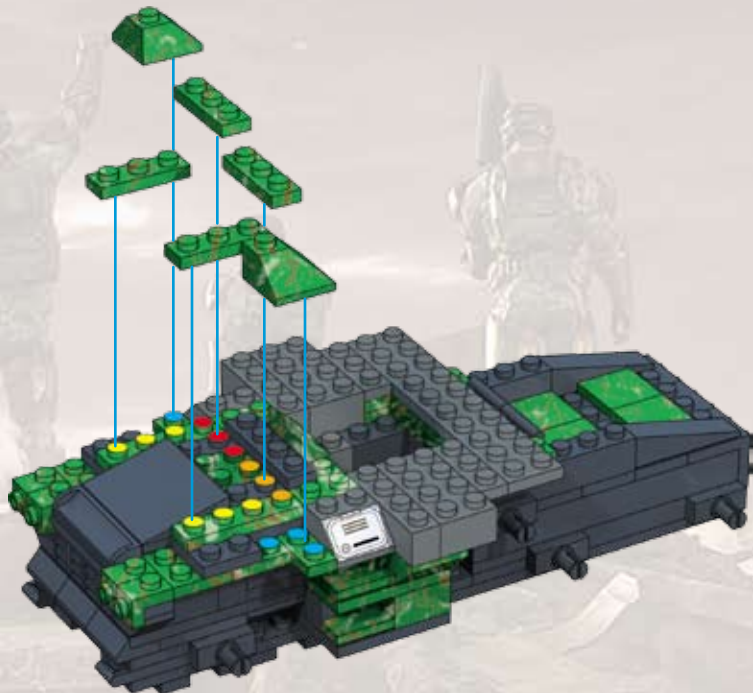

16



6X



4X

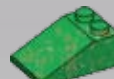

2X

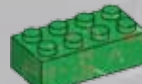

1X

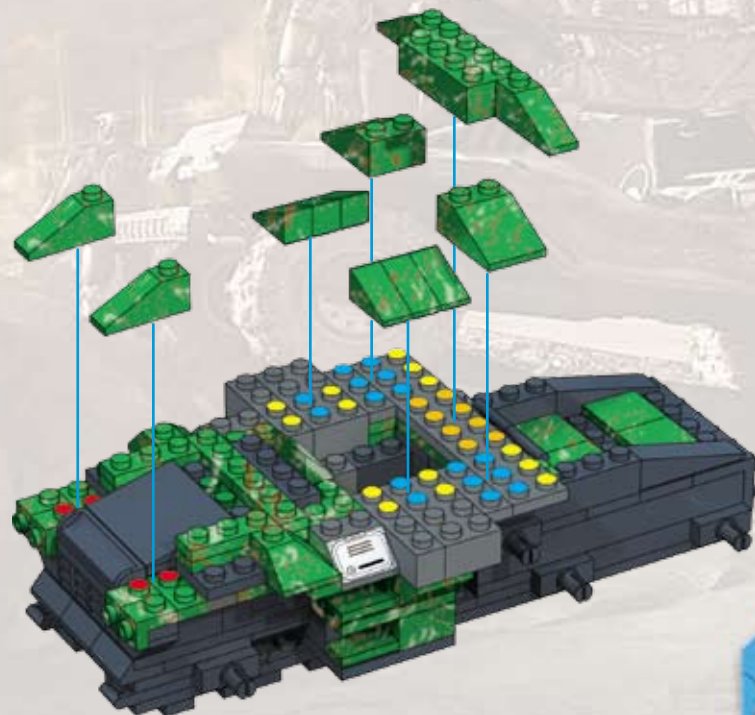

17

MEGA
BLOKS

17

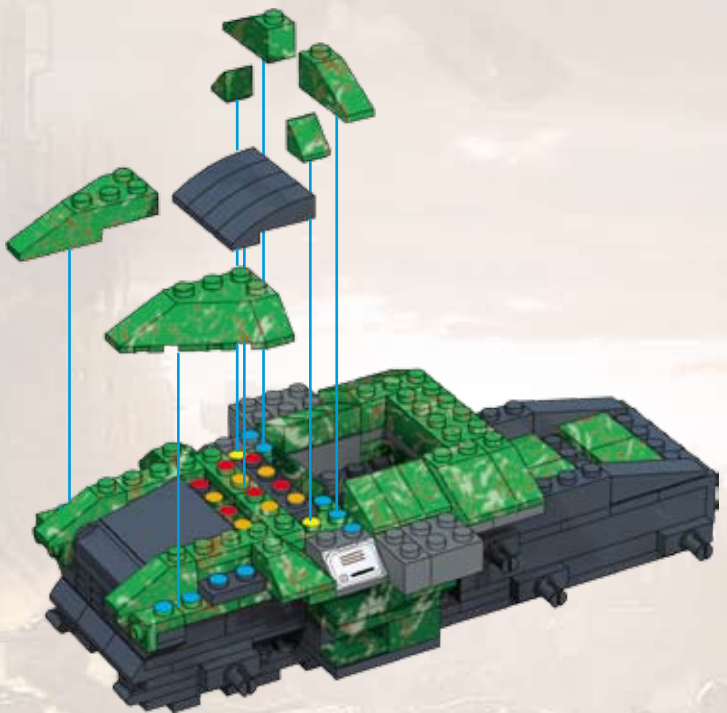

18

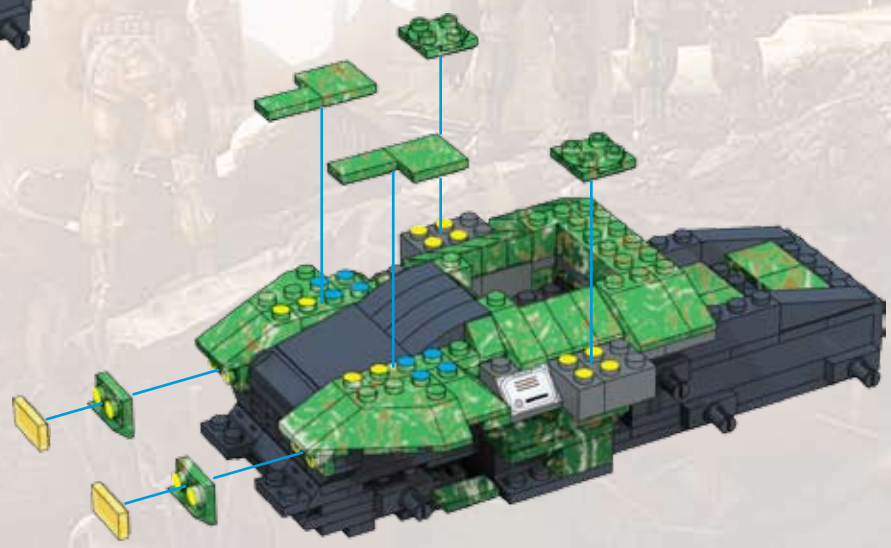

18

19

2X 2X 1X

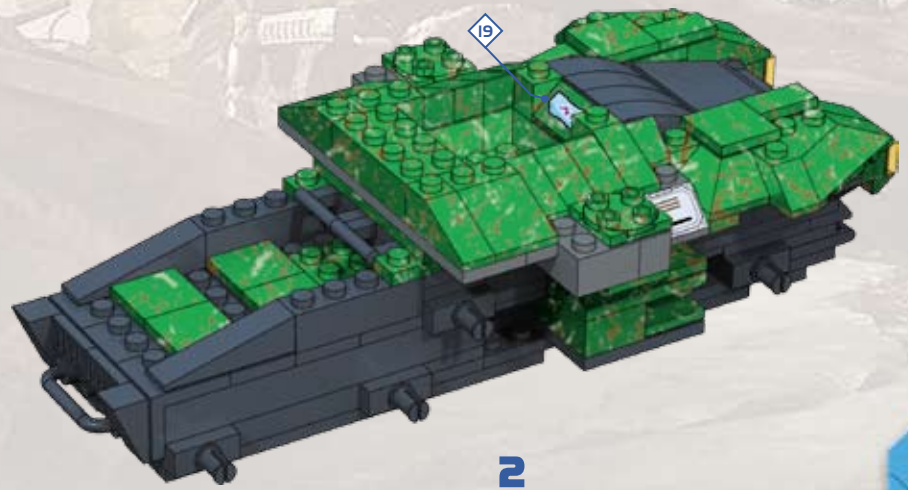
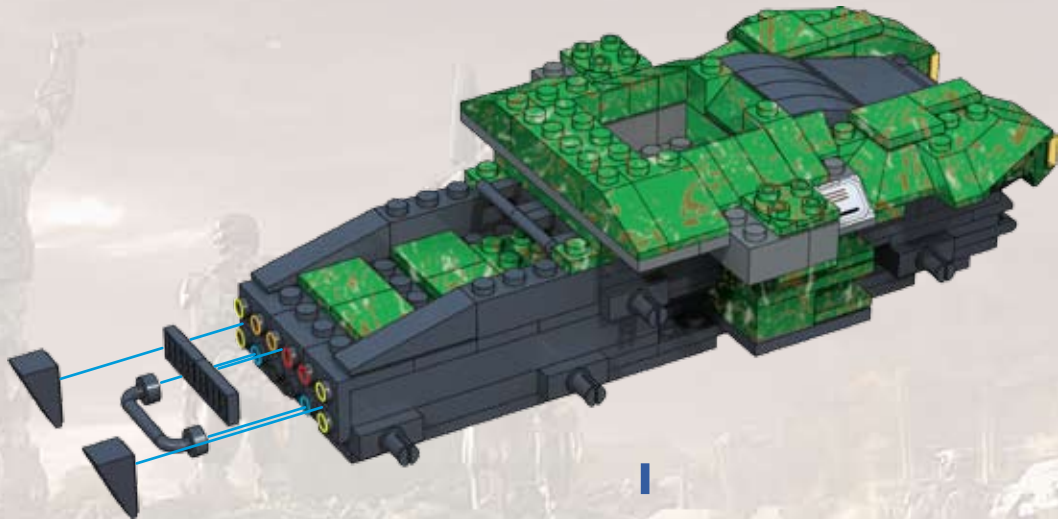

20

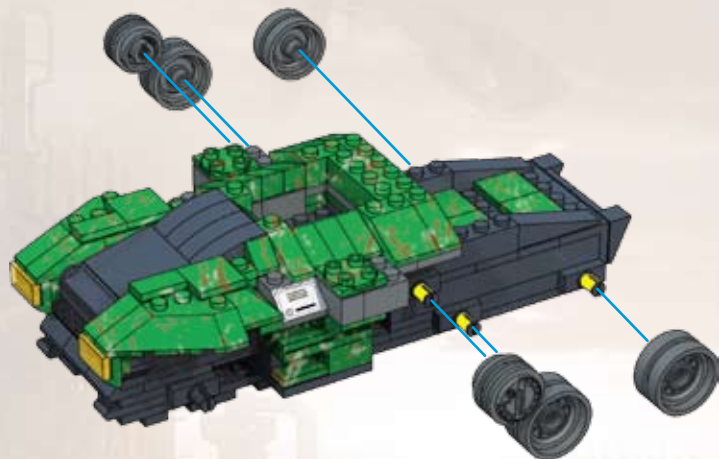

21

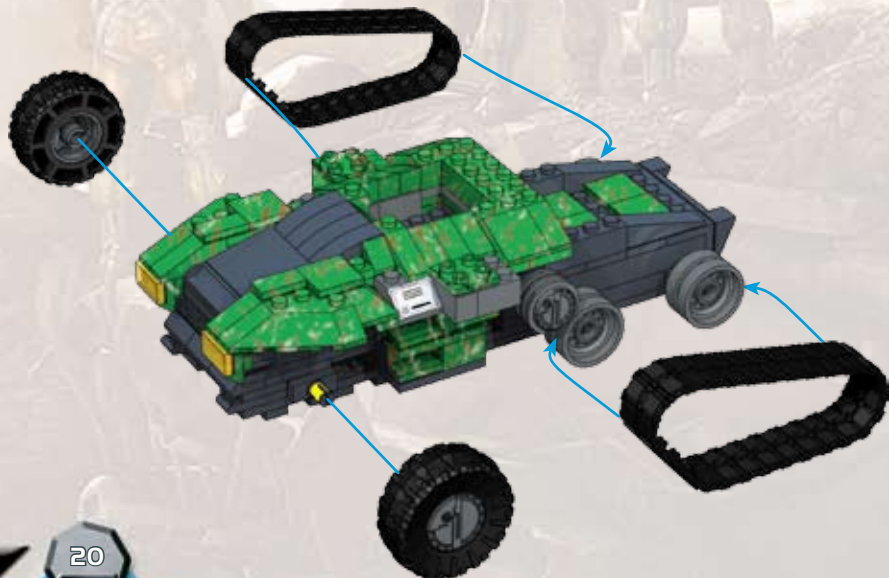

20

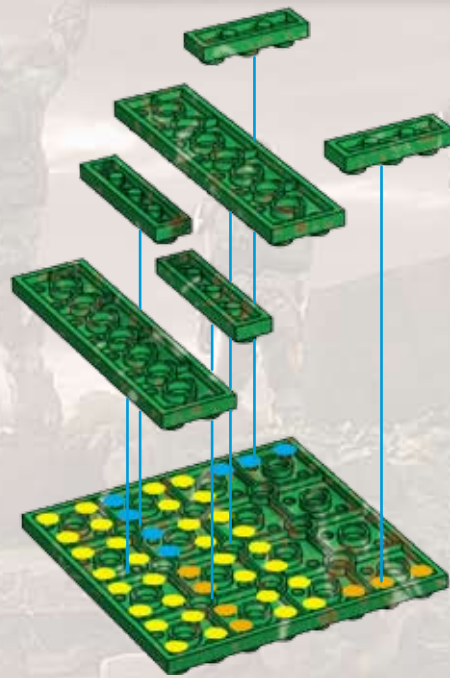
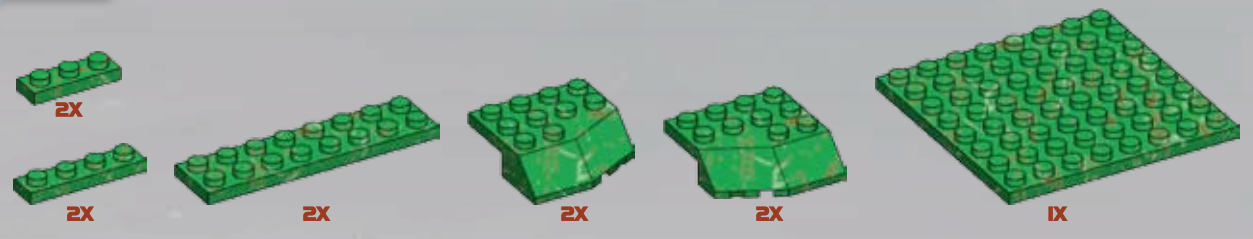

1



2

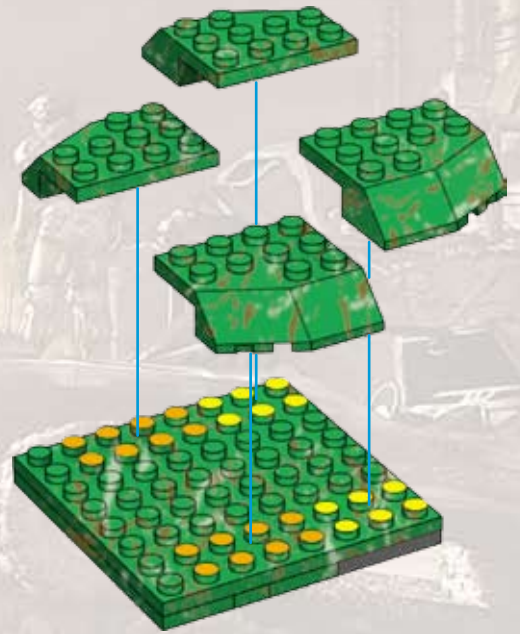

3

18



18

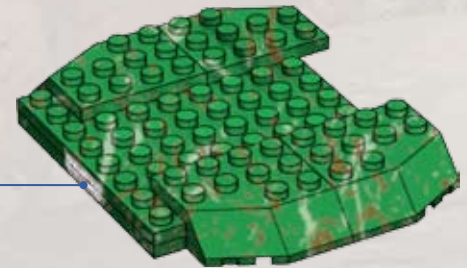

4

21



2X



2X



6X



6X



6X

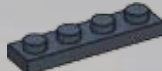

2X

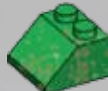

4X

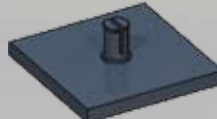

1X

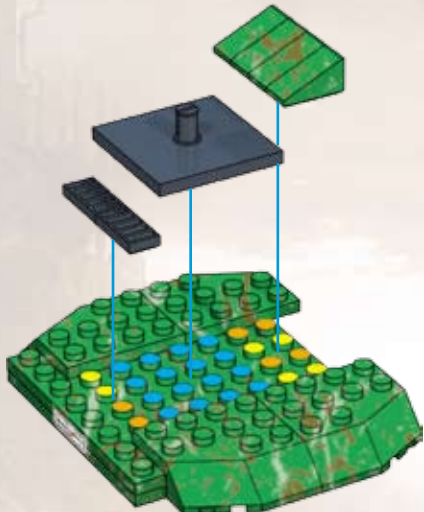

1

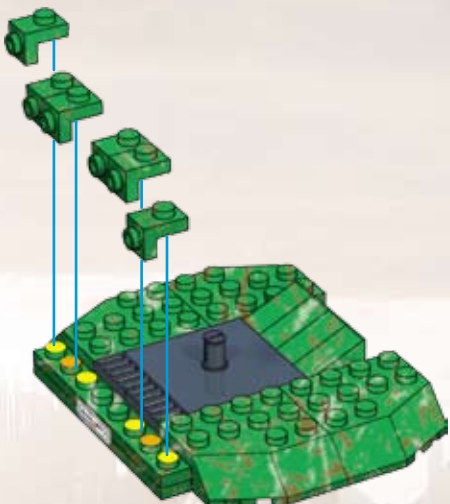

2

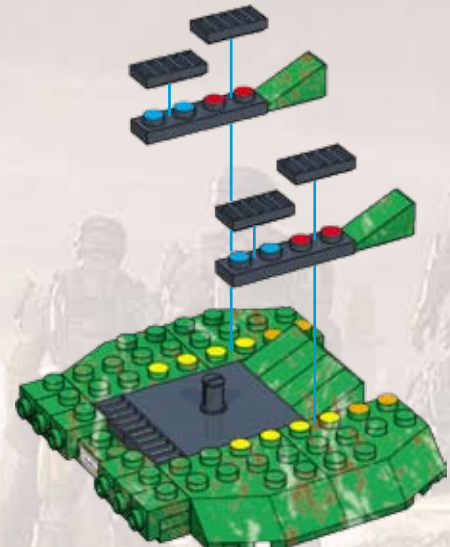

3

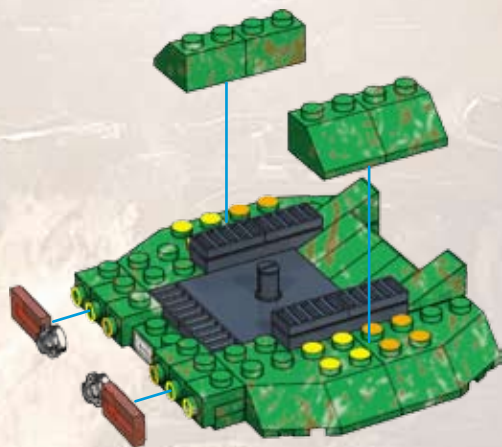

4



5

24

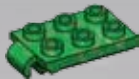

2X



1X

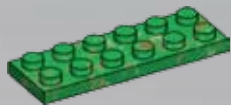

4X

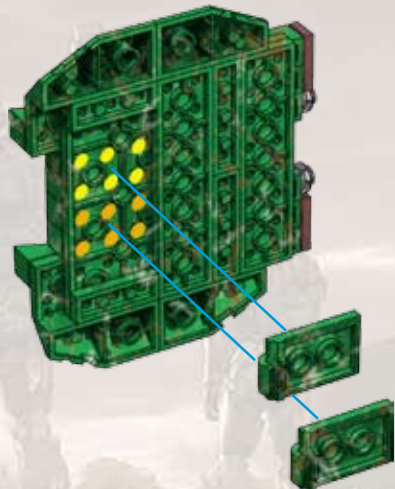

1

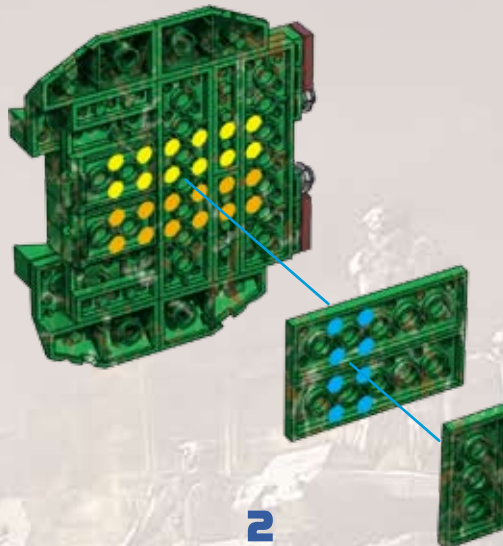

2

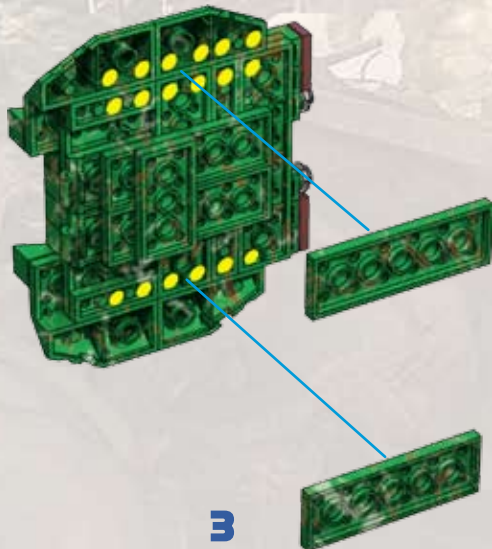

3



4

25

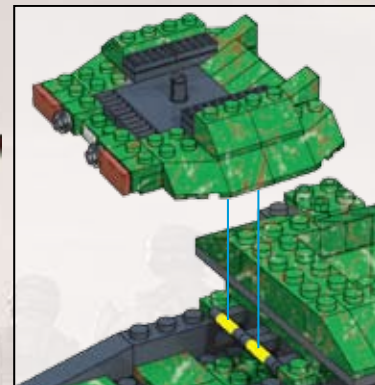

24

26



7
14
15

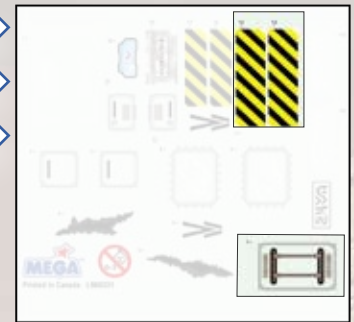

2

25





- EN** WARNING: Contains sharp points. Adult assembly required.
- ES** ADVERTENCIA: Contiene puntas muy agudas. Debe ser ensamblado por un adulto.
- FR** MISE EN GARDE: Contient des pièces à bout pointu. L'assemblage doit être fait par un adulte.
- DE** ACHTUNG: Enthält scharfe Kanten. Muss von Erwachsenen zusammengebaut werden.
- NL** WAARSCHUWING: Bevat scherpe punten. Vereist montage door volwassene.
- DA** ADVARSEL: Indeholder skarpe spidser. Montering af en voksen er obligatorisk.
- EL** ΠΡΟΕΙΔΟΠΟΙΗΣΗ: Περιέχει αιχμηρά σημεία. Απαιτείται σύνδεση από ενηλίκους.
- FI** VAROITUS: Sisältää teräviä osia. Kokoamiseen tarvitaan aikuinen.
- IT** ATTENZIONE: Contiene punte affilate. Deve essere montato da un adulto.
- NO** ADVARSEL: Spisse deler. Må settes sammen av voksne.
- PT** ADVERTENCIA: Contém pontas agudas. Requer montagem por adultos.
- SU** VARNING: Innehåller vassa spetsar. Bör monteras av en vuxen.
- JA** 警告：先の尖ったものが含まれています。組立は大人がしてください。
- ZH** 警告：含有尖刺。需由成人組裝。
- AR** تحذير: تحتوي على حواف حادة. يلزم أن يتم التجميع بمعرفة شخص بالغ.

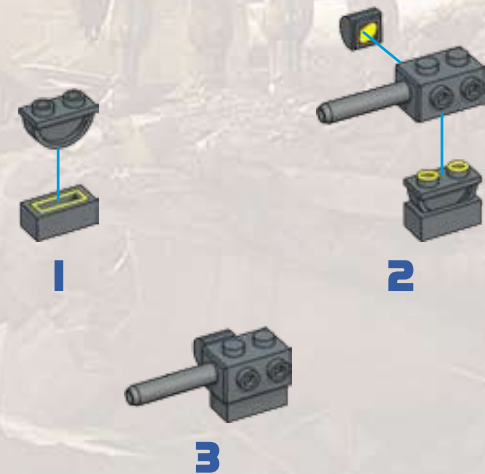
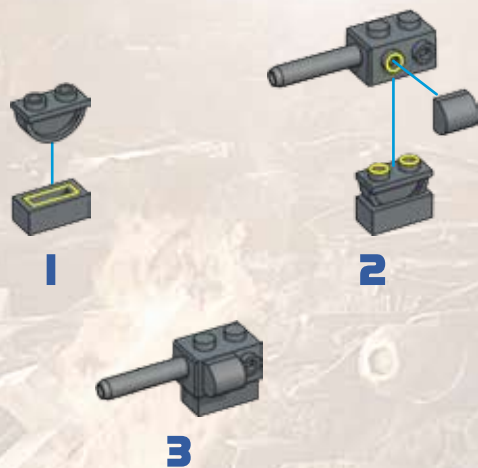



- EN** WARNING: Contains sharp points. Adult assembly required.
- ES** ADVERTENCIA: Contiene puntas muy agudas. Debe ser ensamblado por un adulto.
- FR** MISE EN GARDE: Contient des pièces à bout pointu. L'assemblage doit être fait par un adulte.
- DE** ACHTUNG: Enthält scharfe Kanten. Muss von Erwachsenen zusammengebaut werden.
- NL** WAARSCHUWING: Bevat scherpe punten. Vereist montage door volwassene.
- DA** ADVARSEL: Indeholder skarpe spidser. Montering af en voksen er obligatorisk.
- EL** ΠΡΟΕΙΔΟΠΟΙΗΣΗ : Περιέχει αιχμηρά σημεία. Απαιτείται σύνδεση από ενηλίκους.
- FI** VAROITUS: Sisältää teräviä osia. Kokoamiseen tarvitaan aikuinen.
- IT** ATTENZIONE: Contiene punte affilate. Deve essere montato da un adulto.
- NO** ADVARSEL: Spisse deler. Må settes sammen av voksne.
- PT** ADVERTENCIA: Contém pontas agudas. Requer montagem por adultos.
- SV** VARNING: Innehåller vassa spetsar. Bör monteras av en vuxen.
- JA** 警告：先の尖ったものが含まれています。組立は大人がしてください。
- ZH** 警告：含有尖刺。需由成人組裝。
- AR** تحذير: تحتوي على حواف حادة. يلزم أن يتم التجميع بمعرفة شخص بالغ.

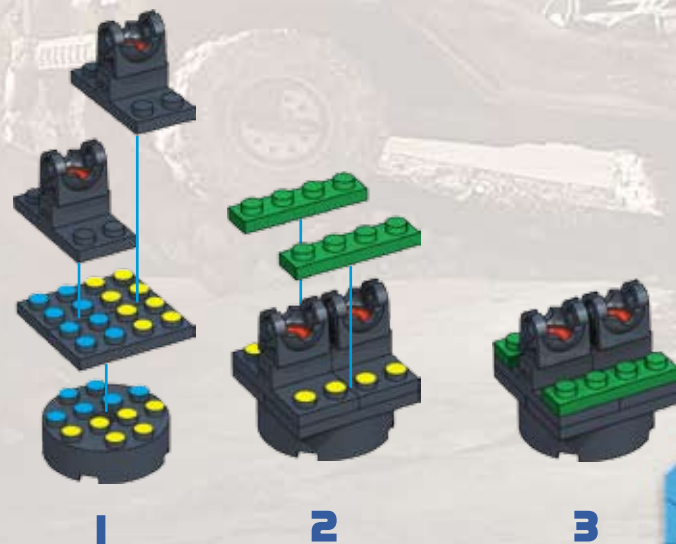

30

1X 1X 2X

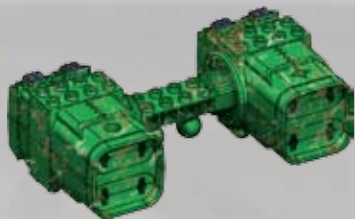

1X

12
13

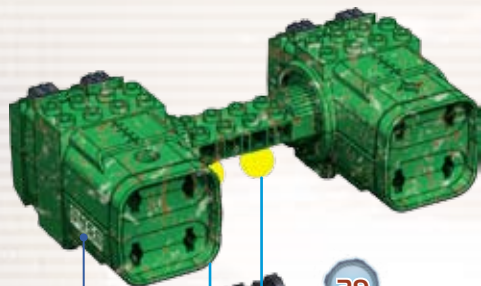

12

29

1

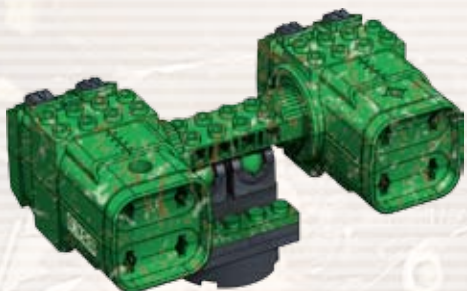

2

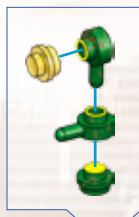

28

27

13



28

31



8X

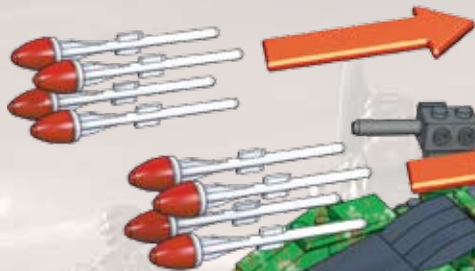

- 1 3 2 4 6
- 8 9 11 16 17

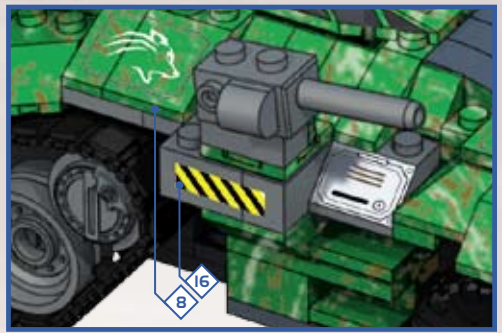
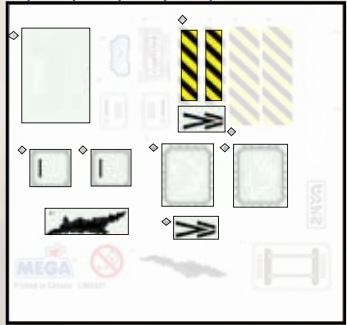

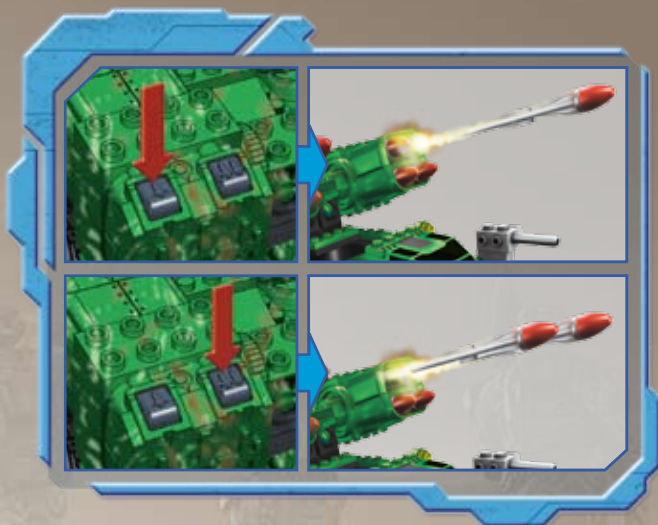

- EN CAUTION!** Do not aim at eyes or face.
- ES ¡ADVERTENCIA!** NO dirigir nunca los proyectiles hacia los ojos o la cara.
- FR ATTENTION!** Ne pas viser les yeux ou le visage.
- DE VORSICHT!** Nicht auf das Gesicht oder die Augen richten.
- NL LET OP:** Niet op ogen of gezicht richten.
- DA ADVARSEL!** Peg ikke i retning af øjne eller ansigt.
- EL ΠΡΟΣΟΧΗ!** Να μην σκοπεύετε προς τα μάτια ή το πρόσωπο.
- FI VARO!** Älä tähtää silmiin tai kasvoihin.
- IT Attenzione!** Non puntare verso gli occhi o il viso.
- NO FORSIKTIG!** Sikt ikke mot øyne eller ansikt.
- PT ATENÇÃO:** Não apontar para os olhos ou o rosto.
- SV VAR FÖRSIKTIG!** Rikta inte med ögon eller ansikte.
- JA 注意!** 目や顔に使用しないで下さい。
- ZH 警告!** 不要对准眼睛或脸。
- AR تنبيه!** لا توجه للعينين أو الوجه

Use only the projectiles included with this toy.
 Utilizar solamente los proyectiles incluidos con el juguete.
 Utiliser seulement les projectiles fournis avec le jouet.
 Nur die mit dem Spielzeug mitgelieferten Projektile verwenden.
 Alleen de met het speelgoed bijgeleverde projectielen gebruiken.
 Utilizzare soltanto i proiettili forniti con questo giocattolo.
 Usar somente os projéteis incluídos com este brinquedo.
 استخدم فقط الفذيفة المرافقة لهذه اللعبة



HALO WARS™

THE AUTHENTIC COLLECTOR'S SERIES

96833



UNSC Marine
Marines UNSC
Marines du CSNU

UNSC Marine
UNSC Marines
Marines dell'UNSC
Soldados de UNSC



Covenant Hunter
Hunter Covenant
Alianza-Hunter
Verdragshunter
Hunter di Covenant
Hunter dos Covenant



CAMOUFLAGE
CAMOUFLAJE
CAMOUFLAGE



NEU: TARNEFFKT
NEU: CAMOUFLAGE-EFFKT
NUOVO: EFFETTO MIMETICO
NOVO: EFFETTO CAMUFLAGEM



© 2009, MEGA Brands Inc.
 ® and ™ denote trademarks of MEGA Brands Inc.
 ® y ™ designan la marca registrada y la marca comercial de MEGA Brands Inc.
 ® et ™ désignent des marques de commerce de MEGA Brands Inc.
 ® und ™ sind Markenzeichen der Firma MEGA Brands Inc.
 ® en ™ duiden op handelsmerken van MEGA Brands Inc.
 ® e ™ indicano dei marchi depositati di MEGA Brands Inc.
 ® e ™ denotam marcas registradas de MEGA Brands Inc.



Printed in Canada D968331

Collect them all! /
 Verzamel ze allemaal! /
 Coleccionelos todos! /
 Collezionateli tutti! /
 Hele alle bij elkaar!

96823

96801

96818

96807

96845