



SEA RESCUE

9741



MEGA BLOKS AGES/AÑOS
7+

⚠ WARNING:
CHOKING HAZARD - Small Parts.
Not for children under 3 years



Color chart.
 Charte de couleurs.
 Cuadro cromático.
 Diagramma colorimetrico.

Färgtabell.
 Kleurkaart.
 カラーチャート
 彩圖



Active step / Étape active / Etapa activa / Istruzione attuale
 Aktiv skede / Volgende stap / 現在の手順 / 現段階

Previous step / Étape précédente / Etapa precedente / Istruzione precedente
 Föregående skede / Vorige stap / 以前の手順 / 前段階



Adult assistance is required. / L'aide d'un adulte est requise. / Necesita ayuda de un adulto. / L'aiuto di un adulto è richiesto. /
 Hjälp av en vuxen är nödvändig. / Hulp van volwassenen is gewenst. / 大人の操作が必要です。 / مطلوب المساعدة من الكبار. / 小零件有窒息危险。

WARNING:

Choking hazard— Small parts.
 Not for children under 3 years.

AVERTISSEMENT:

Risque de suffocation. Ne convient pas à un enfant de moins de 3 ans - contient de petits éléments.

ADVERTENCIA:

Peligro de asfixia. No recomendado para niños menores de 3 años—contiene piezas pequeñas.

AVVERTENZA:

Rischio di soffocamento. Non adatta ad un bambino di età minore ai 36 mesi. Contiene parti piccole - non ingerire.

VARNING:

Risk för kvävning. Ikke egnet til barn under 3 år - inneholder smådelar.

WAARSCHUWING:

Stikgevaar. Niet geschikt voor kinderen onder 3 jaar - I.v.m. kleine onderdelen.

注意:

飲み込むと危険です。小さいパーツがあるので、3才以下の幼児には与えないでください。

不适于三岁以下儿童。

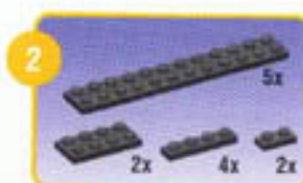

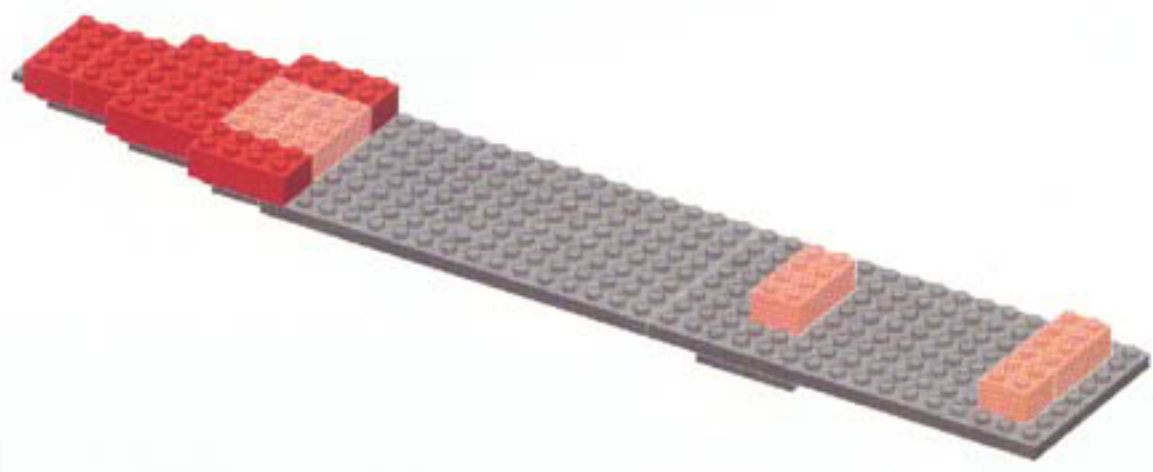
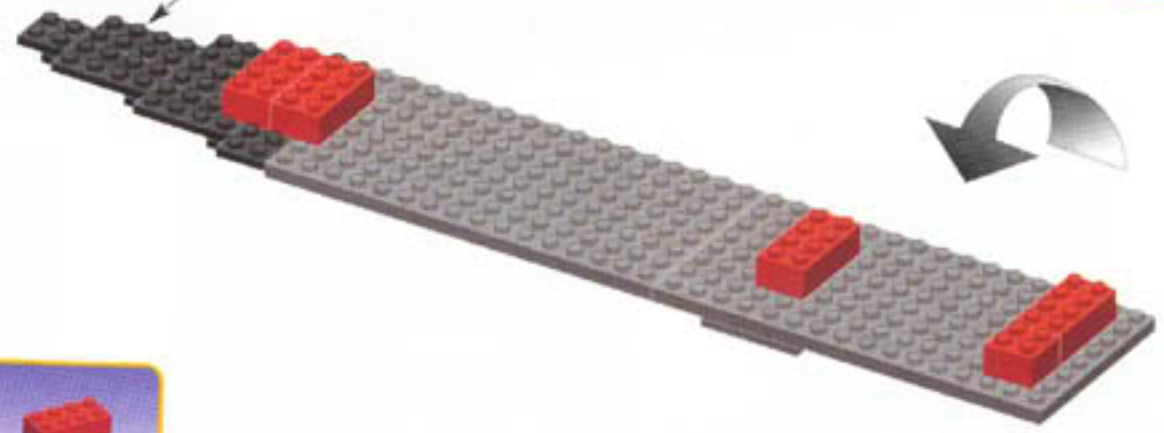
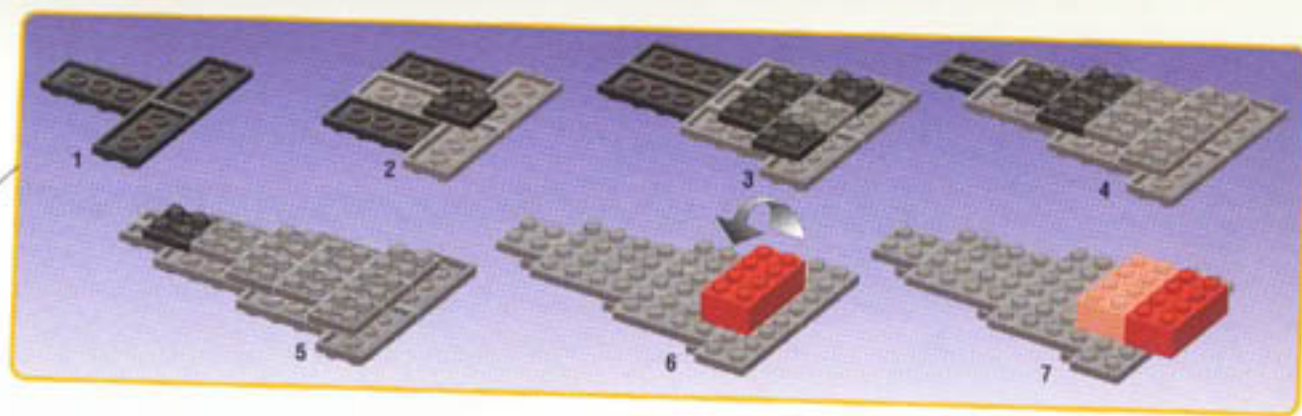



Active step / Étape active / Etapa activa / Istruzione attuale
 Aktiv skede / Folgende stap / 次, 以下, 3 次 / 次, 以下, 3 次

Previous step / Étape précédente / Etapa precedente / Istruzione precedente
 Föregående skede / Vorige stap / 次, 前, 1 次 / 次, 前, 1 次



5



32x

3x

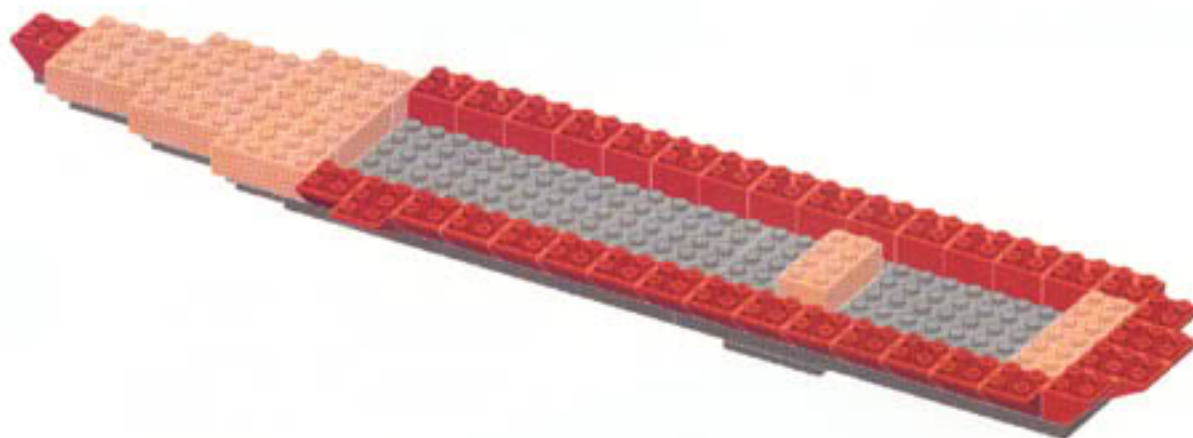

6



21x

5x

1x

2x

2x

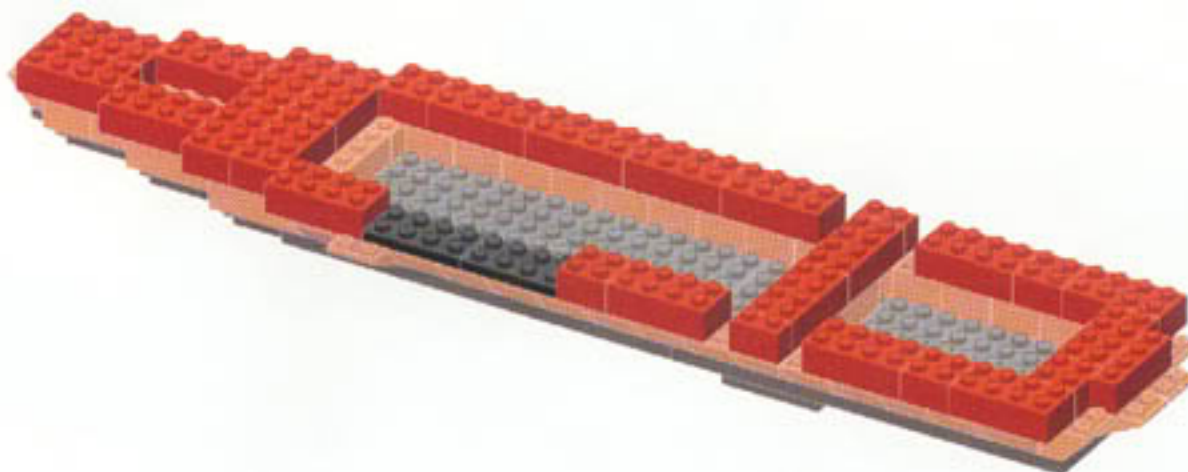

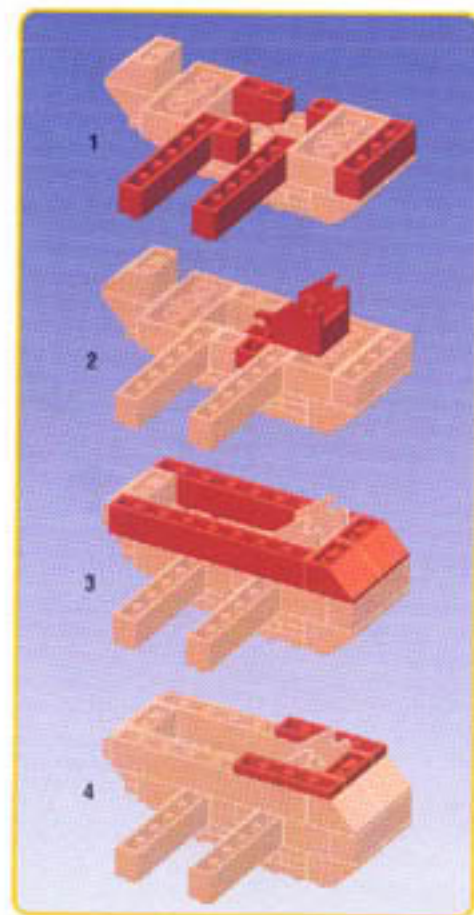
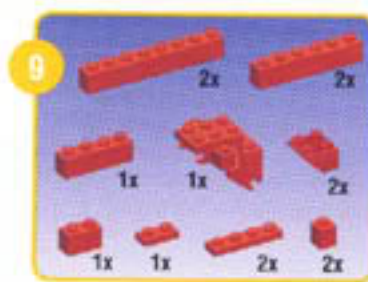
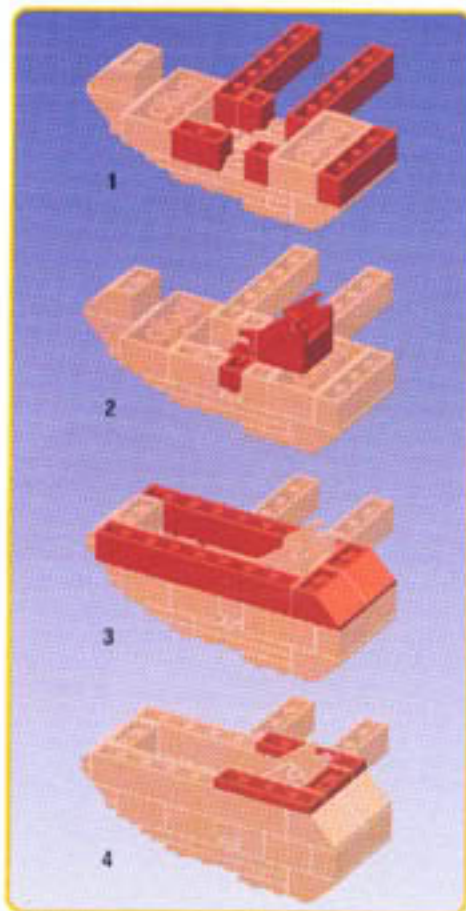
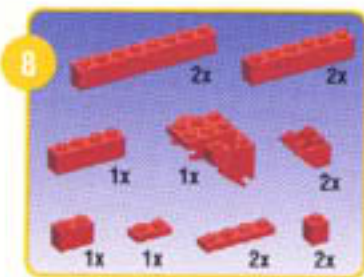
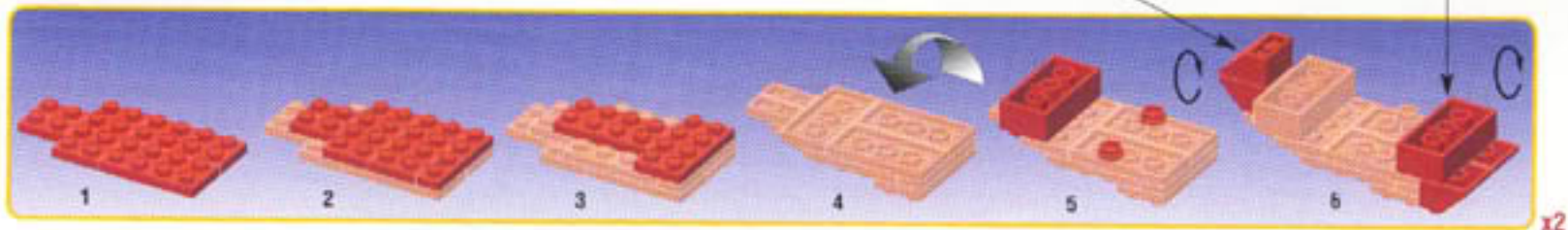



Active step / Étape active / Etapa activa / Istruzione attuale
 Aktiv skede / Folgende stap / Aktiv skede / Folgende stap / Aktiv skede / Folgende stap

Previous step / Étape précédente / Etapa precedente / Istruzione precedente
 Föregående skede / Vorige stap / Föregående skede / Vorige stap / Föregående skede / Vorige stap

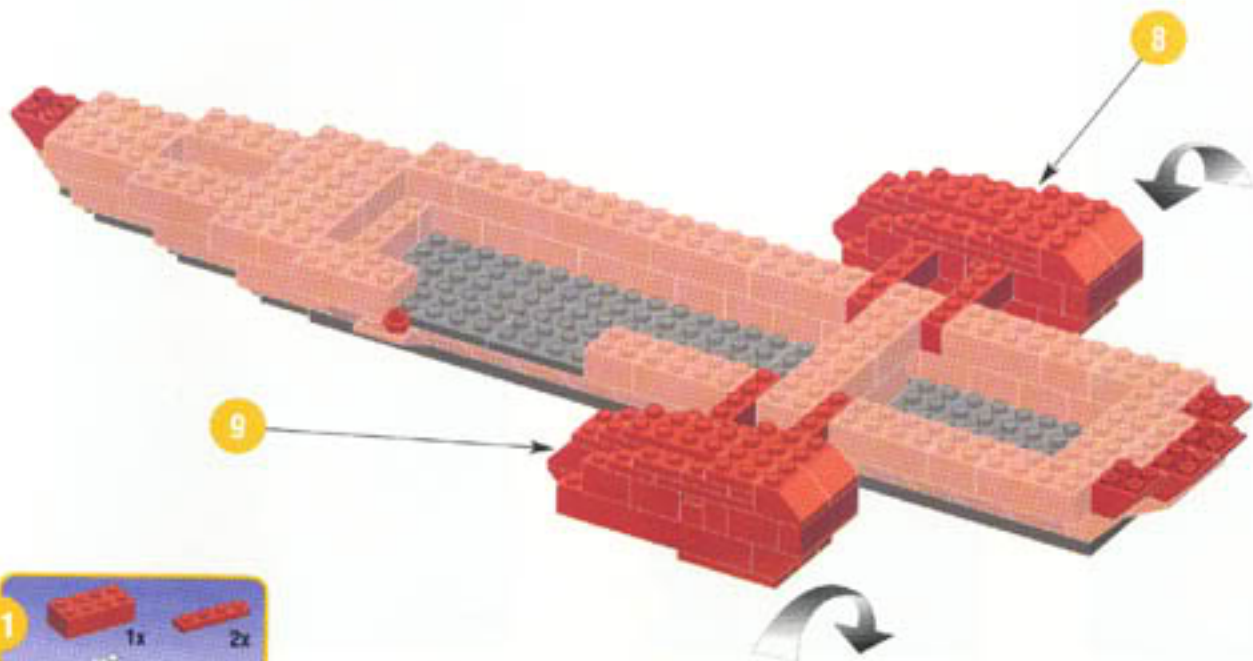

9

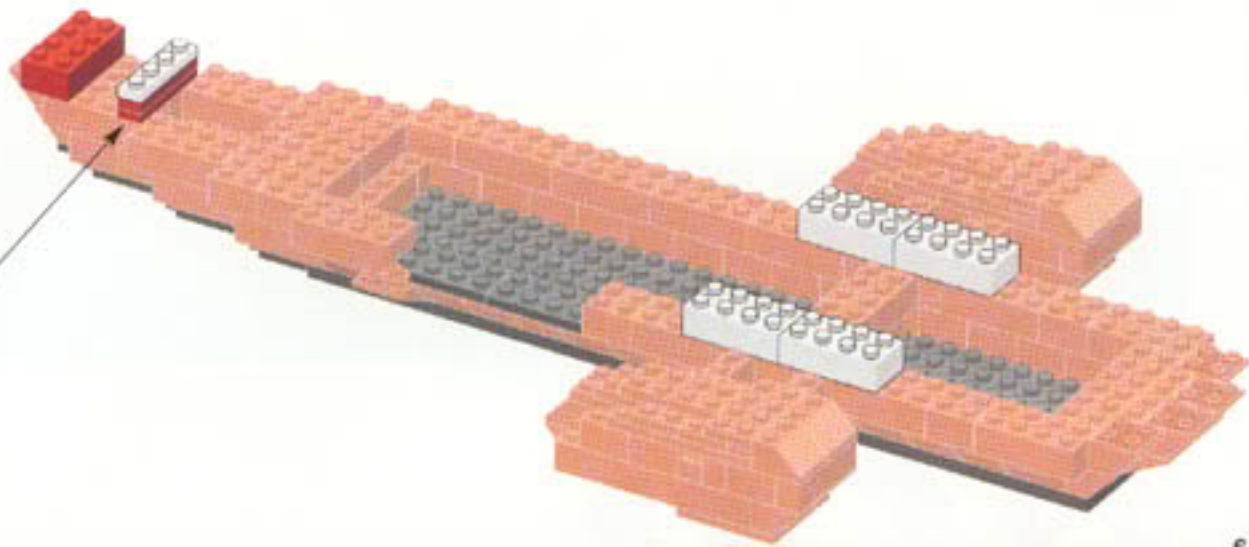
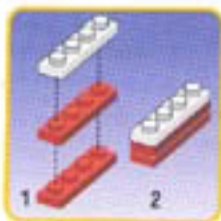

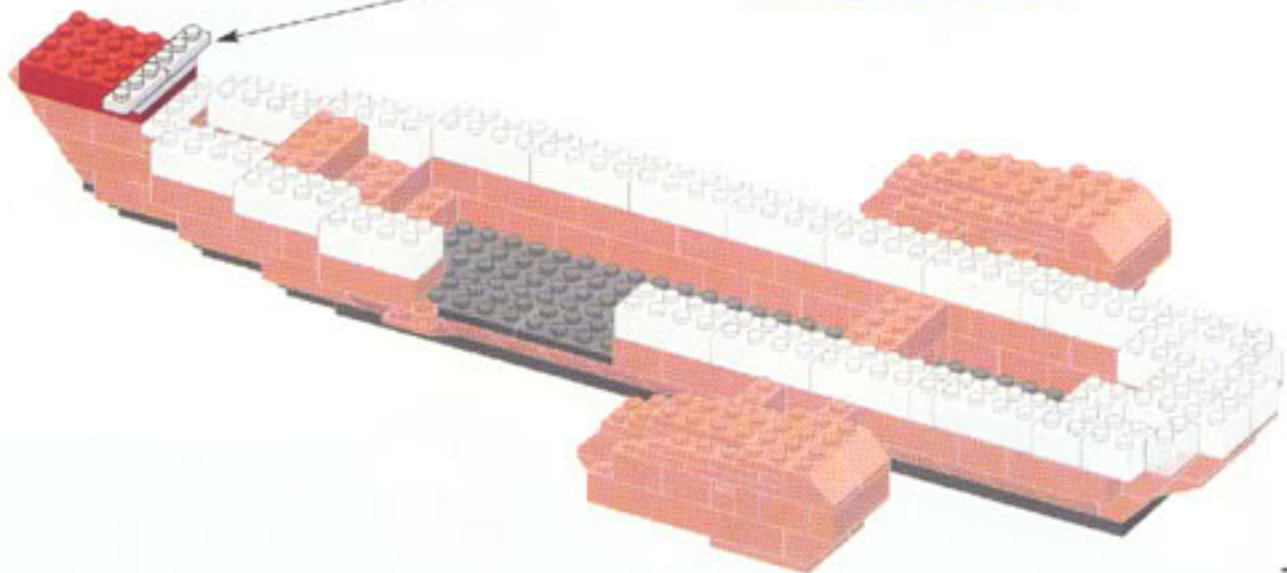
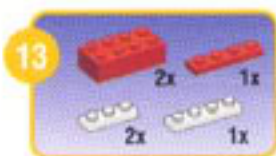
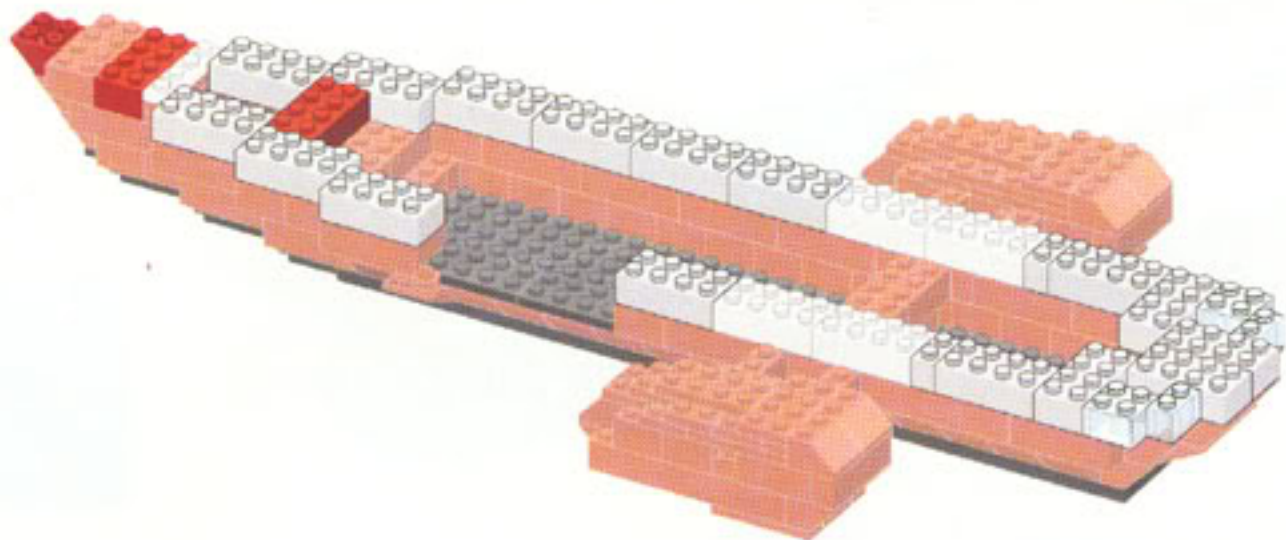
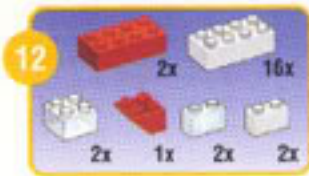



Active step / Étape active / Etapa activa / Istruzione attuale
 Aktiv skede / Folgende stap / 次, 下一个步骤 / 次, 下个步骤

Previous step / Étape précédente / Etapa precedente / Istruzione precedente
 Föregående skede / Vorige stap / 次, 前一个步骤 / 前一个步骤

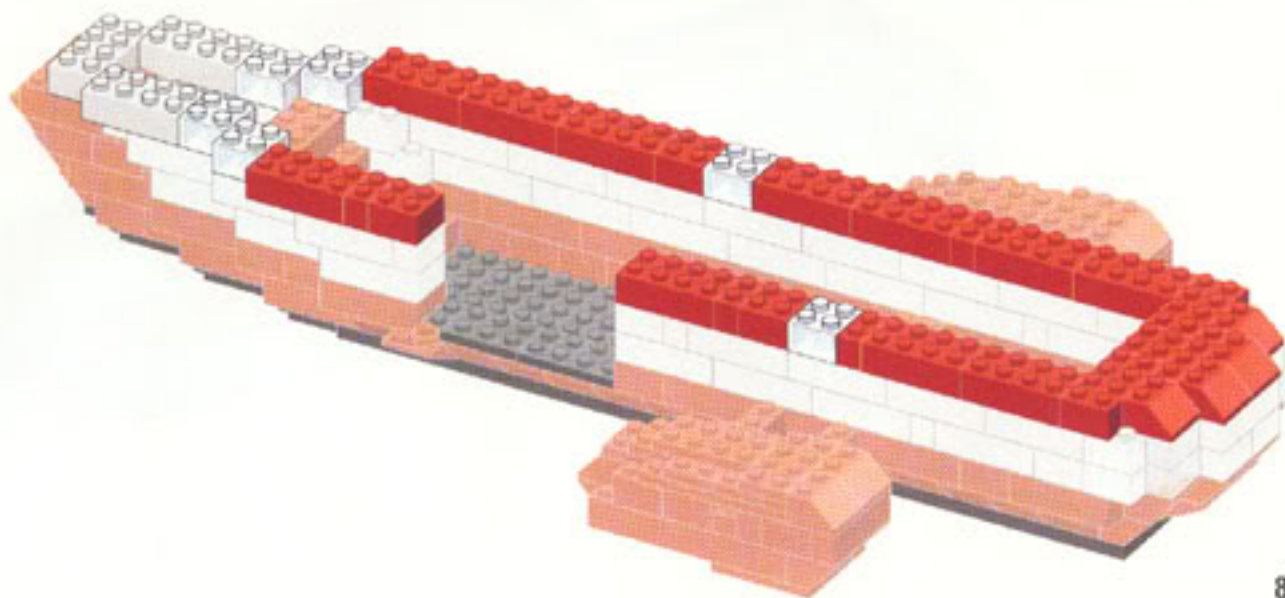
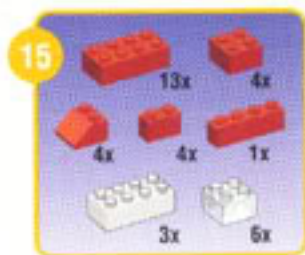
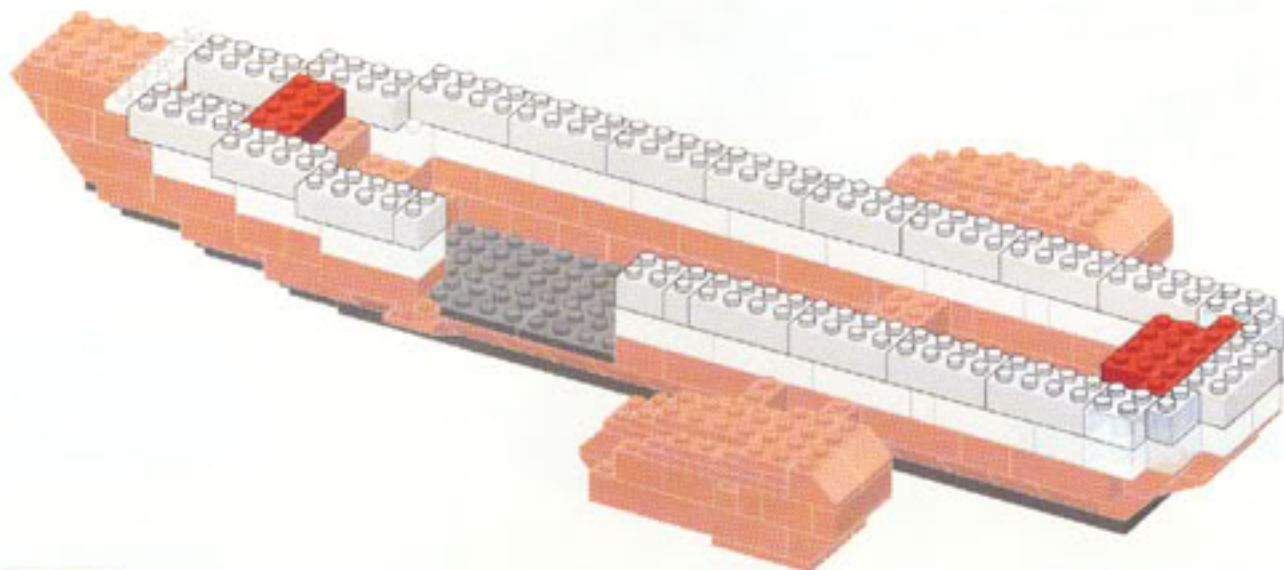
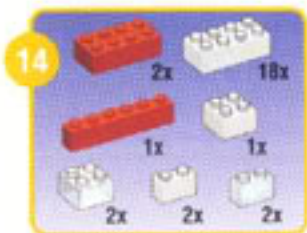

16

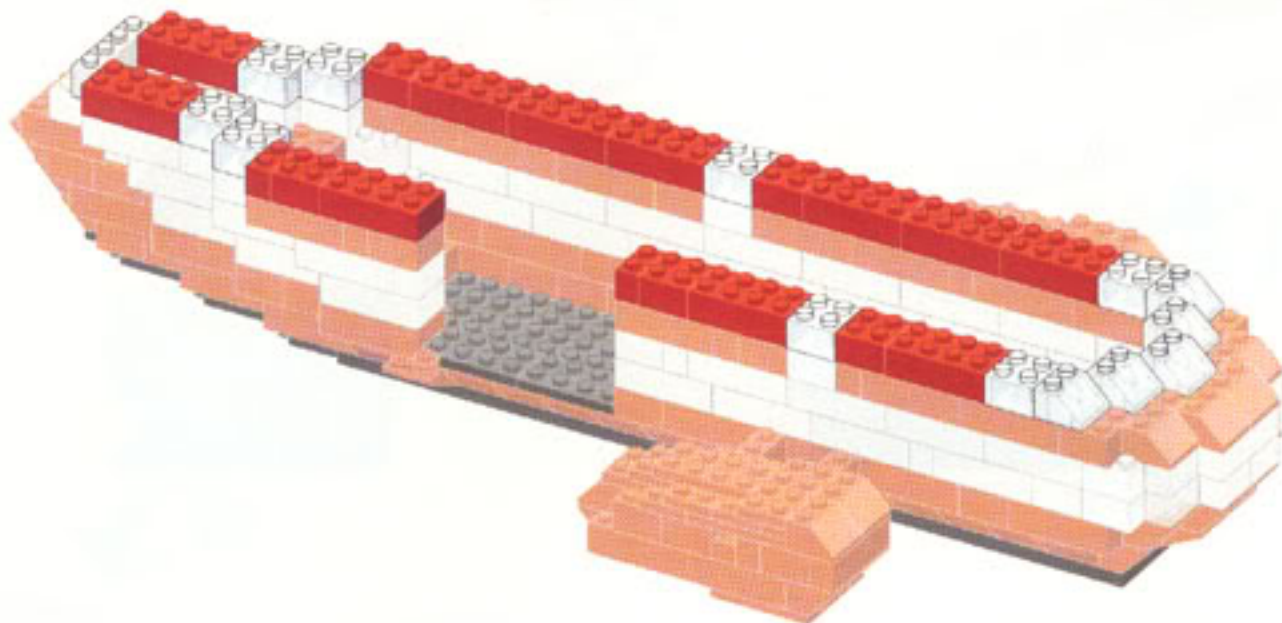

17



18

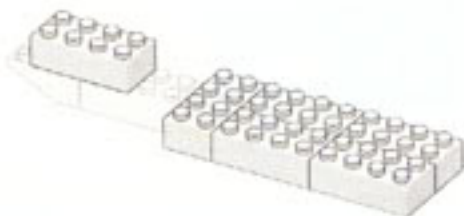

19



20

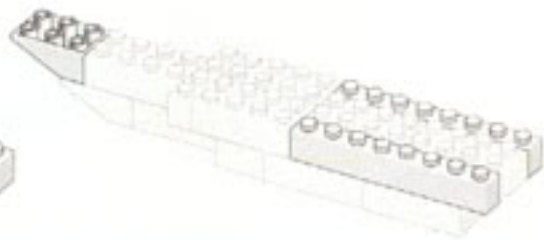



Active step / Étape active / Etapa activa / Istruzione attuale
Aktiv skede / Folgende stap / Aktiv skede / 步骤

Previous step / Étape précédente / Etapa precedente / Istruzione precedente
Føregående skede / Vorige stap / 前一步

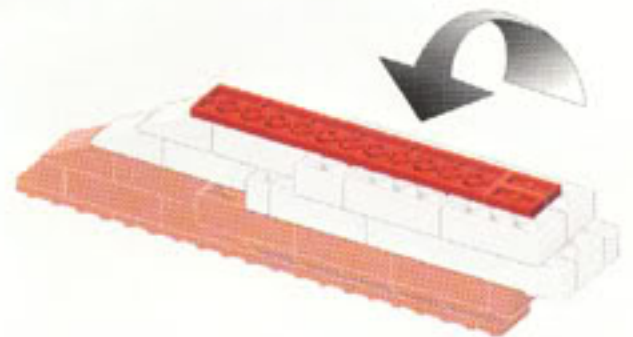
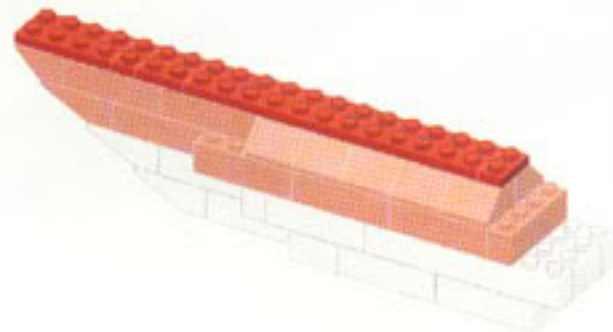
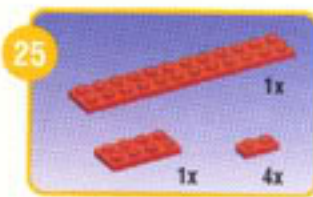
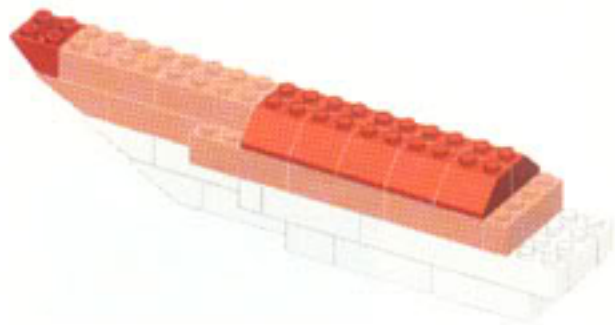
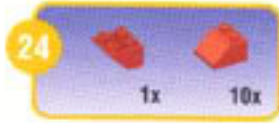
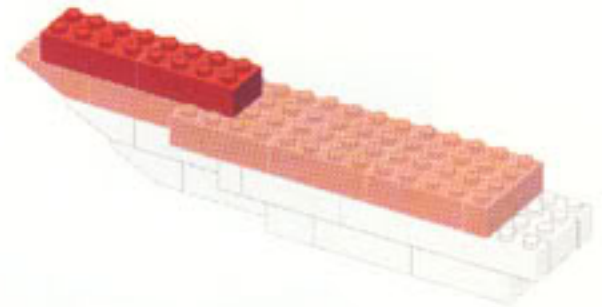
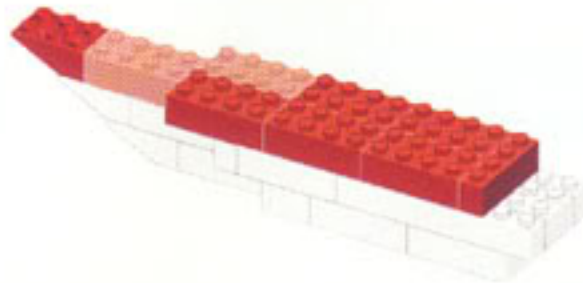
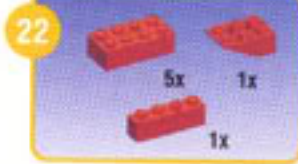
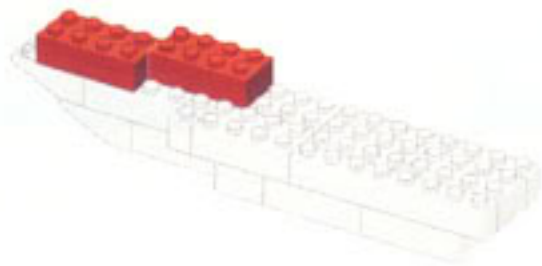

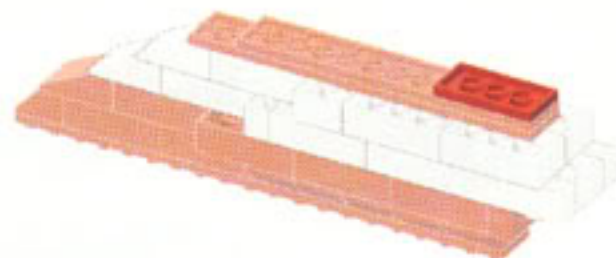
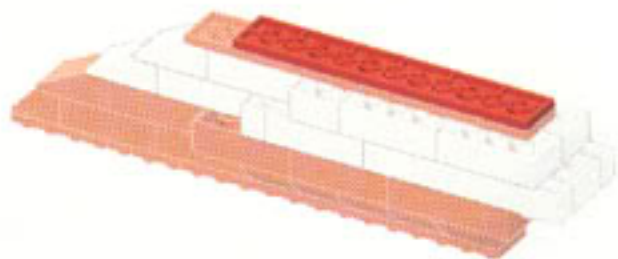

29

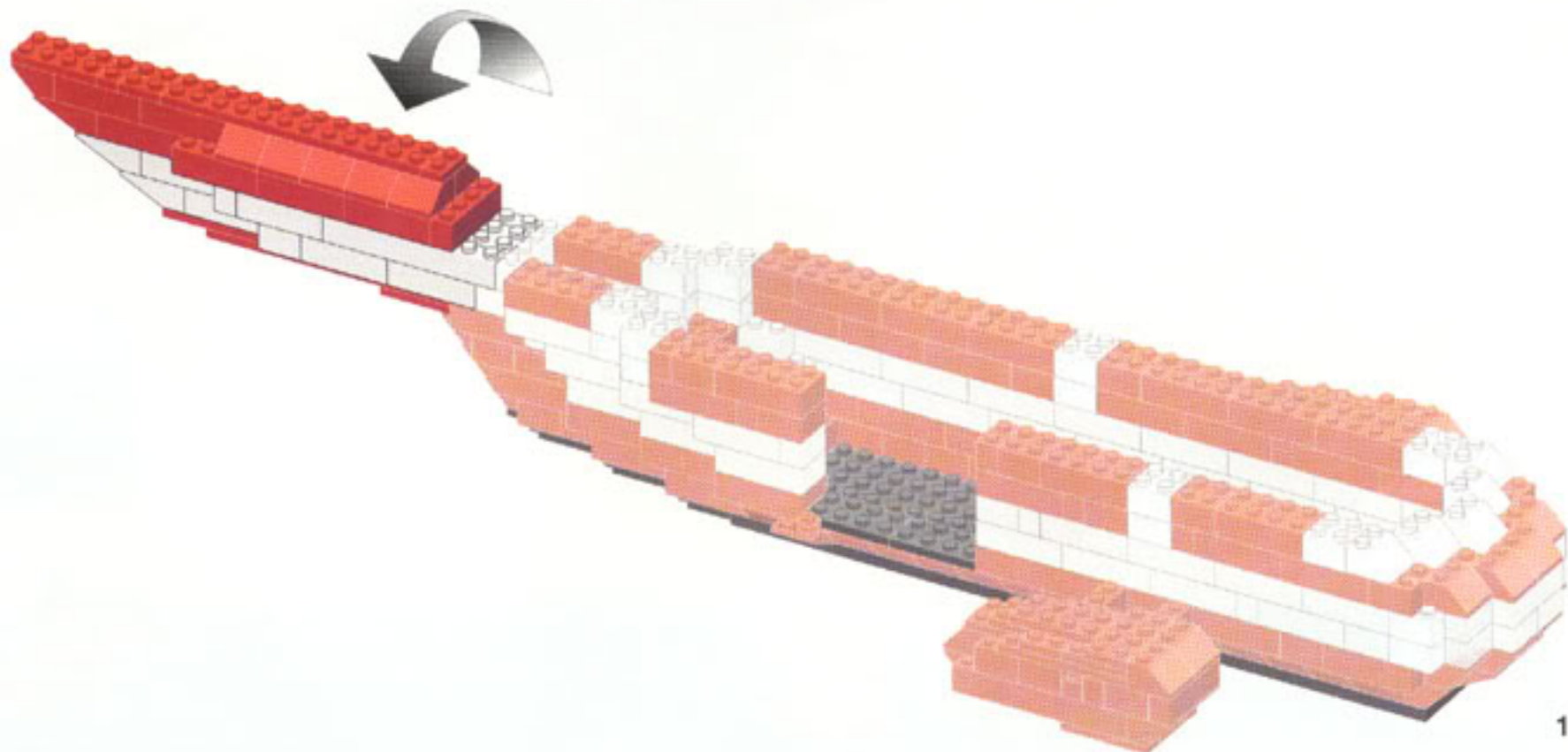



Active step / Étape active / Etapa activa / Istruzione attuale
 Aktiv skede / Folgende stap / 次 的 步 骤 / 現 在 的 步 骤

Previous step / Étape précédente / Etapa precedente / Istruzione precedente / Föregående skede / Vorige stap / 上 一 步 的 步 骤 / 前 一 步 的 步 骤



30

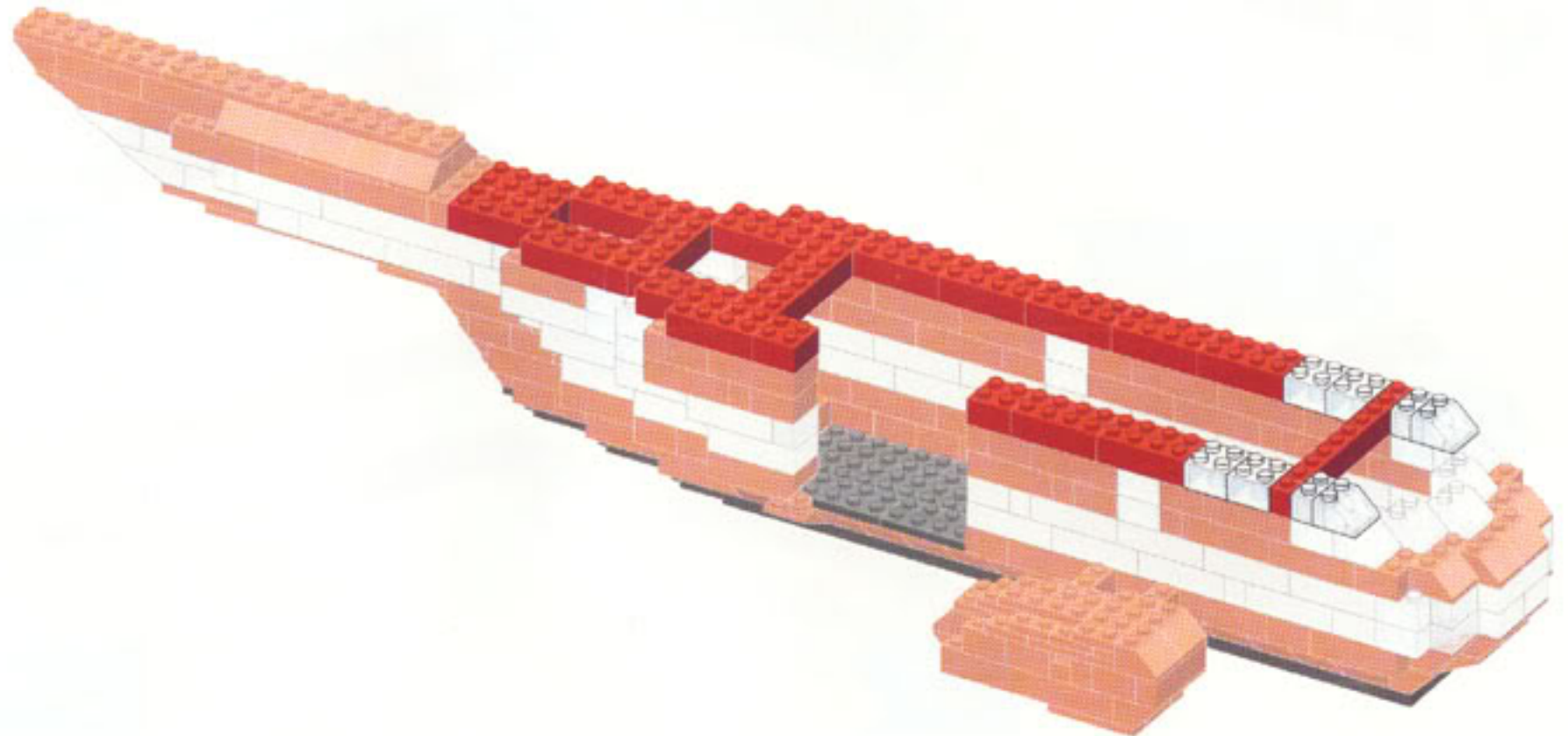
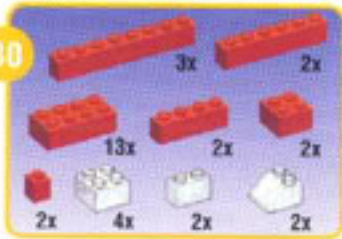

31

5x
5x
2x
2x

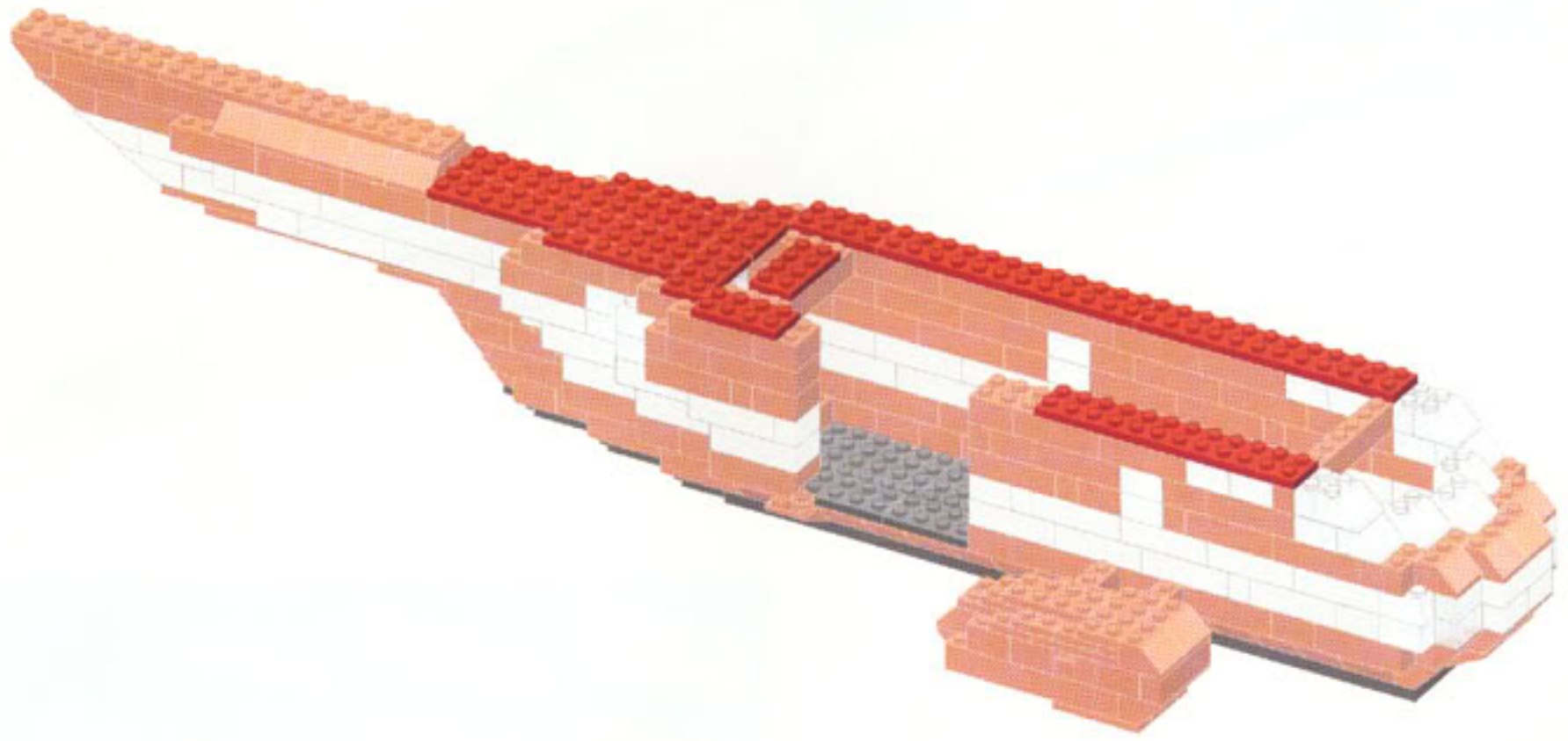



Active step / Étape active / Etapa activa / Istruzione attuale
Aktiv skede / Folgende stap / 下一个步骤 / 此段段

Previous step / Étape précédente / Etapa precedente / Istruzione precedente
Følgende skede / Vorige stap / 从前的步骤 / 前段段



32



36x

2x

2x

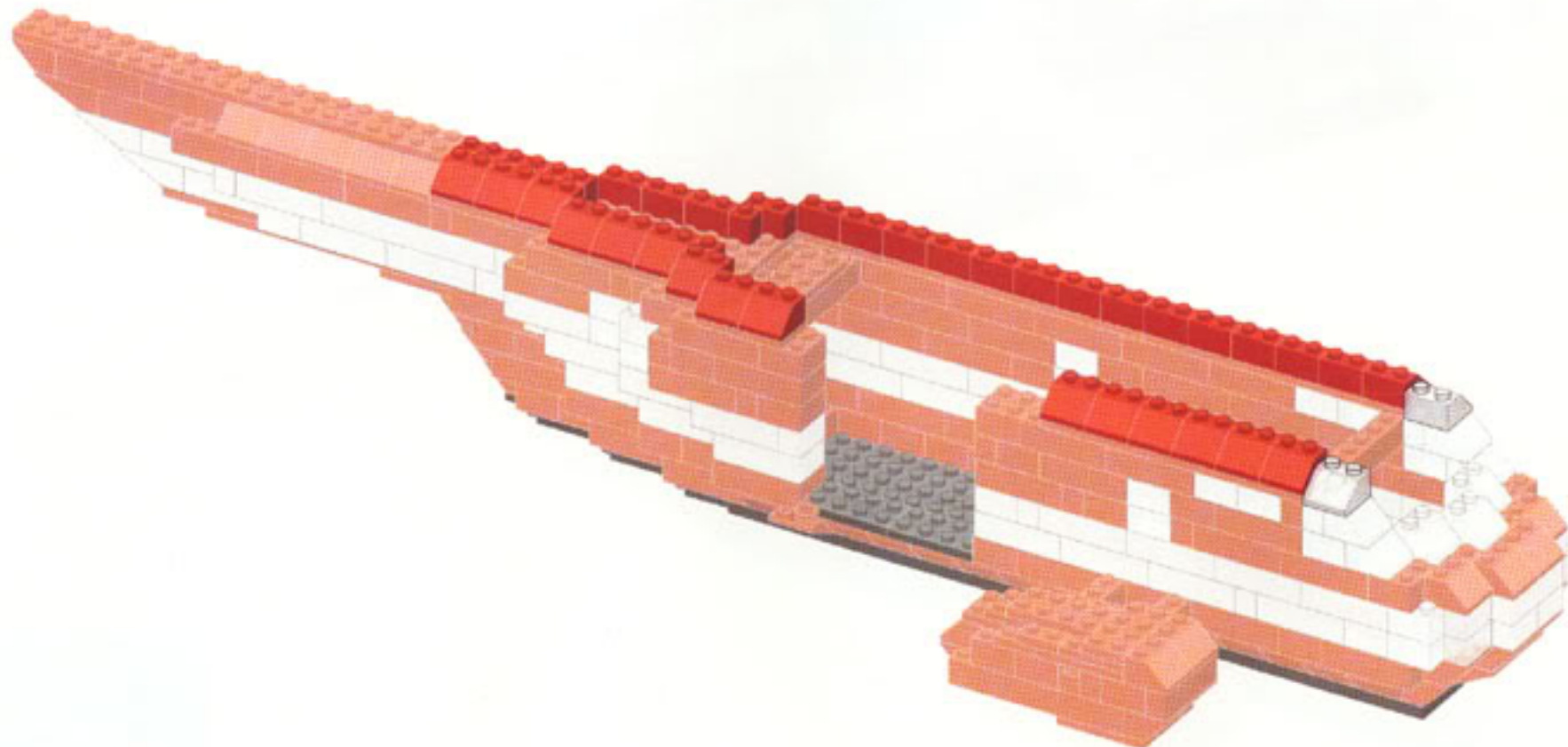

33

- 1x (red 1x8 Technic brick)
- 2x (white 1x8 Technic brick)
- 1x (red 1x4 Technic brick)
- 6x (red 1x2 Technic brick)
- 1x (red 1x1 Technic brick)
- 1x (red 1x1 Technic brick)
- 2x (white 1x1 Technic brick)
- 5x (red 1x1 Technic brick)
- 1x (red 1x1 Technic brick)
- 1x (red 1x1 Technic brick)
- 4x (white 1x1 Technic brick)
- 4x (red 1x1 Technic brick)
- 3x (red 1x1 Technic brick)
- 1x (red 1x1 Technic brick)
- 4x (red 1x1 Technic brick)
- 3x (red 1x1 Technic brick)

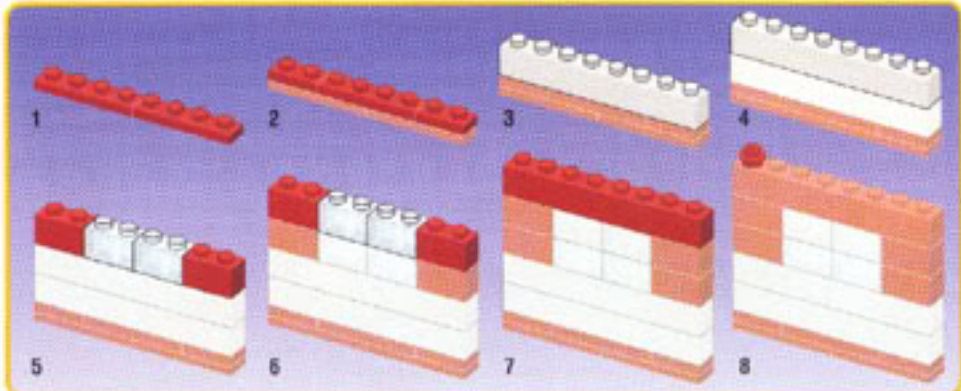
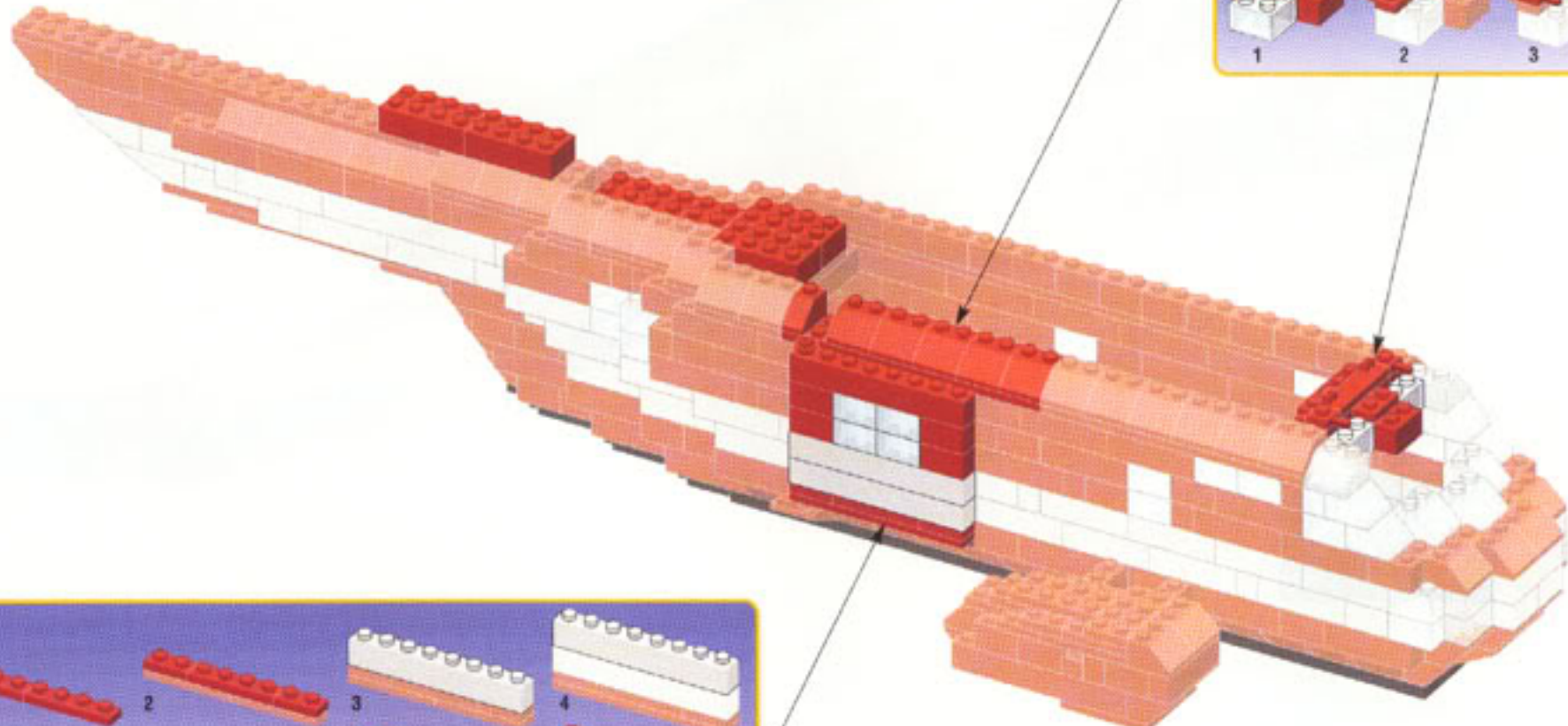
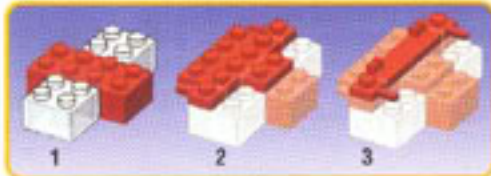
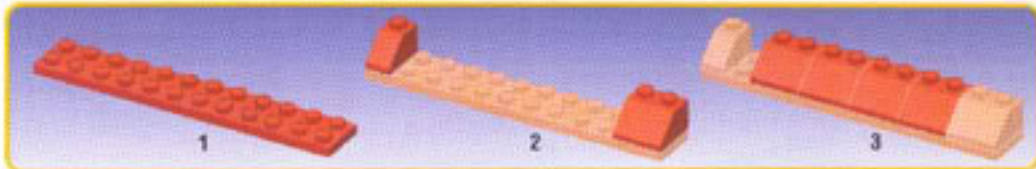



Active step / Étape active / Etapa activa / Istruzione attuale
 Aktiv skede / Folgende stap / 下一个步骤 / 现况图

Previous step / Étape précédente / Etapa precedente / Istruzione precedente
 Föregående skede / Yorige stap / 上一个步骤 / 前况图



34

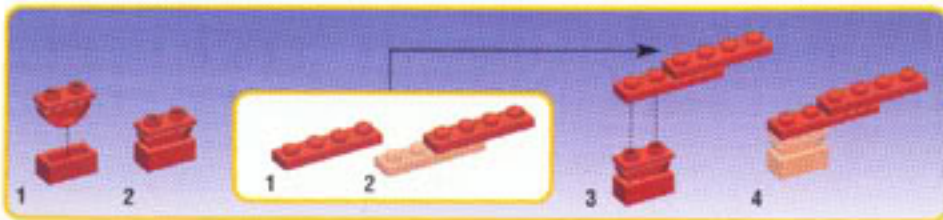
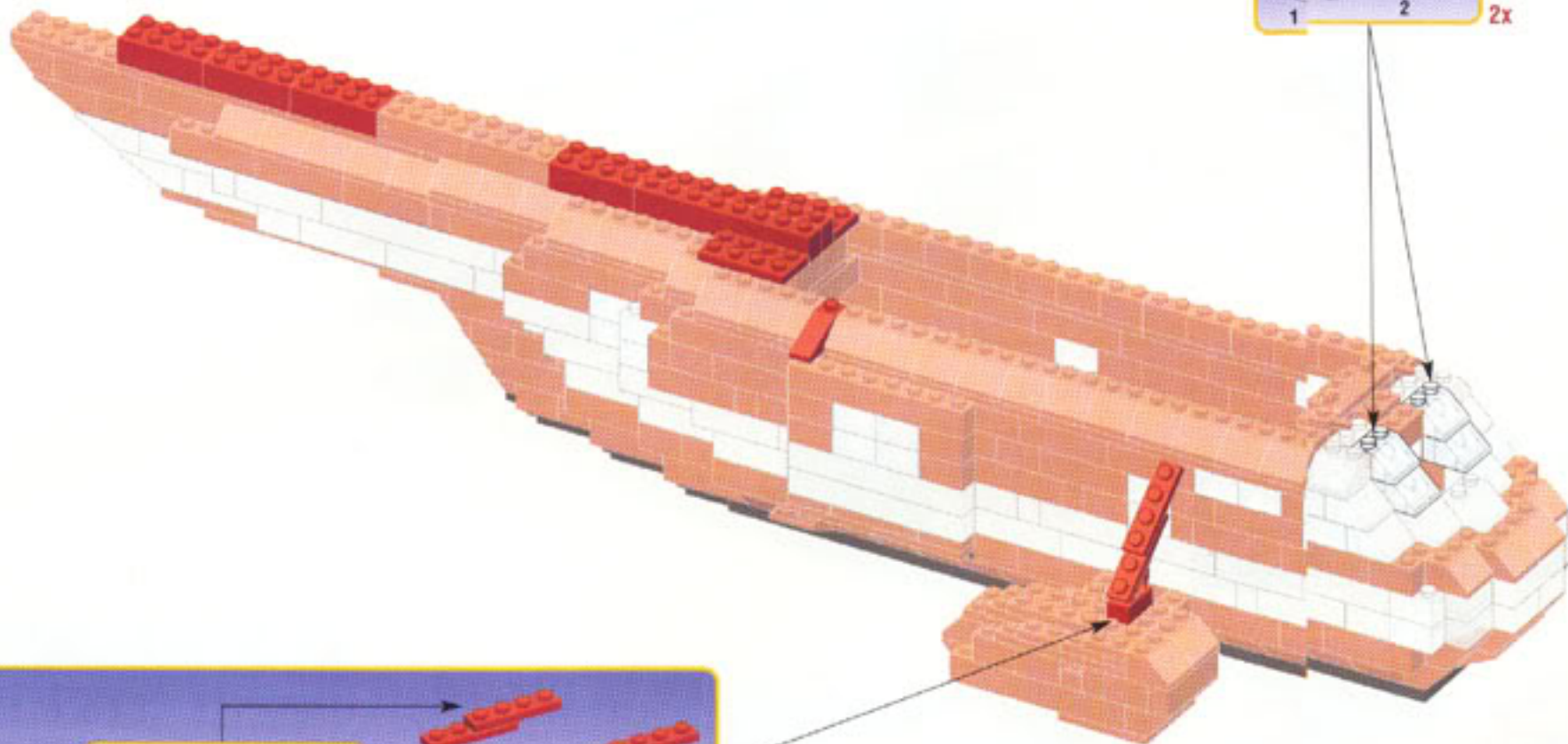
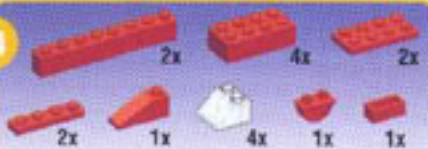

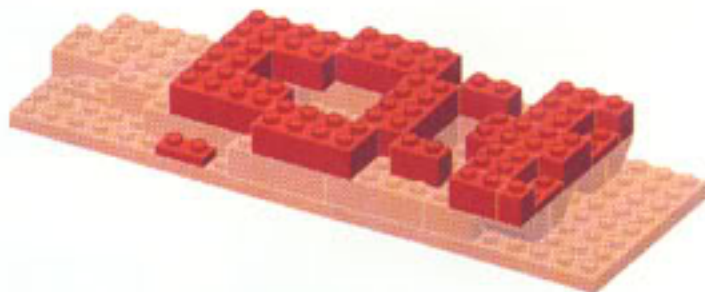
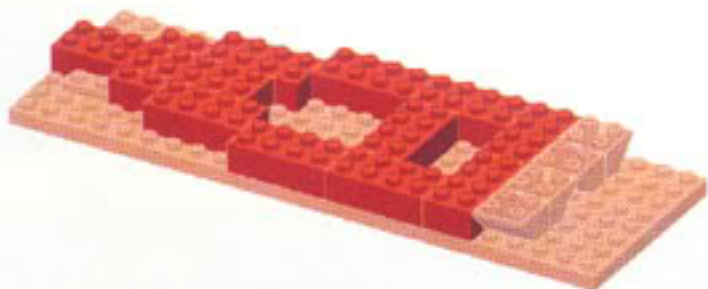
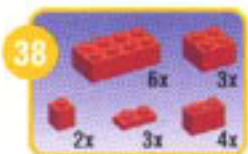
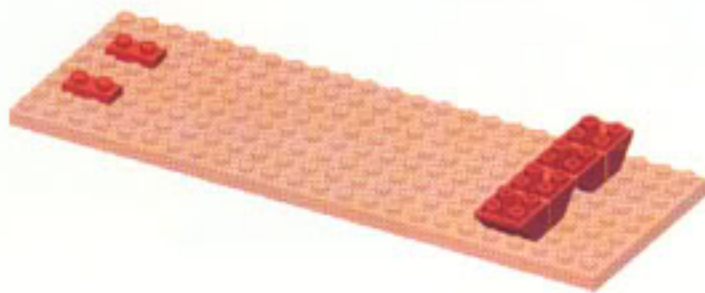
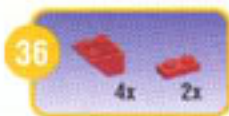
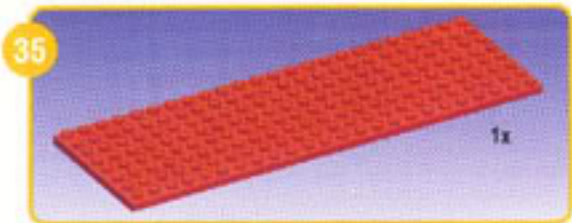



Active step / Étape active / Etapa active / Istruzione attuale
 Aktiv skede / Folgende stap / 下一个步骤 / 现阶段

Previous step / Étape précédente / Etapa precedente / Istruzione precedente
 Foregående skede / Yorige stap / 上一个步骤 / 前阶段



39

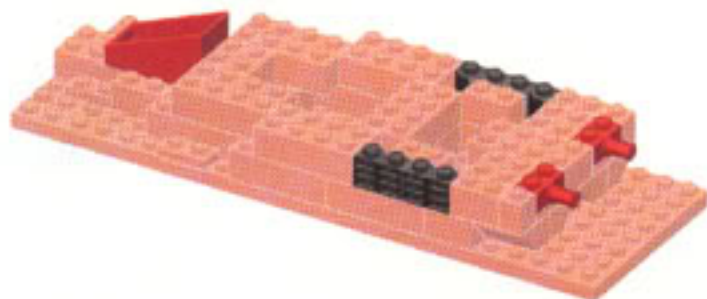

40

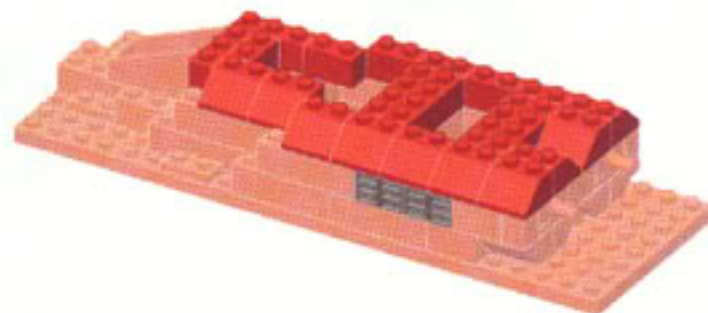

41

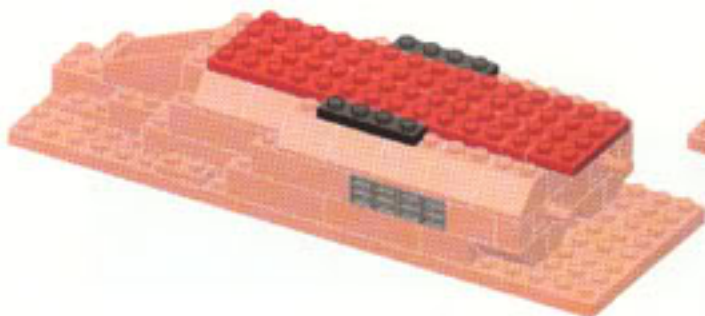

42

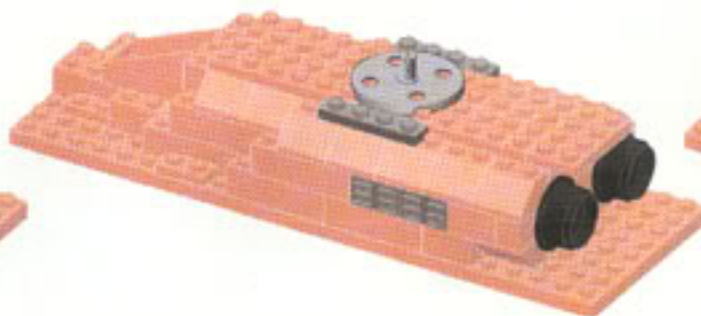

43

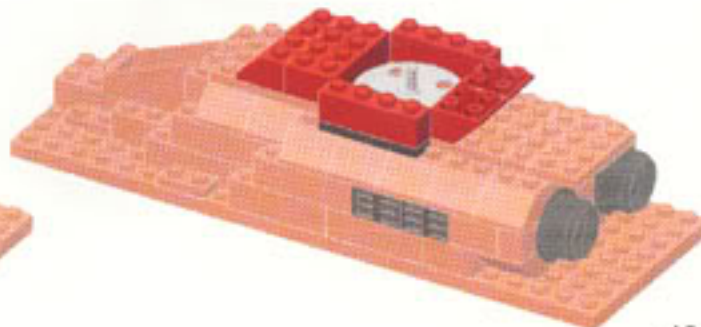

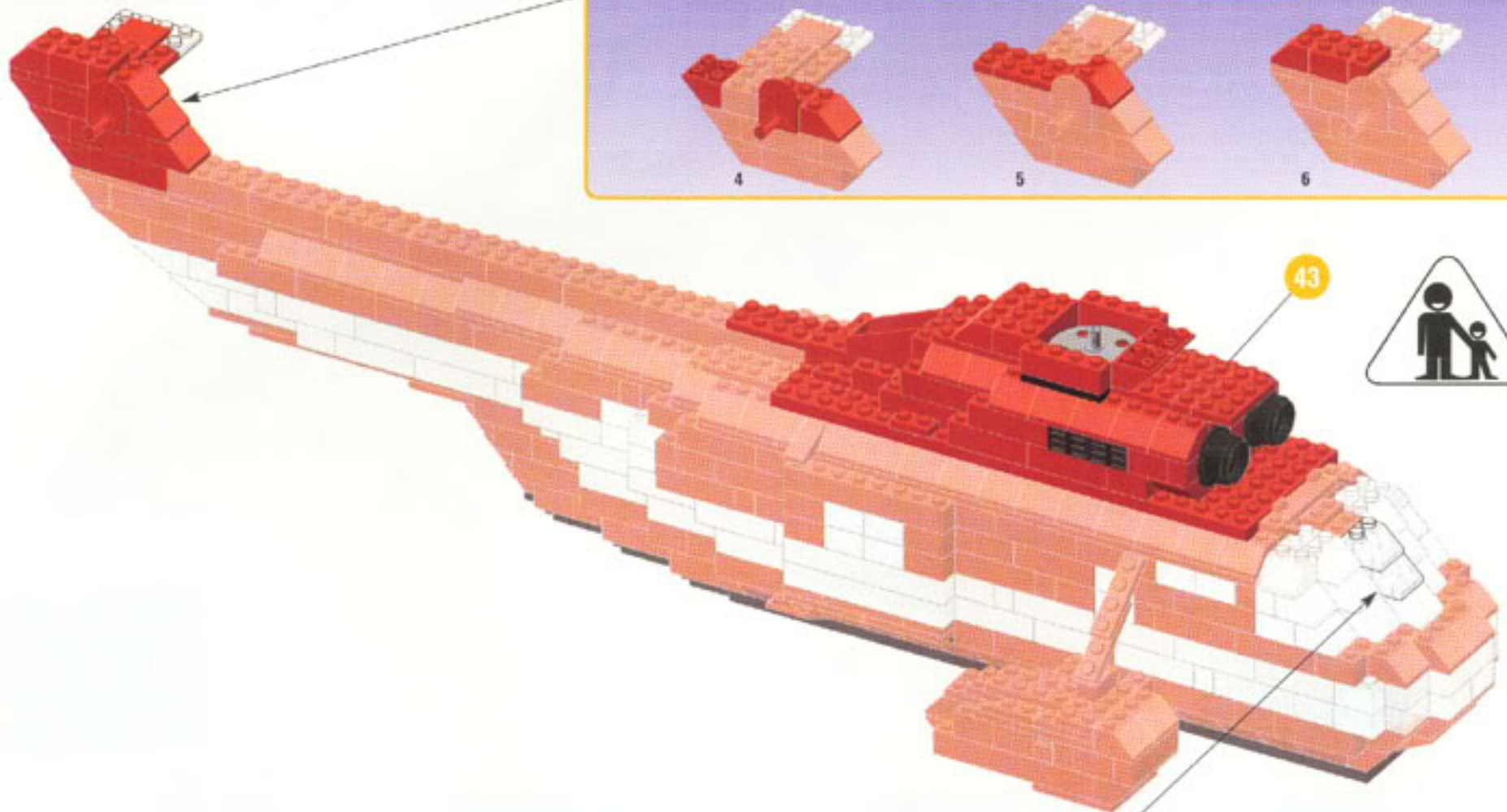
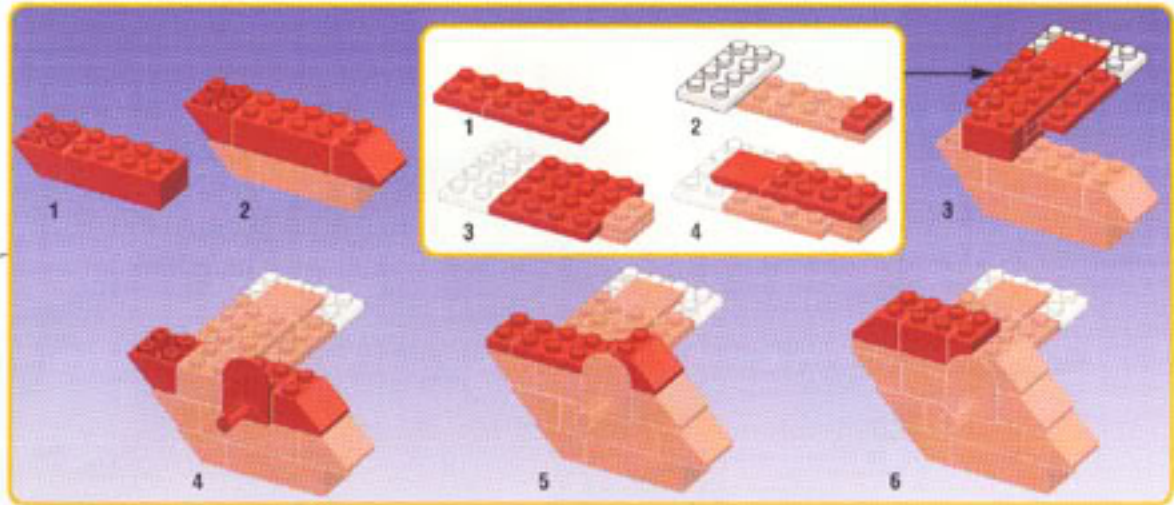
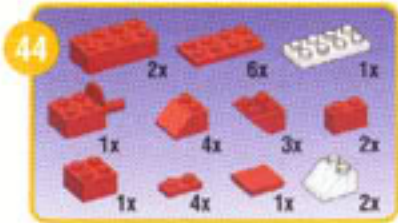



Active step / Étape active / Etapa activa / Istruzione attuale
Aktiv skede / Folgende stap / 現正步驟 / 現正階段

Previous step / Étape précédente / Etapa precedente / Istruzione precedente
Föregående skede / Vorige stap / 前一步驟 / 前一階段



45

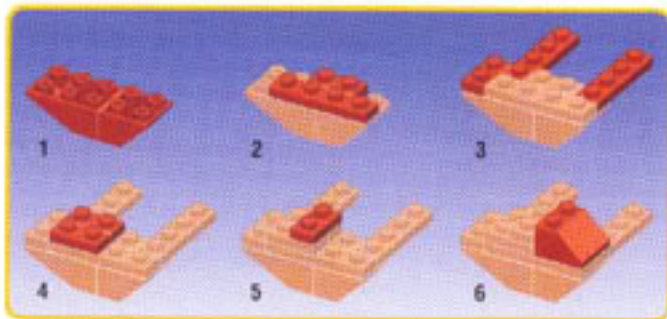
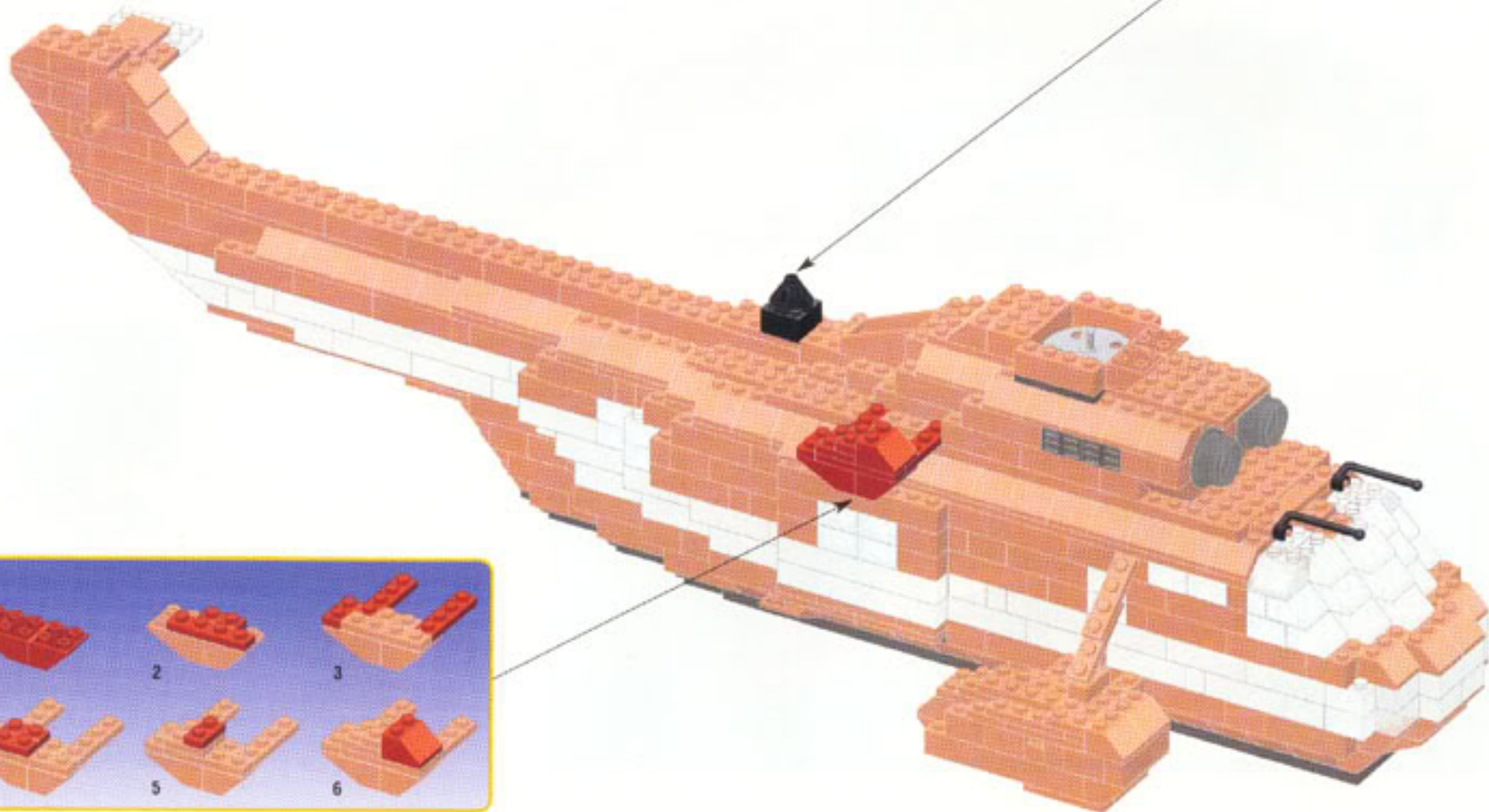

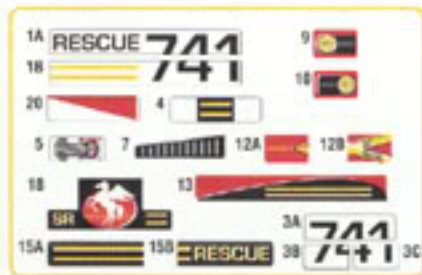
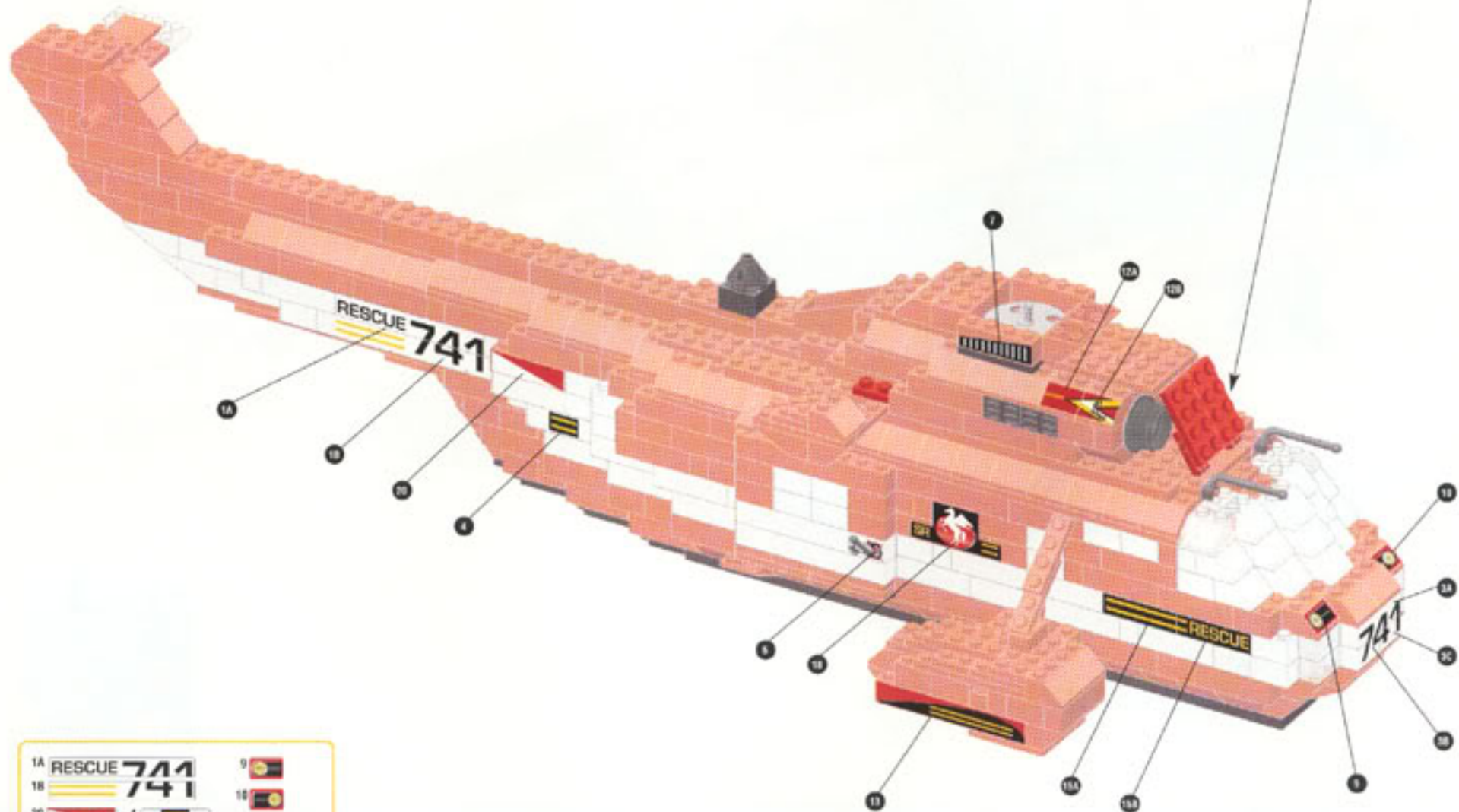



Active step / Étape active / Etapa activa / Istruzione attuale
Aktiv skede / Folgende stap / 次なるステップ / 前段階

Previous step / Étape précédente / Etapa precedente / Istruzione precedente
Føregående skede / Yorige stap / 前のステップ / 前段階



47

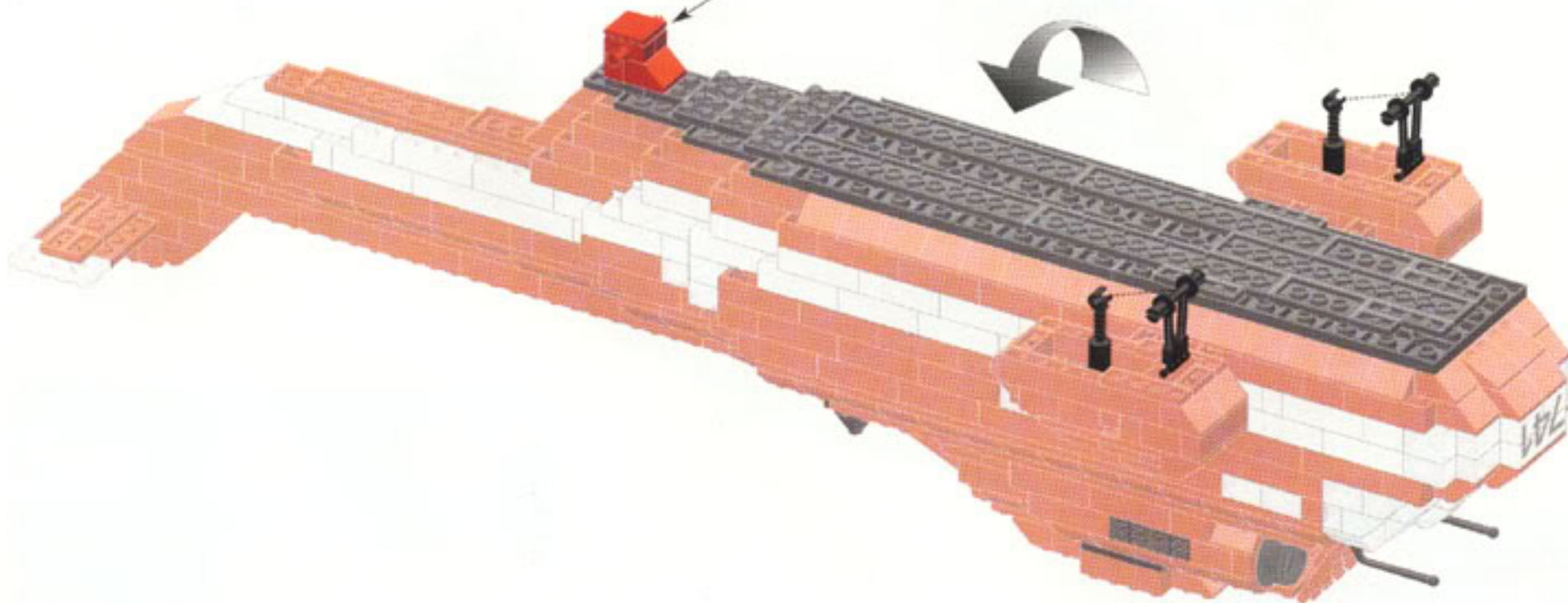
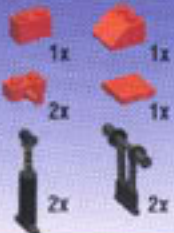

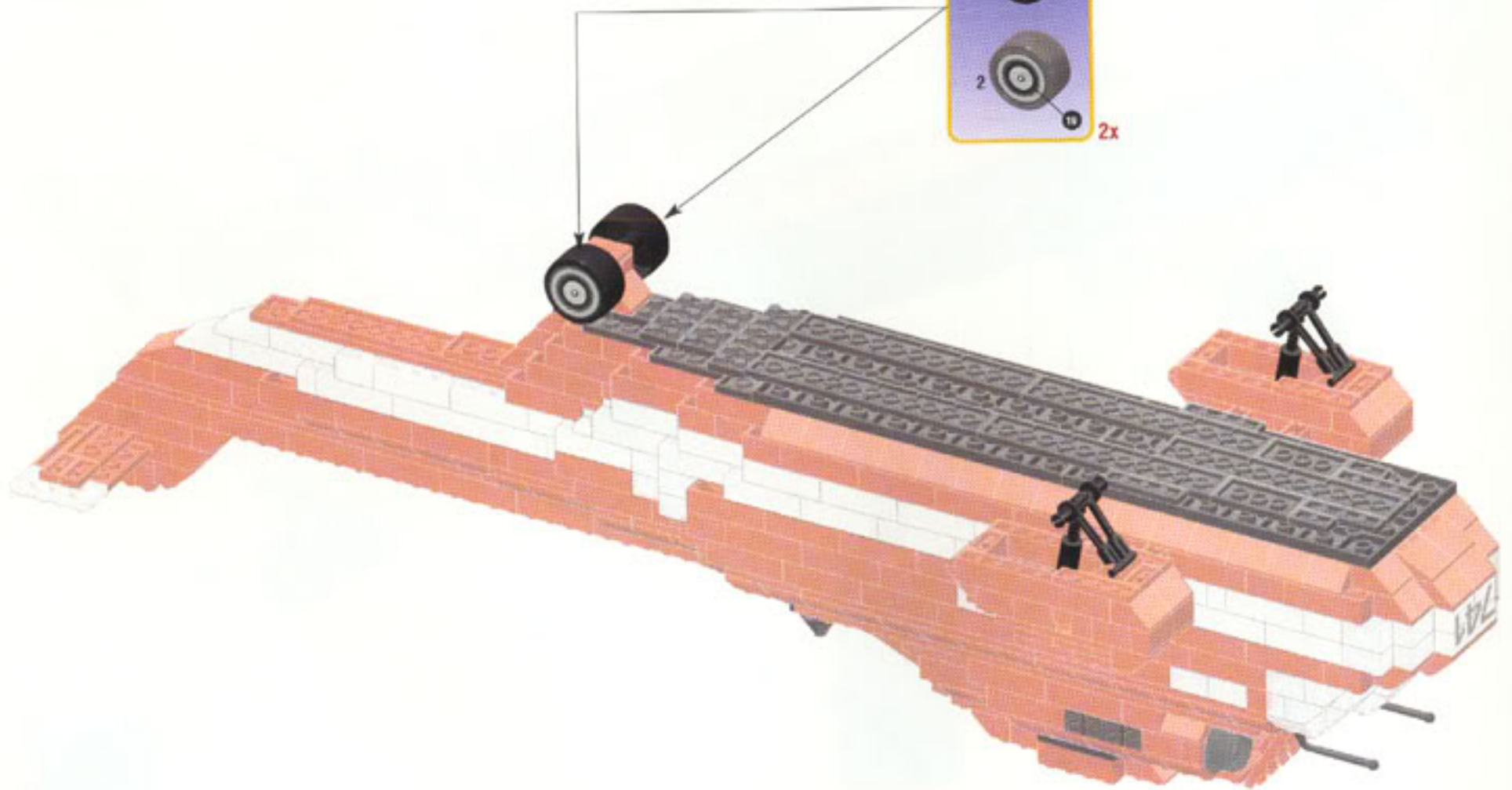



Active step / Étape active / Etapa activa / Istruzione attuale
Aktiv skede / Folgende stap / 活 動 步 驟 / 現 在 步 驟

Previous step / Étape précédente / Etapa precedente / Istruzione precedente
Föregående skede / Vorige stap / 前 一 步 驟 / 前 一 步 驟

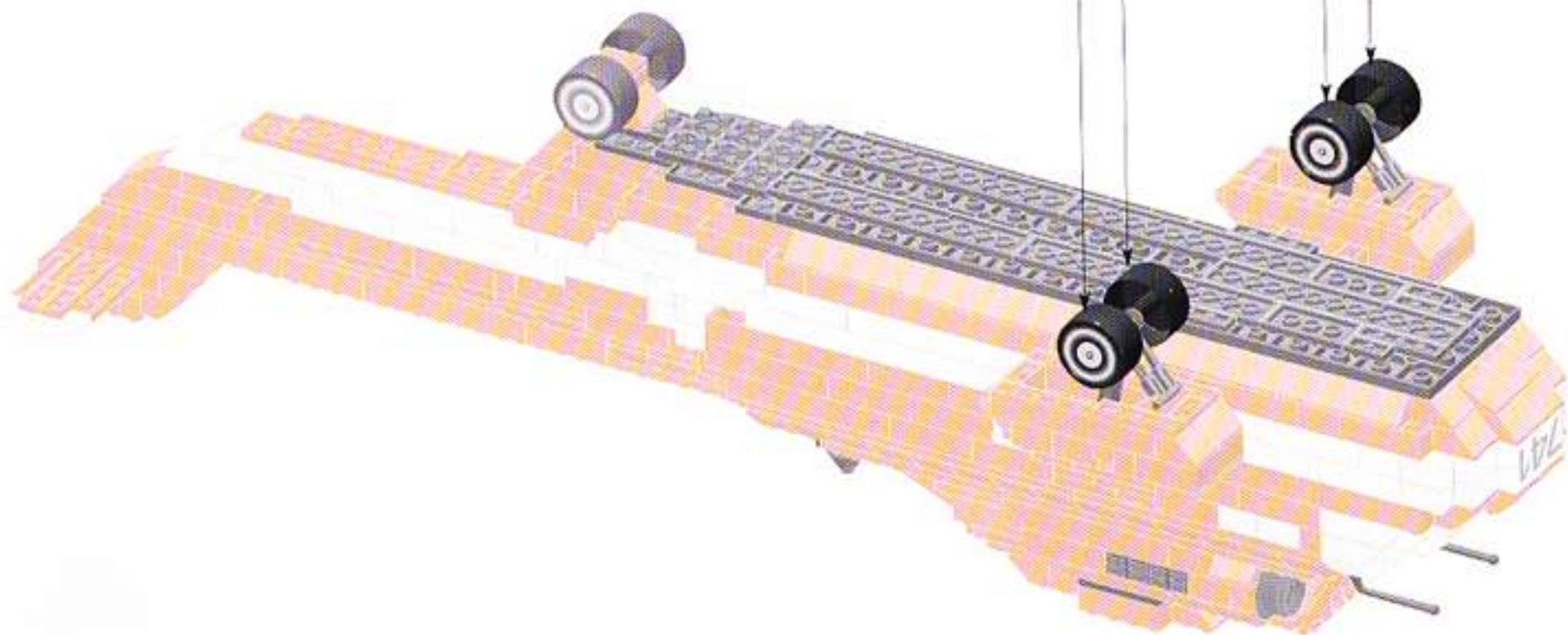

50

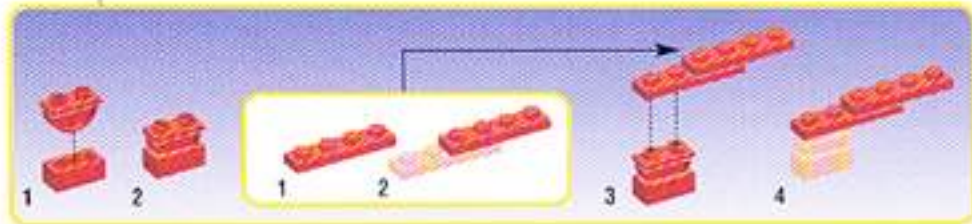
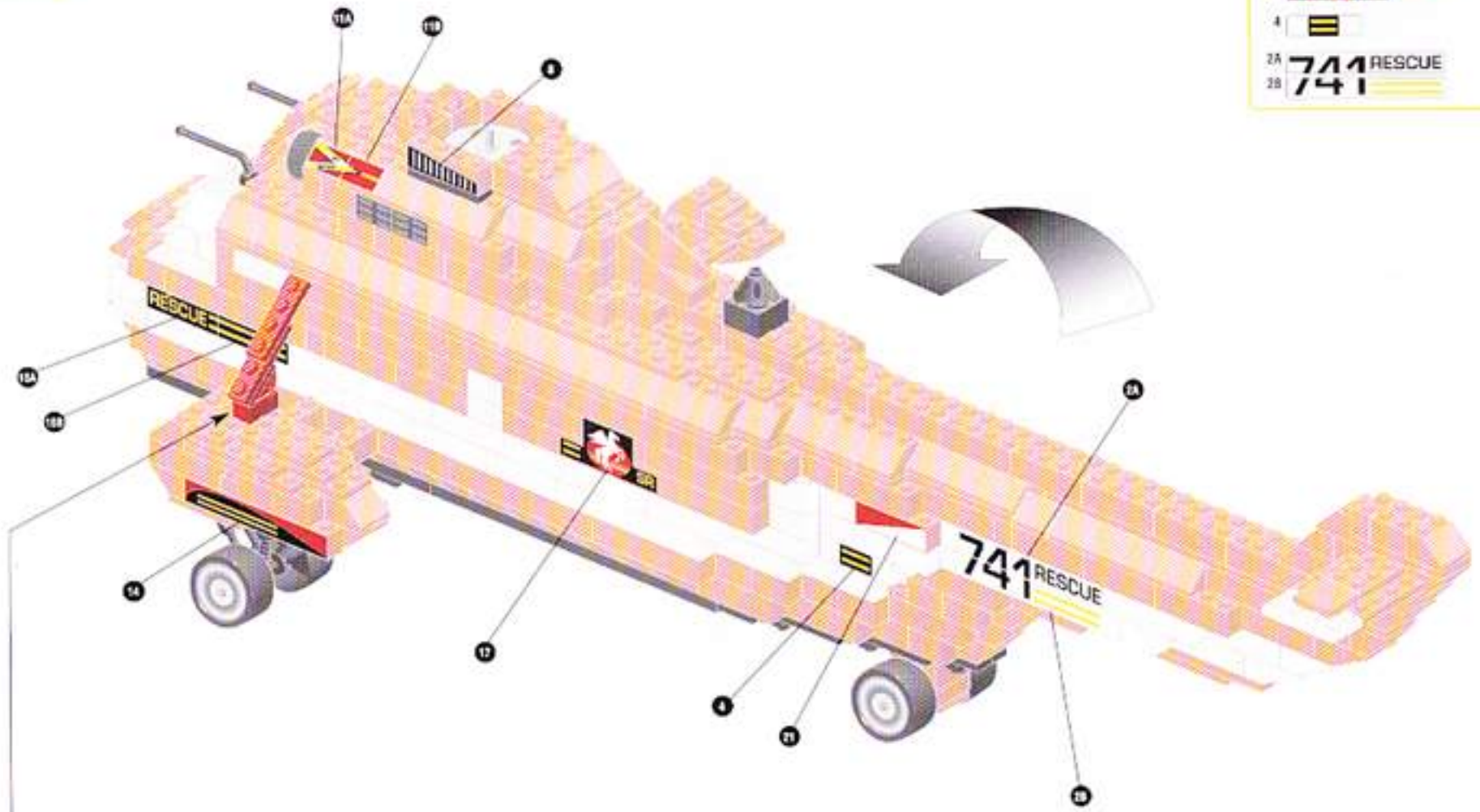



Active step / Étape active / Etapa activa / Istruzione attuale
 Aktiv skede / Folgende stap / 下一个步骤 / 现阶段

Previous step / Étape précédente / Etapa precedente / Istruzione precedente
 Föregående skede / Vorige stap / 前一个步骤 / 前阶段



51

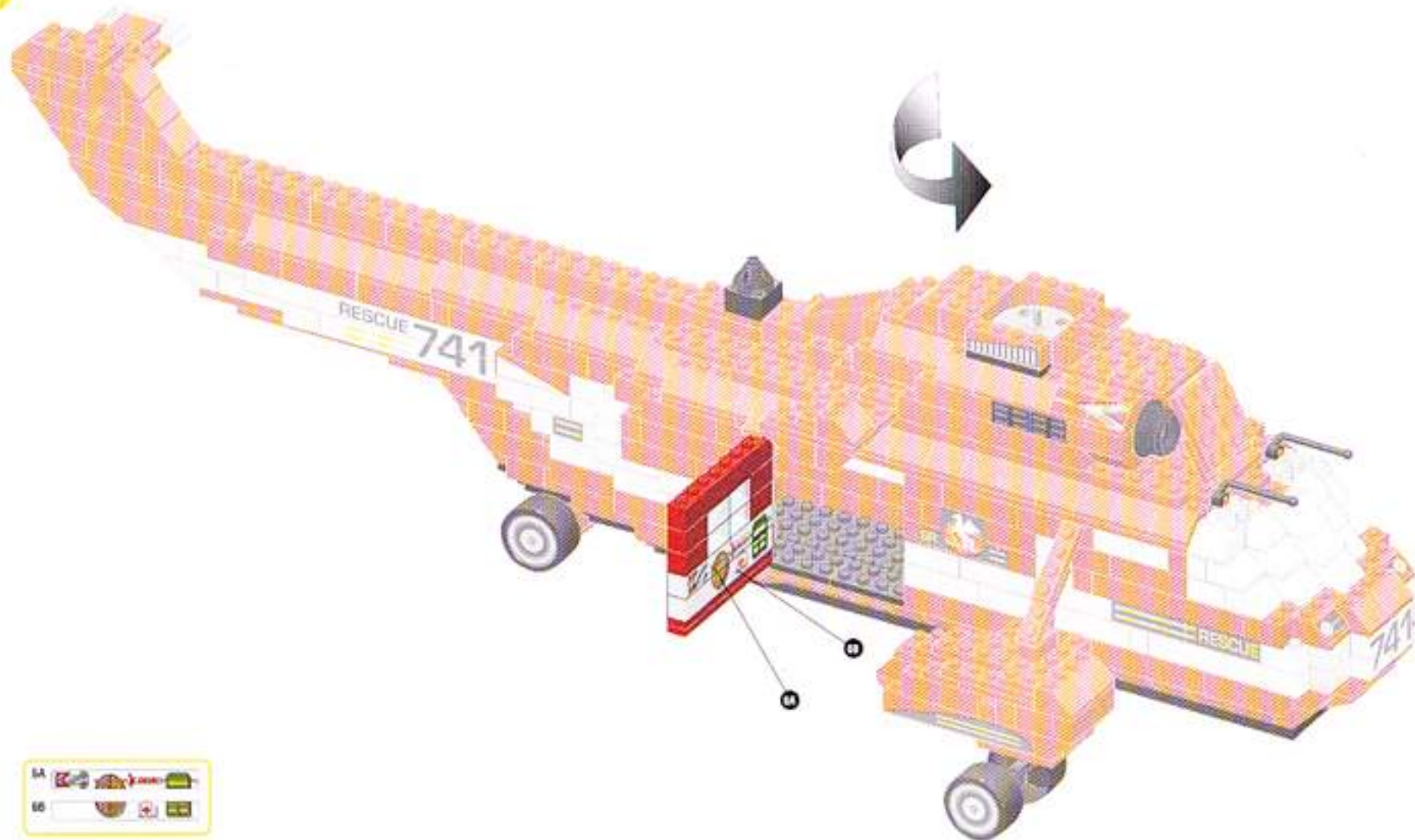

52

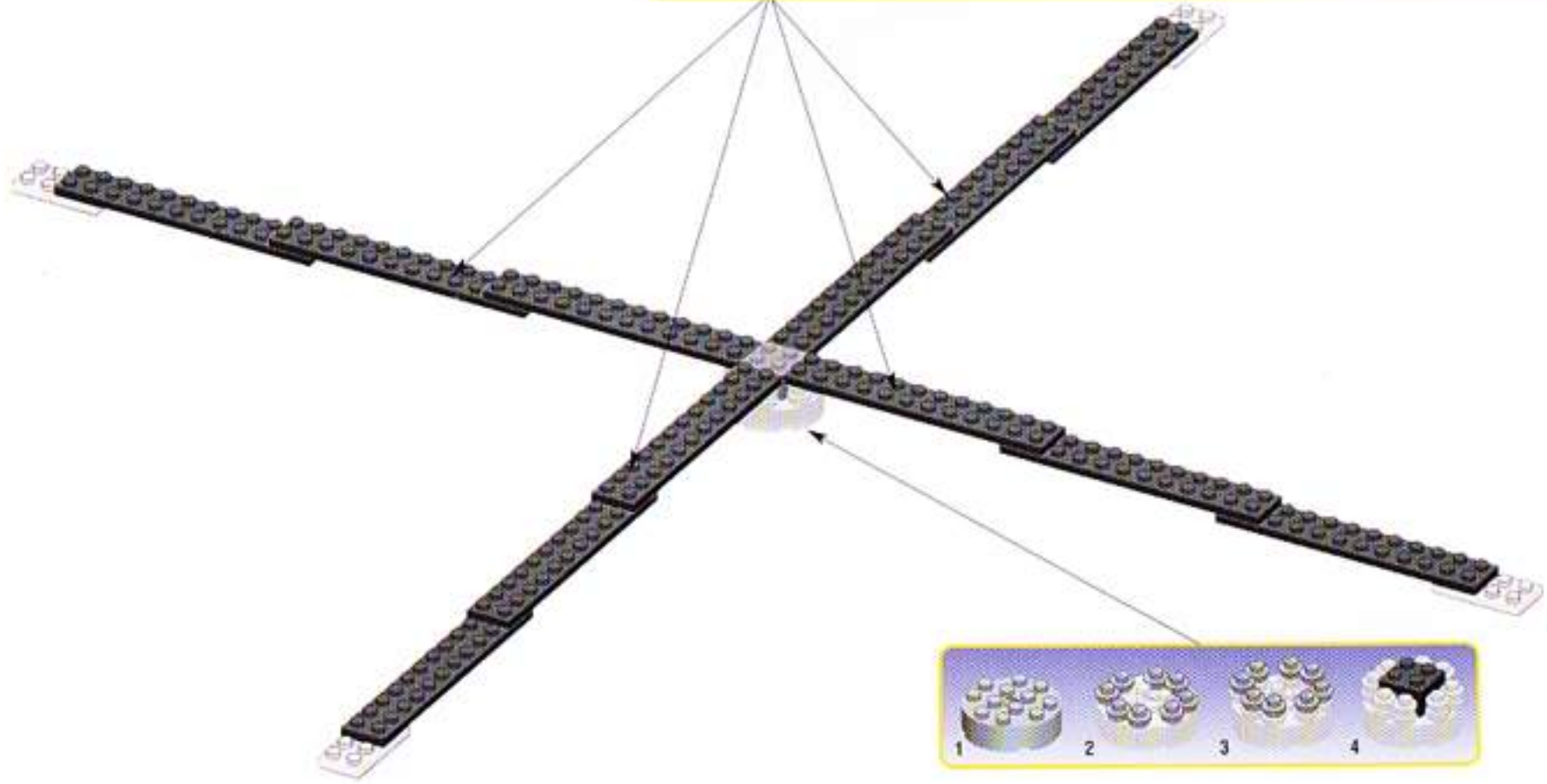
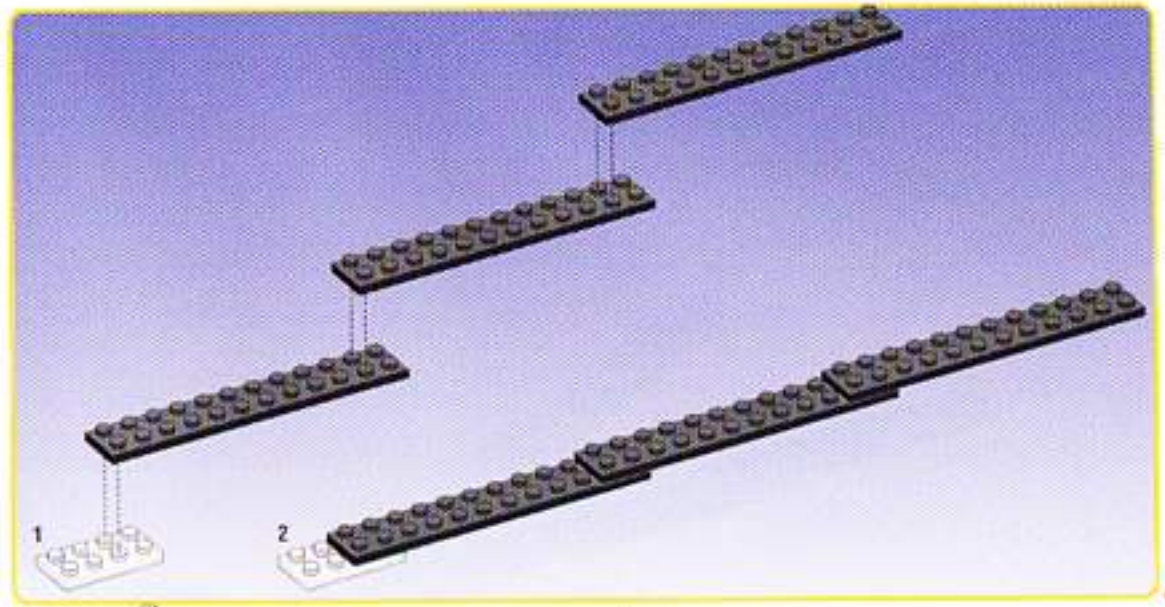



Active step / Étape active / Etapa activa / Istruzione attuale
Aktiv skede / Folgende stap / Aktiv skede / Folgende stap

Previous step / Étape précédente / Etapa precedente / Istruzione precedente
Föregående skede / Vorige stap / Föregående skede / Vorige stap



53



2x

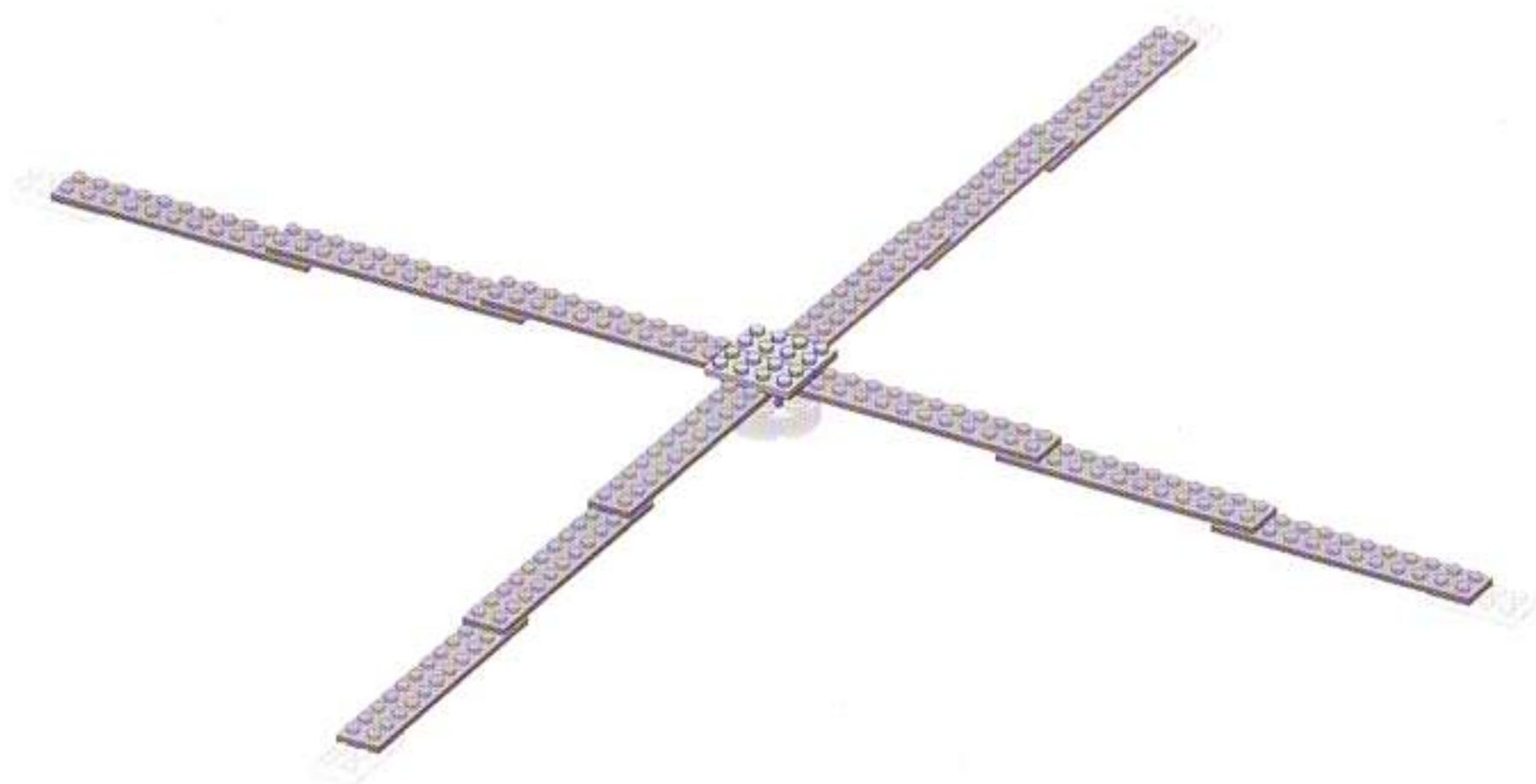

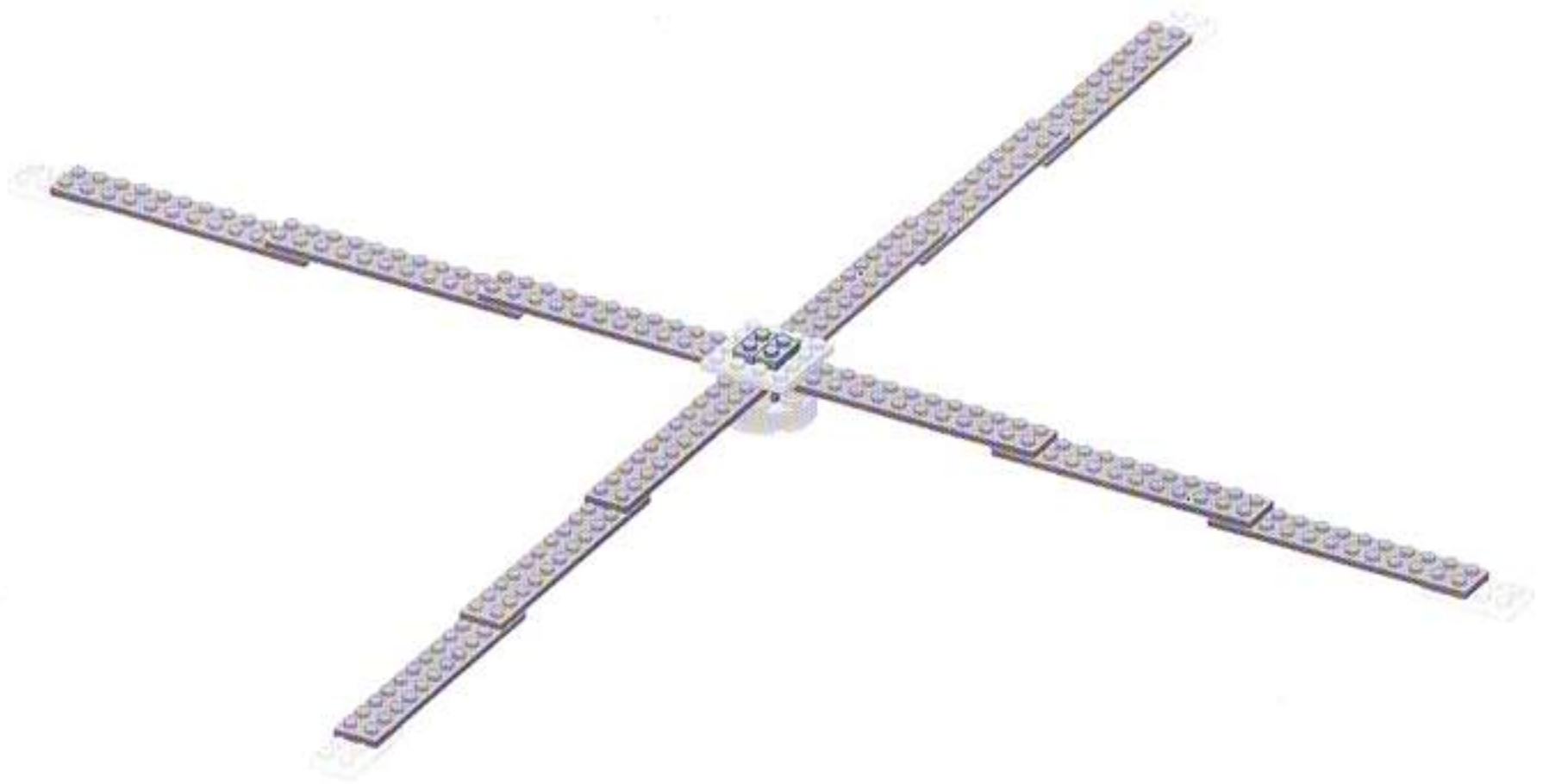



Active step / Étape active / Etapa activa / Istruzione attuale
Aktiv skede / Folgende stap / 此步为步骤 / 此段为

Previous step / Étape précédente / Etapa precedente / Istruzione precedente
Föregående skede / Vorige stap / 此步为前一步 / 此段为前一段



55

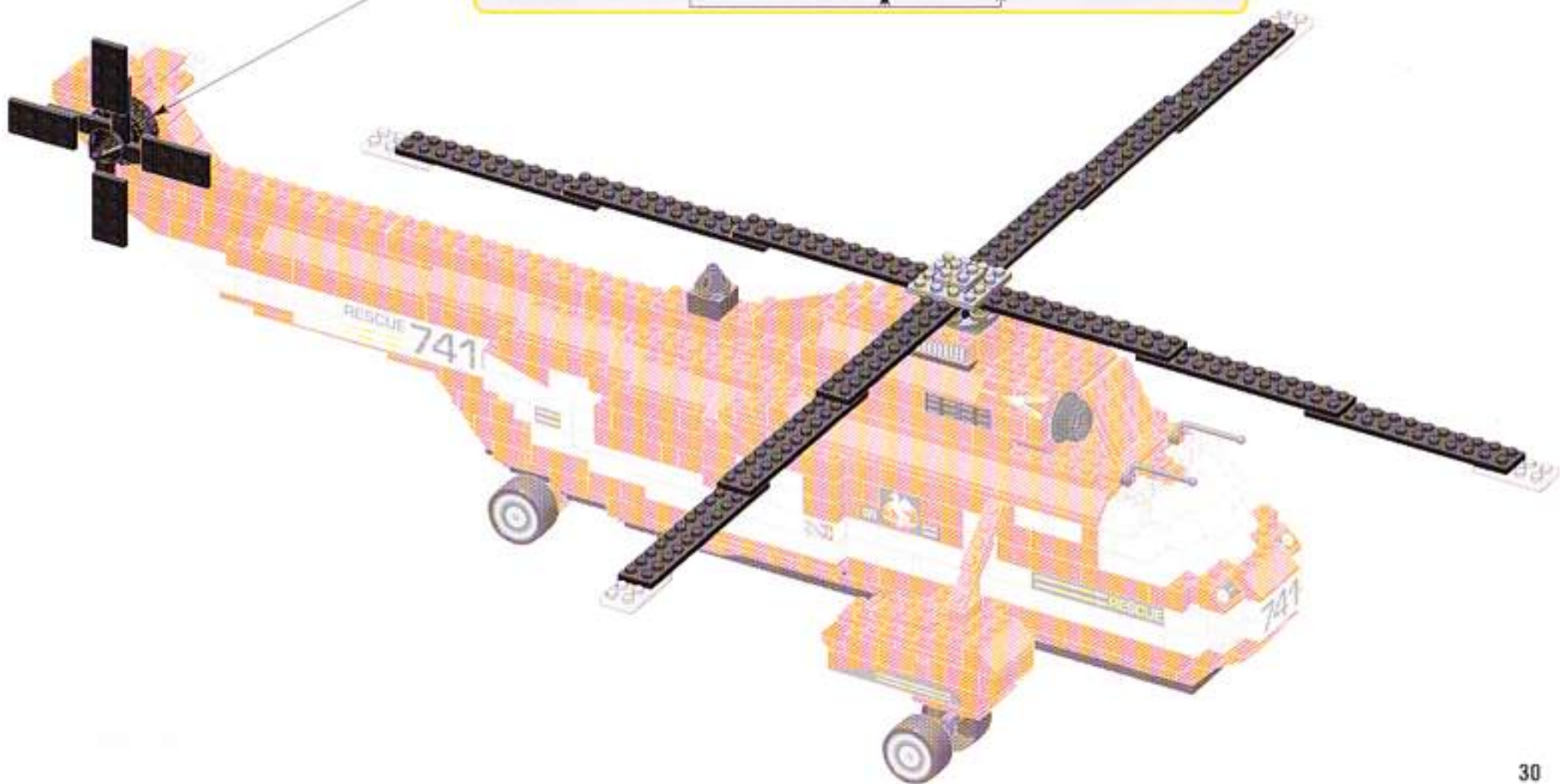





SEA RESCUE

9741



- Items illustrated can be built individually or with added components.
- Les items illustrés peuvent être construits individuellement ou avec des pièces additionnelles.
- Los objetos ilustrados pueden ser contruidos individualmente o con piezas adicionales.



Ritvik

© 2000, RITVIK HOLDINGS INC.
PRINTED IN CANADA D97041

INTERNET: WWW.MEGABLOKS.COM