

**MEGA
BLOKS**

PROBUILDER

MASTER SERIES

9795

**USS
Nimitz**

10+

































































































































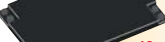





















Ages/Edades
Åges/Leeftijden

1400

Pieces/Piezas
Pièces/Onderdelen



8 fighter jets / 8 cazas a reacción / 8 chasseurs à réaction / 8 straaljagers

 3x M1113A	 2x AM01683JN	 2x M09013JN	 4x AM04248D	 2x M1314F	 3x M1087F	 1x AM03873JG	 4x AM04249D0
 1x M1113ZD	 2x M1137JG	 4x M09013F	 8x AM04247D0	 14x M1314D0	 24x M1087D0	 6x AM03873D0	 1x AM02237F
 2x M1113X	 2x M1137JN	 66x M09013D0	 4x AM04245E	 1x M1314JG	 37x M09493F	 22x AM04244D0	 1x AM02237F
 3x M1113JB	 2x M1137JN	 4x AM02799D0	 4x M10271D0	 4x M1416D0	 68x M09493D0	 34x AM02308F	 2x M1128D0
 2x M1113D0	 2x M1147JN	 8x M11101D0	 73x M1154D0	 1x M1418F	 8x M09493A	 2x AM03768D0	 2x AM04246F
 1x M1113JN	 2x M1147JN	 29x M1417D0	 2x M1390F	 2x AM03063N	 2x M1313F	 2x AM03768D0	 2x AM04246F
 1x M0910F	 3x AM02049JG	 1x M1322D0	 12x AM03772D0	 1x M1123JG	 1x M1313JG	 2x AM03768D0	 2x AM04246F
 2x M0910E	 1x AM02042JG	 3x AM03773D0	 4x AM03772F	 10x M09593F	 14x M1313D0	 2x AM03768D0	 2x AM04246F
 3x M0910JG	 1x M1086F	 1x AM03773JG	 2x AM03772JG	 2x M09593JG	 1x M1023F	 1x AM03768F	 1x AM02100N
 1x AM02172F	 5x M1086F	 2x AM02215JG	 1x M142D0	 41x M0959D0	 26x M10233D0	 1x AM03768F	 9x AM01530F
 3x M1225F	 22x M1108D0	 1x M1404D0	 3x M1139F	 7x AM01847JG	 2x M1480A	 3x AM1326F	 9x AM01530F
 1x M1255D0	 15x M022501D0	 2x AM02213JG	 42x M1139D0	 1x M09833JG	 2x M1480A	 1x AM1325F	 4x AM01530D0
 2x M1140D0	 4x M022501JN	 2x AM02213JG	 72x M0948F	 32x M09033A	 23x M1480D0	 1x AM1325F	 4x AM01530D0
 2x M1140JN	 45x M022501F	 2x AM02212D0	 5x M0948JG	 7x AM01847JG	 3x M1480F	 8x AM03015JG	 4x AM01530D0
 12x AM03328D0	 7x M09593F	 22x M09023D0	 3x M0948D0	 1x M09033JG	 1x M1480JG	 4x AM03015D0	 12x M1324F
 32x AM03328F	 1x M09393JG	 1x M09023JG	 5x AS0979505	 15x M09033JN	 2x M1172D0	 1x AM03015D0	 8x AS0979501
 3x AM02050JG	 54x M09393D0	 1x M09023JN	 2x AS0979503	 270x M09033D0	 1x M1172JN	 1x AM03770F	 8x AS0979501
 2x AS0979504	 2x AM03880N	 3x M09023F	 2x M1389F	 11x M09033F	 1x M1172JN	 1x AM02237D0	 1x AS0979502
 8x M1205F	 5x AM03325JG			 2x AM01555D0	 12x M1172F		 1x AS0979502
 1x S1124D0							 1x AS0979502



9795



Color chart.
Cuadro cromático.

Charte de couleurs.
Färgtabell.

Kleurenkaart.
Quadro cromático.

カラーチャート
色彩表



Active step / Etapa activa / Étape active / Aktivt skede
Active step / Etapa activa / Étape active / Aktivt skede
Active step / Etapa activa / Étape active / Aktivt skede
Active step / Etapa activa / Étape active / Aktivt skede

Please read these instructions carefully before first use and keep them for future reference.
Leer estas instrucciones cuidadosamente antes de la primera utilización y guardarlas para referencia futura.
Il est recommandé de lire attentivement ce feuillet avant la première utilisation et de le conserver pour référence future.
Wij raden u aan deze handleiding zorgvuldig te lezen en te bewaren voor eventuele raadpleging op een later tijdstip.

- ⚠️ **WARNING:**
CHOKING HAZARD. - Small parts.
Not for children under 3 years.
- ⚠️ **ADVERTENCIA:**
PELIGRO DE ASFIXIA. - Contiene piezas pequeñas.
No recomendado para niños menores de 3 años.
- ⚠️ **AVERTISSEMENT:**
RISQUE DE SUFFOCATION. - Présence de petits éléments.
Ne convient pas aux enfants de moins de 3 ans.
- ⚠️ **VAROITUS:**
HUUMOSVAARA. - Sisältää pieniä osia.
Ei alle 3-vuotiaa lapsille.
- ⚠️ **ATTENZIONE:**
PERICOLO DI SOFFOCAMENTO. - Contiene piccole parti.
Non indicato per bambini sotto i 3 anni.
- ⚠️ **WARNING:**
ERSTYKINGSFAHR. - Enthält kleine Teile.
Nicht für Kinder unter 3 Jahren geeignet.
- ⚠️ **ADVARSEL:**
KVELINGSFARE. - Fendeholter smådele.
Bare for barn under 3 år.
- ⚠️ **PERILOONOHJE:**
KIVÄNKÖN VAARAT. - Pieniä osia.
Ei alle 3-vuotiaa lapsia.
- ⚠️ **VAROITUS:**
TUKEHTUMISVAARA. - Sisältää pieniä osia.
Ei alle 3-vuotiaa lapsille.
- ⚠️ **ATTENZIONE:**
PERICOLO DI SOFFOCAMENTO. - Contiene piccole parti.
Non indicato per bambini sotto i 3 anni.
- ⚠️ **ADVARSEL:**
KVELINGSFARE. - Innholder små deler.
Kan for barn over 3 år.
- ⚠️ **ATENÇÃO:**
PERIGO DE ASFIXIA. - Contém peças pequenas.
Não é recomendado para crianças de menos de 3 anos.
- ⚠️ **WARNING!**
KVAEMINGSRISK. - Innihåller små delar.
Bare för barn under 3 år.
- ⚠️ 警告
窒息の危険性 小さな部品が含まれています
3歳以下の子どもには身入らないで下さい。
- ⚠️ 警告
窒息の危険性 小さな部品が含まれています
3歳以下の子どもには身入らないで下さい。



Section 1 • Sección 1
Section 1 • Deel 1



Section 3 • Sección 3
Section 3 • Deel 3

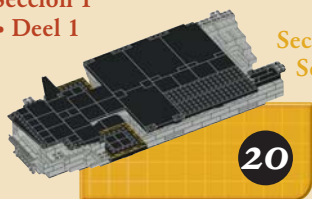

Section 2 • Sección 2
Section 2 • Deel 2

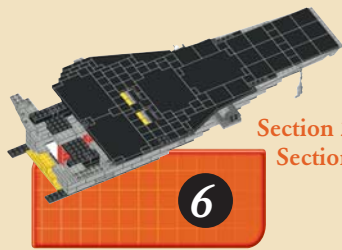

Section 4 • Sección 4
Section 4 • Deel 4

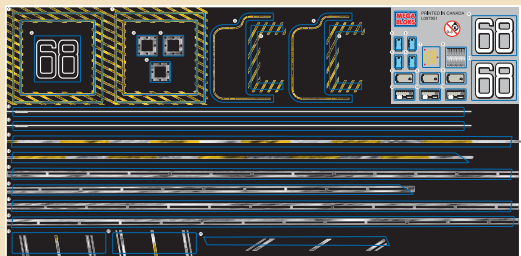

Apply stickers
Aplicar autocollantes
Sopporer les autocollants
Sickers aanbrengen



1x
L097951



Section 1 • Sección 1
Section 1 • Deel 1

- 1 1x 1x



- 2 1x 1x 1x 1x



- 3 1x 1x



- 4 1x 2x 1x 1x 1x 1x



- 5 2x 3x 1x



- 6 1x 1x



- 7 2x 1x 1x



- 8 1x 4x 1x 1x

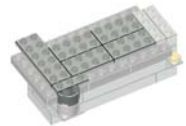

- 9 3x 1x 2x

- 1 2



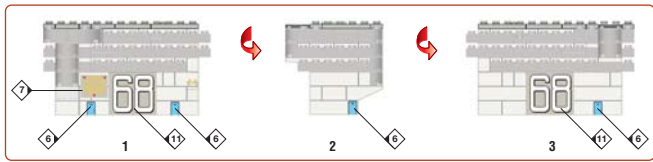
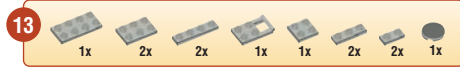
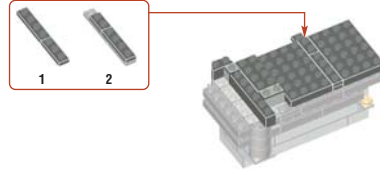

Section 2 • Sección 2
Section 2 • Deel 2

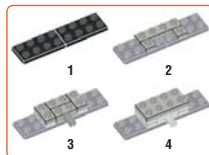
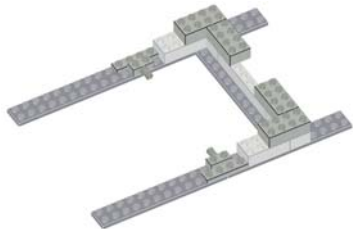
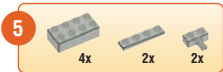
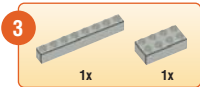
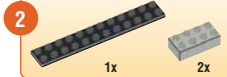
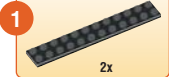

2x

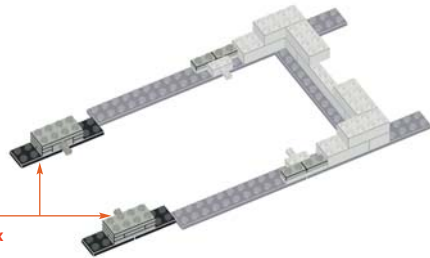

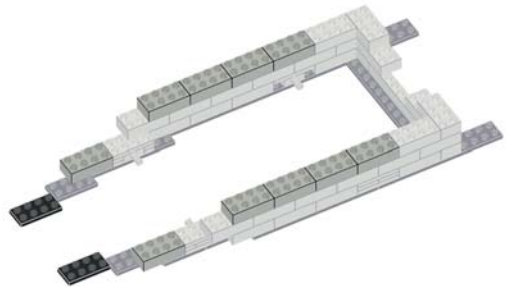
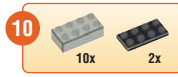
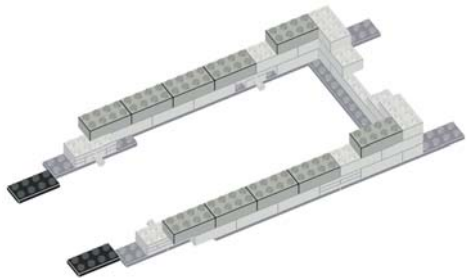
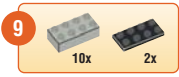
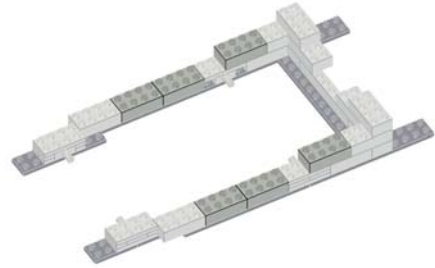
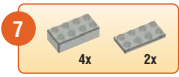

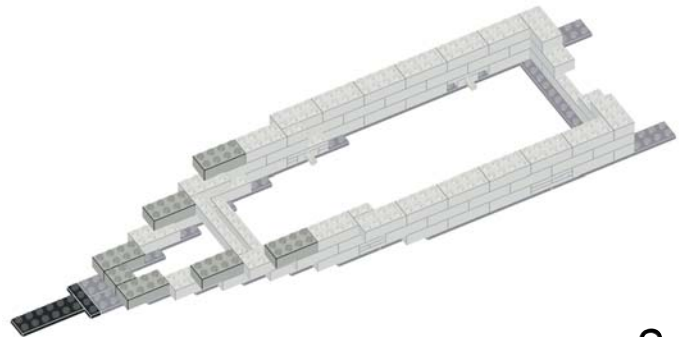
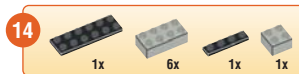
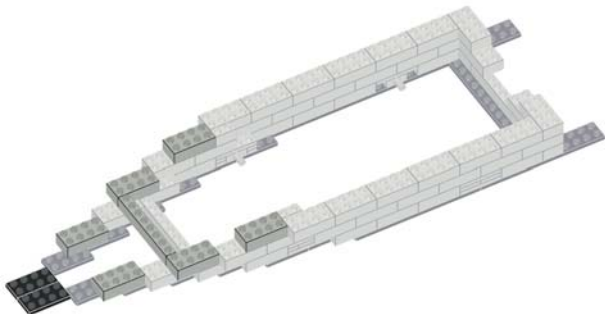
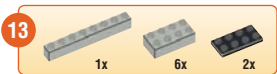
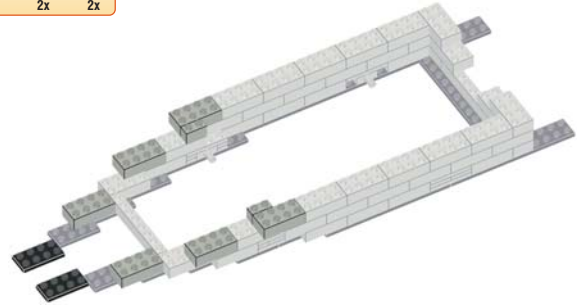
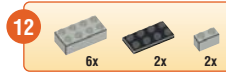
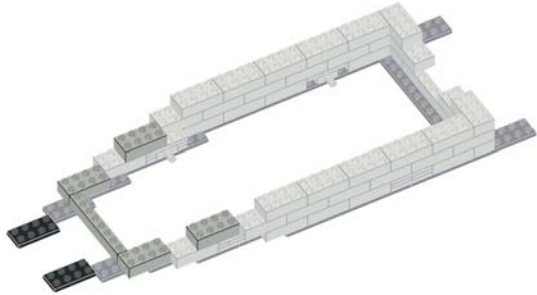
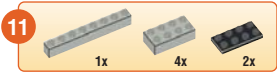

15

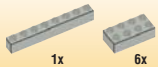

16



17

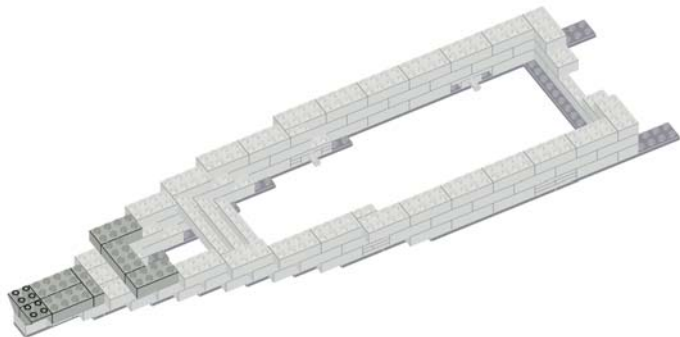
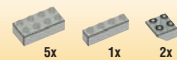

18

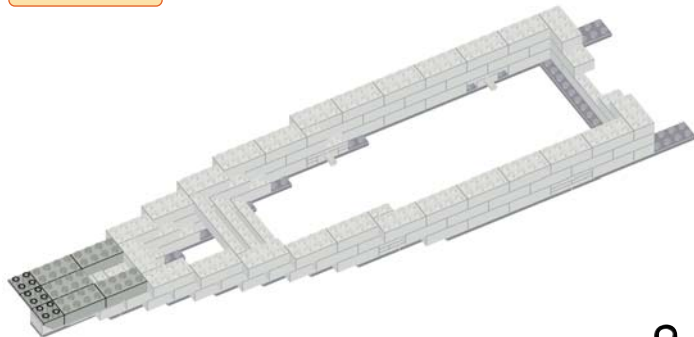

19

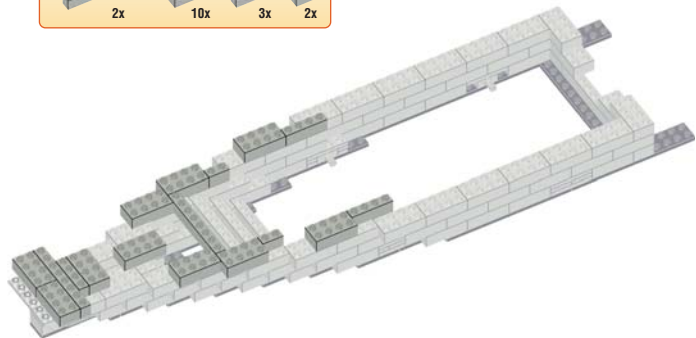

20

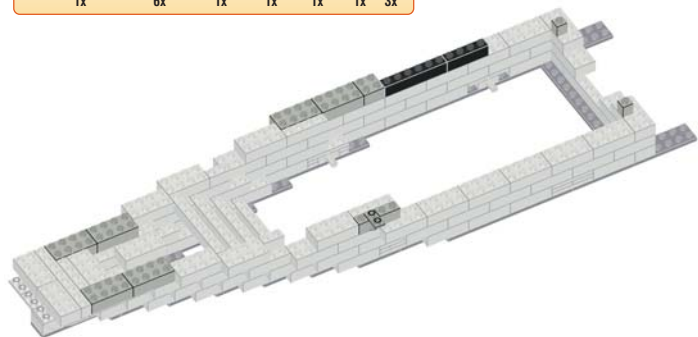

21

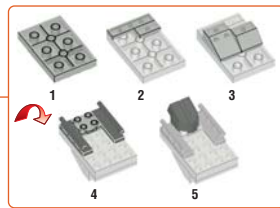
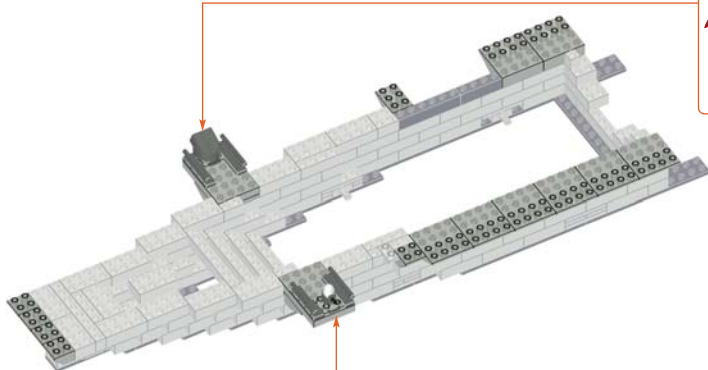
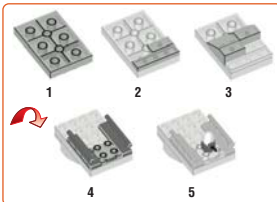

22

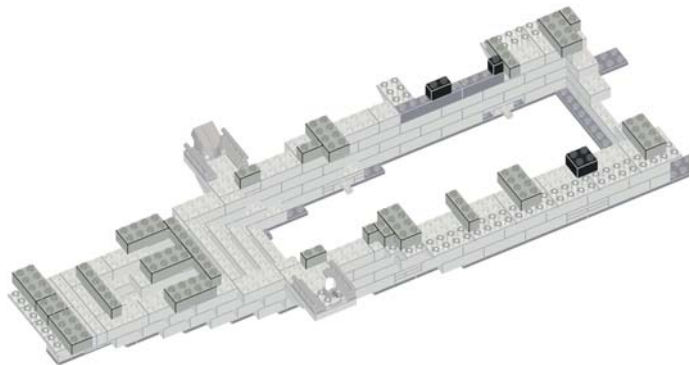

23

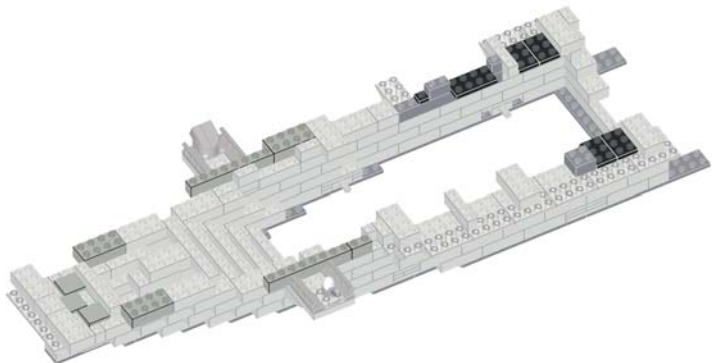

24

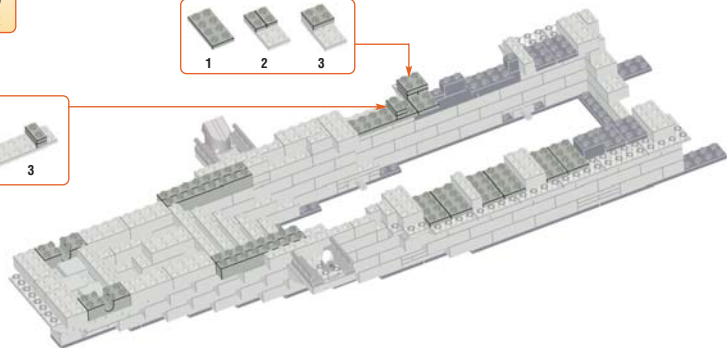
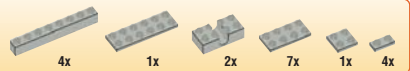

25

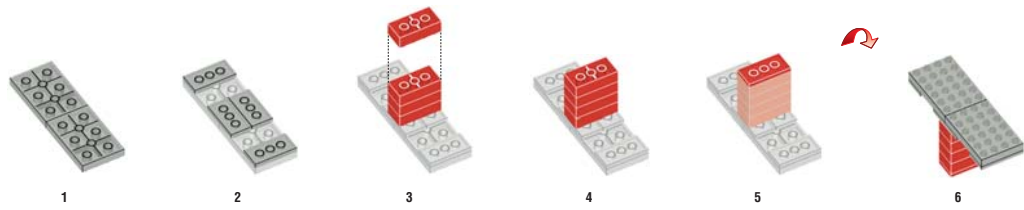
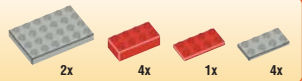

26

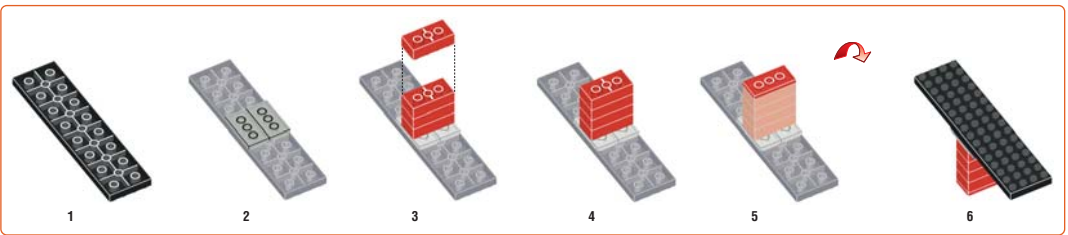
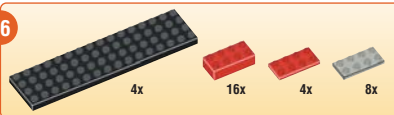

4x

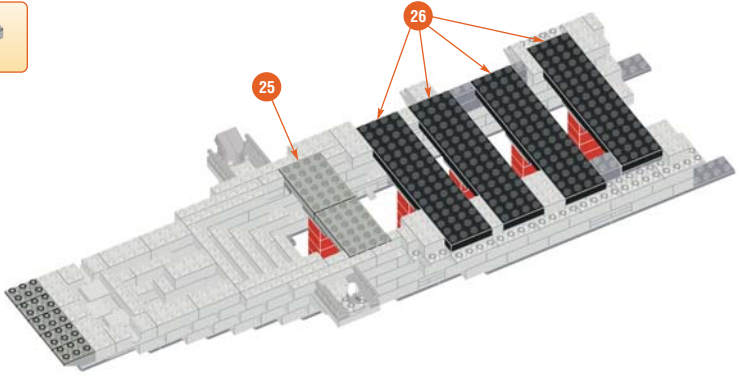

Adult assistance may be required.
 Puede ser necesaria la ayuda de un adulto.
 L'assistance d'un adulte peut être requise.
 De hulp van een volwassene kan nodig zijn.

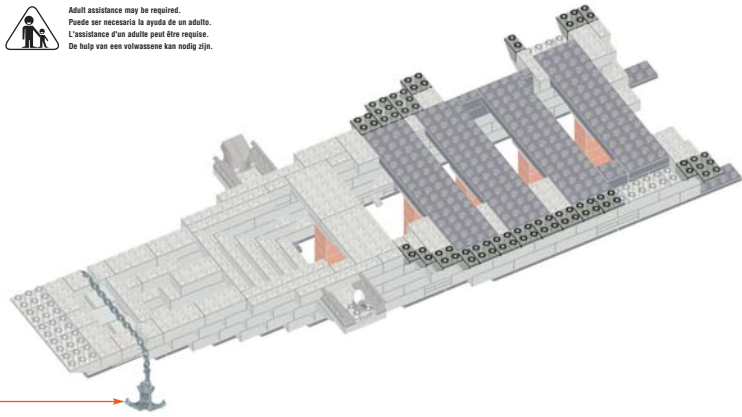
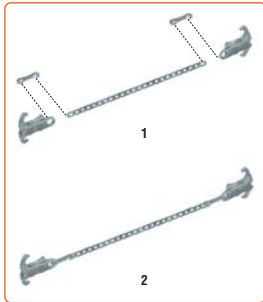

29

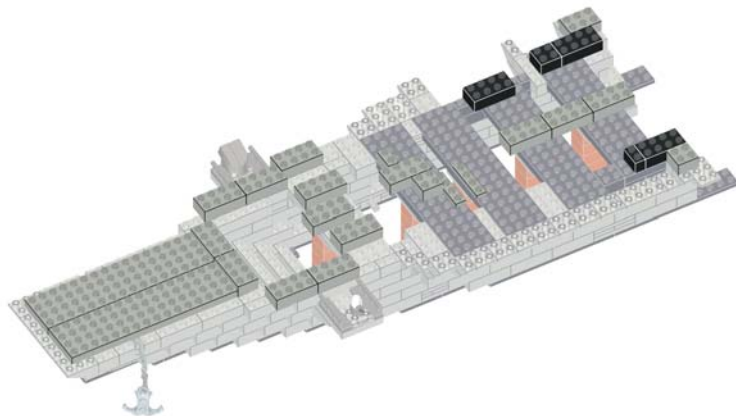
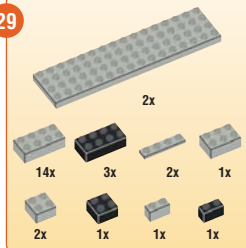

30

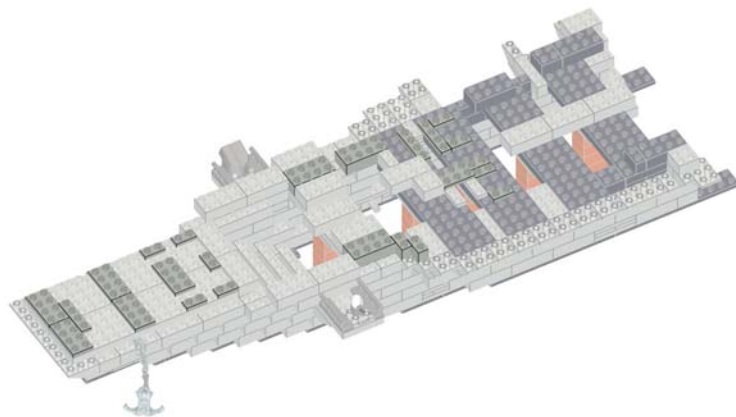
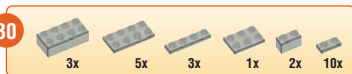

31

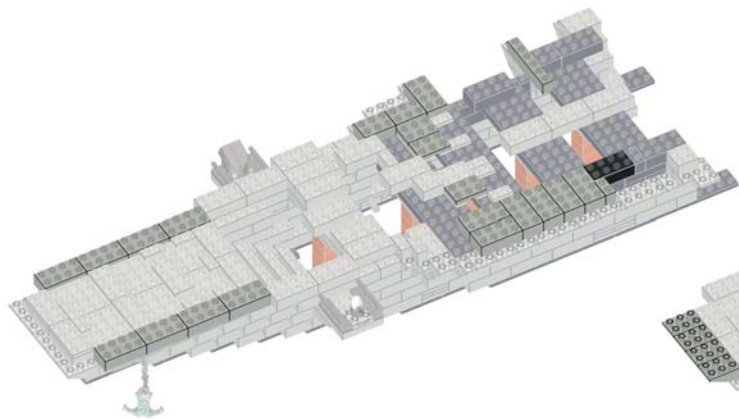

32

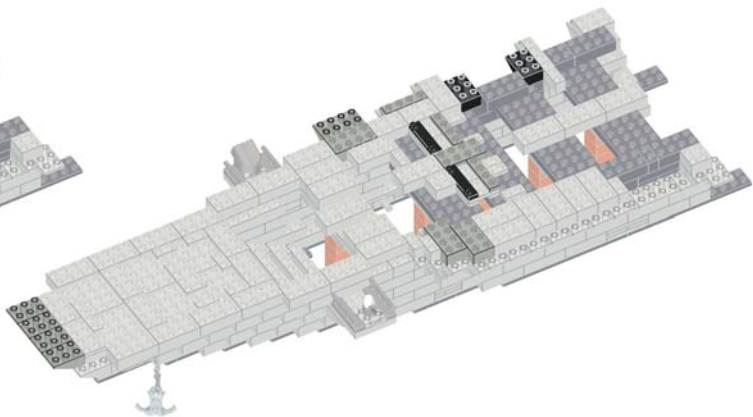

33

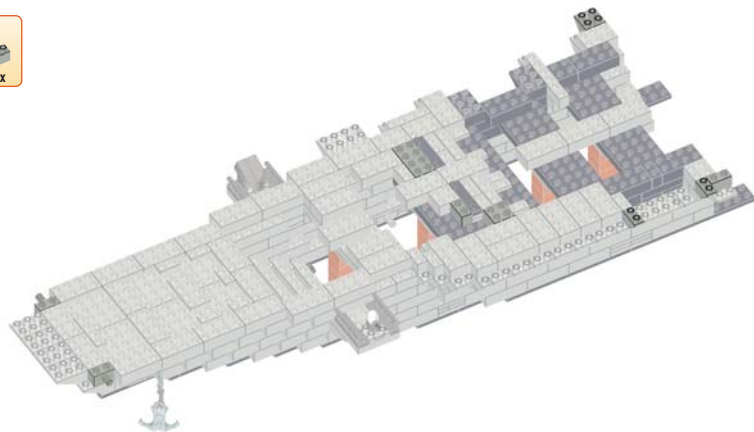

34

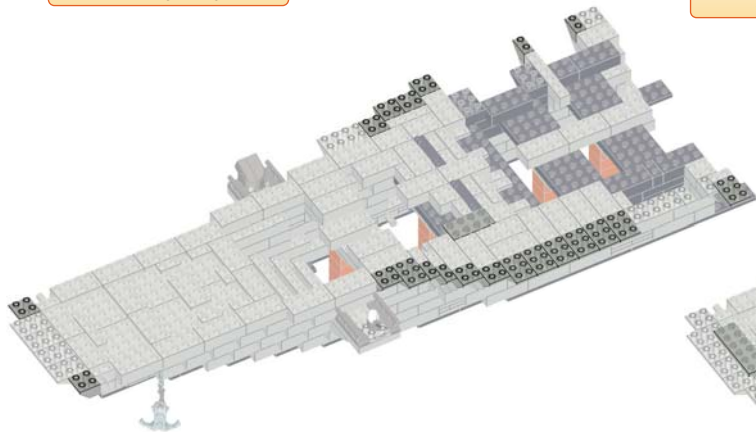

35

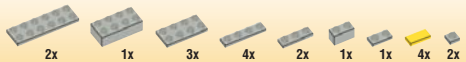

36

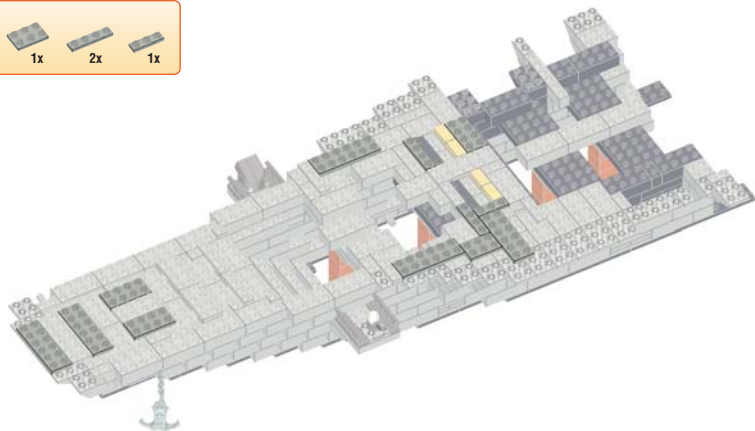

37

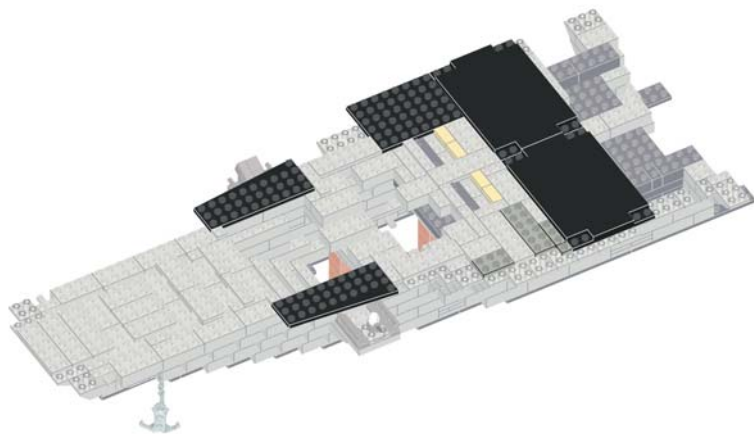

38

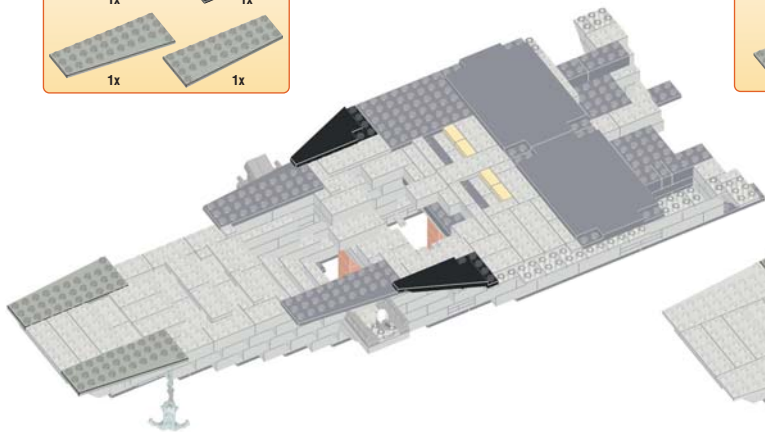
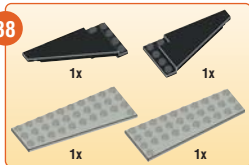

39

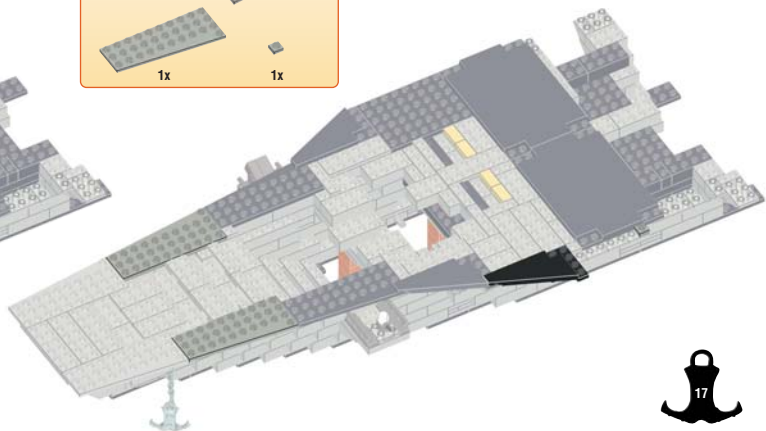
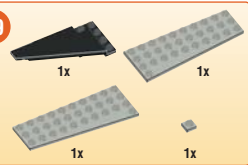

40

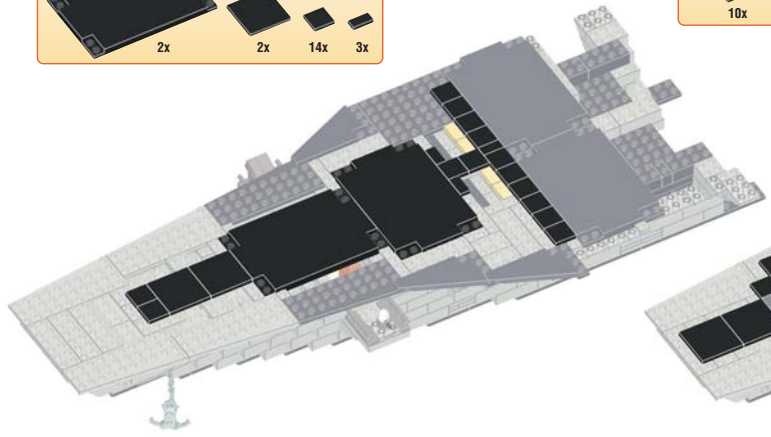
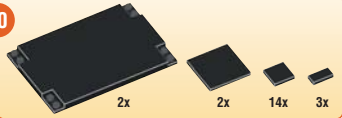

41

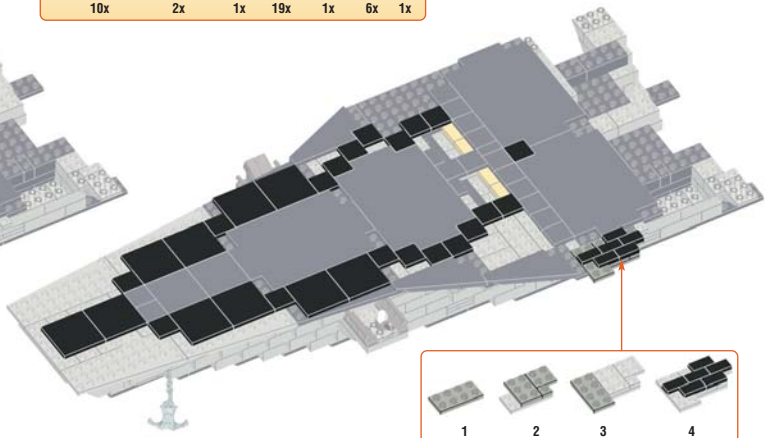
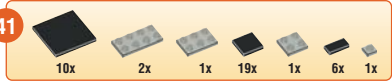

42

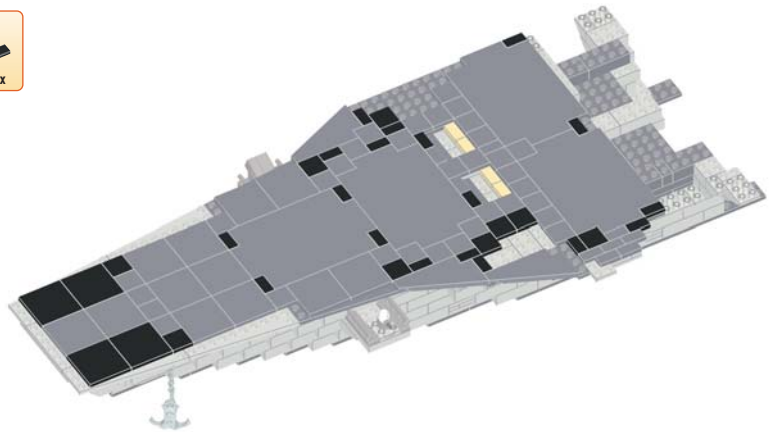

43

8x 2x 8x

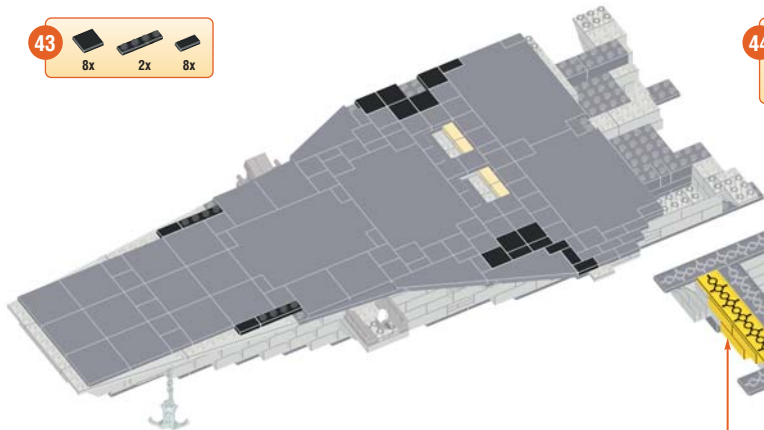

44

1x 3x



45

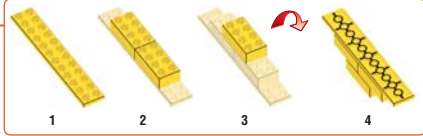
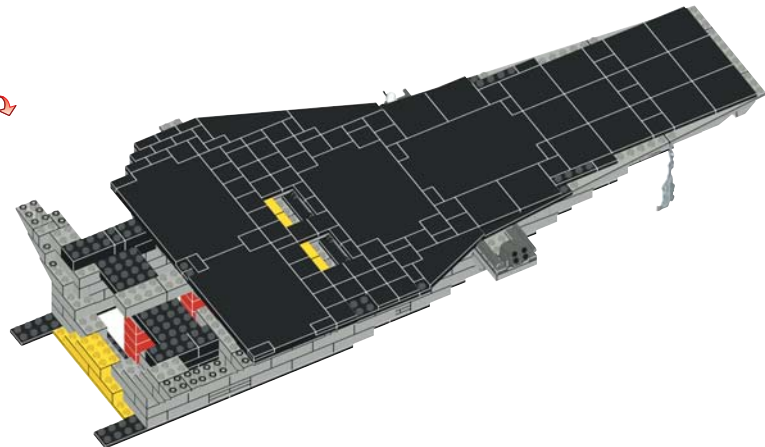

Section 3 • Sección 3
Section 3 • Deel 3



PLACE TEMPORARY PIECE.
COLOCAR LA PIEZA PROVISIONAL.
INSTALLE LA PIÈCE TEMPORAIRE.
PLAATS TIJDELIJK ONDERDEEL.

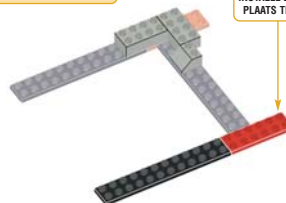

PLACE TEMPORARY PIECE.
COLOCAR LA PIEZA PROVISIONAL.
INSTALLE LA PIÈCE TEMPORAIRE.
PLAATS TIJDELIJK ONDERDEEL.

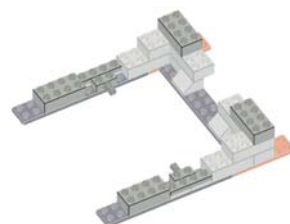
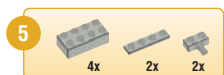
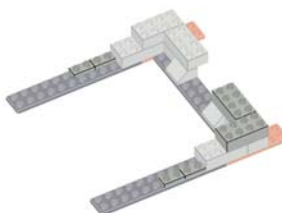
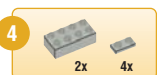

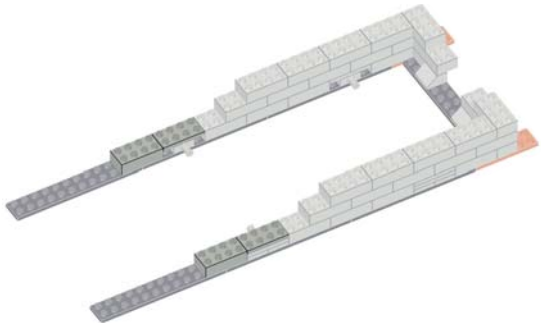
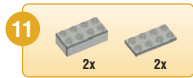
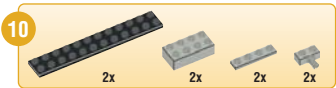
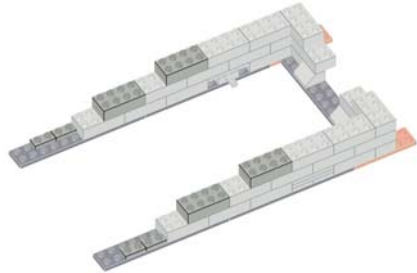
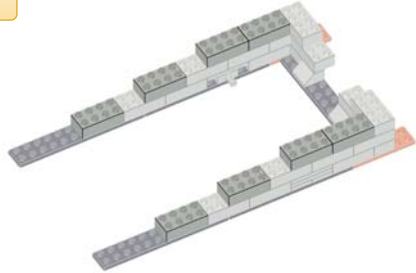

12



4x



13

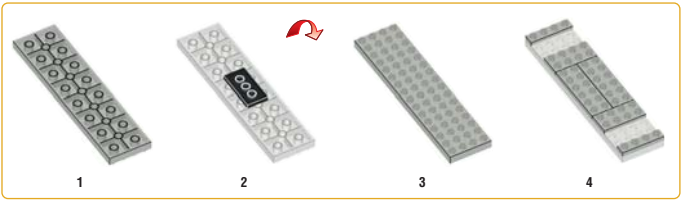
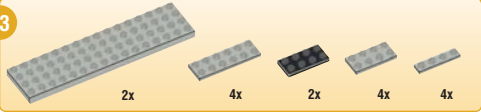

2x

14



4x

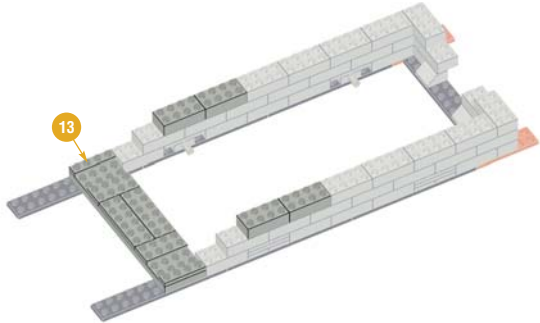

15

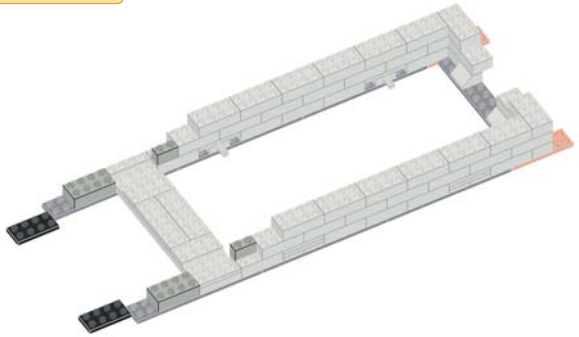

16



2x

2x



17



2x



4x



2x



2x



4x



2x

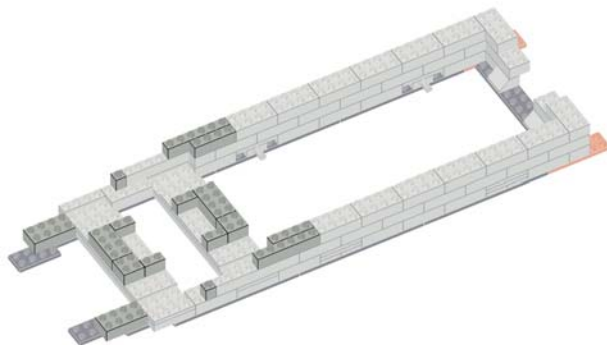

18

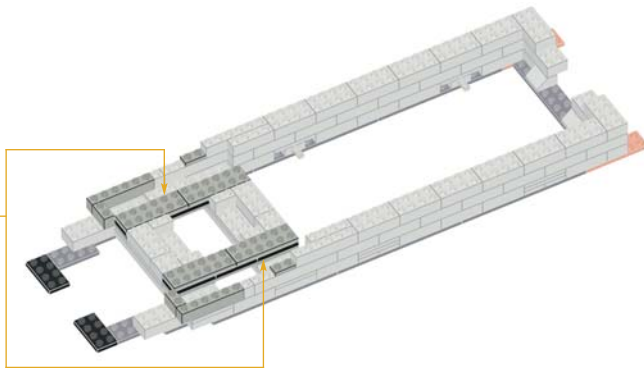
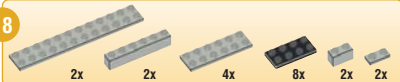

19

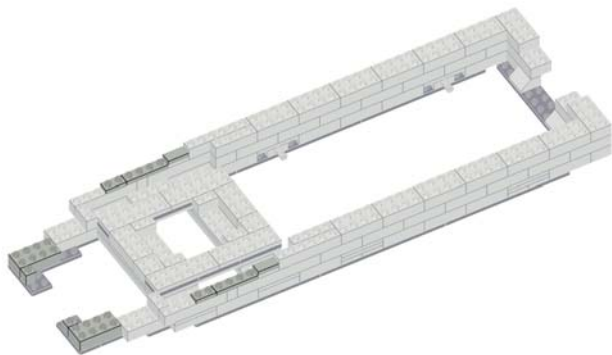

20

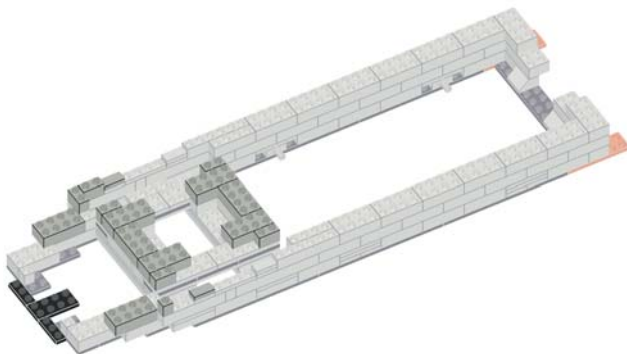

21

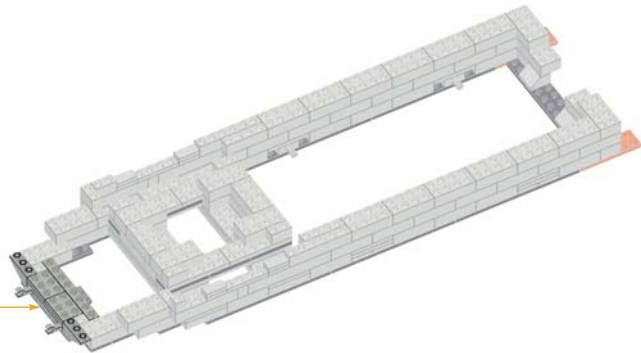
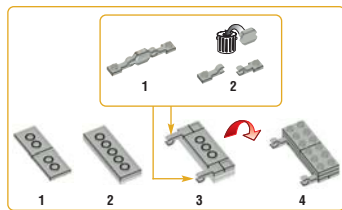
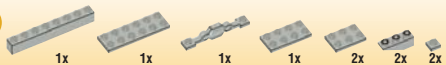

22

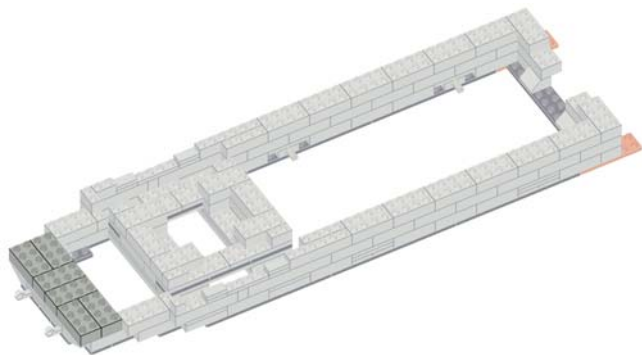

23

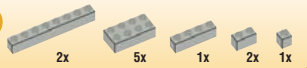

24

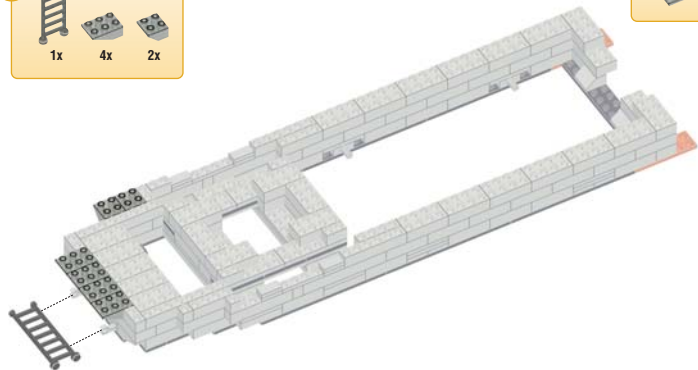
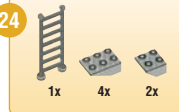

25

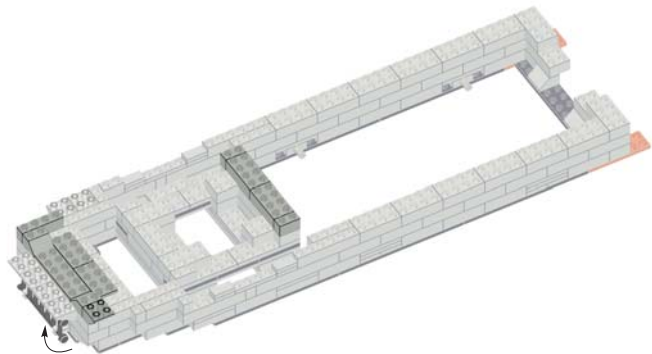

26



27

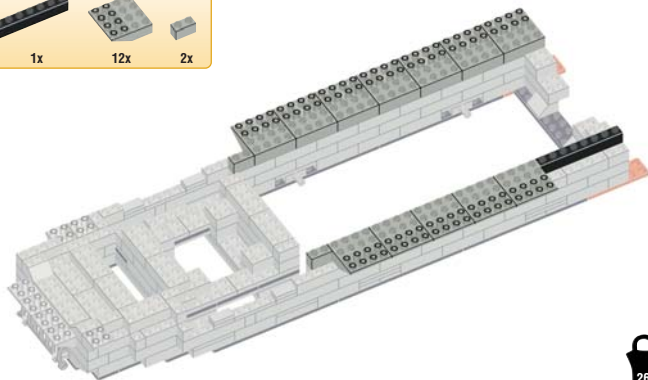
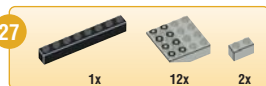

28

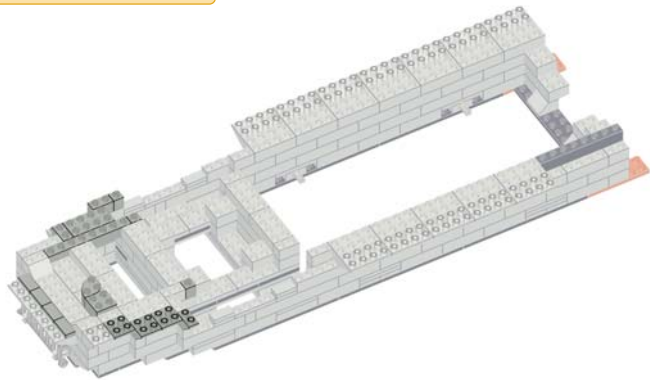

29

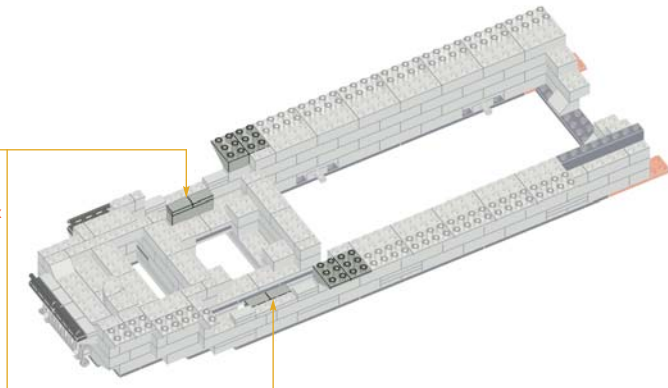

30

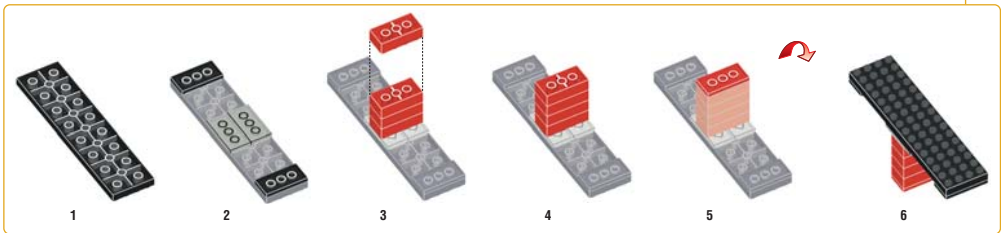
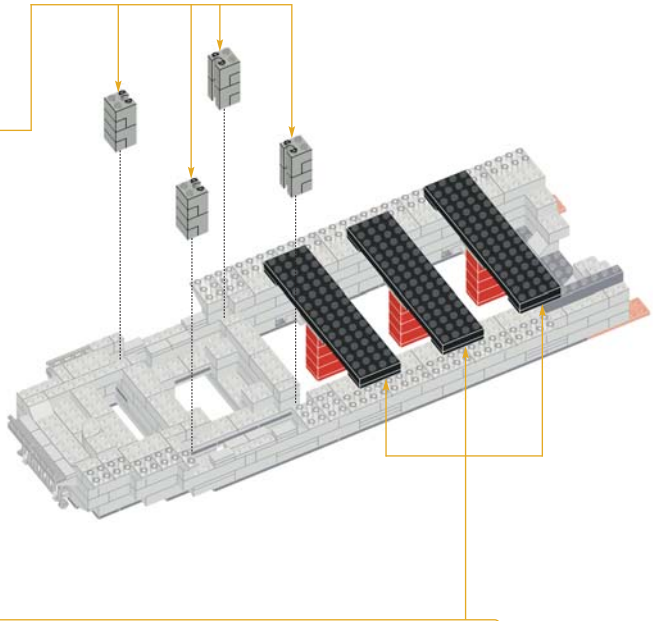
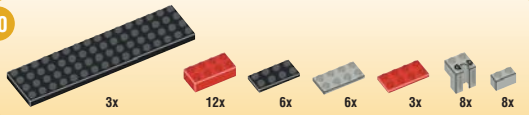

31

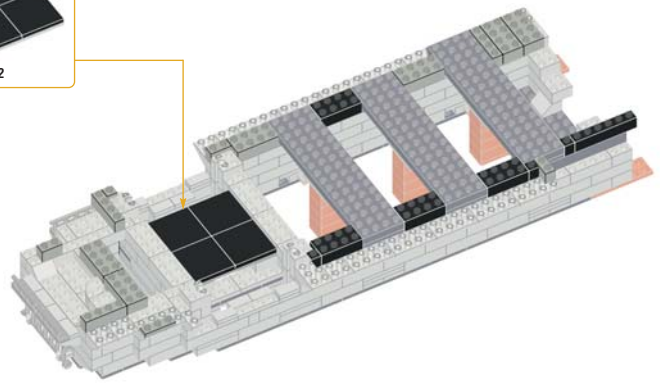
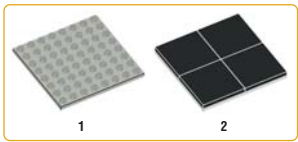
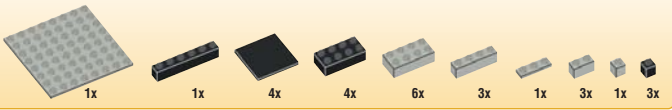

32

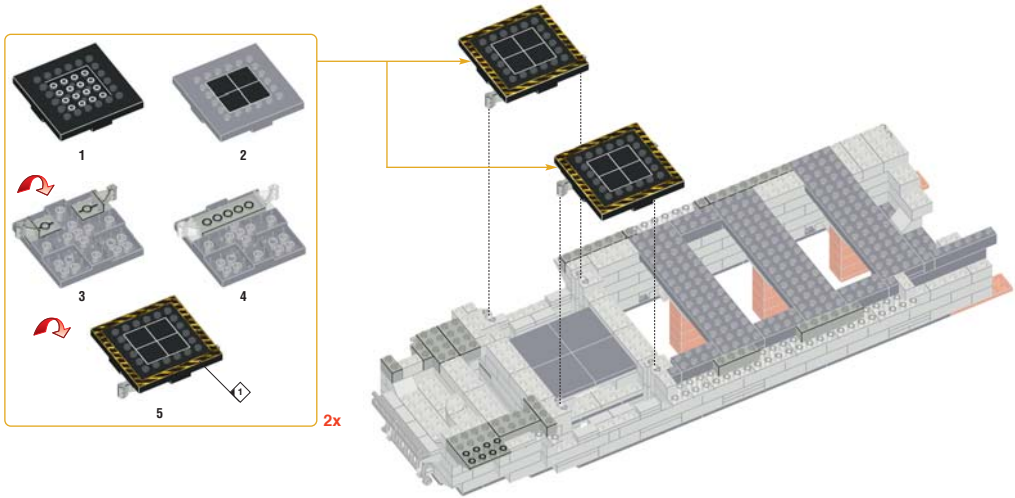
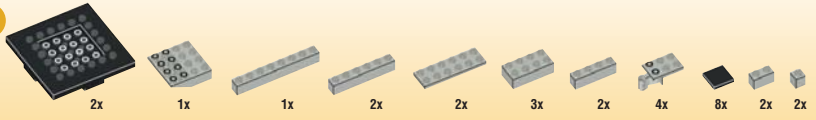

33

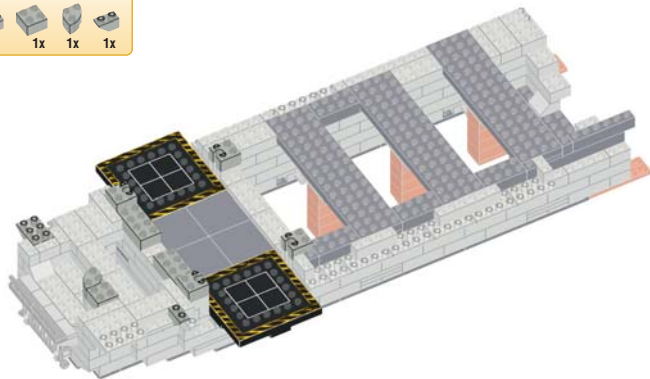

34

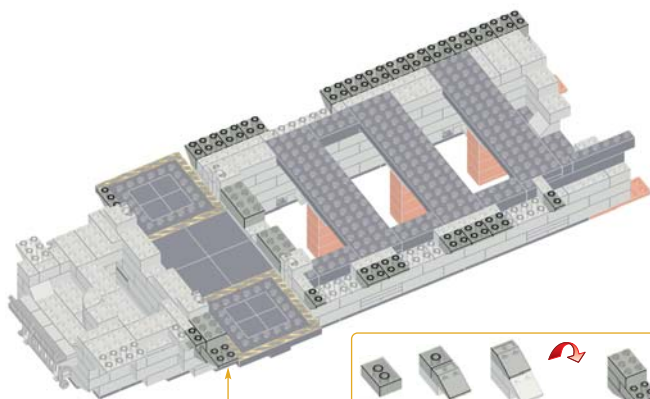

35

- 20x
- 3x
- 1x
- 1x
- 1x
- 4x
- 1x
- 1x

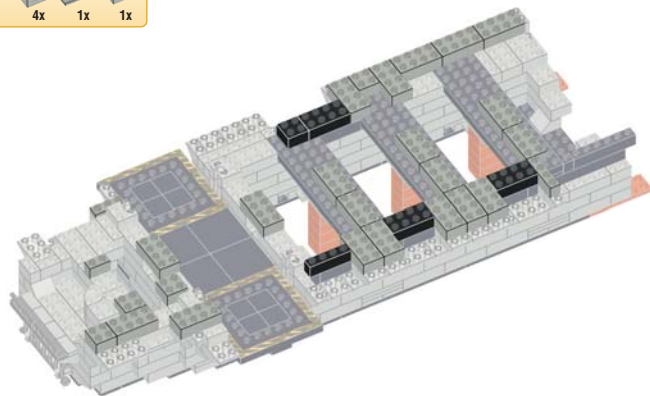

36

- 1x
- 4x
- 1x
- 1x
- 1x
- 2x
- 5x
- 2x
- 2x
- 2x
- 4x
- 1x

- 1
- 2

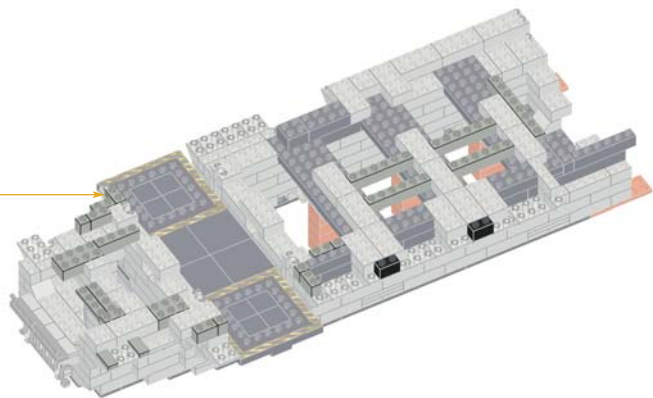

37

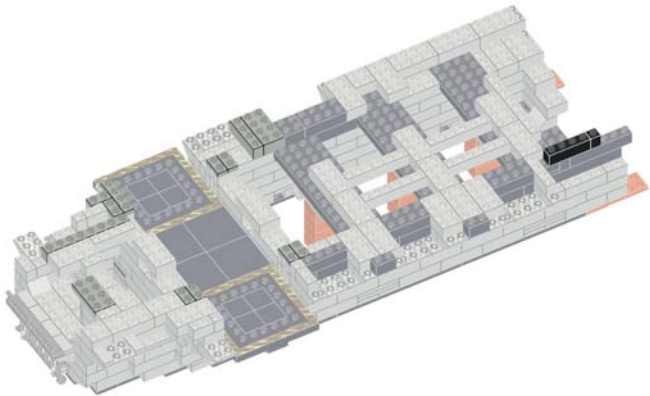
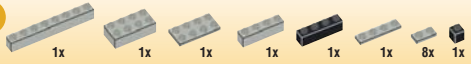

38



39

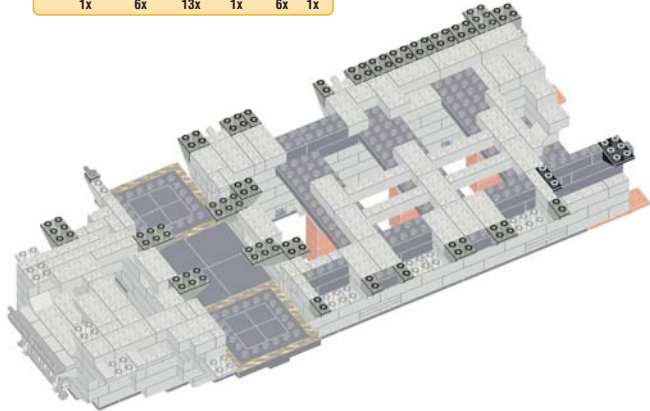

40

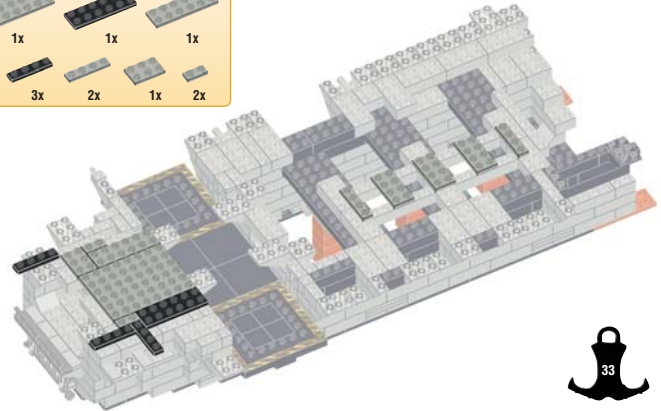
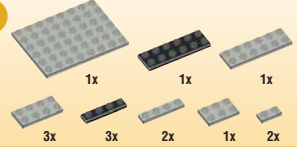

41

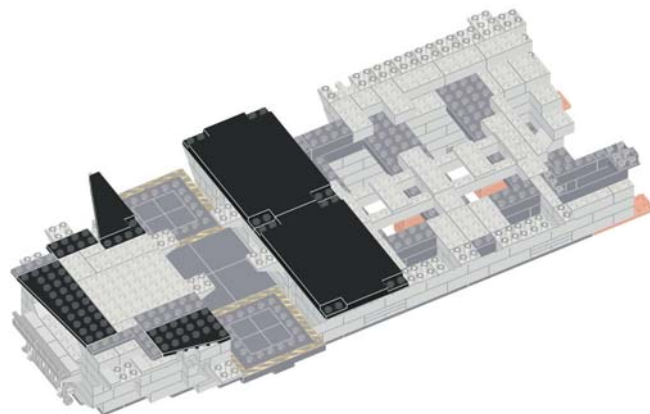
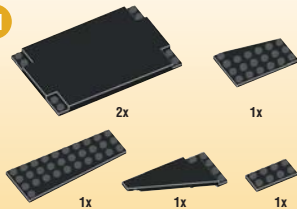

42

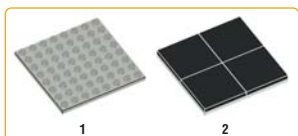
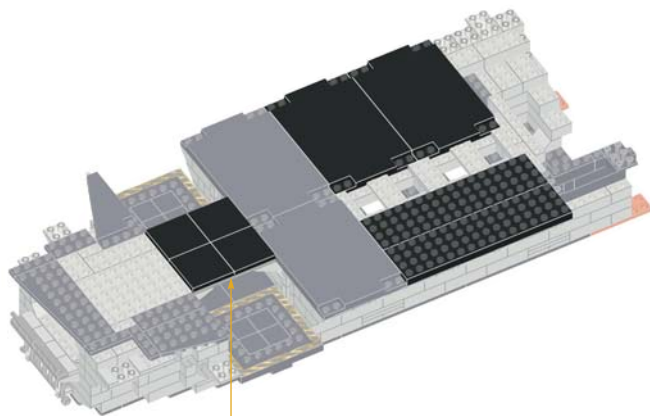
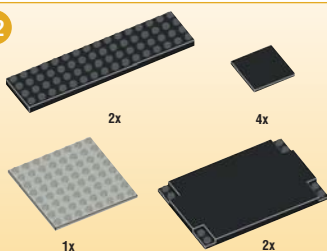

43



10x

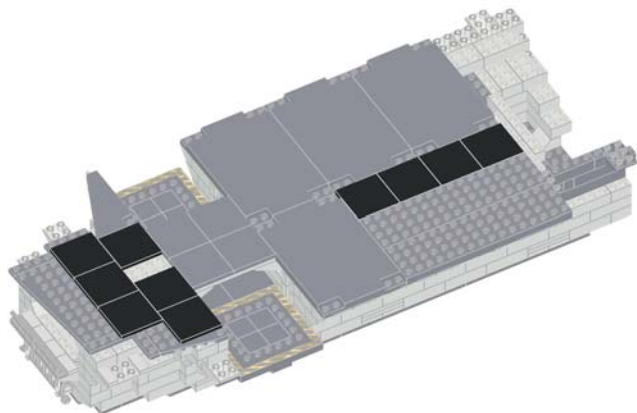

44

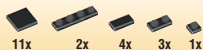

11x

2x

4x

3x

1x

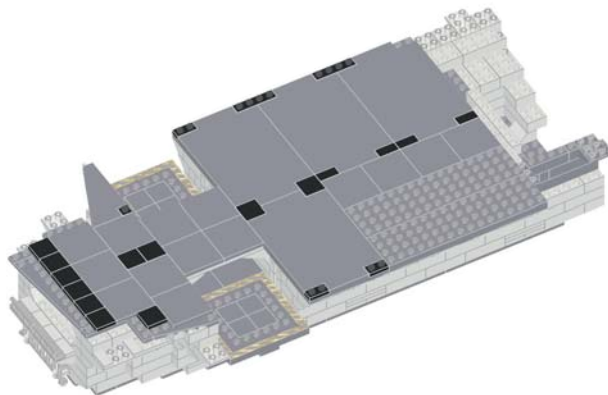

45

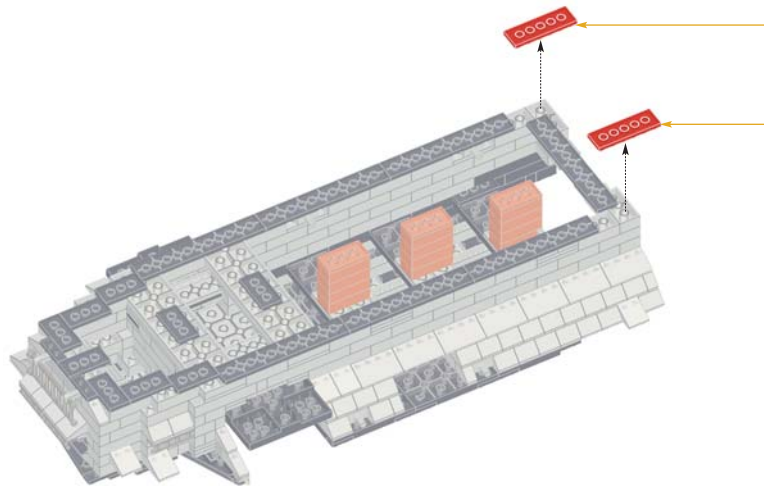

REMOVE TEMPORARY PIECES.
RETIRAR LAS PIEZAS PROVISIONALES.
ENLEVER LES PIÈCES TEMPORAIRES.
VERWIJDER TIJDELIJKEDELEN.

46

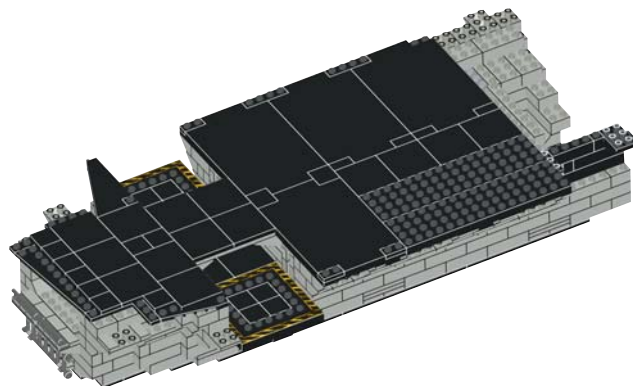

Section 4 • Sección 4
Section 4 • Decl 4

1

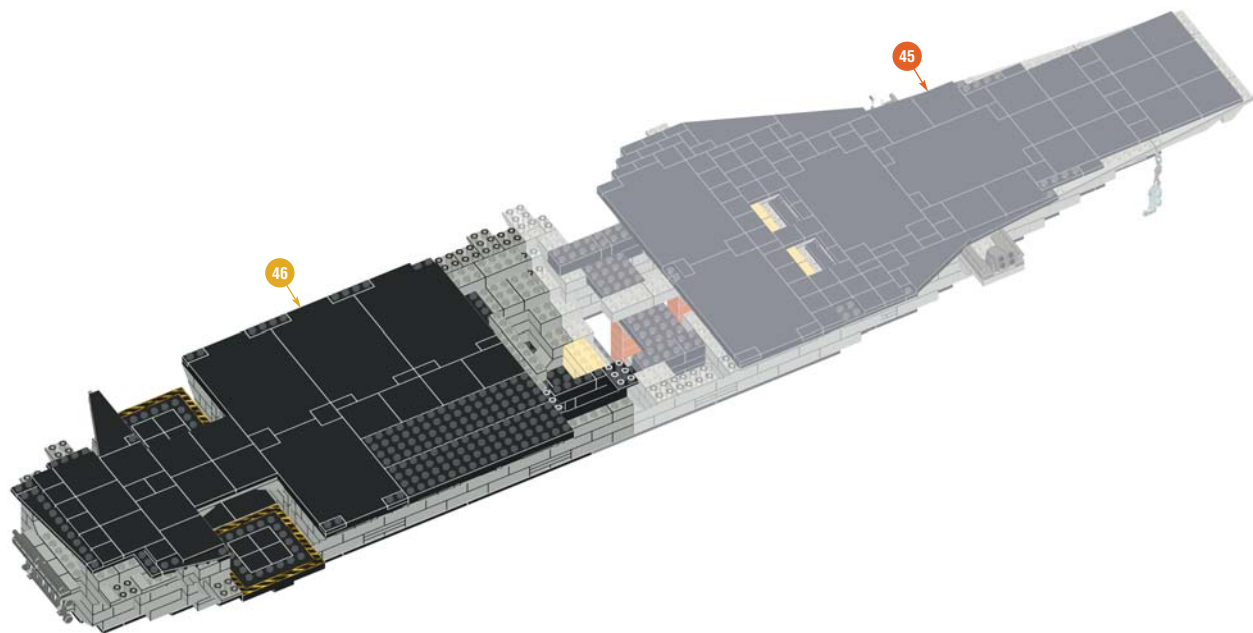

2



1



2



3



4



5



6

3



1x

2

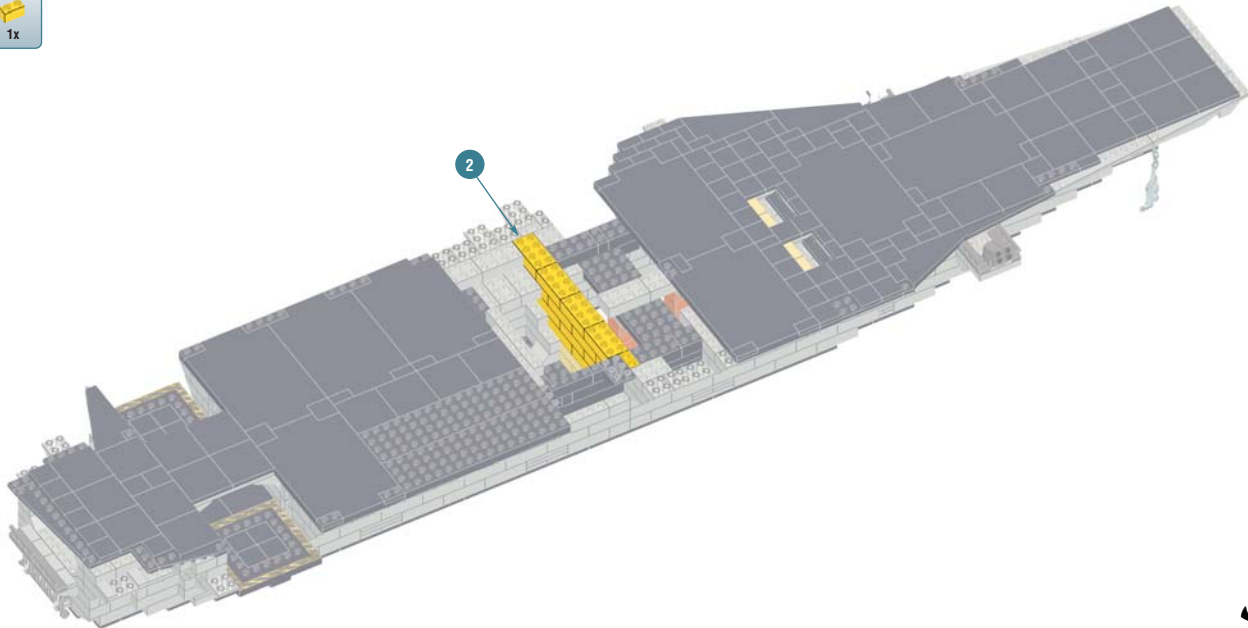

4

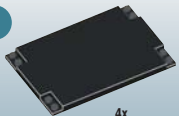

4x

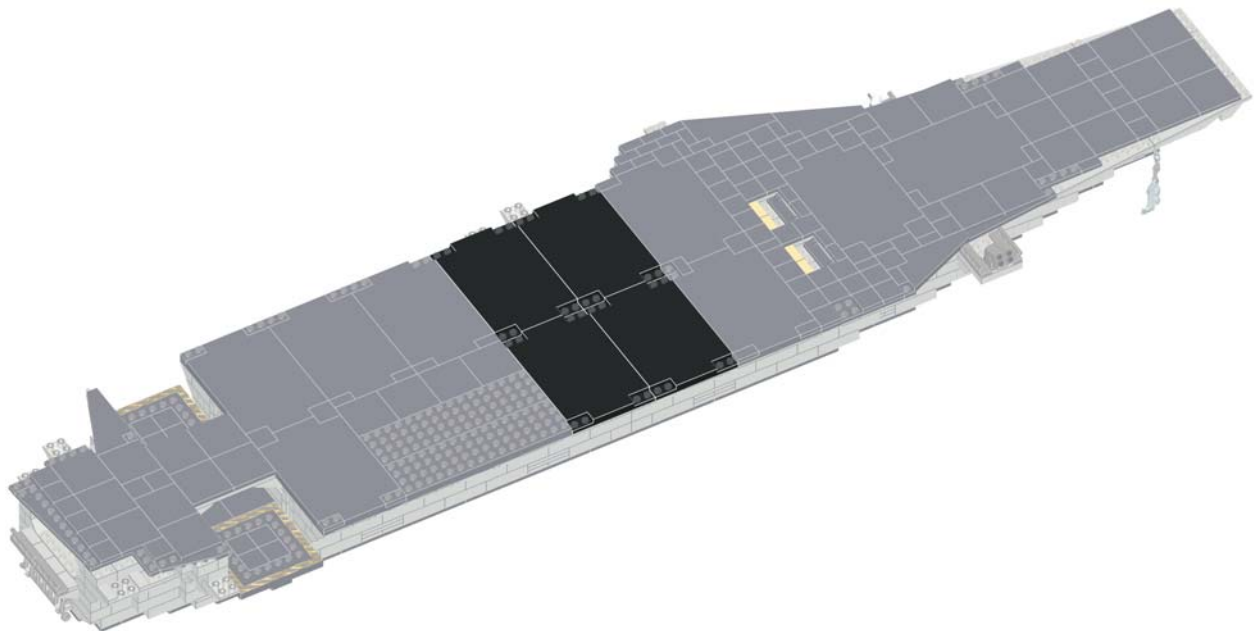

5



2x 3x 2x 6x

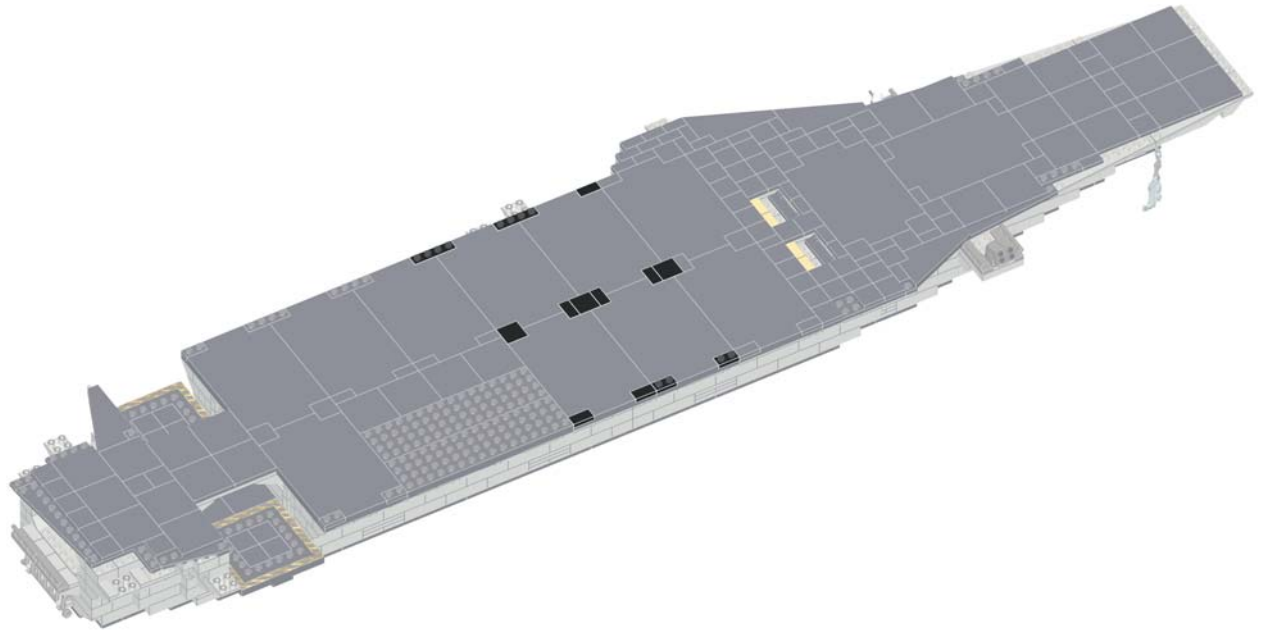

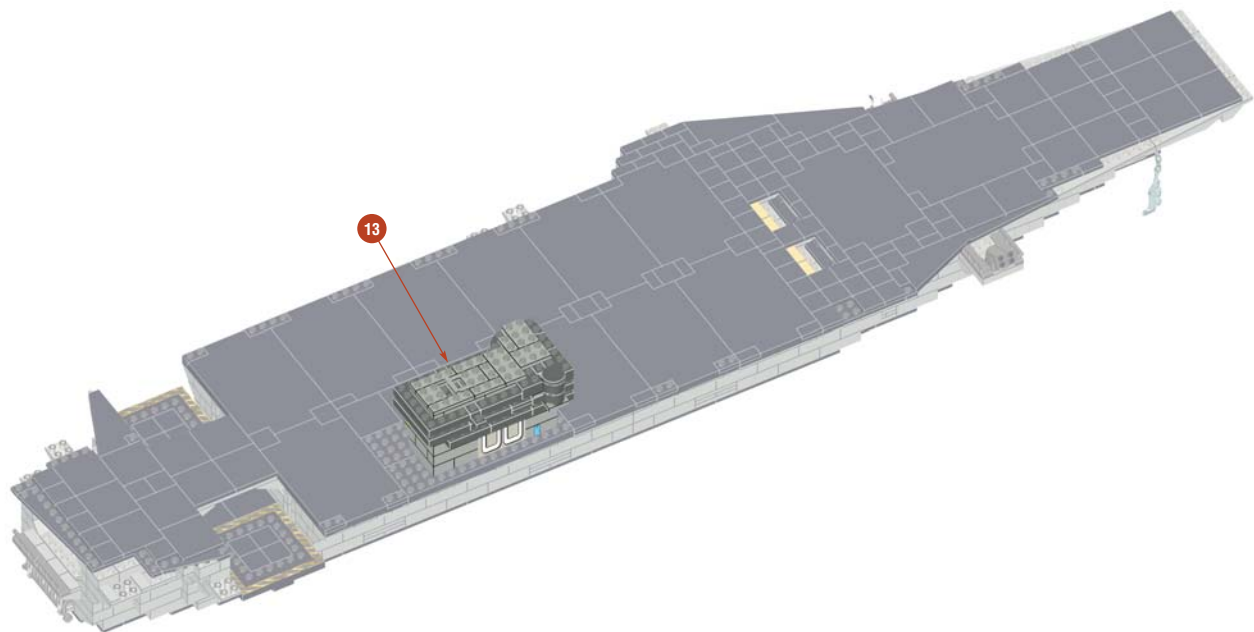

7

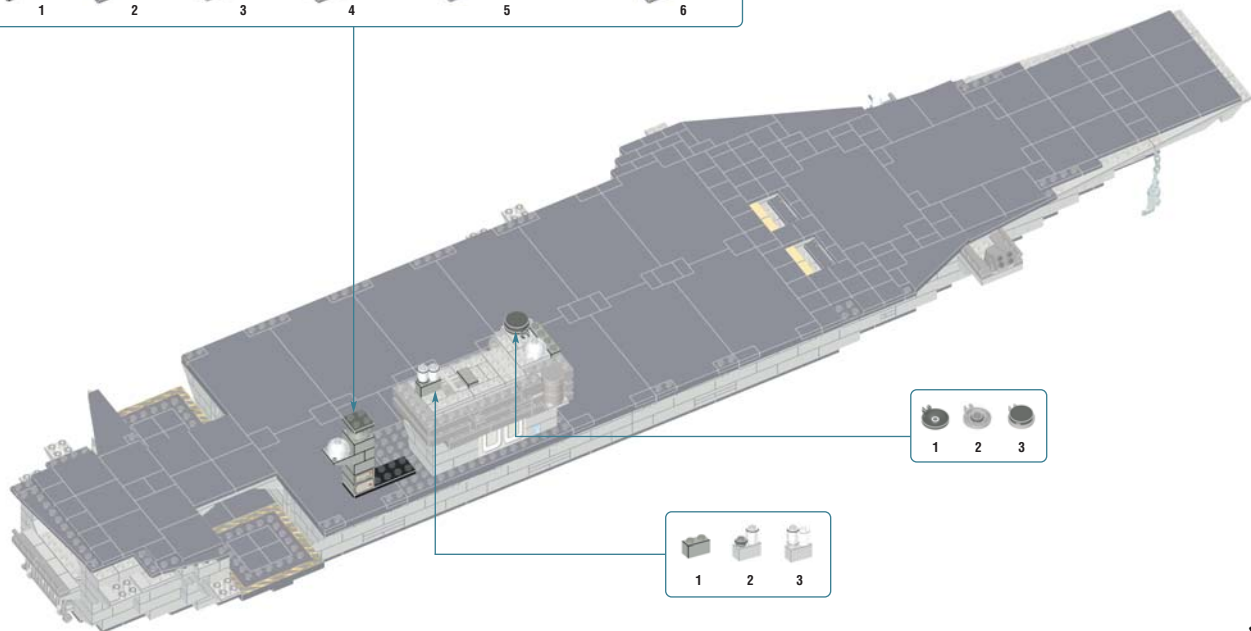
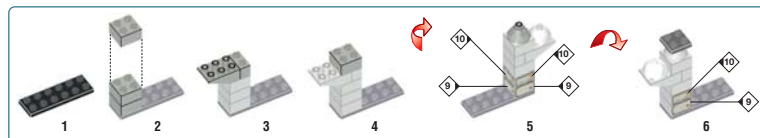

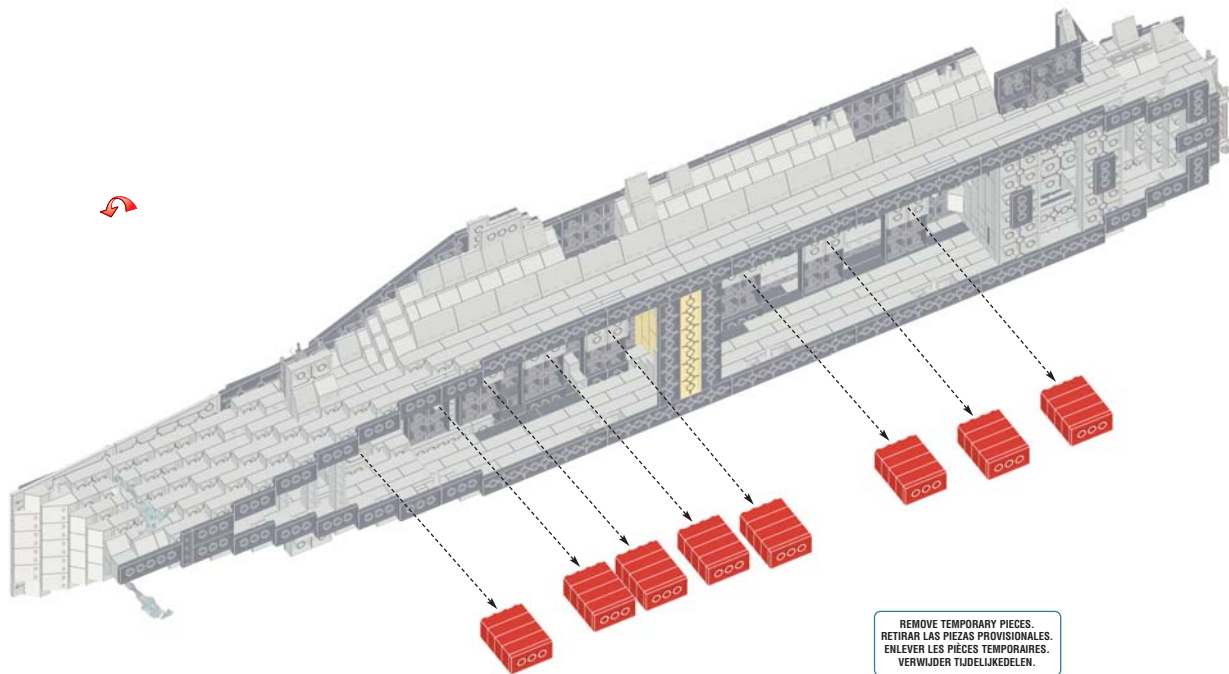

9



8x

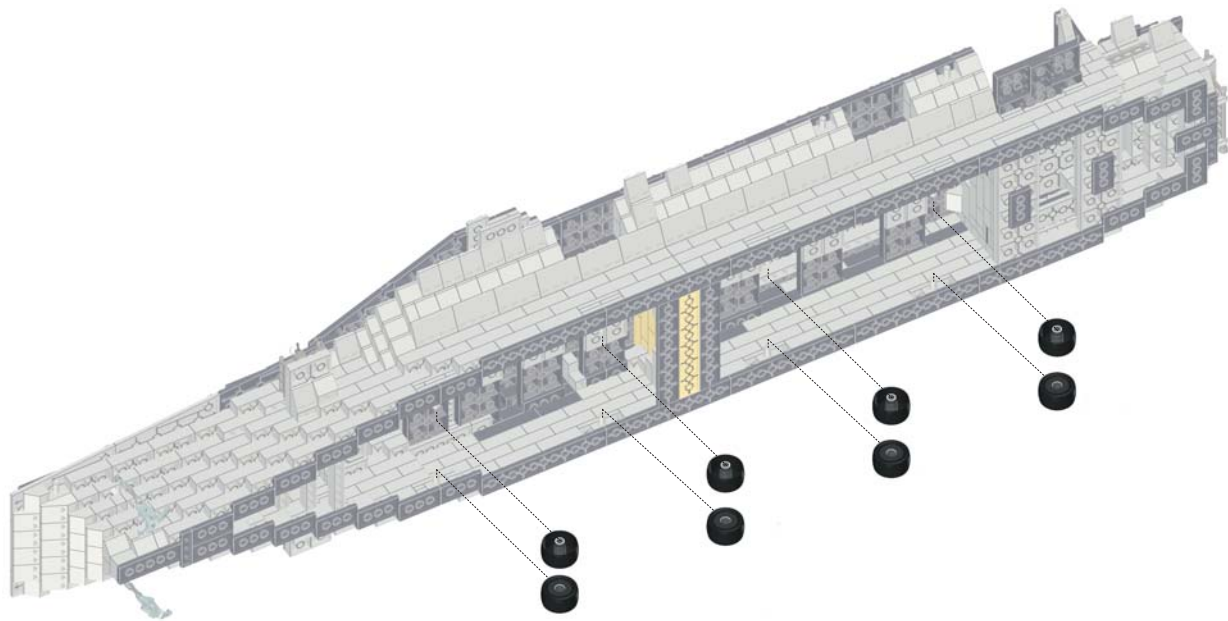

10
2x



11

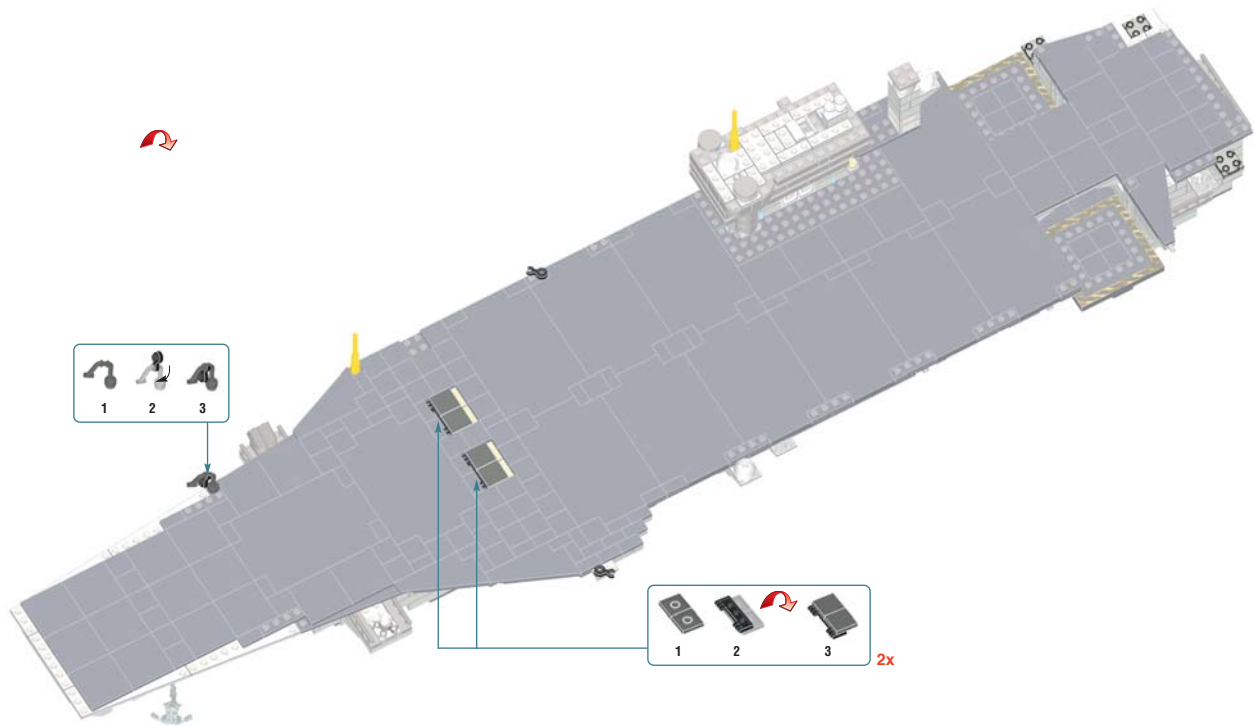
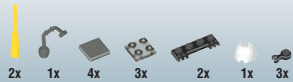

12

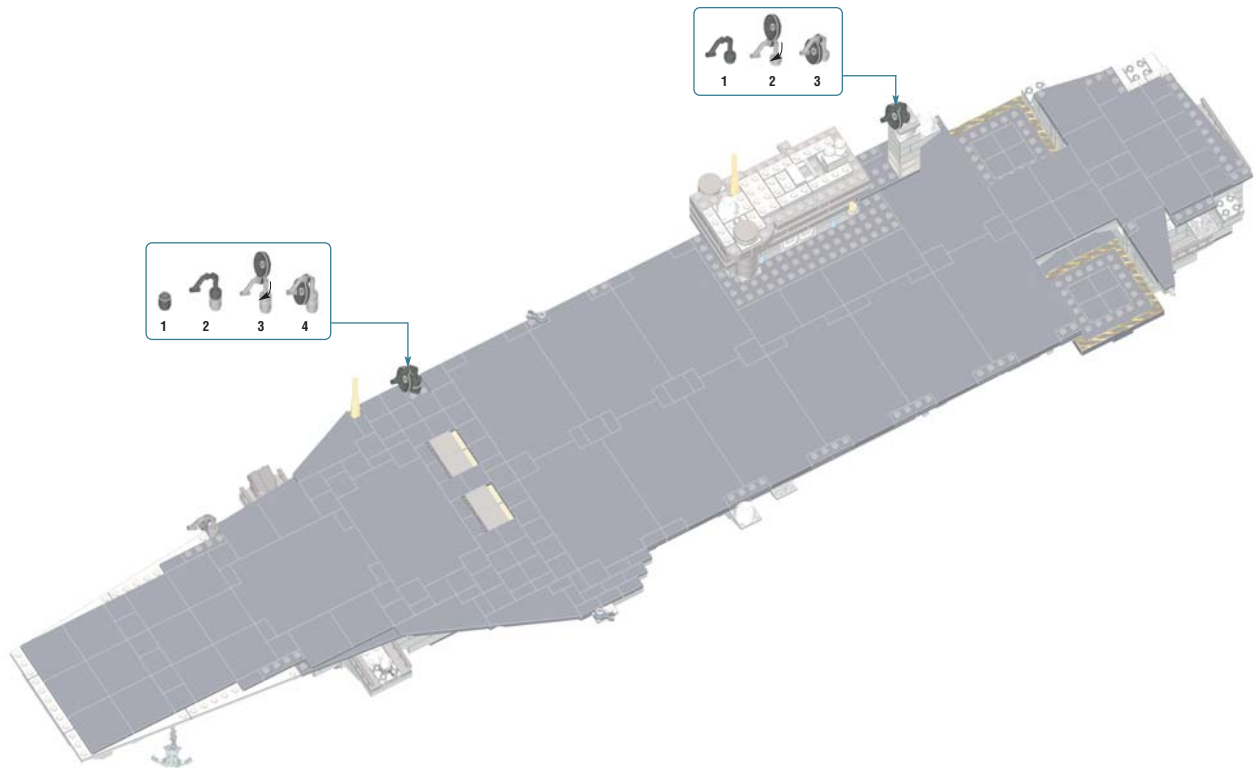

13

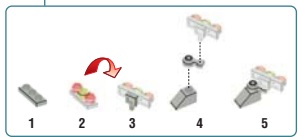
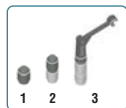
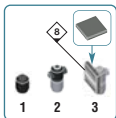
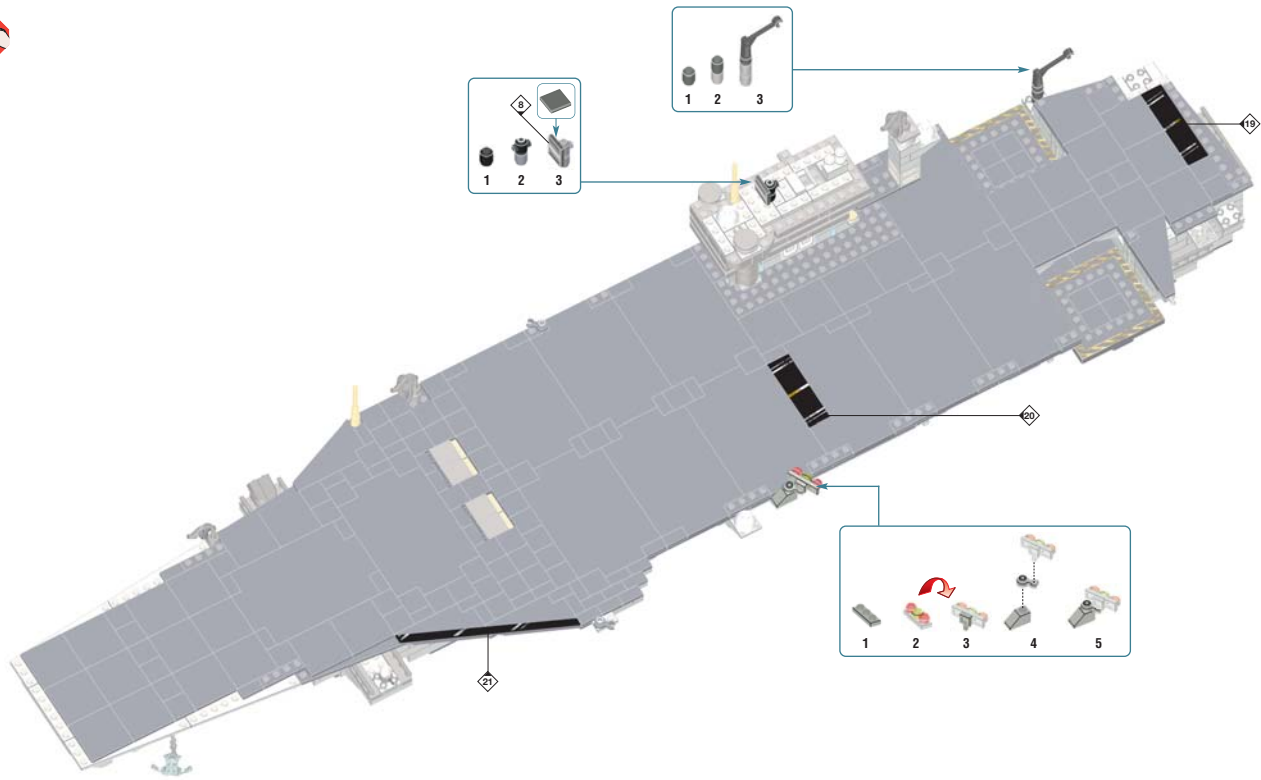

14

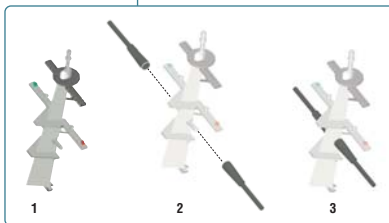
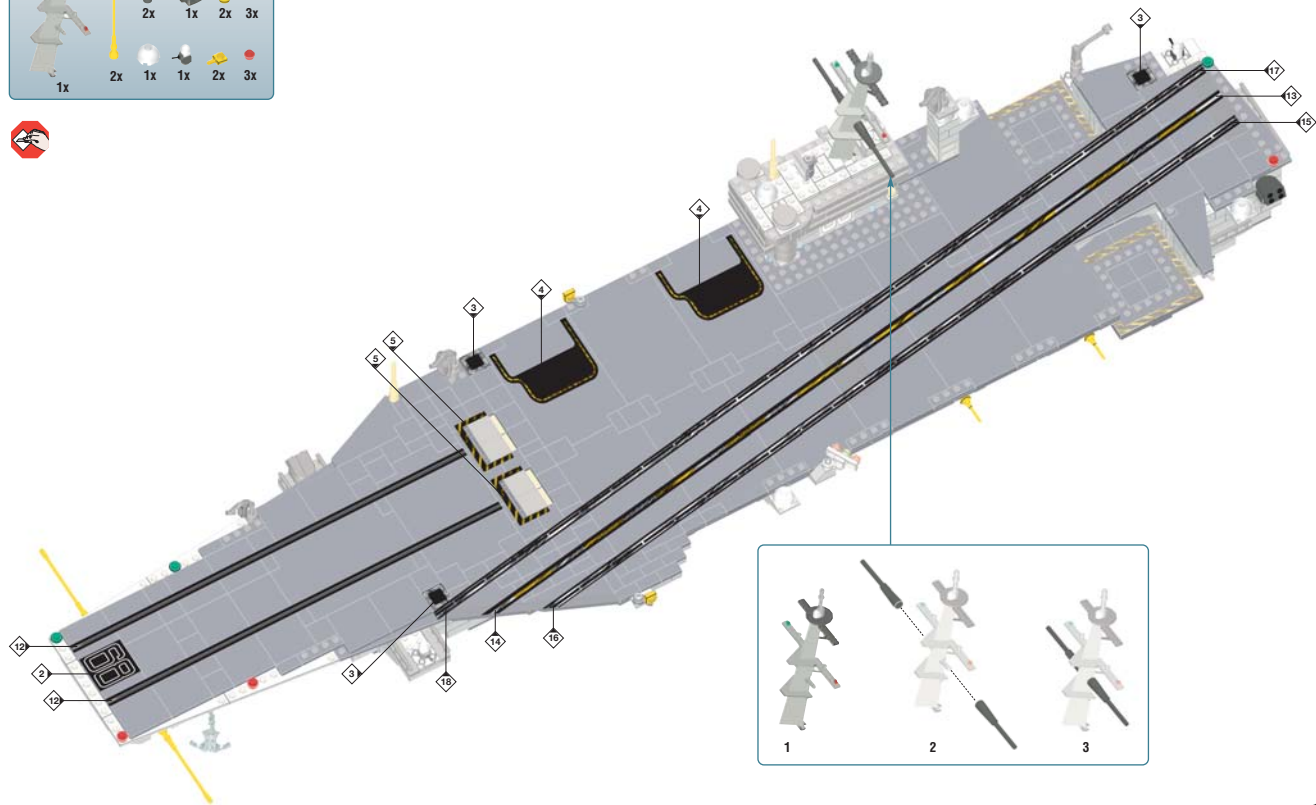
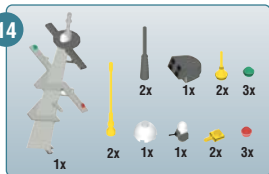

15



8x

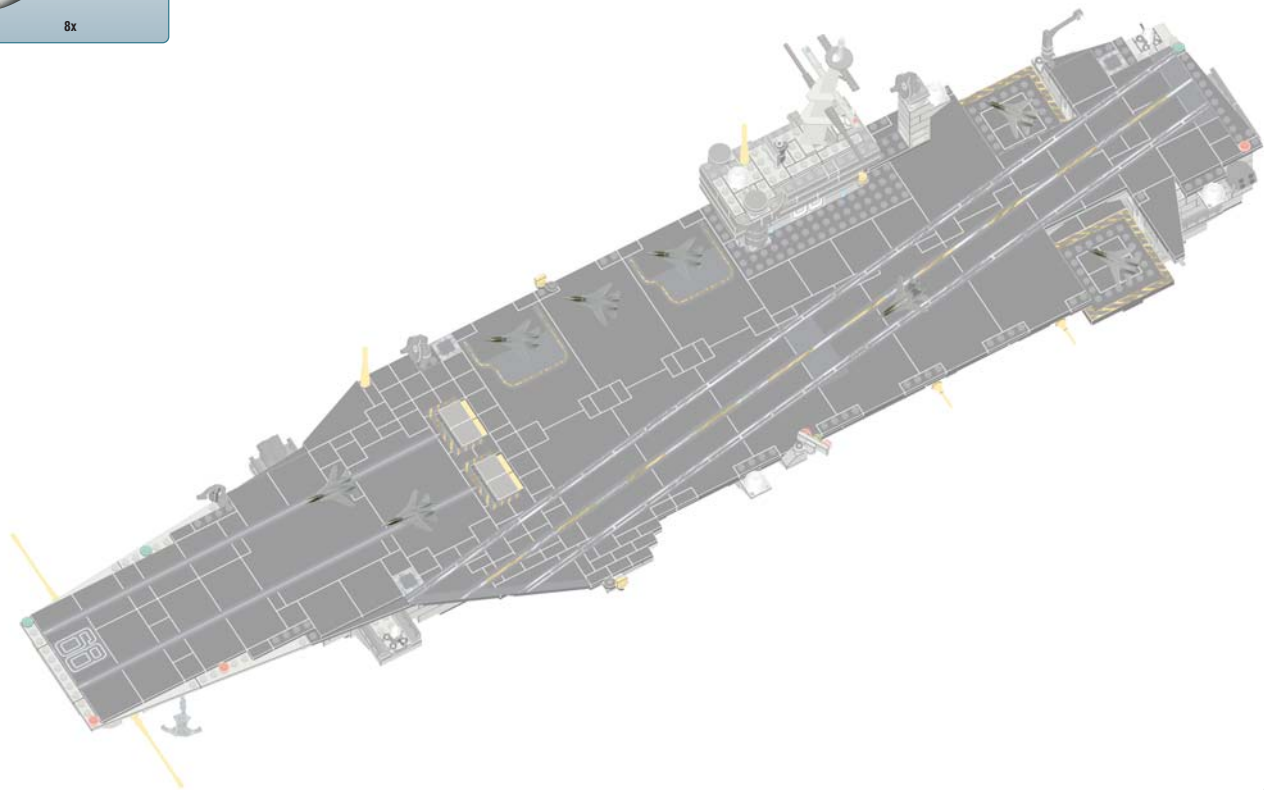

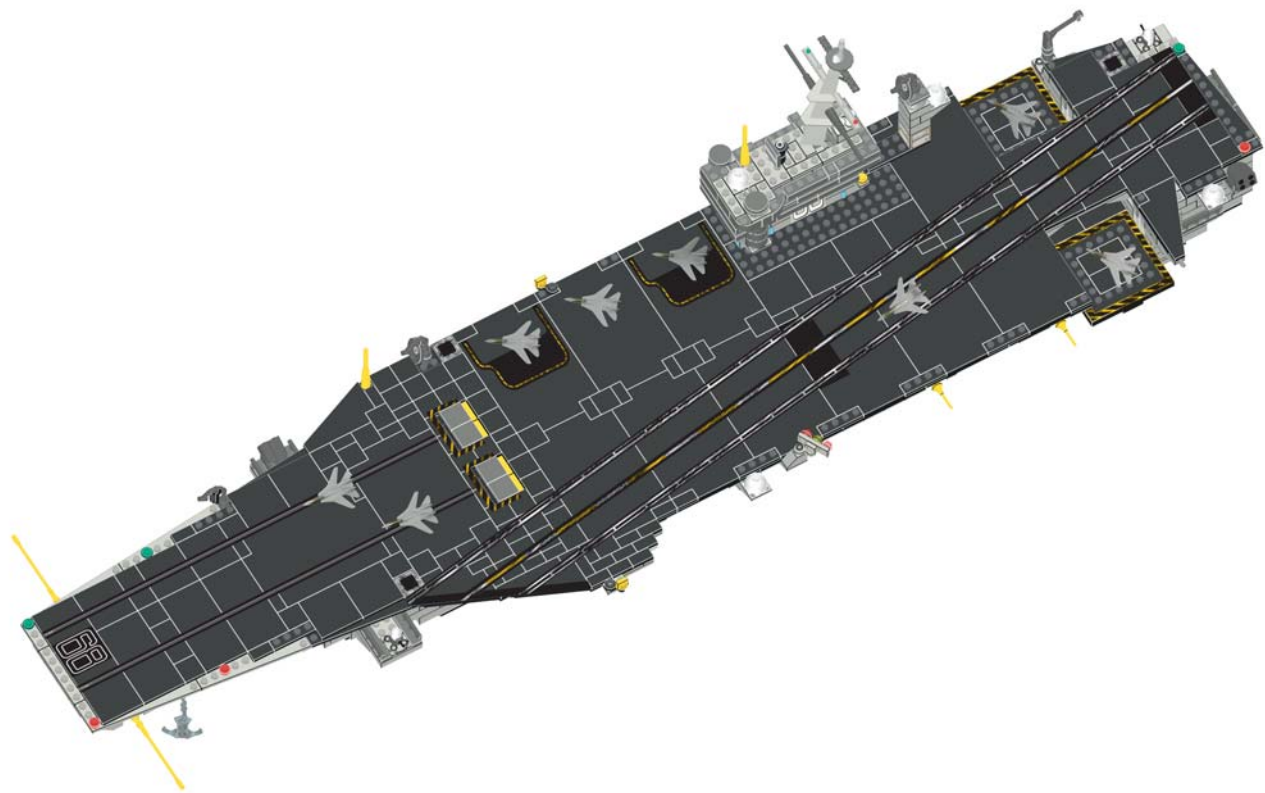

MEGA BLOKS

PROBUILDER

MASTER SERIES

9795

USS NIMITZ



Underside wheels for mobility and showcasing
Montado sobre ruedas para movilidad y muestra
Roues de support pour mobilité et exposition
Wielen aan de onderkant voor mobiliteit en etaleren

Flight deck elevators
Ascensores de cubierta de aterrizaje
Ascenseurs du pont d'envol
Vliegdeklijft



Also available
También disponible
Egalement disponible
Eveneens beschikbaar



Supersonic Fighter 9962



#8 Dale Earnhardt Jr. 9961



#24 Jeff Gordon 9960

NASCAR is a registered trademark of the National Association for Stock Car Auto Racing, Inc. All other trademarks are the property of their respective owners. © 2004 Mega Bloks Inc. All rights reserved. The names, logos and likenesses of Dale Earnhardt, Jr. as well as the other 3 race car drivers, are licensed under the authorization of Dale Earnhardt, Inc. Licensed by Dale Earnhardt, L.L.C. The official #8 race car of the Dale Earnhardt, Inc. race car program and the official #24 race car of the Jeff Gordon, Inc. race car program.



Rotating armament
Armaiento giratorio
Armes pivotantes
Roterende bewapening



Steam Express 9778



U.S.S. Enterprise NCC-1701-D 9777



Ford GT™ 9710



Air Force Warthog 9789

MEGA BLOKS

© 2004, MEGA BLOKS INC.
© and ™ denote trademarks of MEGA BLOKS INC.
© et ™ désignent la marque registered et la marque commerciale de MEGA BLOKS INC.
© et ™ désignent des marques de commerce de MEGA BLOKS INC.
© en ™ aanden op handelsmerken van MEGA BLOKS INC.

© & © Patent Pictures. All Rights Reserved.

Ford, Ford and Ford GT are registered trademarks owned and licensed by Ford Motor Company.