

ILLUMINATION
ENTERTAINMENT

minions



Scooter Escape | Fuite en scooter | Escape en vespa |
Escapada em Lambreta | Fuga in vespa | Scooter-Flucht
Uciezka skuterem | Scooterontsnapping | Побег на скутере

MEGA
BLOKS

1x
AM17003AGV

1x
AM75332W

2x
AM18560ZQ

1x
AM17062F

1x
AM17506F

1x
AM75956ZQ

1x
AM022501AGV

1x
AM17070AGV

2x
AM03773ZQ

2x
AS-CNF52-04

1x
AM74298ZQ

2x
AM73454AMC

1x
AM73198ZQ

1x
AM76527AMC

1x
AM72240F

1x
AM73195AMC

1x
AM73196AMC

2x
AS-CNF52-01

1x
AM18259F

1x
AM75954ZQ

1x
AS-CNF52-03

1x
AS-CNF54-01

1x
AM73197ZQ



Please read these instructions carefully before first use and keep them for future reference.
Il est recommandé de lire attentivement ce feuillet avant la première utilisation et de le conserver pour référence future.
Leer estas instrucciones cuidadosamente antes de la primera utilización y guardarlas para referencia futura.
Leia as instruções antes do primeiro uso e guarde-as para futura referência.
Leggere le istruzioni prima di cominciare ad usare il gioco e conservarle per referenze future.
Die Gebrauchsanleitung bitte durchlesen und aufbewahren.



Proszę uważnie przeczytać instrukcję obsługi przed pierwszym użyciem, a następnie zachować ją na przyszłość.
Wij raden u aan deze handleiding zorgvuldig te lezen en te bewaren voor eventuele raadpleging op een later tijdstip.
Внимательно прочитайте инструкцию перед первым использованием и сохраните ее для дальнейшего использования.
Vær venlig at læse disse instruktioner omhyggeligt inden ibrugtagen og opbevar dem til fremtidigt brug.
Läs noggrant igenom dessa instruktioner innan du använder produkten för första gången och spara dem för ev. framtida frågor.
Les disse instruksjonene nøye før første gangs bruk, og ta vare på dem for fremtidige oppslag.
Lue nämä ohjeet huolellisesti ennen ensimmäistä käyttöä ja säilytä ne myöhemmää tarvetta varten.

Διαβάστε αυτές τις οδηγίες προσεκτικά πριν χρησιμοποιήσετε το προϊόν για πρώτη φορά και φυλάξτε τις για μελλοντική αναφορά.
يرجى قراءة هذه التعليمات بدقة قبل البدء بالاستعمال والاحتفاظ بها كمرجع للمستقبل
请在初次使用前仔细阅读这些指示，并保留它们以便未来参考。

初めてご使用になる前に、この説明書をよくお読みください。また、本書は将来いつでも参照できるように保管してください。

⚠ WARNING :
CHOKING HAZARD. - Small parts.
Not for children under 3 years.

⚠ ATTENTION :
DANGER D'ÉTOUFFEMENT. - Présence de petits éléments.
Ne convient pas aux enfants de moins de 3 ans.

⚠ تحذير :
خطر الاختناق - قطع صغيرة.
غير صالحة للأطفال أقل من 3 سنوات.

⚠ 警告:
噎住危険。包含有小部件
不适合3岁以下的小孩玩。

⚠ 警告:
のどにつまる危険 小さな部品が含まれています
3歳以下の子供には与えない下さい。

ADVERTENCIA: Peligro de asfixia. Juguete no recomendado para menores de 3 años, porque contiene piezas pequeñas que podrían provocar asfixia en caso de ser ingeridas o inhaladas por el/la niño/a.

ATENÇÃO: Não recomendável para crianças com menos de 36 meses. Contém peças pequenas capazes de criar risco de asfixia.
ATTENZIONE: Contiene pezzi di piccola dimensione.

ACHTUNG: Kleine Teile.
OSTRZEŻENIE: Małe części
WAARSCHUWING: Kleine onderdelen
ПРЕДУПРЕЖДЕНИЕ: Мелкие детали

ADVARSEL: Små dele.
VARNING: Smådelar
ADVARSEL: Små deler.

VAROITUS: Pieniä osia
ΠΡΟΣΟΧΗ: Περιλαμβάνονται μικρά κομμάτια.





1x



1x



1



2



1x



1x



1x

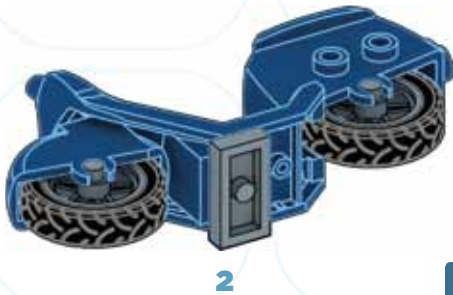
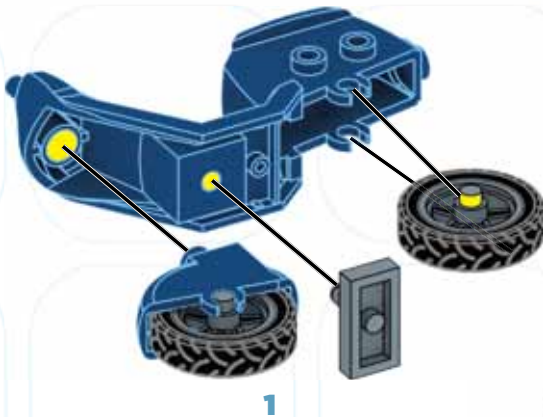



1x



2x



2x

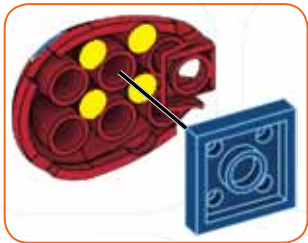
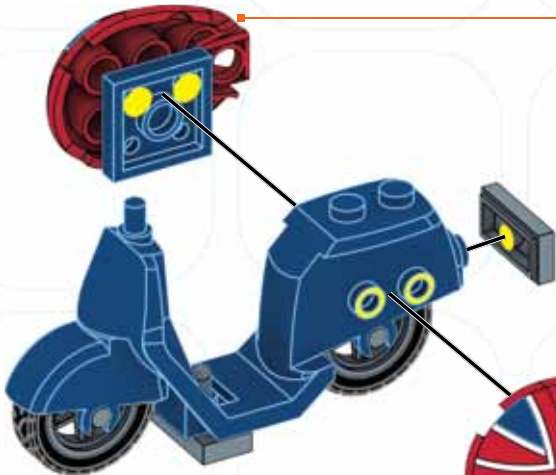
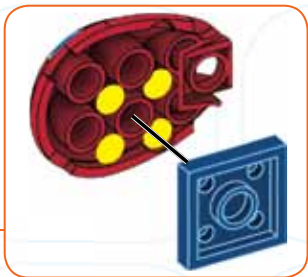



1x



1x





5



1x



1x

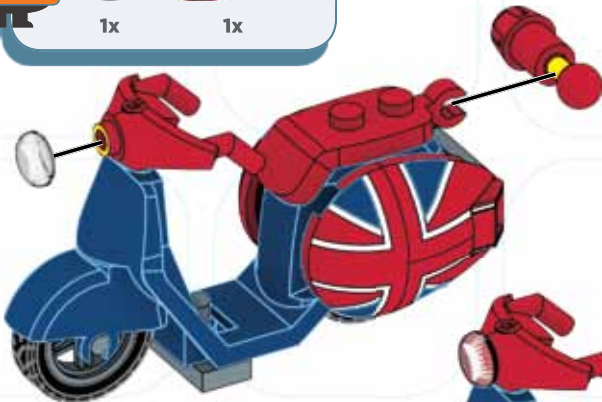

1



2



1x



1x



1x



1x

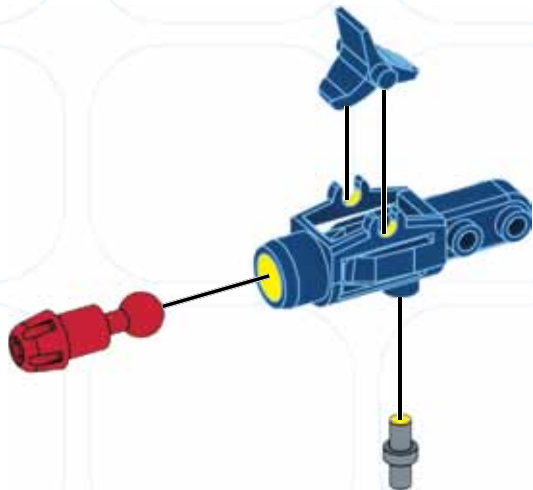

1



2

9



2x



1x



1x



1x

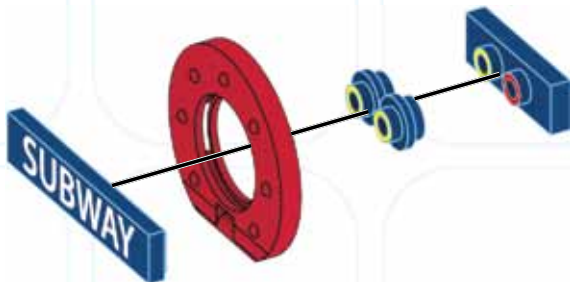



1x



1x



1x



1x



1



2



3





Warning: Do not aim at eyes or face. Only use projectiles supplied with this toy. Do not fire at point blank range.

Attention : Ne pas viser les yeux ou le visage. Ne pas utiliser d'autres projectiles que ceux fournis avec ce jouet. Ne pas tirer à bout portant.

Advertencia: No apuntar hacia los ojos o la cara. Utilizar exclusivamente los proyectiles suministrados con este juguete. No disparar a quemarropa.

Atenção! Não apontar para os olhos e para a face. Não utilizar projéteis diferentes dos providos. Não disparar excessivamente perto do alvo.

Attenzione: Non puntare agli occhi o al viso. Usa solo i proiettili forniti con il giocattolo. Non sparare a distanza ravvicinata.

Achtung: Nicht auf Augen oder Gesicht zielen. Nur die zu diesem Spielzeug gehörenden Projektile verwenden. Nicht auf Menschen oder Tiere oder aus nächster Nähe zielen.

Ostrzeżenie: Nie celuj w oczy ani w twarz. Używaj wyłącznie rzutek BOOMco.™. Nie strzelaj z bliska.

Waarschuwing: niet op ogen of gezicht richten. Gebruik uitsluitend de bijgeleverde projectielen. Niet van te dichtbij afschieten.

Предупреждение: Не направляйте в глаза или лицо. Используйте только детали, входящие в комплект. Не стреляйте со слишком близкого расстояния.

Advarsel: Sigt ikke mod øjne eller ansigt. Brug kun de projektiler, som følger med legetøjet. Skyd ikke direkte på personer eller ting.

Varning! Sikta inte mot ögon eller ansikte. Använd endast projektiler som medföljer leksaken. Fyra inte av på mycket nära håll.

Advarsel: Du må ikke sikte mot øyne eller ansikt. Bruk bare prosjektilene som følger med leken. Ikke skyt på noe på kloss hold.

Varoitus: Älä tähtää silmiin äläkä kasvoihin. Käytä ainoastaan tämän tuotteen mukana tulleita ammuksia. Älä ammu lähietäisyydeltä.

Προσοχή: Μη στοχεύετε στα μάτια ή στο πρόσωπο. Χρησιμοποιείτε μόνο τα βλήματα που περιλαμβάνονται. Μη στοχεύετε προς ανθρώπους ή ζώα.

تحذير: يجب عدم التصويب باتجاه العينين أو الوجه. يجب استخدام المقذوفات المزودة مع هذه اللعبة فقط. يجب عدم الإطلاق من مدى قريب.

警告: 请勿对着眼睛或脸部发射。仅使用本玩具自带的抛射物。请勿近距离射击。

警告: 目や顔を狙わないでください。このおもちゃに同梱されている発射物のみ使用するよう to してください。到達可能な距離内で火を燃やさないでください。

**Collect them all! / Collectionnez-les tous! / ¡Colecciónalos todos! /
Colecione todos eles! / Collezionali tutti! / Sammele sie alle! / Zbierz je
wszystkie! / Verzamel ze allemaal! / Ты можешь собрать их всех!**

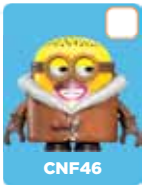
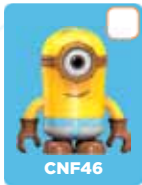
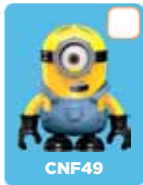
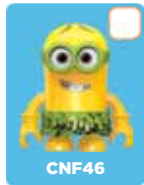
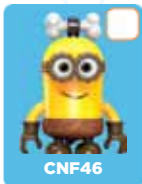
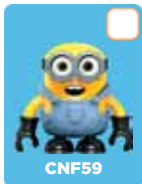
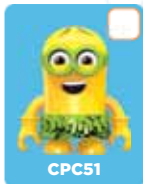
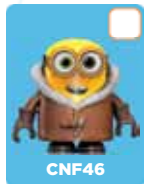
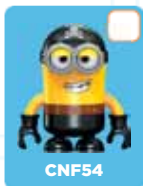

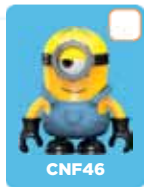

CNF46

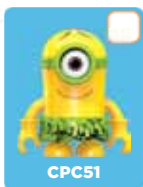

CPC51

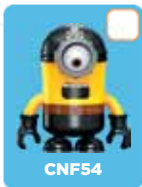

CNF54



CNF52



CNF54

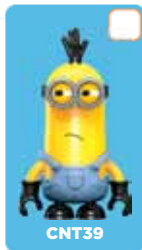

CNT39

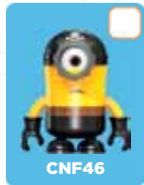

CNF46



CNF56

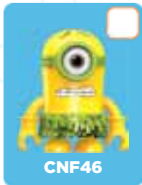

CNF46



CNF56



CNF55



CNF60



CNT39



CNF55



CNF60

Each sold separately and subject to availability. / Tous vendus séparément. Certains produits peuvent ne pas être commercialisés. / Se venden por separado y están sujetos a disponibilidad. / Vendidos em separado e sujeitos à disponibilidade. / Ognuno in vendita separatamente secondo disponibilità. / Alle Artikel separat erhältlich. Einige Artikel werden nicht in allen Ländern vertrieben. / Sprzedawane oddzielnie w zależności od dostępności. / Per stuk verkrijgbaar en niet overal leverbaar. / Каждый продукт продается отдельно, в зависимости от наличия. / Sælges separat og så længe lager haves. / Alla delar säljs separat så långt lagret räcker. / Hver leke selges separat så langt lageret rekker. / Jokainen myydään erikseen, saatavuus voi vaihdella. / Το καθένα πωλείται ξεχωριστά και ανάλογα με τη διαθεσιμότητα. /

تباع كل منها على حدة وتخضع لتوفرها.

每件单独出售，并且视库存情况而定。 / それぞれ在庫状況に従って個別に販売されます。

ILLUMINATION
ENTERTAINMENT

minions



UNIVERSAL ILLUMINATION
ENTERTAINMENT

minionsmovie.com #minions

Minions is a trademark and copyright
of Universal Studios. Licensed by Universal
Studios Licensing LLC. All rights reserved.



CNF51



CNF54



©2015, MEGA Brands Inc. ® & ™ MEGA Brands Inc.
Printed in China AD-CNF52-01

MINIONS.MEGABLOKS.COM