

# SpongeBob SQUAREPANTS

1



Bad Neighbours Set | Ensemble de Méchants Voisins | Set Malos Vecinos  
Conjunto de Maus Vizinhos | Set Cattivi Vicini | Böse-Nachbarn-Set  
Zestaw Złe Sąsiedztwo | Foute-buren-set | Набор "Плохие соседи"

MEGA  
BLOKS

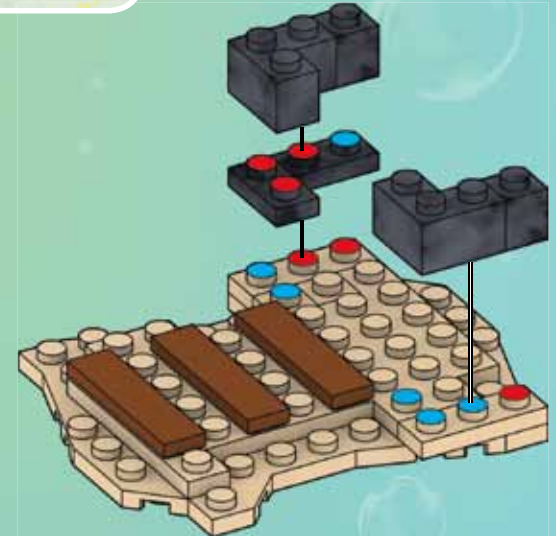
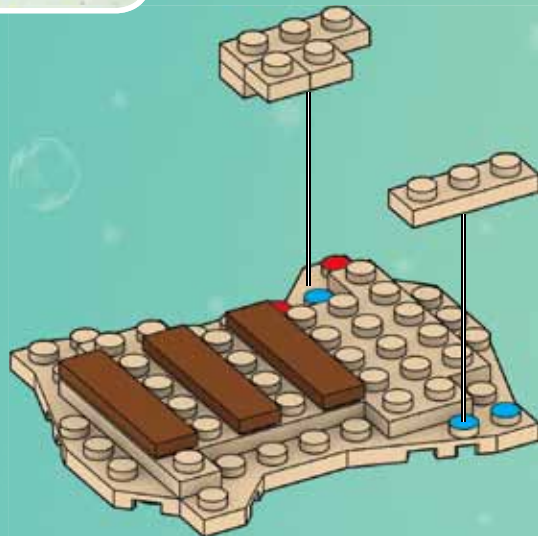
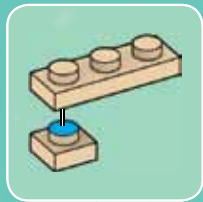
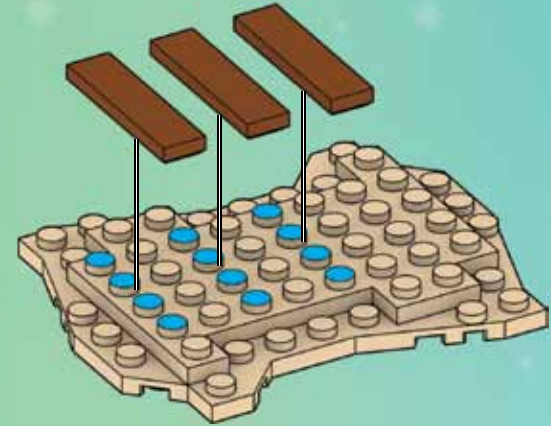
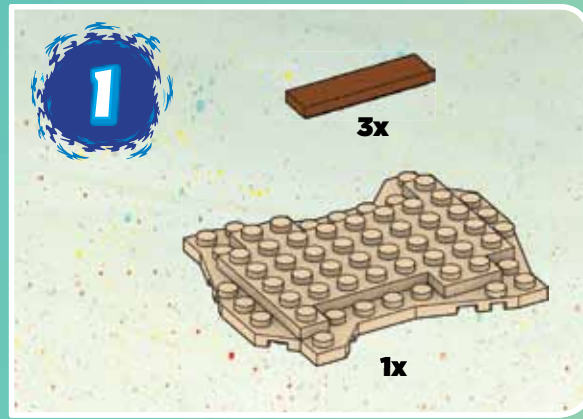

**4**

1x 2x

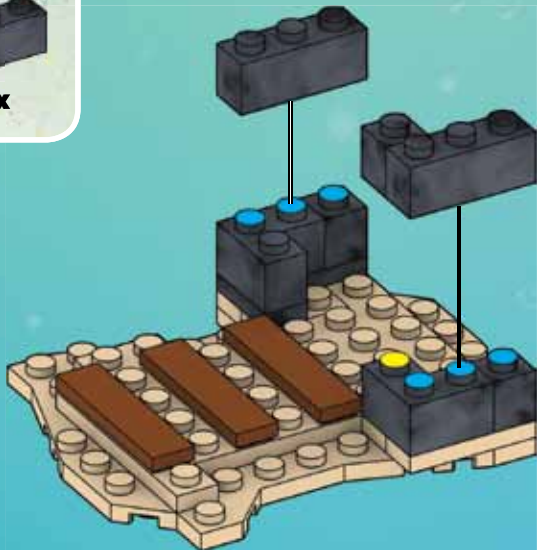

**5**

2x 2x



**6**

2x 2x

1x 1x 1x

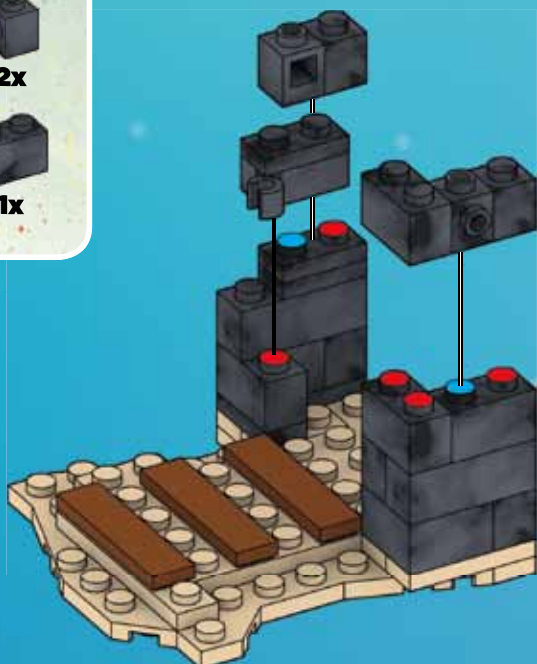

**7**

2x

1x 1x

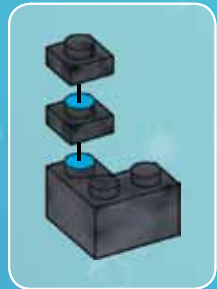

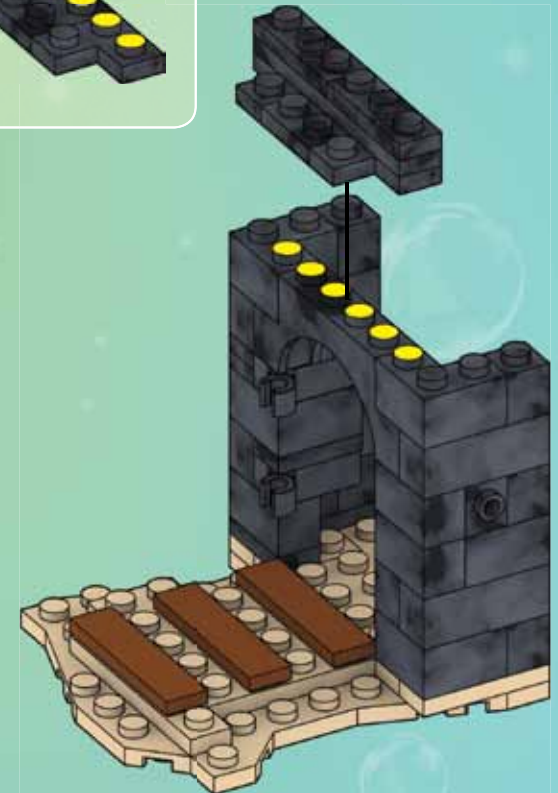
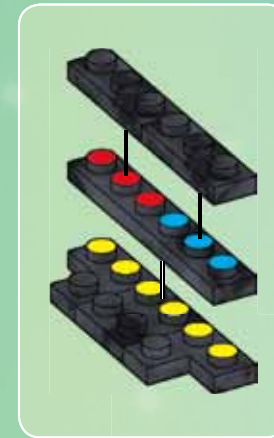
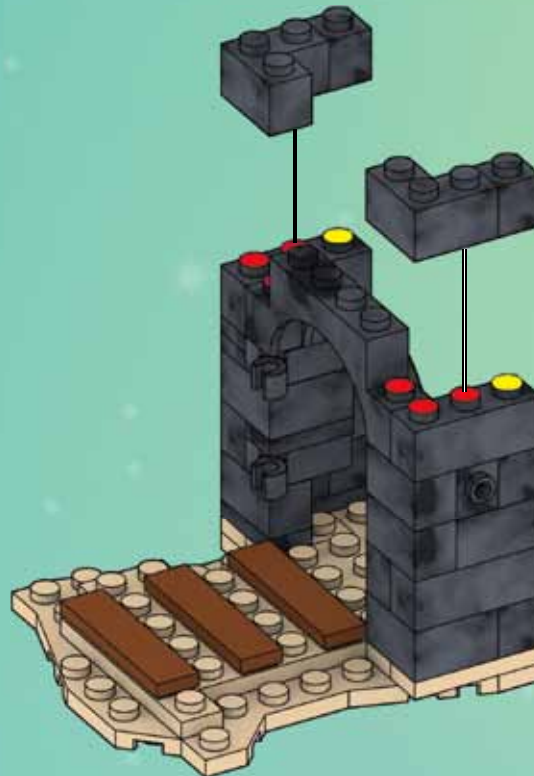
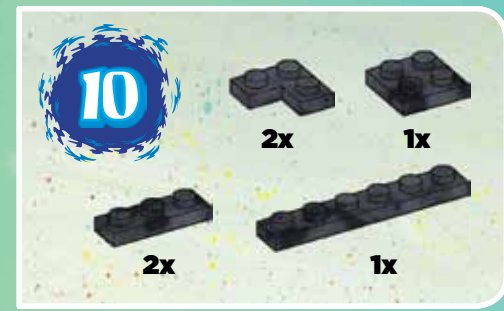

11



2x



2x

12



2x

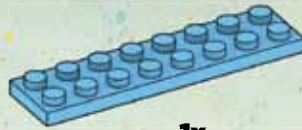

1x

13



2x



4x



2x

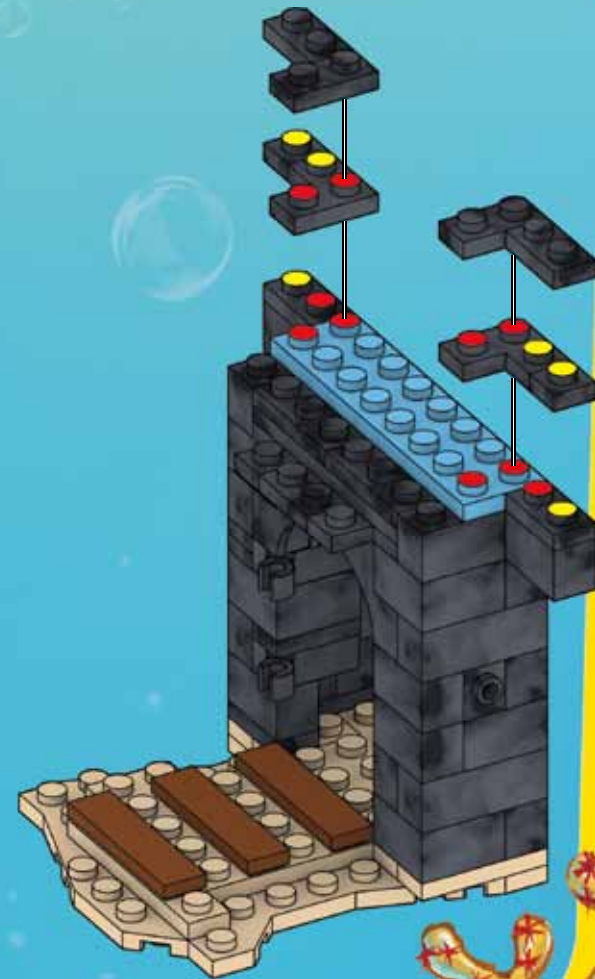

14



2x

15



2x



2x



2x



1x

16



2x



2x



17



2x



1x

18



2x



2x

19



4x



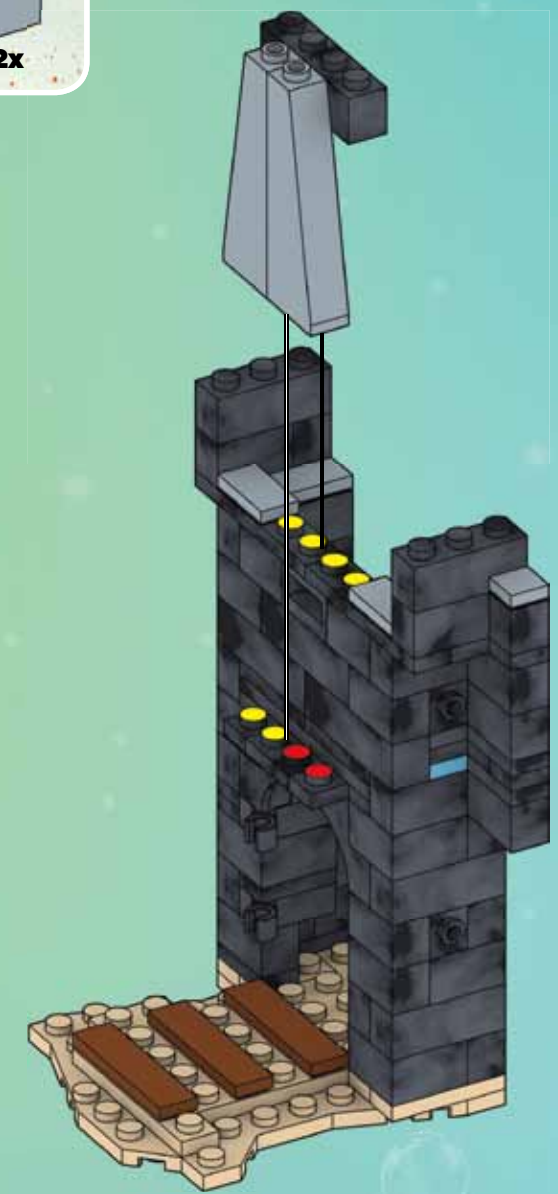
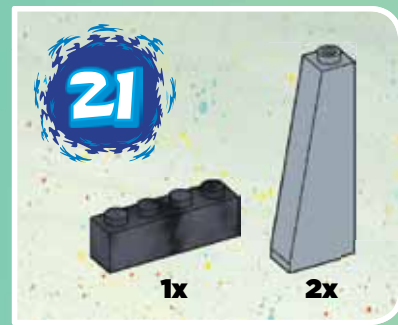



22



2x

23



2x



4x



6x



2x



2x



1x



3x



1x



1x

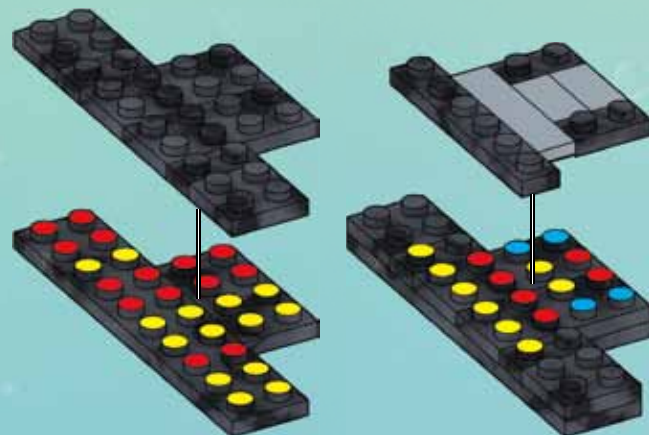
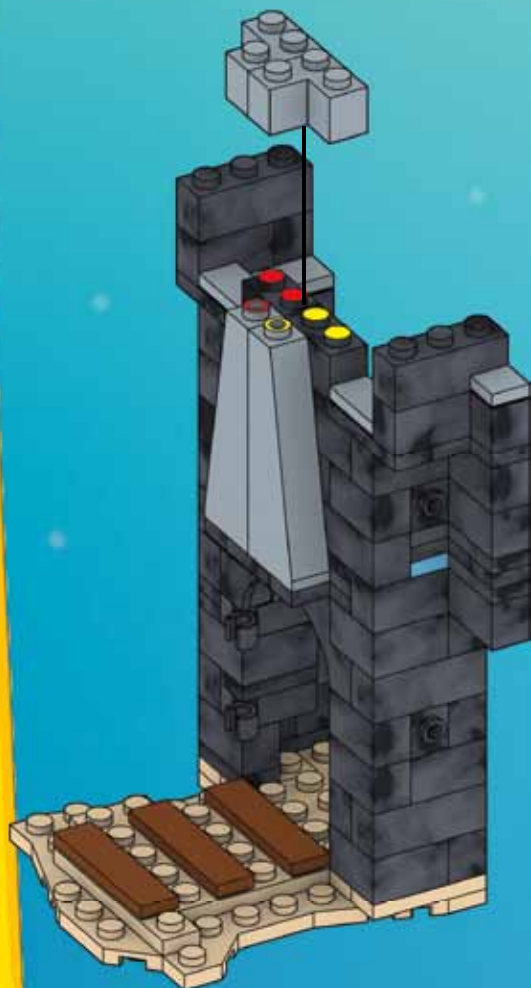

1

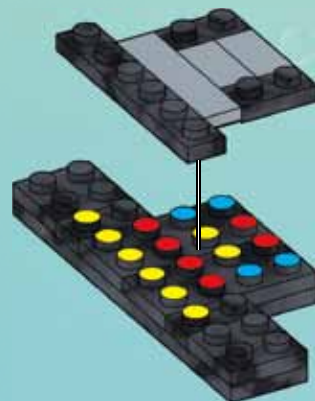

2

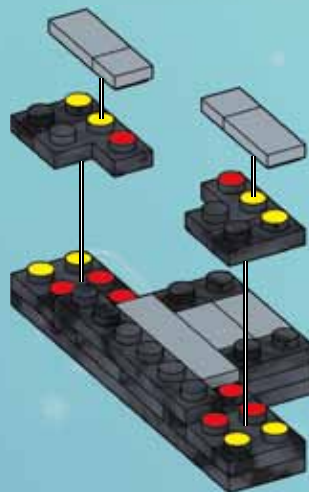

3



24



1x



2x

25



2x



2x

26



5x

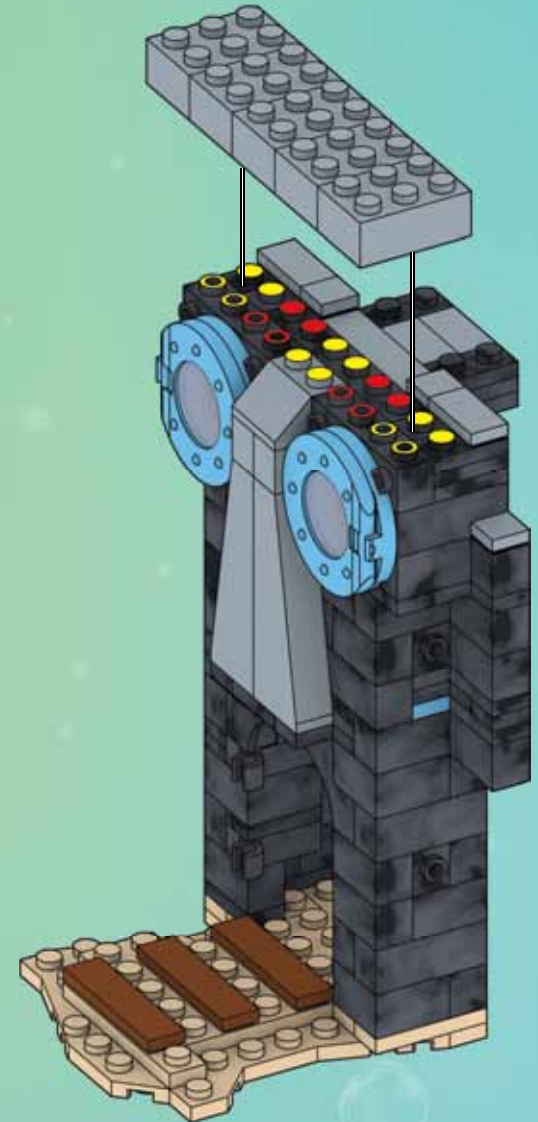
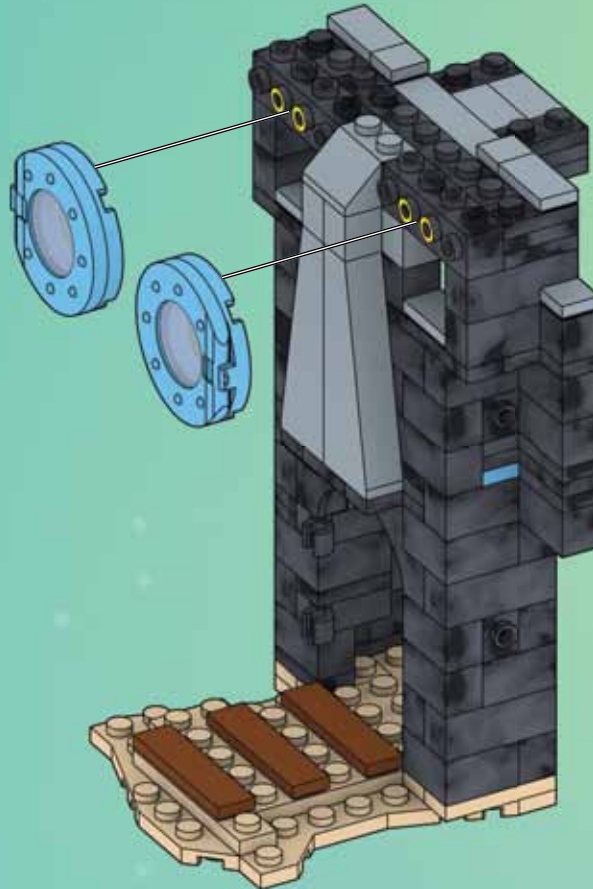
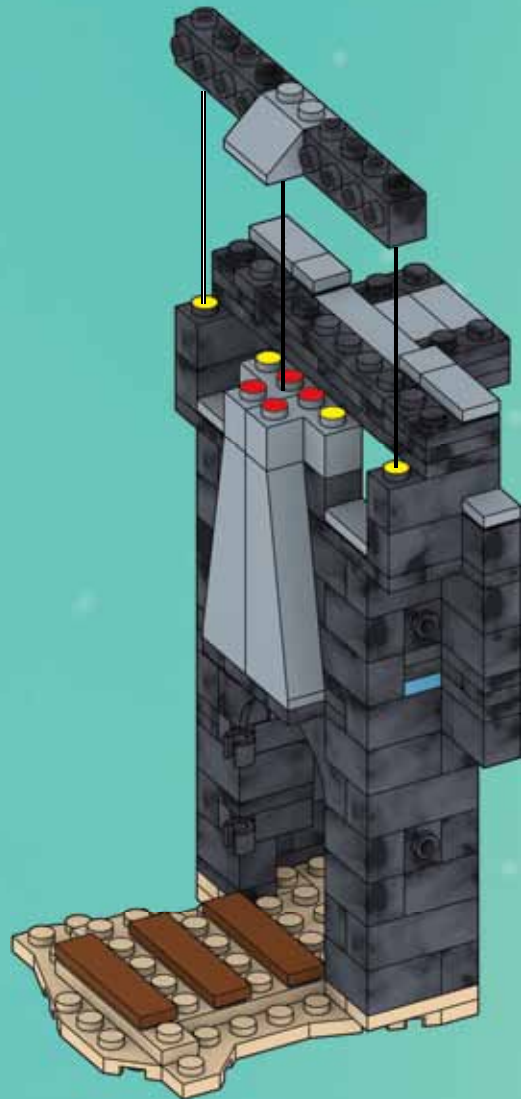
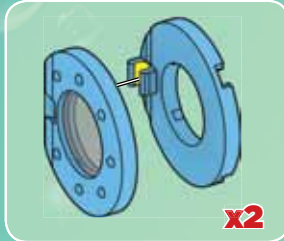

27

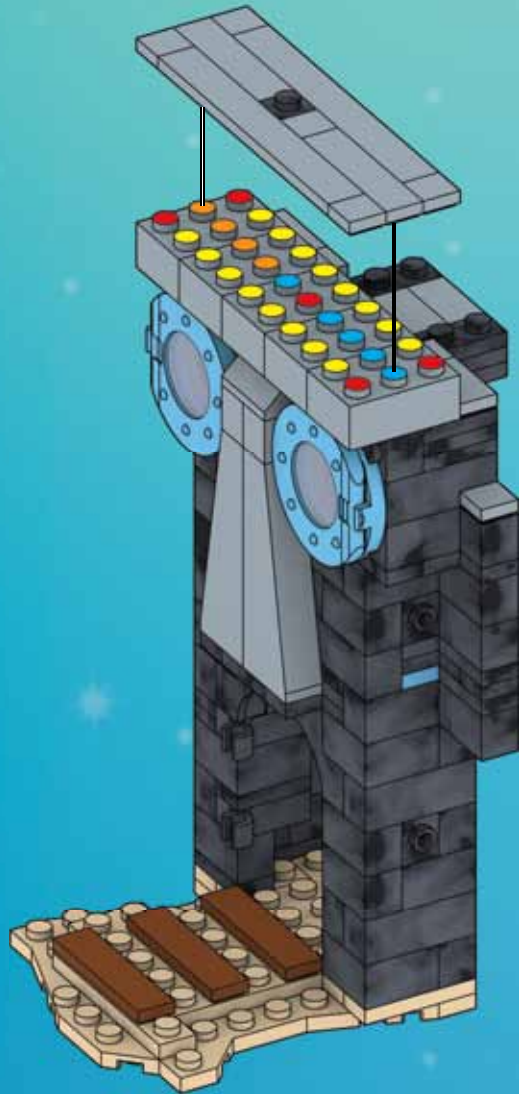
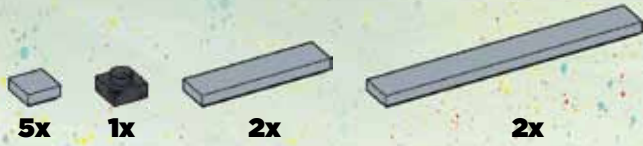

28

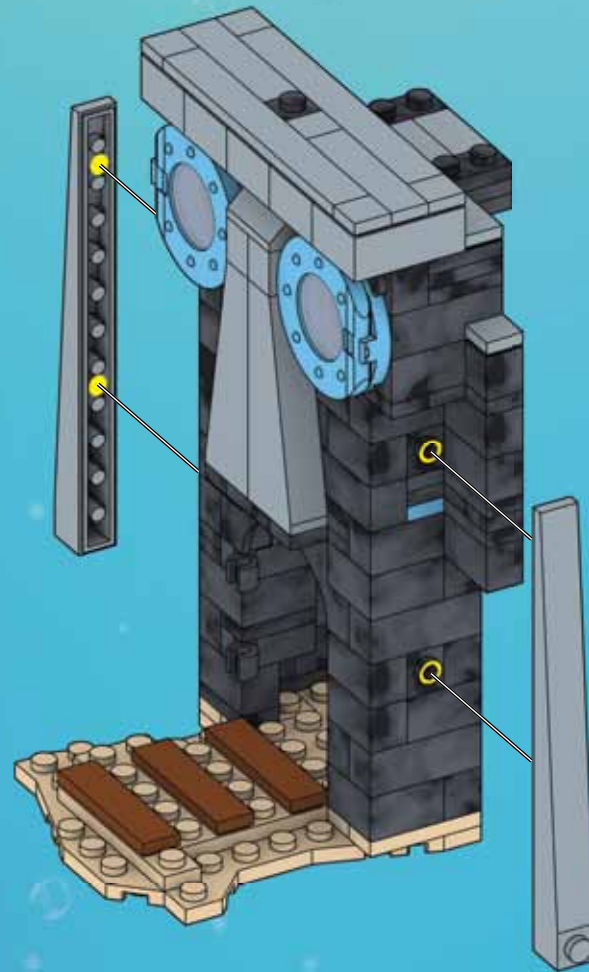
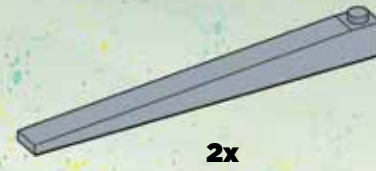

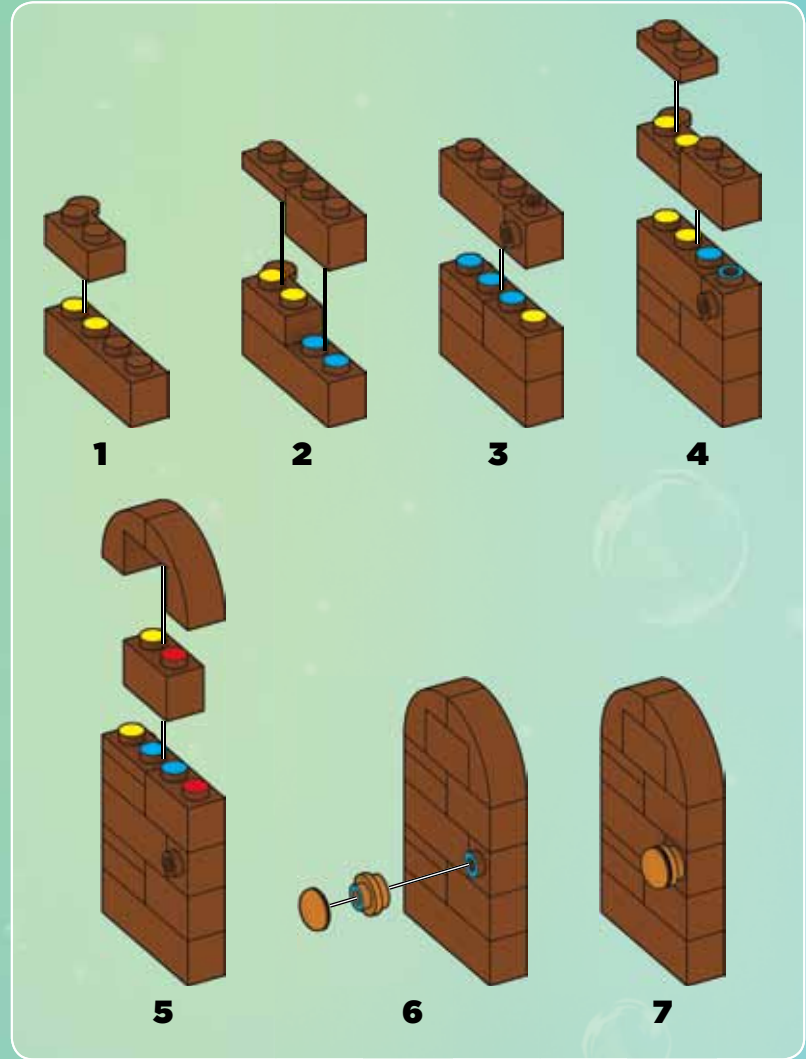
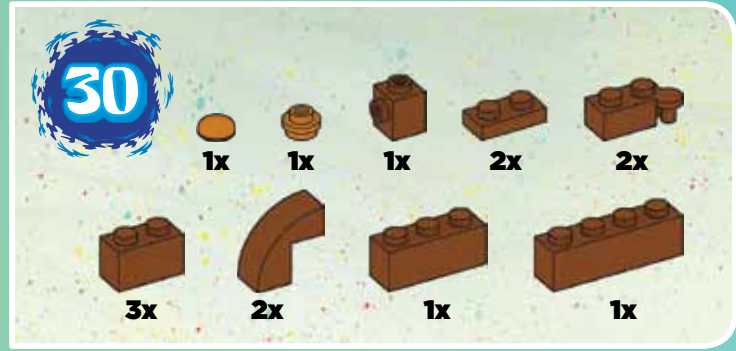
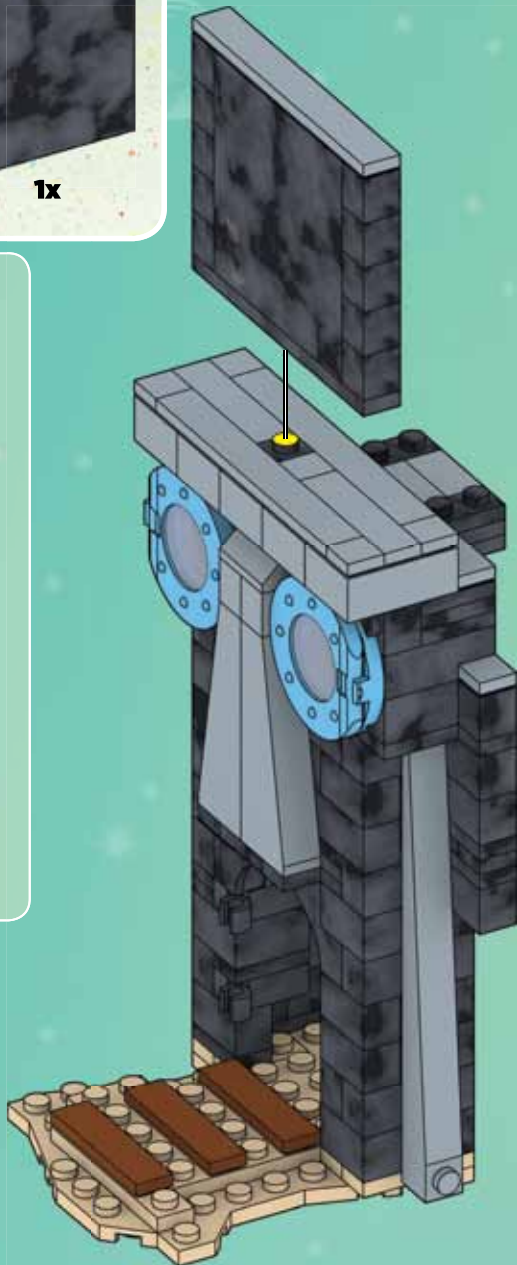
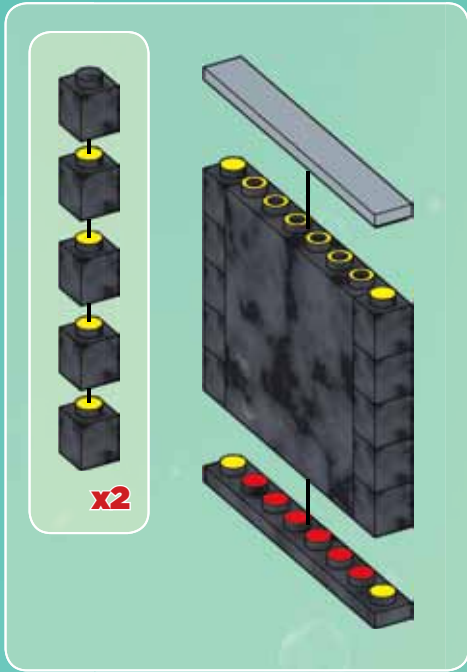
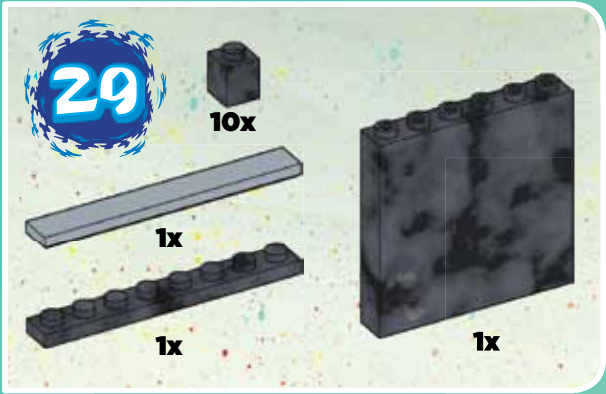



1

2

3

32

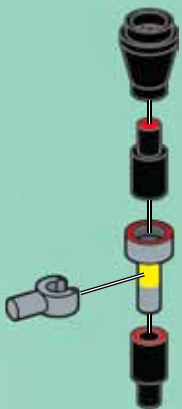

33

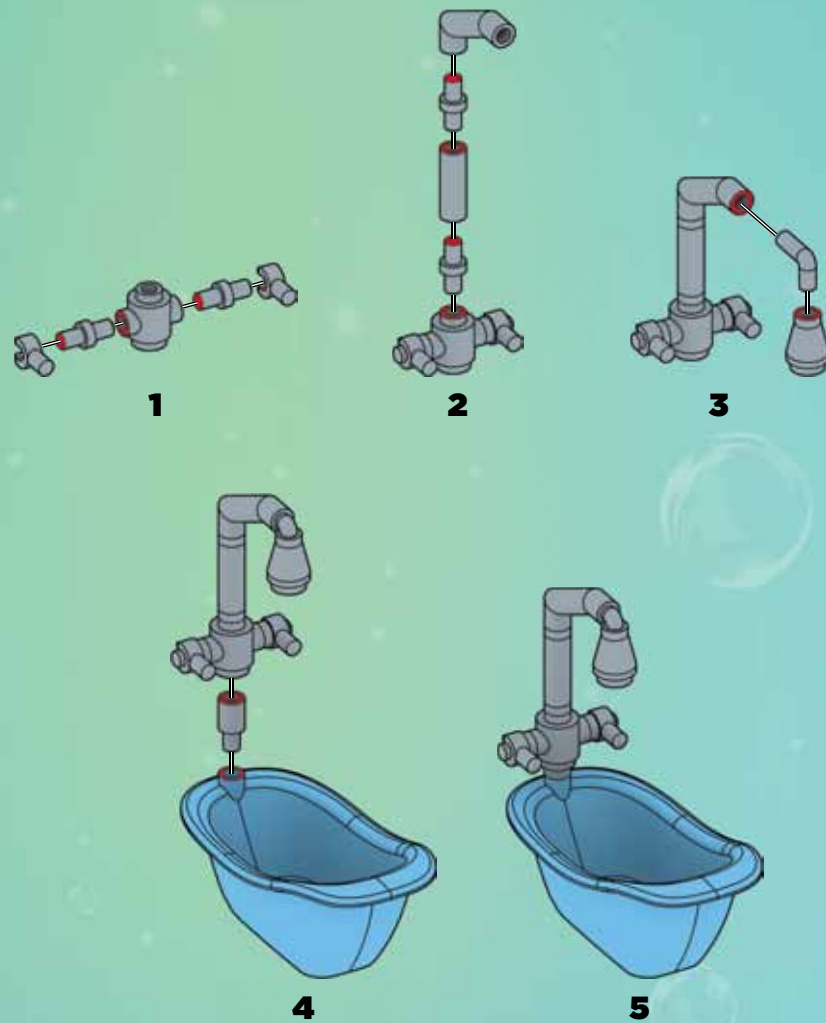
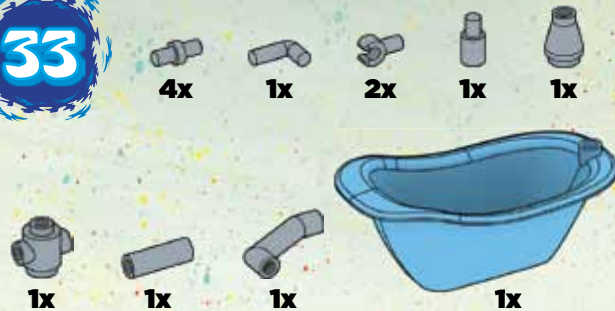

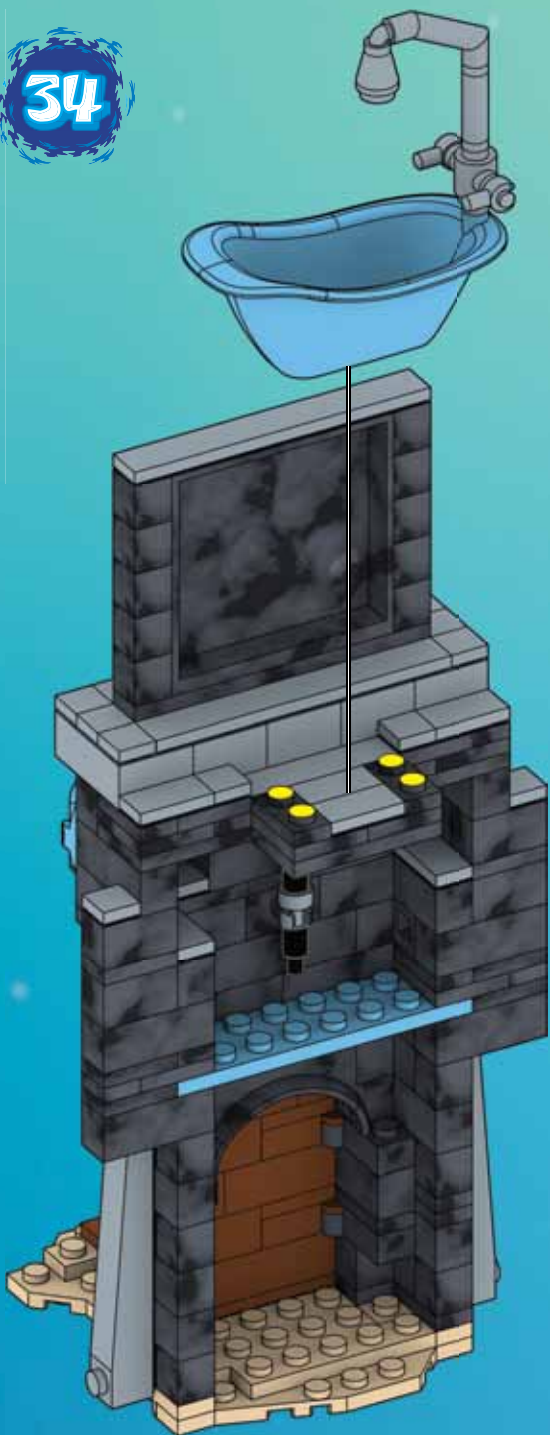

1



2

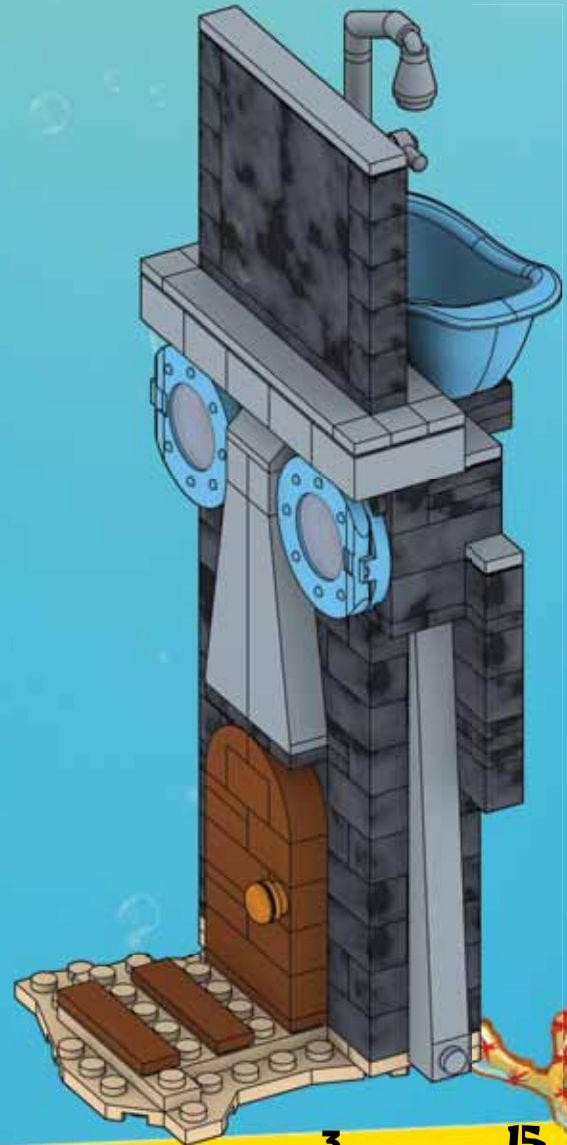

3

# SpongeBob SquarePants



\* Each sold separately and subject to availability. / Tous vendus séparément. Certains produits peuvent ne pas être commercialisés. / Se venden por separado y están sujetos a disponibilidad. / Vendidos em separado e sujeitos a disponibilidade. / Ognuno in vendita separatamente secondo disponibilità. / Alle Artikel separat erhältlich. Einige Artikel werden nicht in allen Ländern vertrieben. / Sprzedawane oddzielnie w zależności od dostępności. / Per stuk verkrijgbaar en niet overall leverbaar. / Каждый продукт продается отдельно, в зависимости от наличия. / Sælges separat og så længe lager haves. / Alla delar säljs separat så långt lagret räcker. / Hver leke selges separat så langt lageret rekker. / Jokainen myydään erikseen, saatavuus voi vaihdella. / Το καθένα πωλείται ξεχωριστά και ανάλογα με τη διαθεσιμότητα.

تباع كل منها على حدة وتخضع لتوفرها.  
 每件单独出售，并且视库存情况而定。/ それぞれ在庫状況に従って個別に販売されます。

You can collect them all! | À collectionner! | ¡Puedes coleccionarlos todos! | Colezione todos! | Collezionali tutti! | Du kannst sie alle sammeln! | Możesz zebrać je wszystkie!! | Verzamel ze allemaal! | Ты можешь собрать их всех!



\*CNF66



\*CNF63



\*CNF64



\*CNF67



\*CNH56



\*CNH49