



MEGA  
BLOKS

















# D E S T I N I Z I N G Y <sup>®</sup>





2x  AM75332KC  
 2x  AM75332MM  
 1x  AM18560AKM  
 2x  AM18560KC  
 14x  MA1113MM  
 2x  AM08417LP  
 12x  MA03328AWC  
 11x  MA03328AJK  
 1x  AS-DPJ13-06  
 4x  AM72001AJK  
 1x  AM17062AJJ  
 7x  MA17003MM  
 1x  AM19392AJD  
 1x  MA19392LP  
 4x  MA74397LP  
 2x  MA74397AWC  
 2x  AM19158KC  
 1x  AM72244AWC  
 2x  AM18592LP  
 2x  AM76060LP  
 2x  AM76060AWC

2x  AM19650LP  
 5x  MA1312MM  
 1x  MA1140LP  
 2x  M1140KC  
 4x  AM08841LP  
 6x  AM74415AJK  
 2x  AM74415MM  
 2x  AM74415KC  
 2x  AM18240AKM  
 1x  AM08412DH  
 12x  MA0910AWC  
 1x  AM02172AWC  
 4x  MA07659AJK  
 2x  MA07659AKM  
 1x  MA07629AKM  
 12x  AM17018MM  
 2x  MA04428AJK

1x  AS-DPJ13-10  
 1x  AM18260LP  
 2x  AM17506AJD  
 3x  MA17506LP  
 2x  AM73534BDG  
 3x  AM18287AJD  
 2x  MA17201AJK  
 2x  MA16649AWC  
 6x  M022501KC  
 4x  MA022501AJK  
 15x  MA09393AJK  
 2x  M09393KC  
 30x  MA09393AWC  
 2x  MA18901AJK  
 1x  M18549KC  
 4x  M03019KC

2x  AM76467AJK  
 12x  AM76467AWC  
 6x  MA15480MM  
 6x  MA15481MM  
 12x  AM18740AWC  
 2x  AM18740AJK  
 4x  MA72002AJK  
 4x  MA17522AJK  
 12x  MA17522AWC  
 3x  MA17788AJK  
 2x  AM16843AJK  
 2x  MA17128AJK  
 6x  AM18272AWC  
 1x  MA16679AJK  
 1x  MA04429AJK  
 2x  MA1322AJK  
 6x  MA1417AJK

1x  MA72000LP  
 2x  MA72000AJK  
 1x  AM73009LP  
 2x  AM18014AJK  
 2x  MA07658AJK  
 3x  MA07658LP  
 1x  AM72014AWC  
 7x  MA09013AJK  
 2x  MA17502AJK  
 1x  AM02215LP  
 2x  AM01748LP  
 1x  AM19646LP  
 3x  AM19380LP  
 2x  AM17010KC  
 2x  AM17010AKM

1x  AM18266LP  
 1x  AM18266AWC  
 1x  AM19647LP  
 4x  MA1320AJK  
 7x  AM72249LP  
 2x  AM76653MM  
 6x  MA16975LP  
 4x  MA16954AJK  
 1x  AM18255AWC  
 1x  AM18256AJD  
 4x  MA15484AJK  
 3x  MA1146LP  
 6x  MA03773AJK  
 13x  MA03773LP  
 1x  MA18223LP

6x  AM73233AWC  
 1x  AM15514AJK  
 1x  AM72442MM  
 1x  AM74106KC  
 1x  AM74106LP  
 5x  AM74106AJK  
 3x  AM74106AWC  
 2x  AM04321AJK  
 4x  MA10273AJK  
 2x  MA1154AJK  
 2x  MA09023AJK  
 6x  MA17153AJK  
 2x  AM75561AJK  
 2x  AM75562AJK

- 2x MA18328AJK
- 3x MA18329AJK
- 1x AM19199AJK
- 1x AM19199AKM
- 7x AM19199LP
- 1x AS-DPJ13-09
- 1x AM19012AJK
- 18x AM73224LP
- 18x AM73223LP
- 6x AM73228LP
- 2x AM17869AWC
- 3x AM19775AWC
- 2x MA02212AJK

- 2x AM08481AJK
- 12x AM74103AJK
- 4x MA1314AJK
- 1x AM72600AKM
- 4x MA07230AJK
- 1x AM17509AJK
- 4x MA03772AJK
- 7x MA03772LP
- 4x MA16384AJK
- 2x AM72240AWC
- 6x AM18902DH
- 6x AM74977LP
- 2x MA1139AJK
- 2x AM19324AJK

- 1x AM18282AJK
- 1x AM18283AJK
- 2x AM15478AJK
- 2x AM15479AJK
- 2x AM17056AJK
- 2x MA18279AJK
- 2x M09593KC
- 9x MA09593AJK
- 4x AM19323AJK
- 2x MA17503AJK
- 12x AM73390AWC
- 6x AM73003AJK
- 2x AM18299AWC
- 4x MA09493AJK

- 2x MA09033AJK
- 1x AS-DPH83-85
- 6x AS-DPJ13-07
- 6x AM19016AJK
- 2x AM19781AJK
- 1x AM77121AJD
- 1x AM72013MM
- 1x AM77738AGY
- 1x AM18524AGY
- 3x AM77792AUK
- 1x MA18281AJK
- 1x MA18280AJK

- 2x AM18656AJK
- 7x MA09292AJK
- 2x MA1313AJK
- 2x MA17055AJK
- 1x MA18298AJK
- 2x AM18259AJD
- 1x AM76192AGY
- 1x AM18783AJK
- 1x AM76561AJK
- 1x AS-DPJ13-05
- 1x MA74678AJK

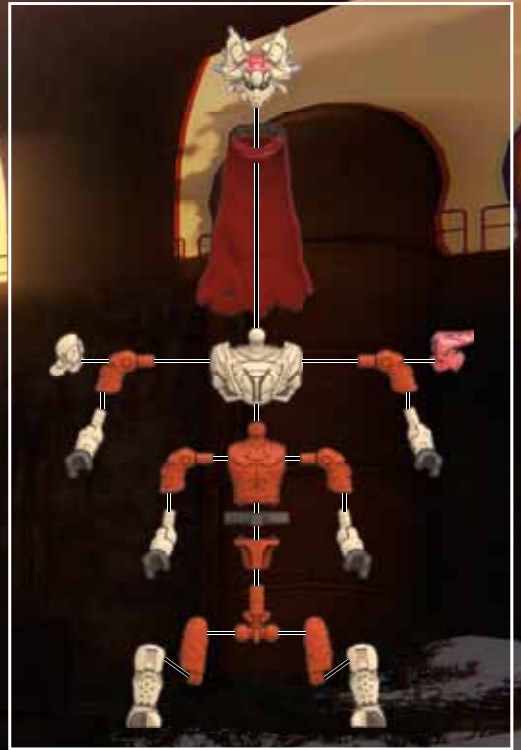
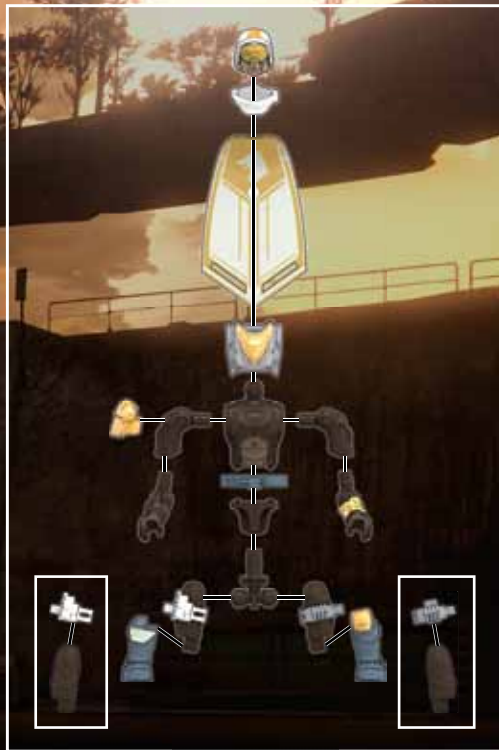
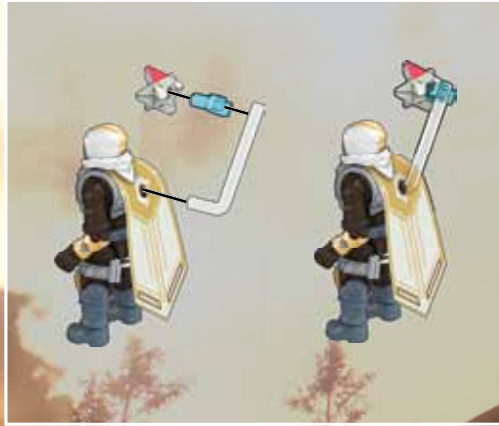
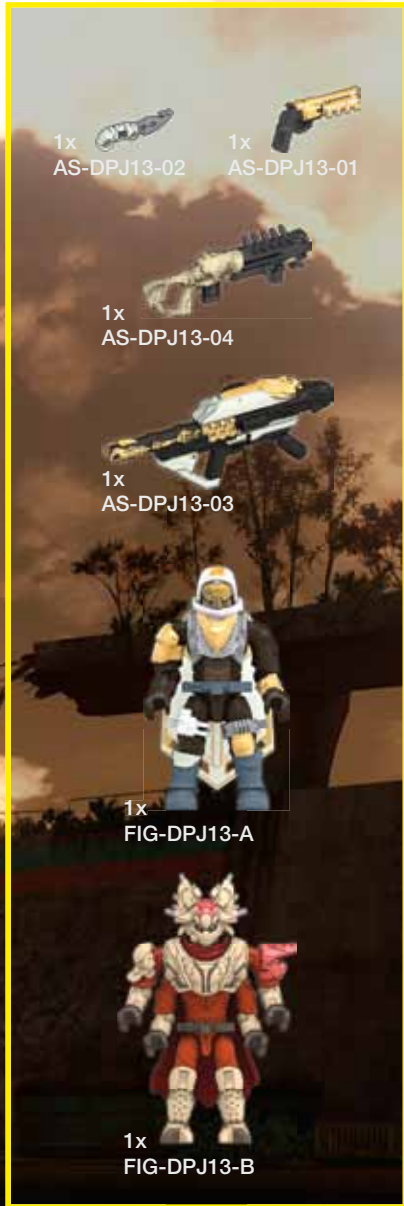

© D714,887 / Patent Pending

Please read these instructions carefully before first use and keep them for future reference.  
 Il est recommandé de lire attentivement ce feuillet avant la première utilisation et de le conserver pour référence future.  
 Leer estas instrucciones cuidadosamente antes de la primera utilización y guardarlas para referencia futura.  
 Leia as instruções antes do primeiro uso e guarde-as para futura referência.  
 Leggere le istruzioni prima di cominciare ad usare il gioco e conservarle per reference future.  
 Die Gebrauchsanleitung bitte durchlesen und aufbewahren.

Proszę uważnie przeczytać instrukcję obsługi przed pierwszym użyciem, a następnie zachować ją na przyszłość.  
 Wij raden u aan deze handleiding zorgvuldig te lezen en te bewaren voor eventuele raadpleging op een later tijdstip.  
 Внимательно прочитайте инструкцию перед первым использованием и сохраните ее для дальнейшего использования.  
 Vær venlig at læse disse instruktioner omhyggeligt inden ibrugtagen og opbevar dem til fremtidigt brug.  
 Läs noggrant igenom dessa instruktioner innan du använder produkten för första gången och spara dem för ev. framtida frågor.  
 Les disse instruksjonene nøye før første gangs bruk, og ta vare på dem for fremtidige oppslag.  
 Lue nämä ohjeet huolellisesti ennen ensimmäistä käyttöä ja säilytä ne myöhempää tarvetta varten.

Διαβάστε αυτές τις οδηγίες προσεκτικά πριν χρησιμοποιήσετε το προϊόν για πρώτη φορά και φυλάξτε τις για μελλοντική αναφορά.  
 يرجى قراءة هذه التعليمات بدقة قبل البدء بالاستعمال والاحتفاظ بها كمرجع للمستقبل.  
 请在初次使用前仔细阅读这些指示，并保留它们以便未来参考。  
 初めてご使用になる前に、この説明書をよくお読みください。また、本書は将来いつでも参照できるように保管してください。



BUNGIE

DESTINY © BUNGIE, INC. DESTINY IS A REGISTERED TRADEMARK OF BUNGIE, INC. ALL RIGHTS RESERVED. GAME PUBLISHED AND DISTRIBUTED BY ACTIVISION.

DESTINY.MEGABLOKS.COM



- 1
- 1x [Red 1/2 Pin]
  - 3x [Grey Technic Axle]
  - 1x [Brown 1x3 Technic Brick]
  - 1x [Red 1x2 Technic Brick]
  - 2x [Red 1/2 Round Technic Plate]
  - 1x [Red 1x3 Technic Brick]



1

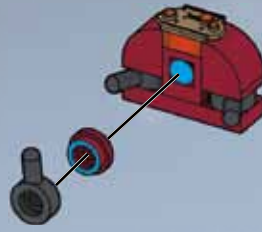

2



3

- 2
- 2x [Grey Technic Axle]
  - 2x [Grey Technic Axle]
  - 2x [Grey Technic Axle]
  - 2x [Grey Technic Axle]
  - 2x [Red 1/2 Round Technic Plate]
  - 2x [Red 1/2 Round Technic Plate]
  - 1x [Red 1/2 Round Technic Plate]

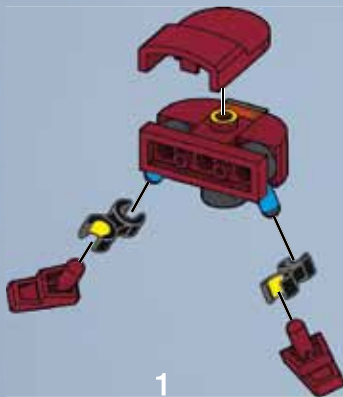

1

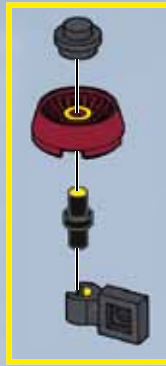

2

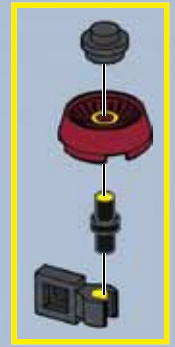
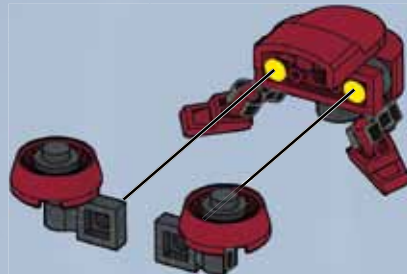

- 3
- 1x [White Technic Pin]
  - 1x [Grey 1x3 Technic Brick]

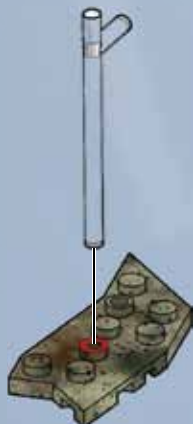

1



2



3



1

2x      2x      1x

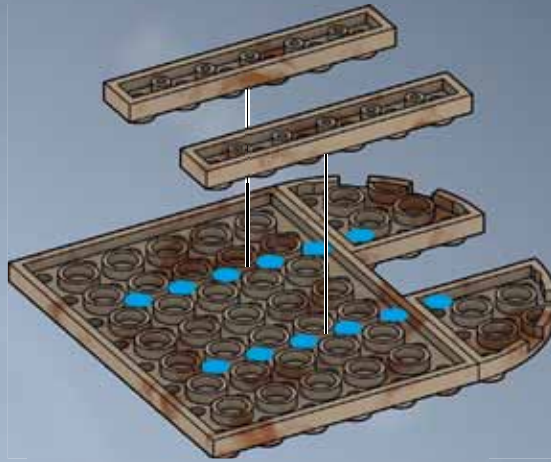

2

3x      1x      1x      1x      1x

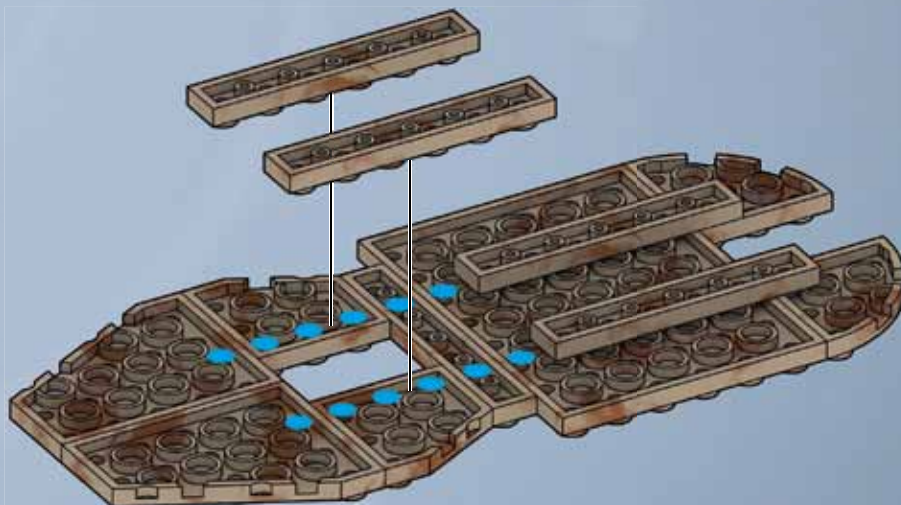

3  
6x

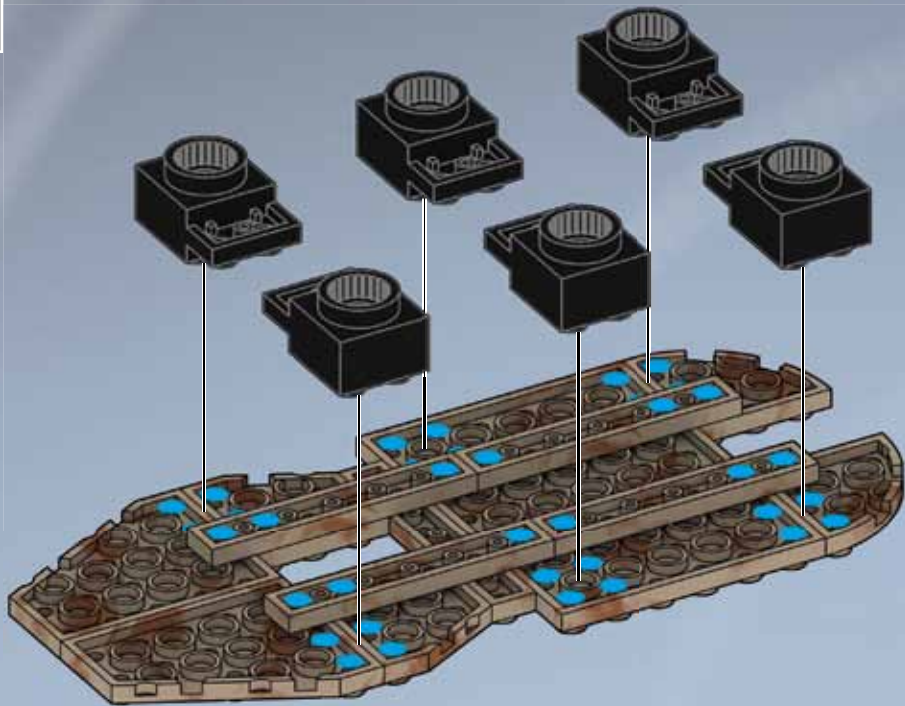

4

2x      2x      2x      2x

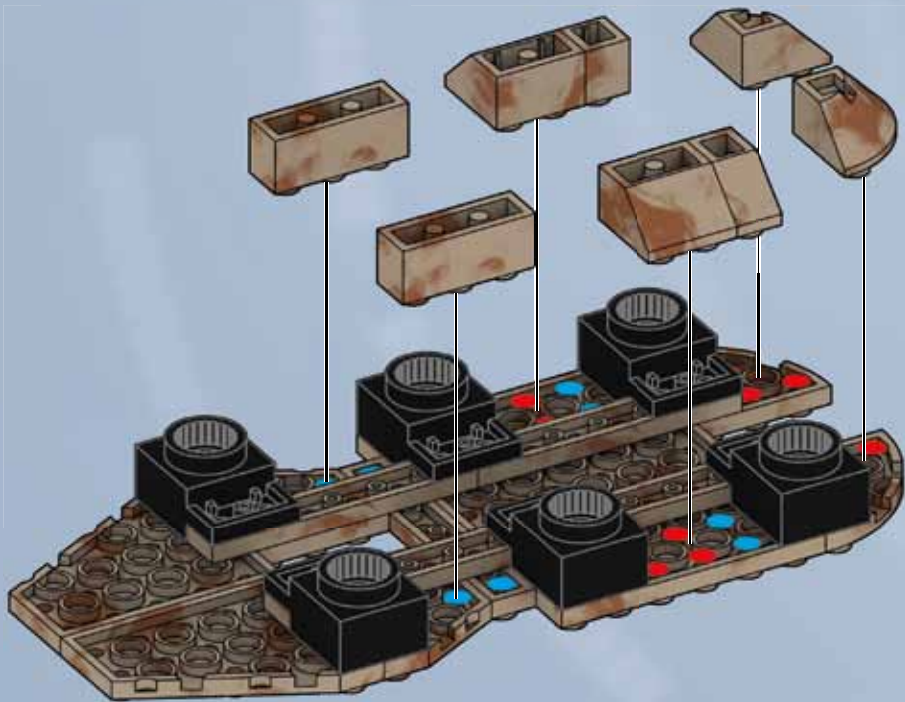





5



2x



1x



1x

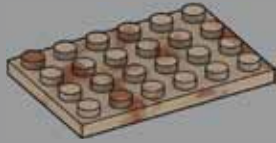

2x

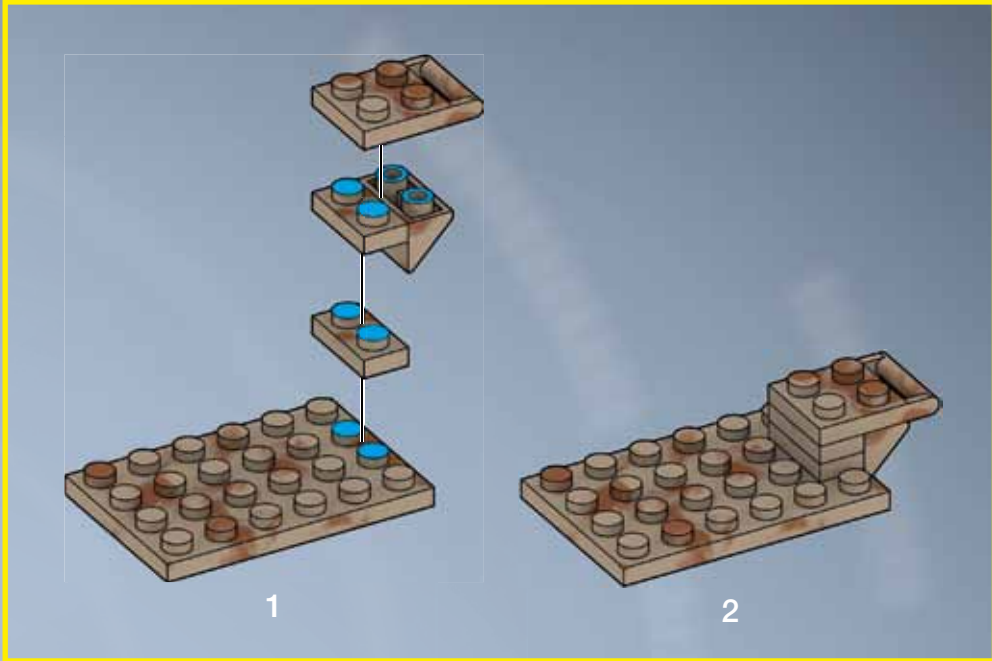

1

2

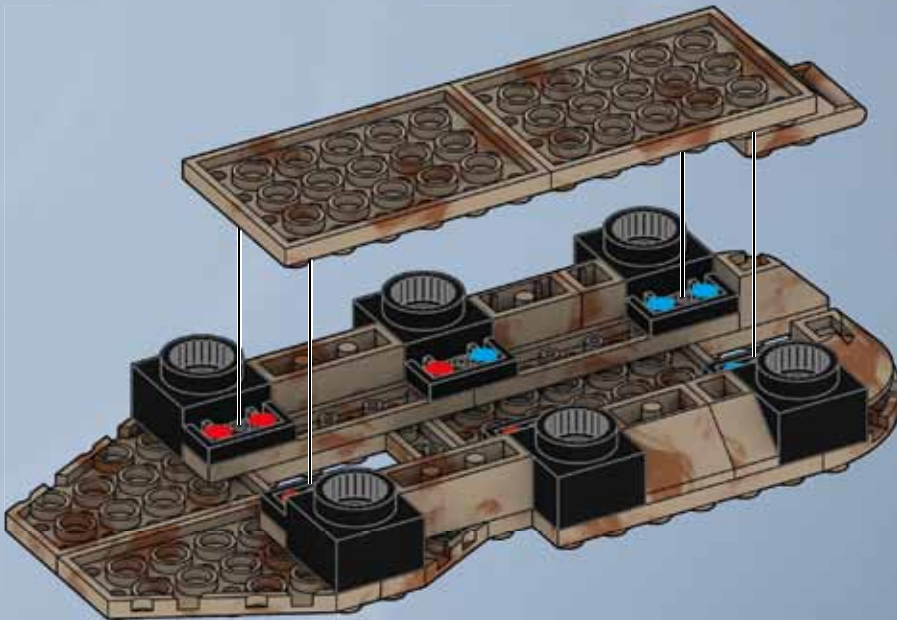

6



1x



3x

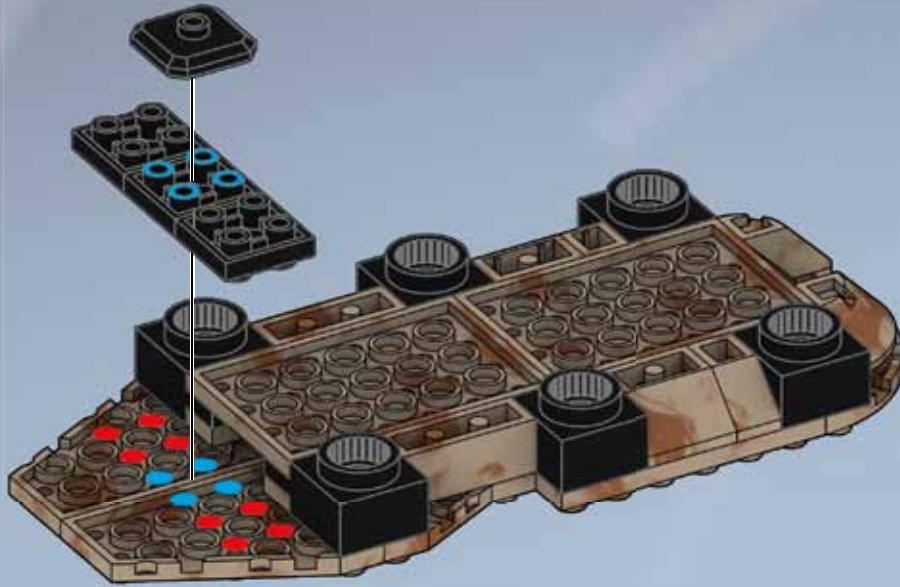

1

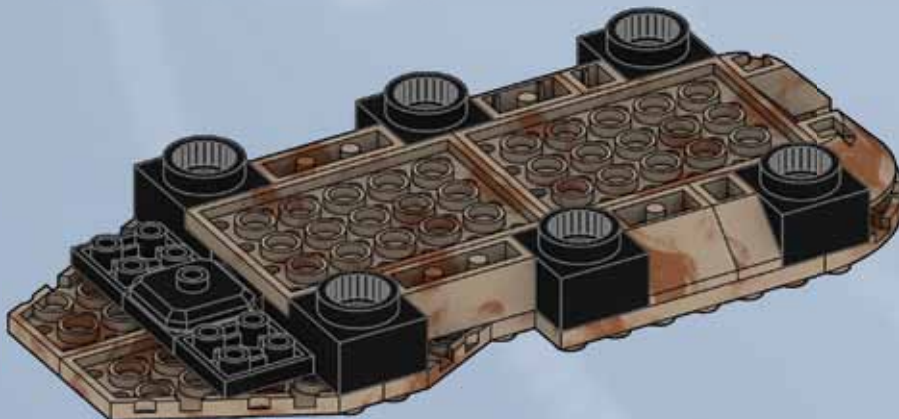

2



7

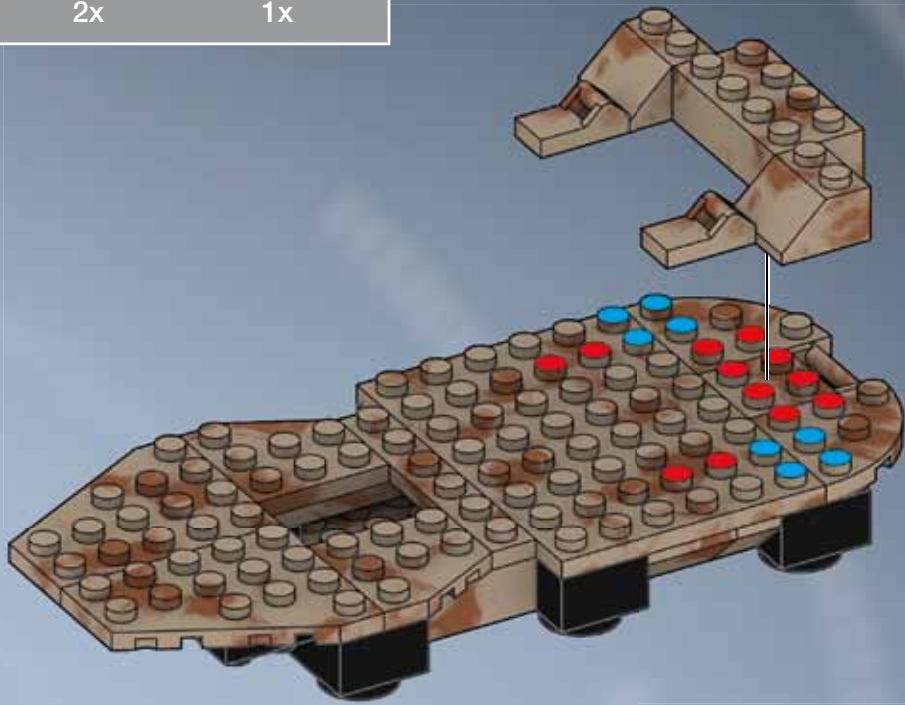

8

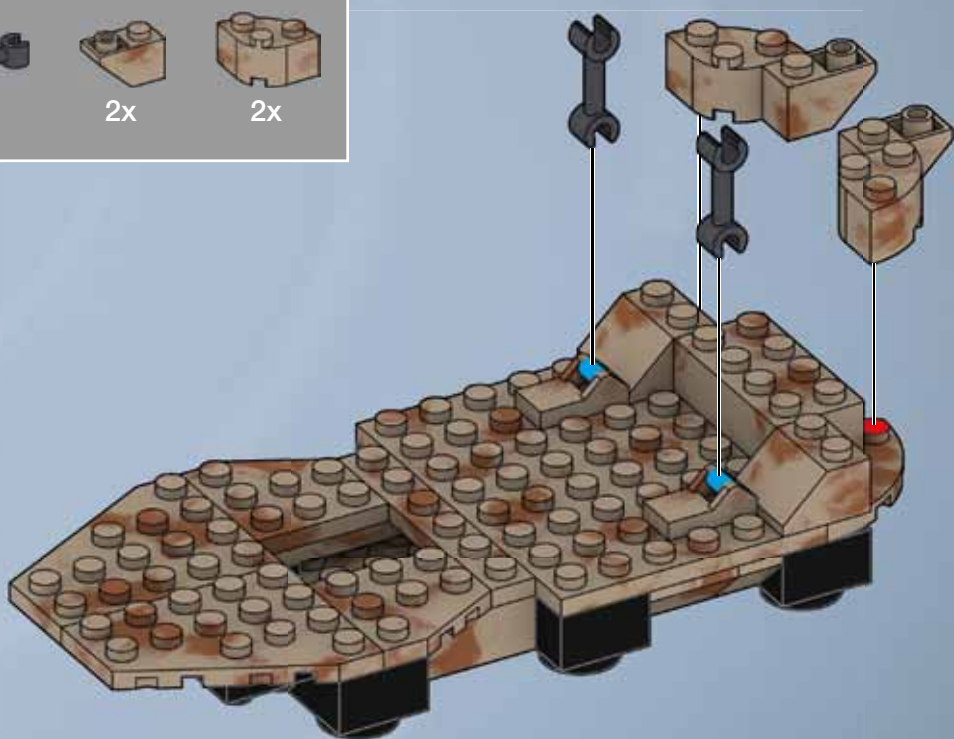

9  
4x

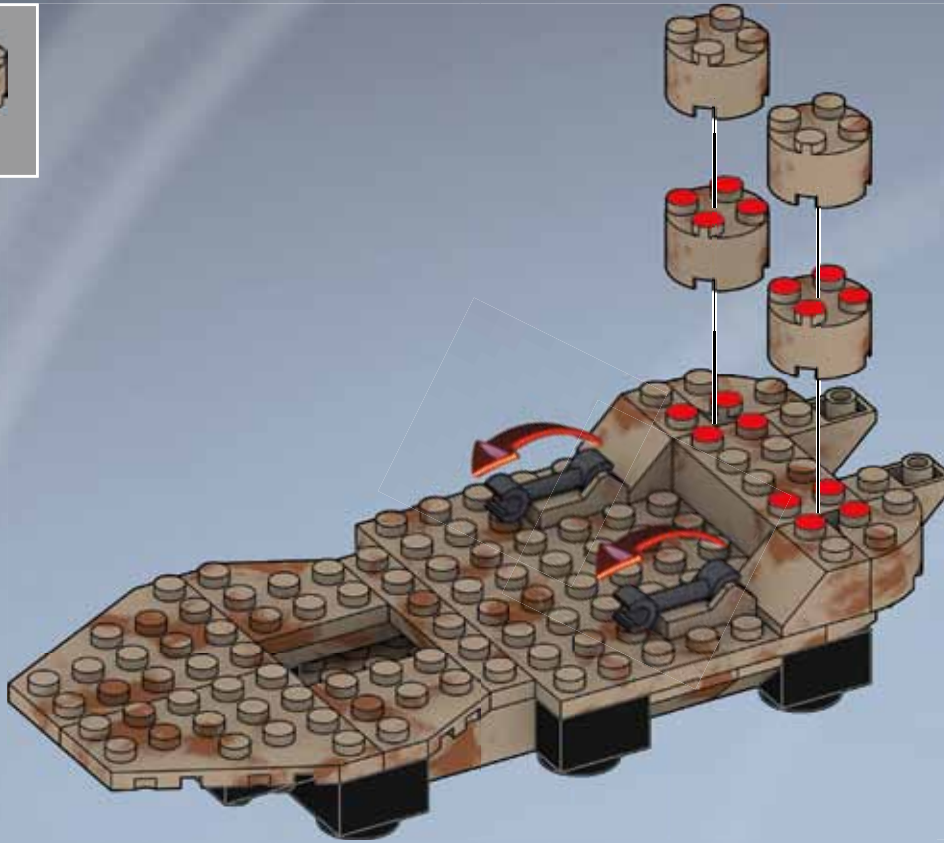

10  
4x







11

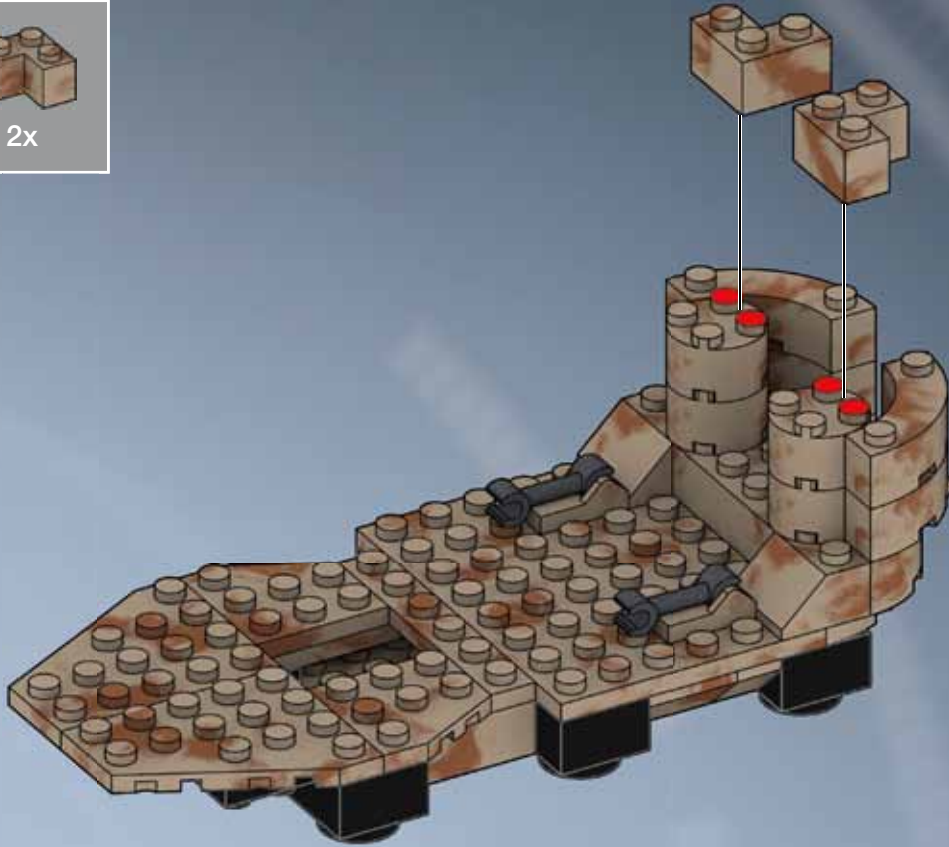

2x



12



1x



1x



2x

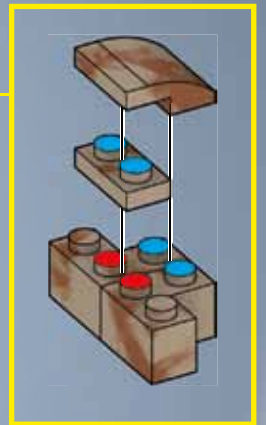

13



2x

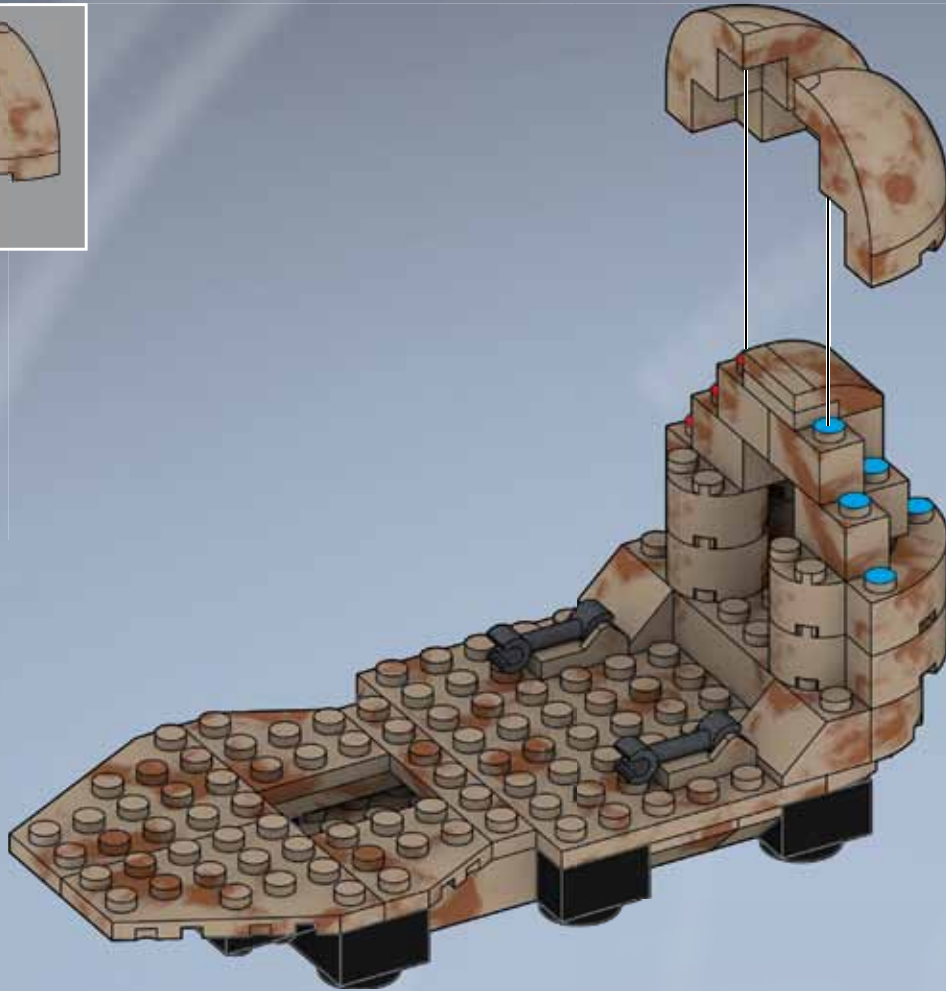

14



1x



1x



2x



1x



1x



1x



1x



1x



1x

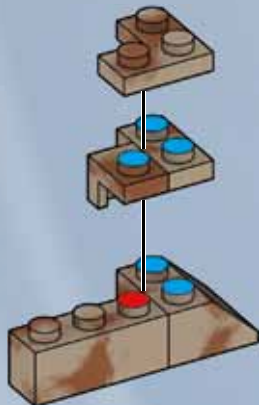

1



2

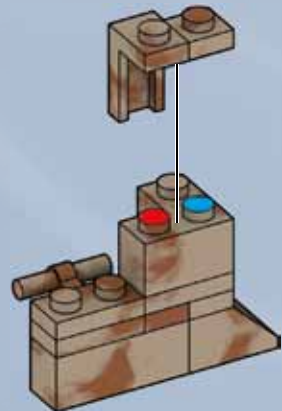

3



15

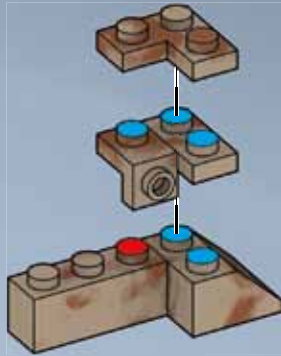
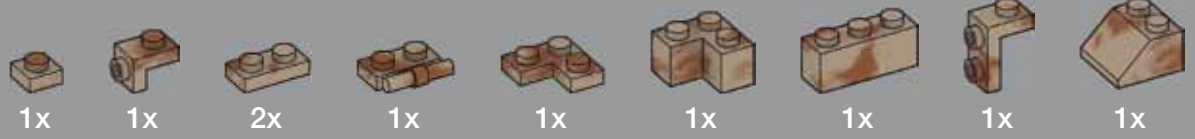

1



2

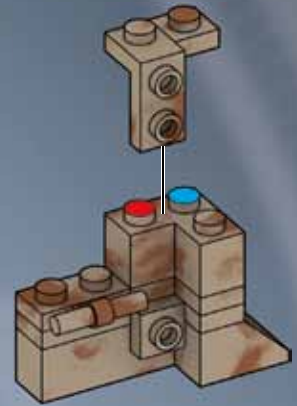

3

16



2x

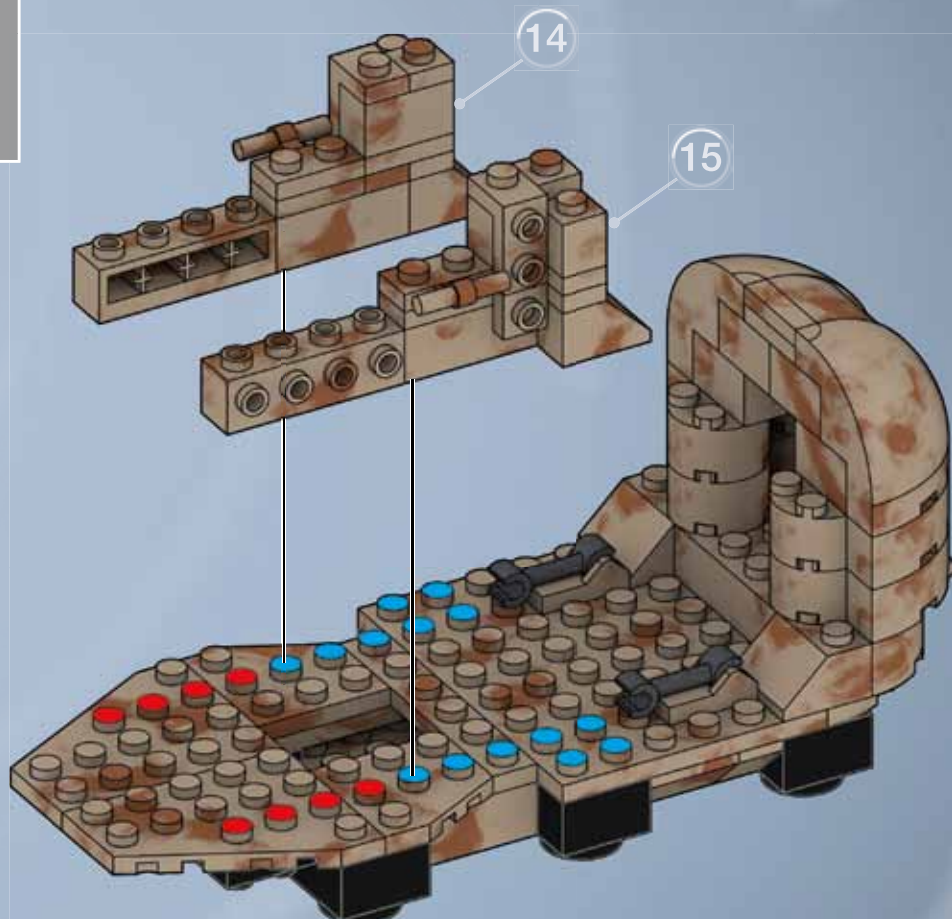

17



2x

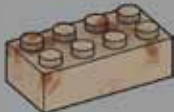

1x

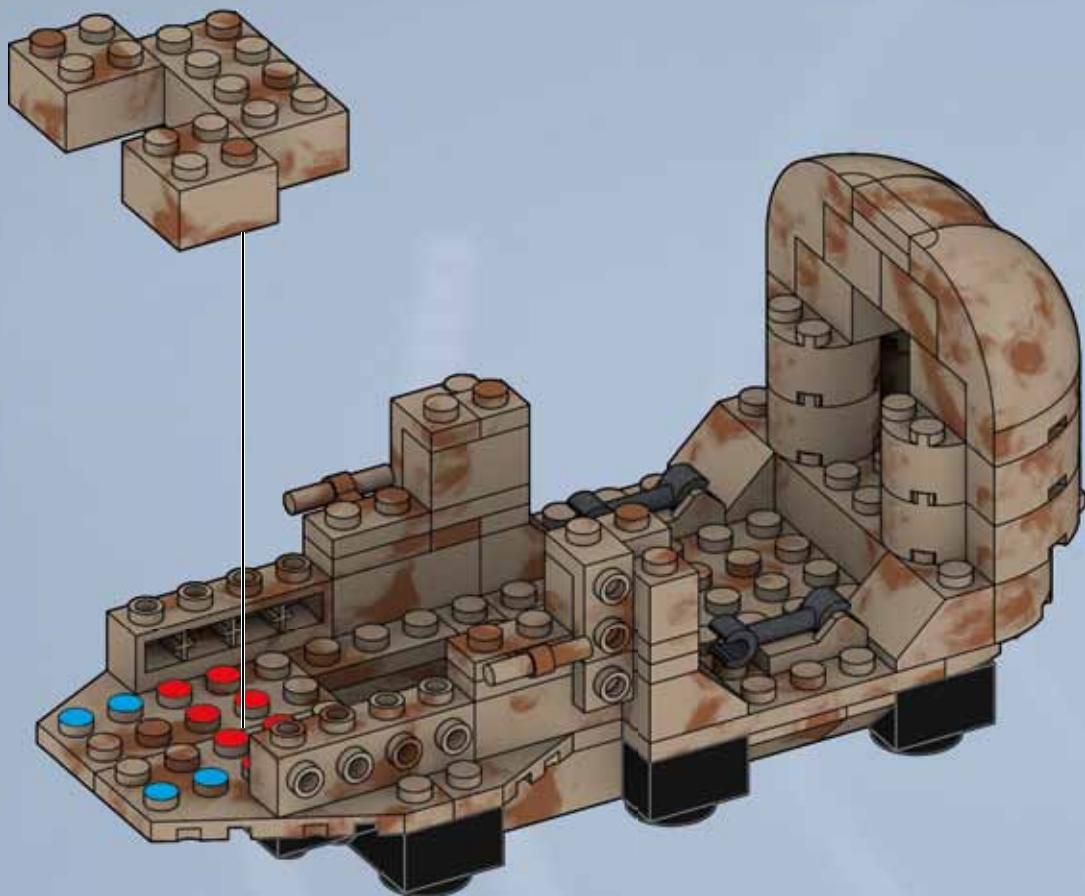





18

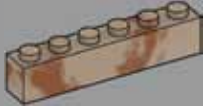

2x

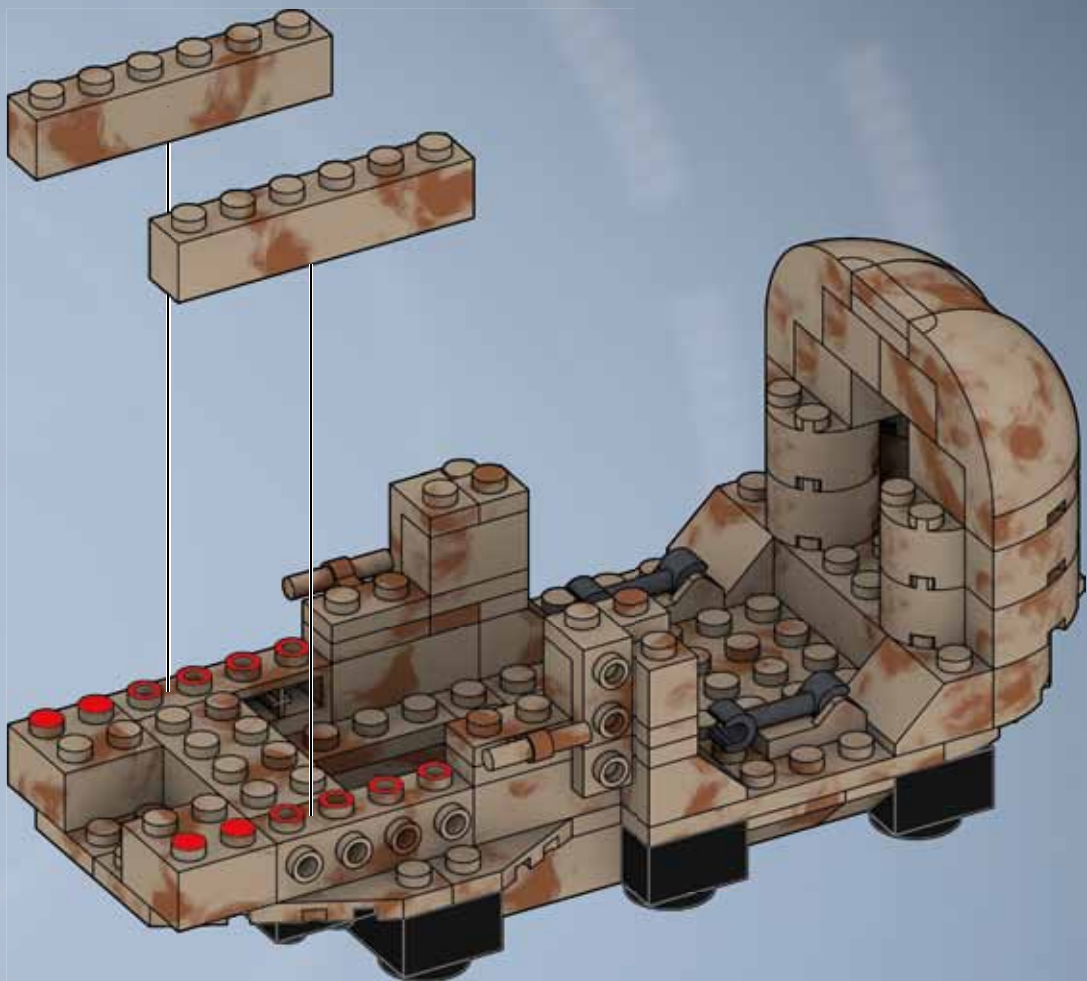

19



2x



2x

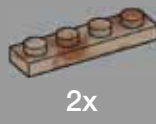

2x



1x

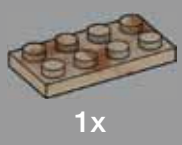

1x

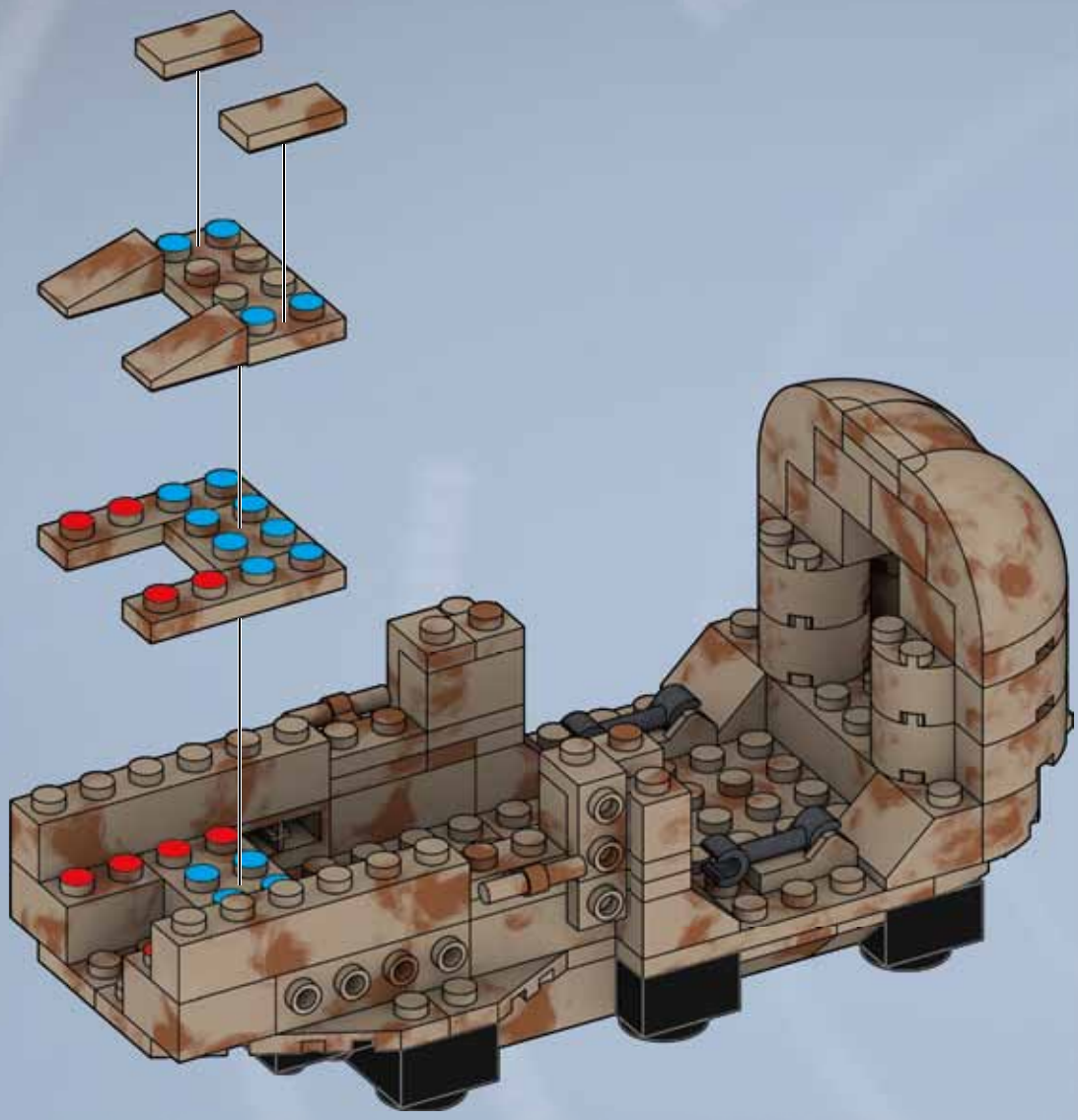



20

4x

2x

2x

2x

2x

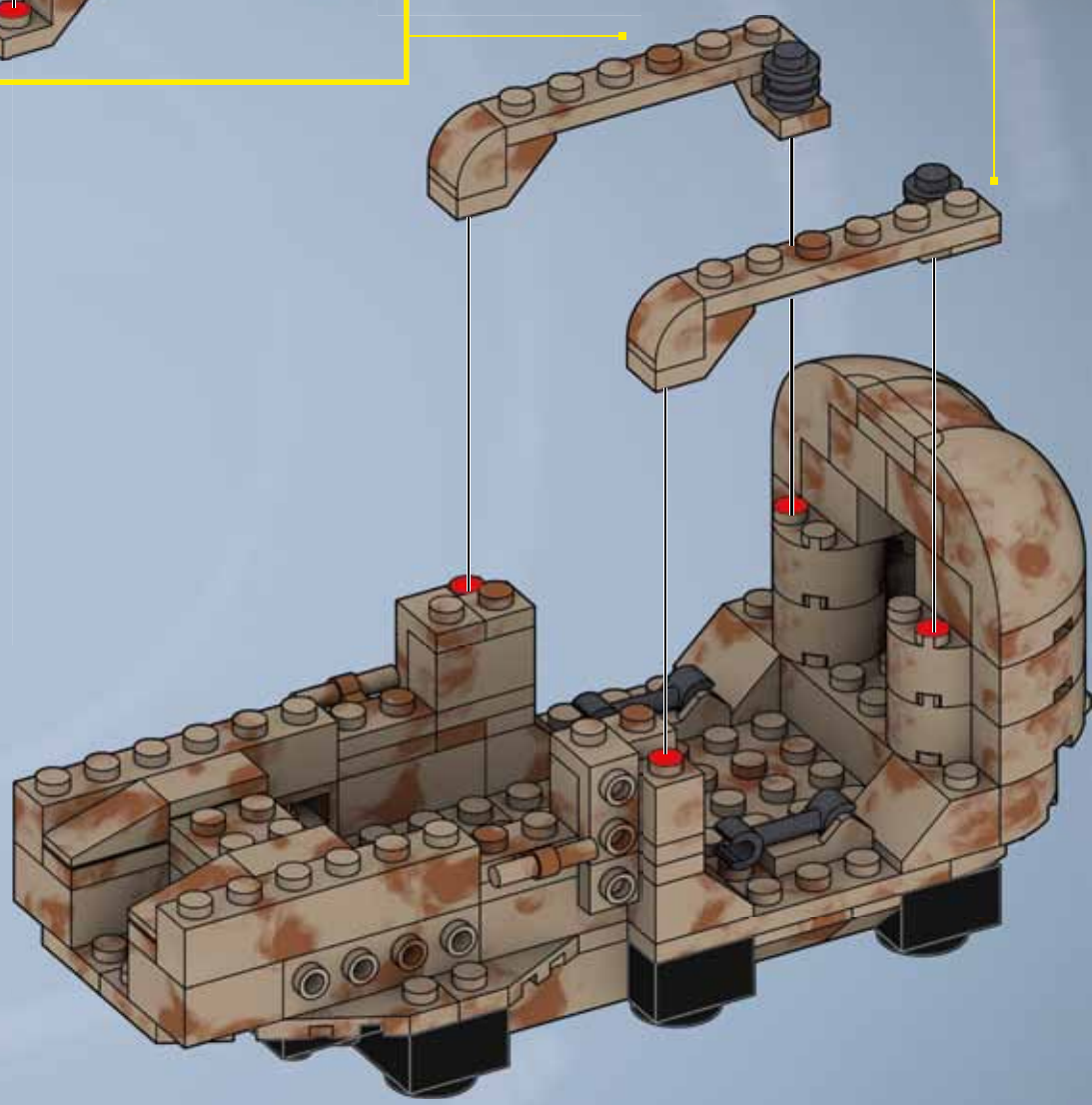
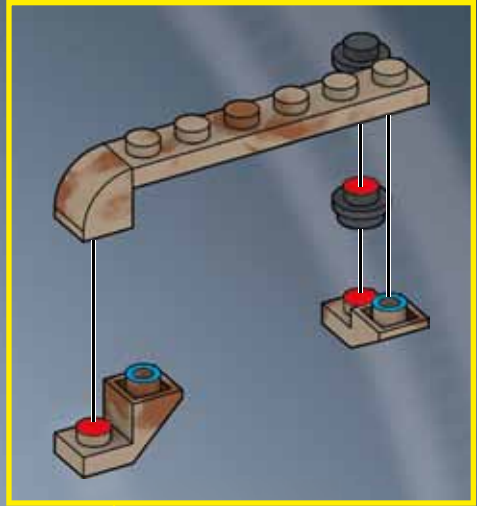
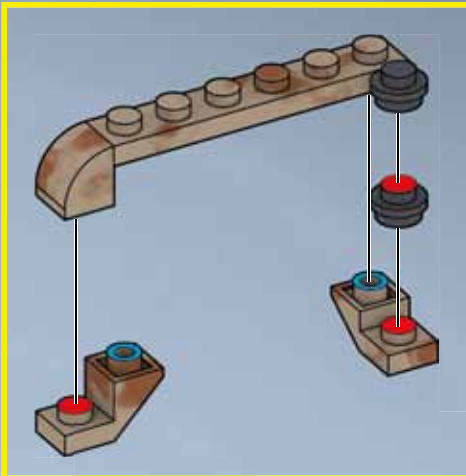

21



2x

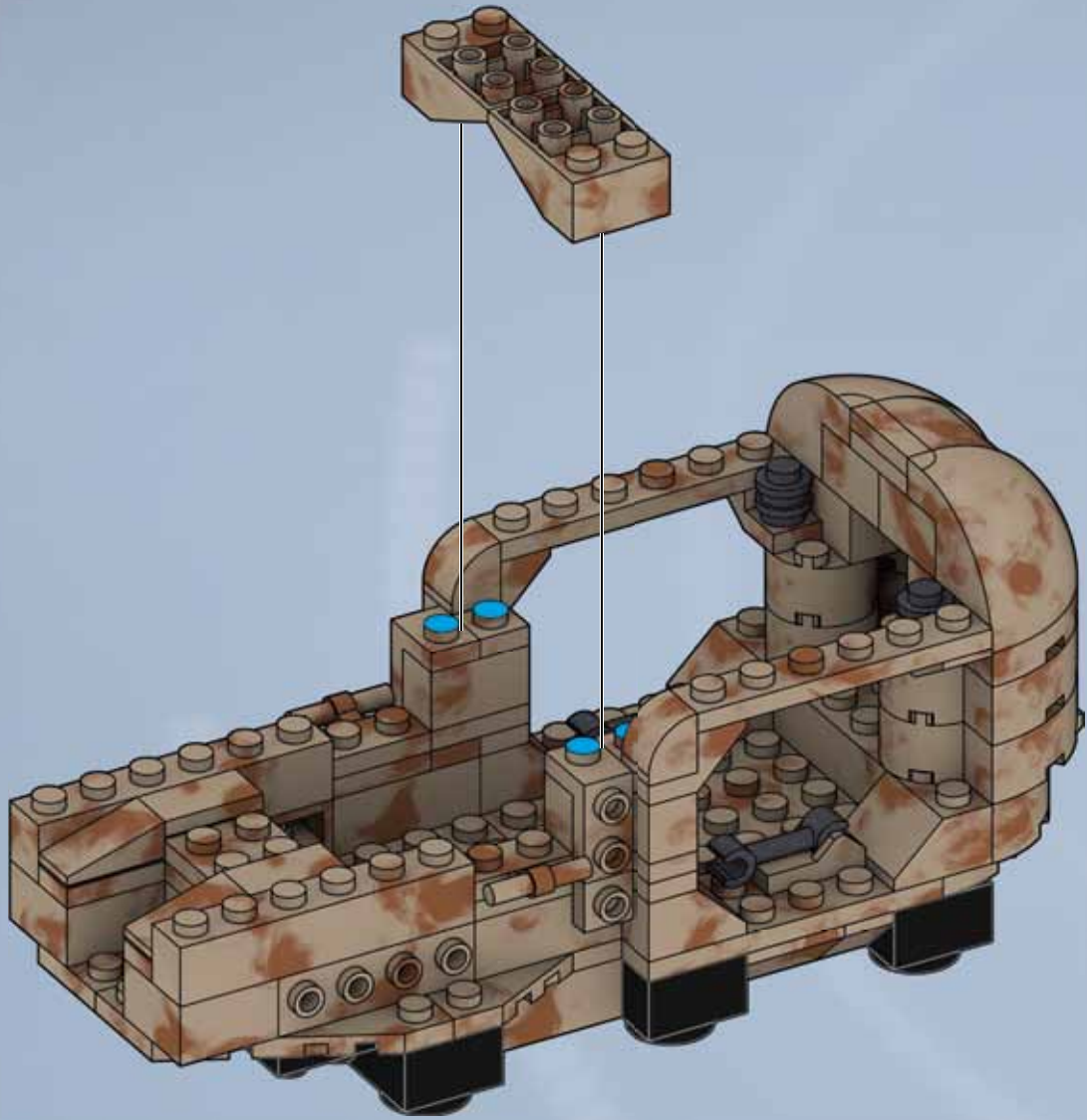



22



2x

2x

1x

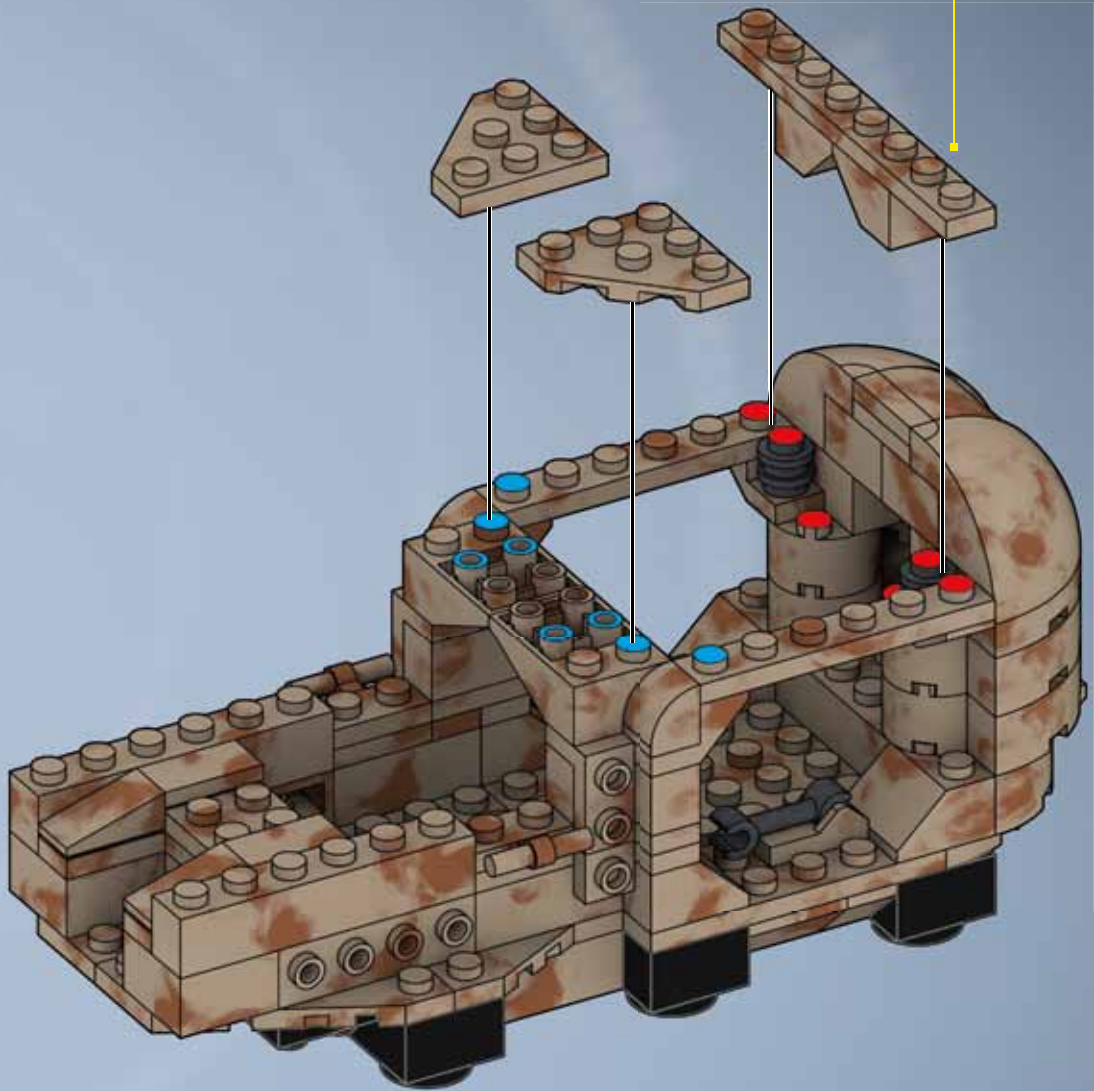
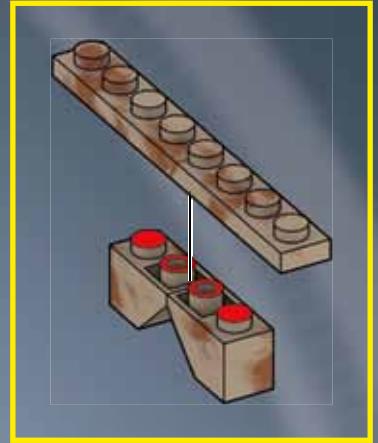

23



2x



2x



2x

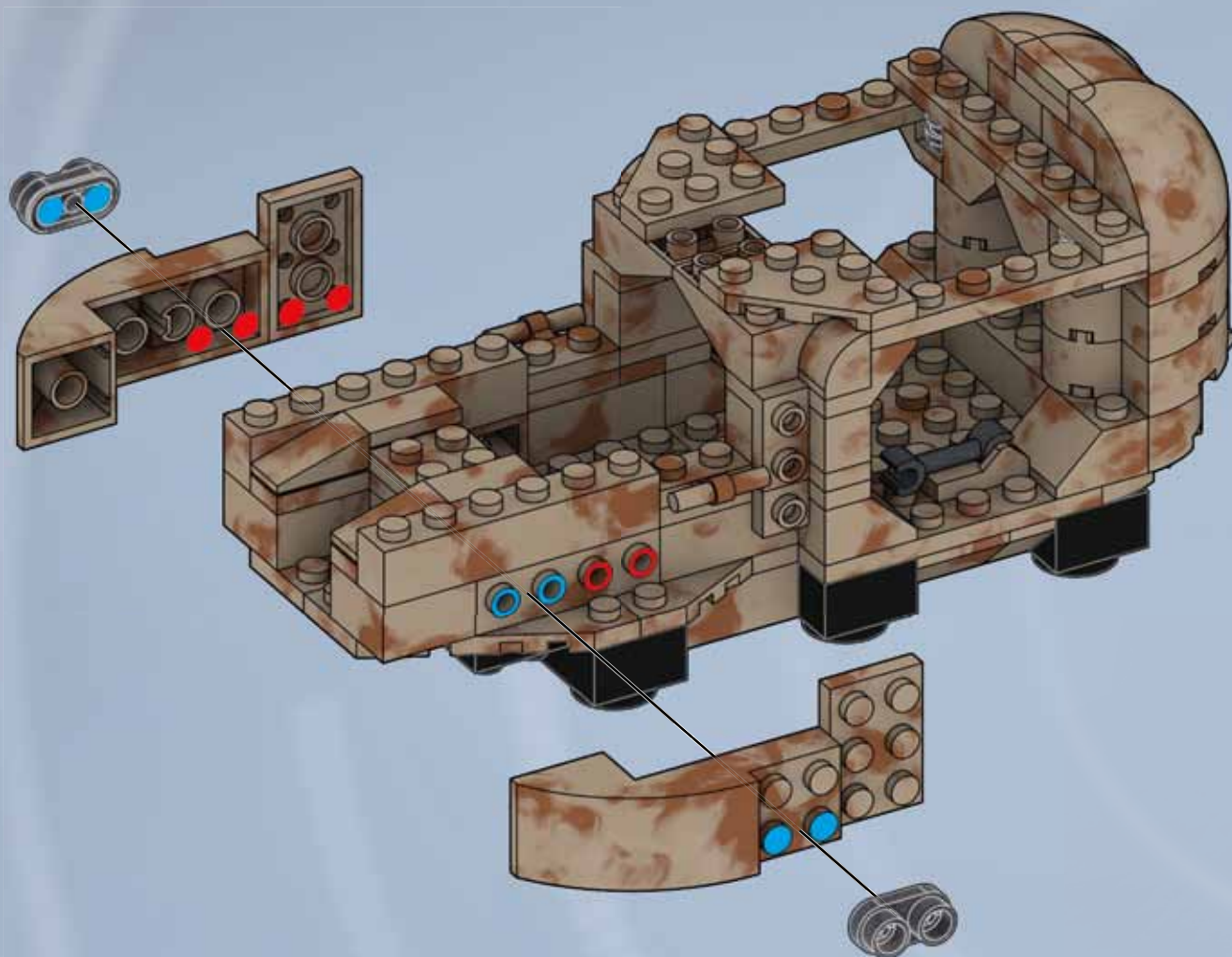



24

2x

4x

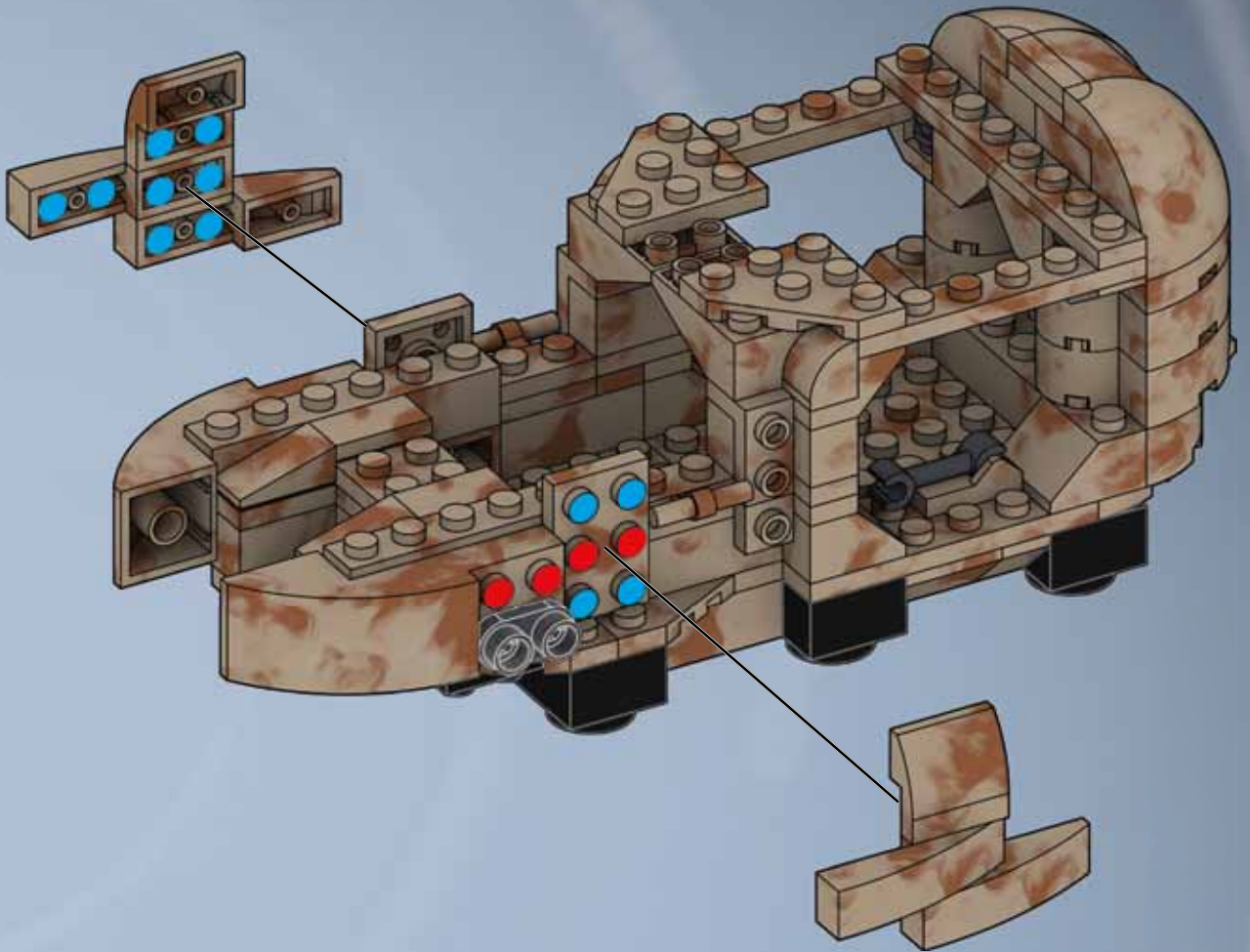

25



2x



4x



2x

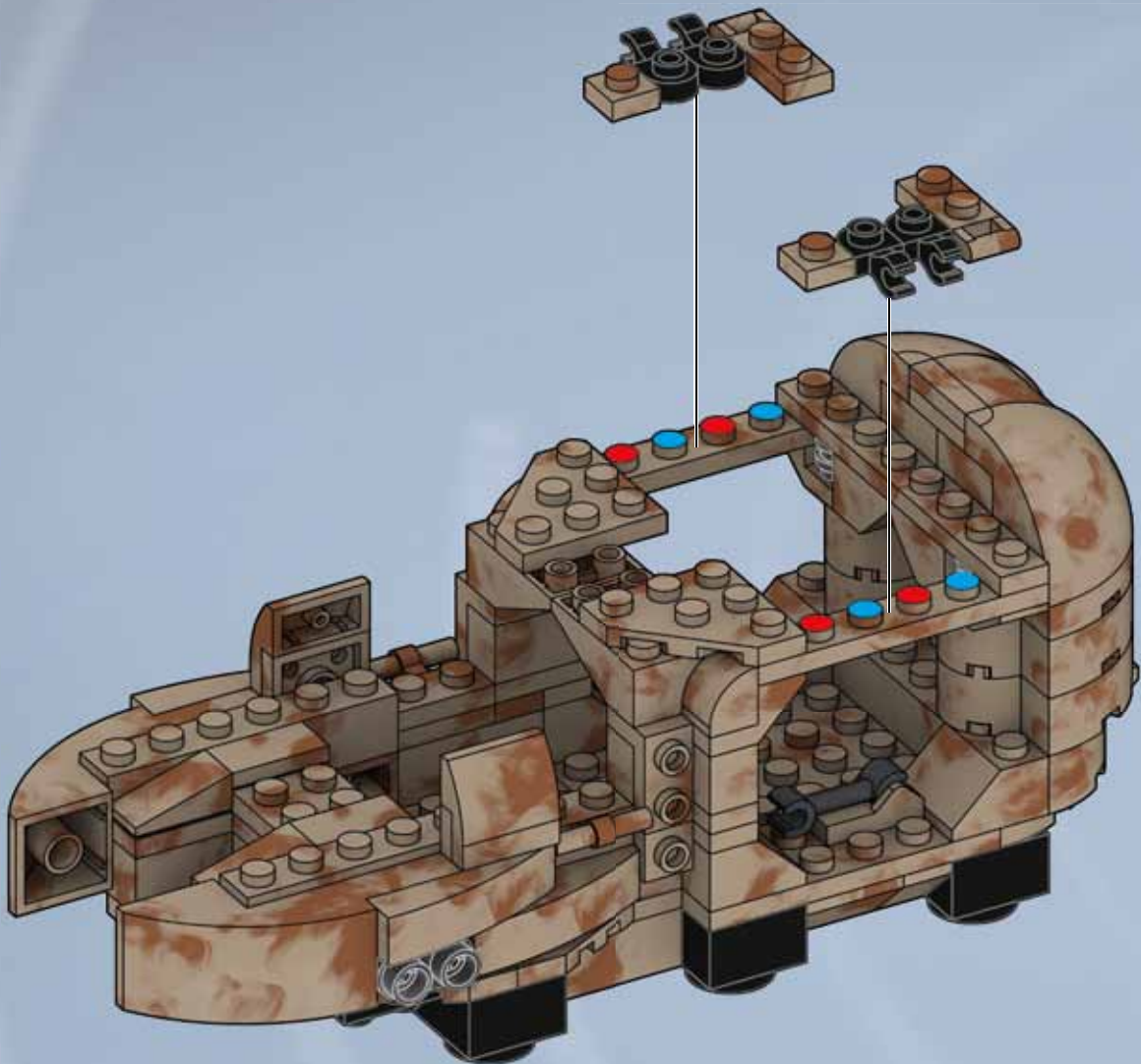





26

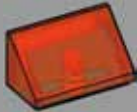

4x

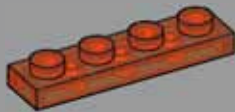

2x

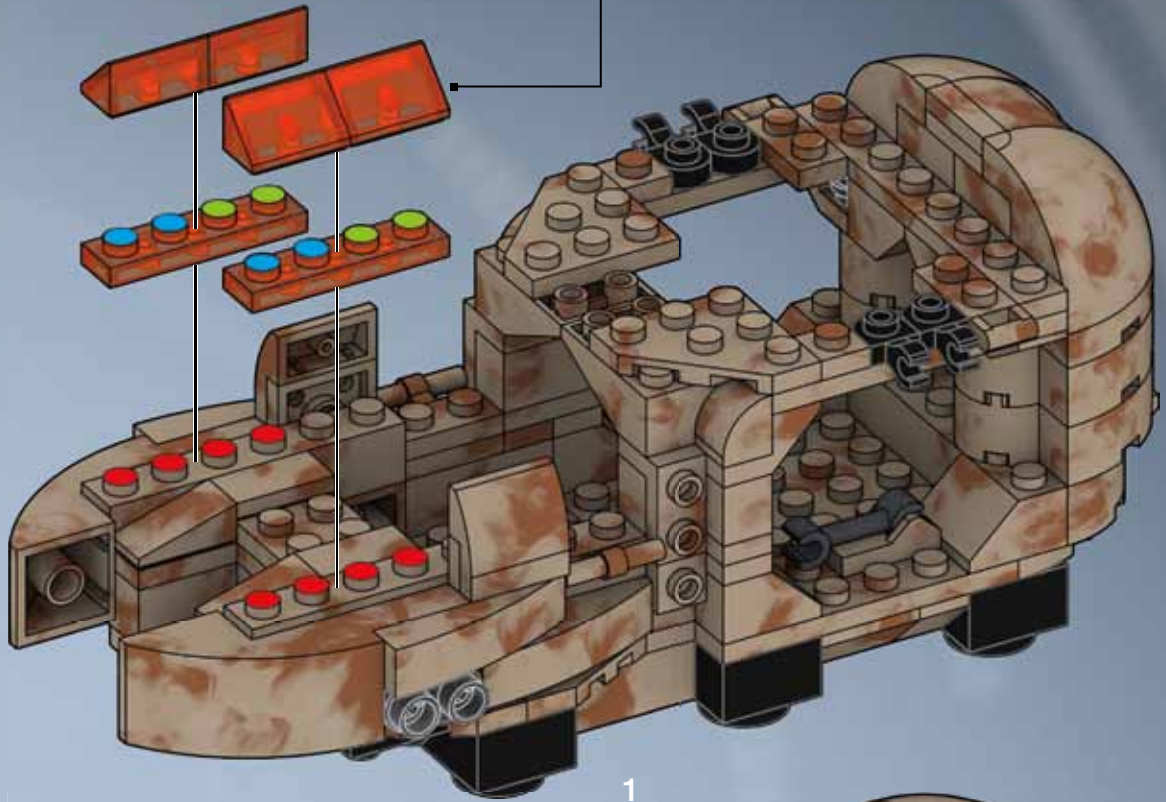

1

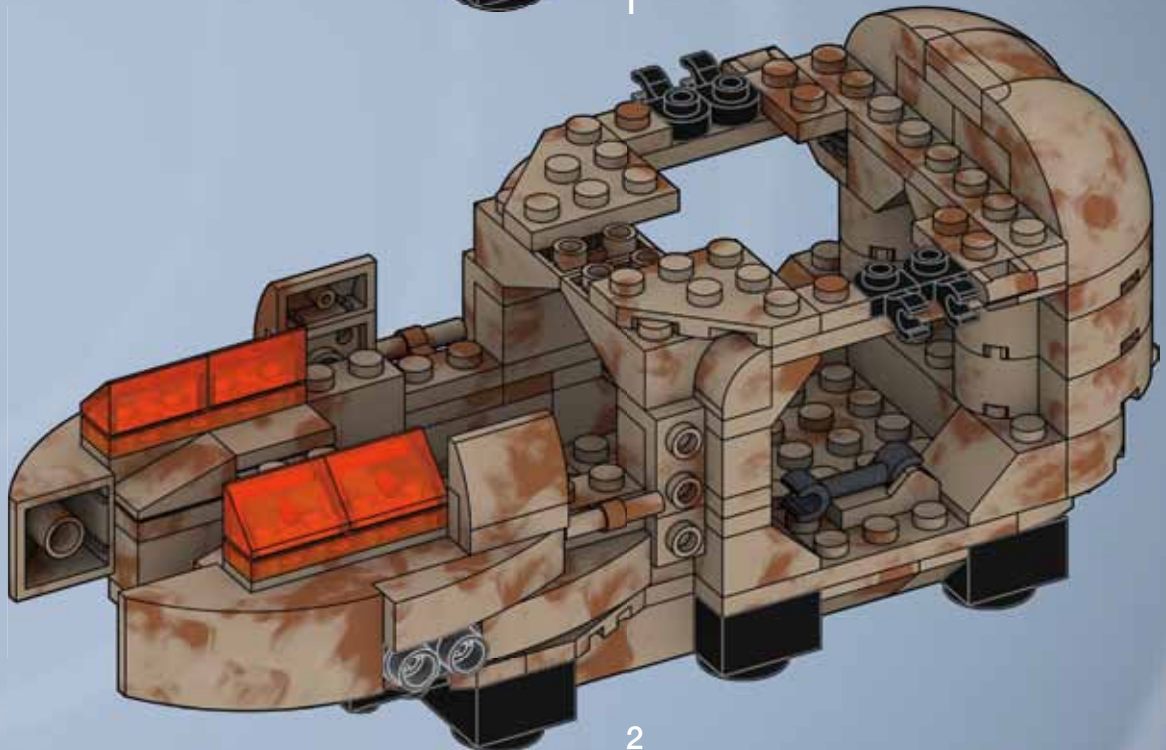

2

**27**

2x 2x 2x 2x 2x

1x 1x 1x 2x

**28**

1x 1x 1x 1x 1x 1x

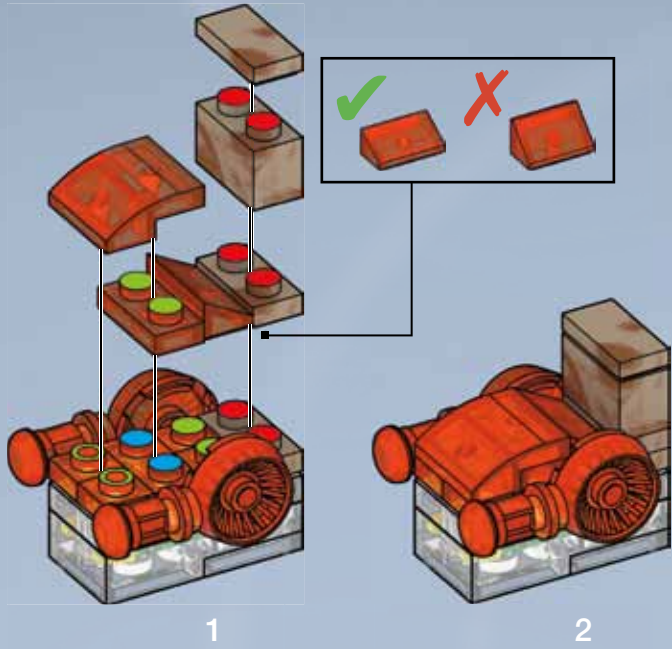
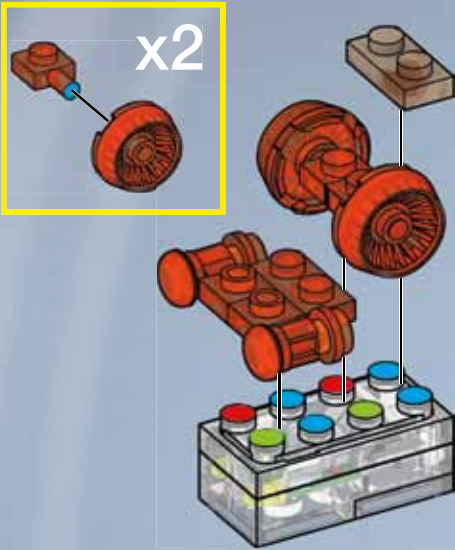
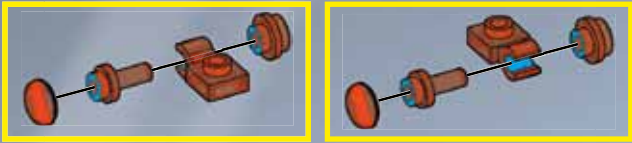

**29**

2x 2x 1x 2x 2x

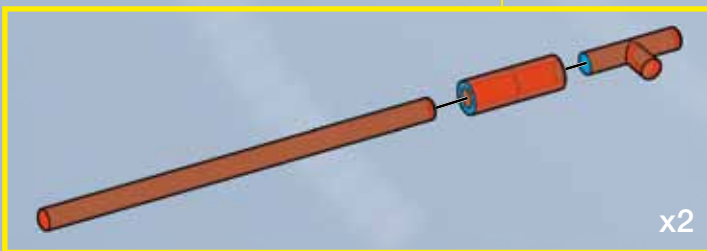
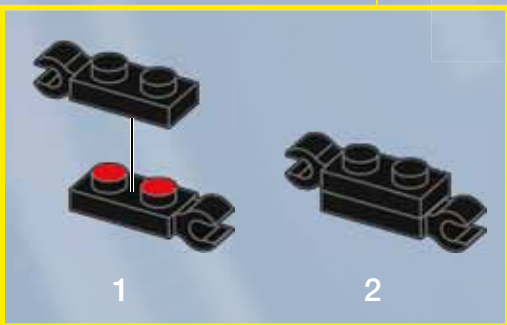
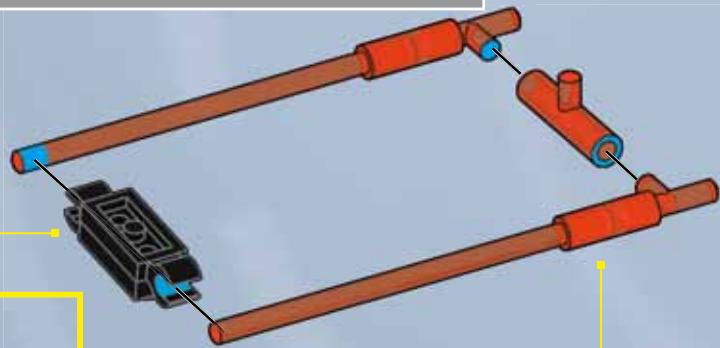

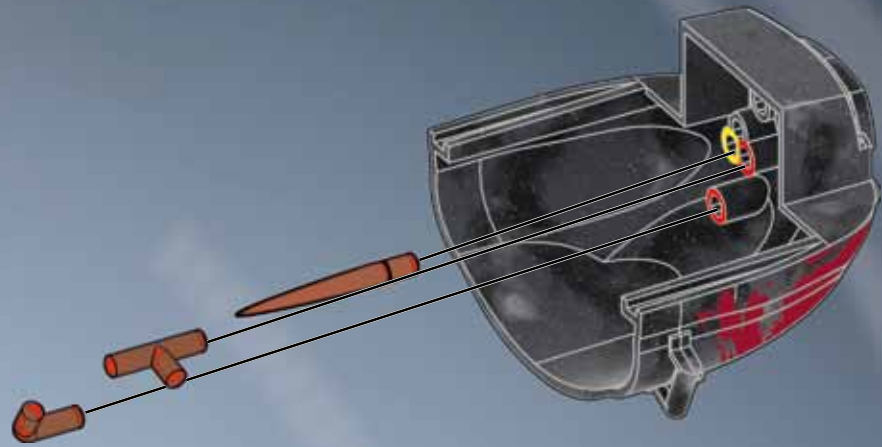
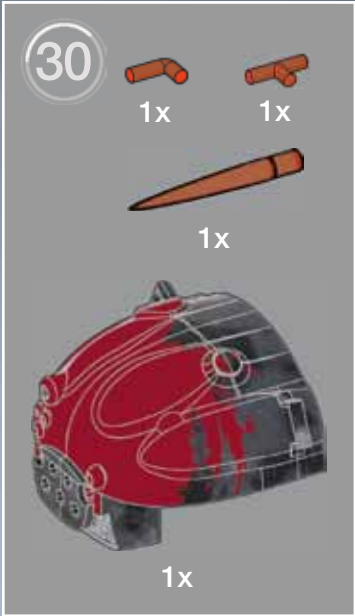

31

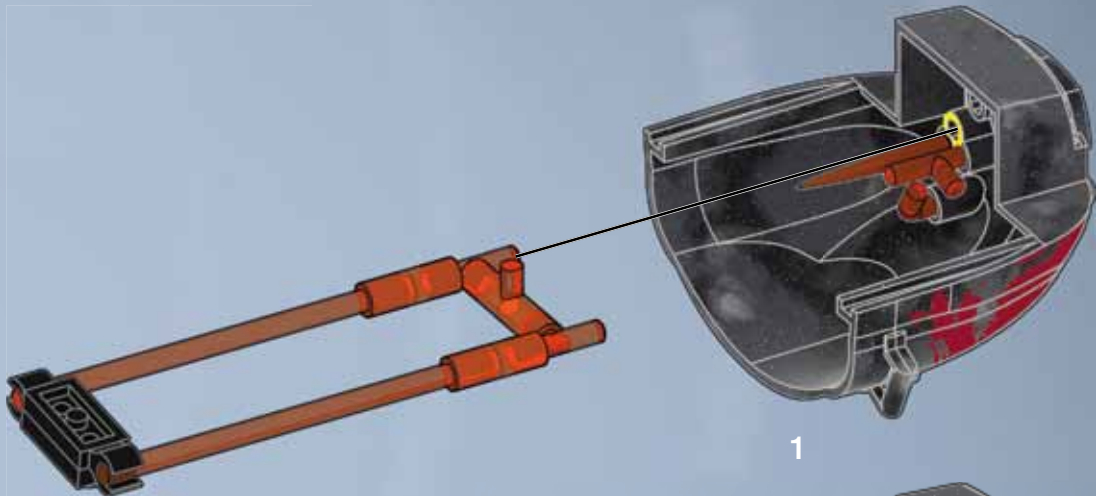

1

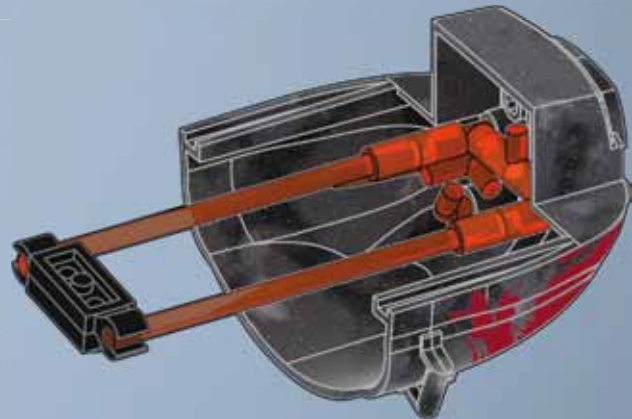

2

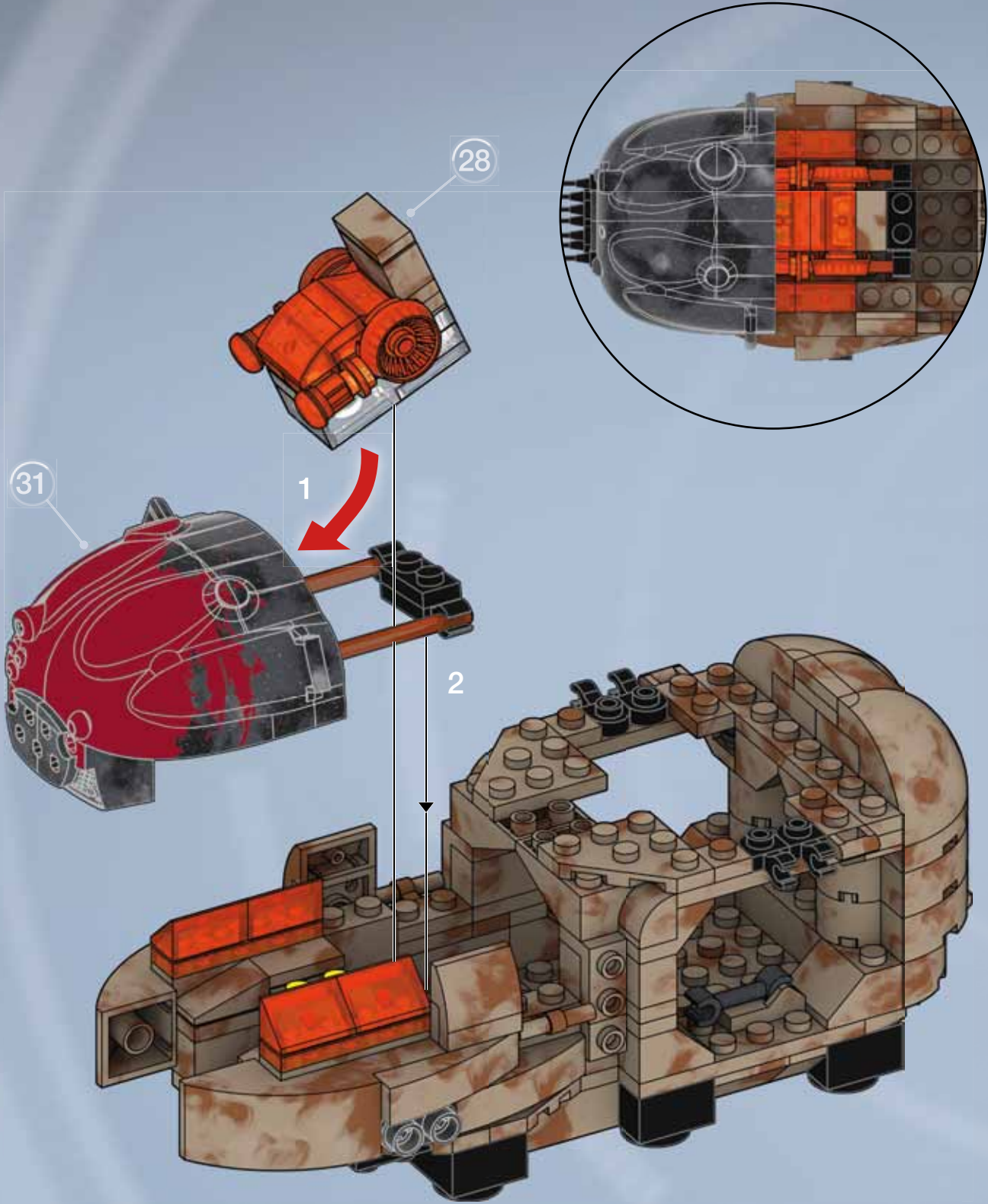



33

2x

2x

2x

2x

1x

2x

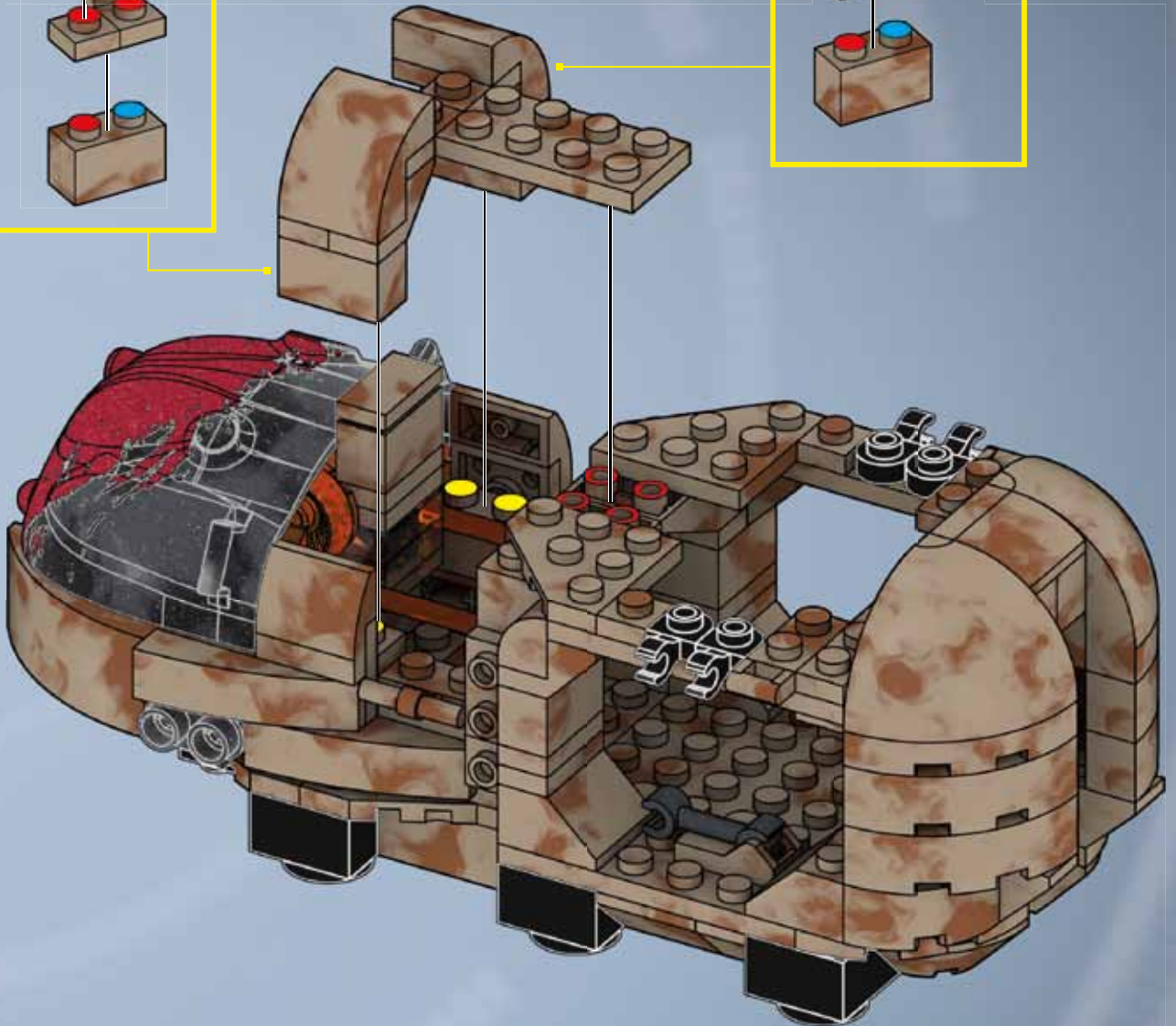
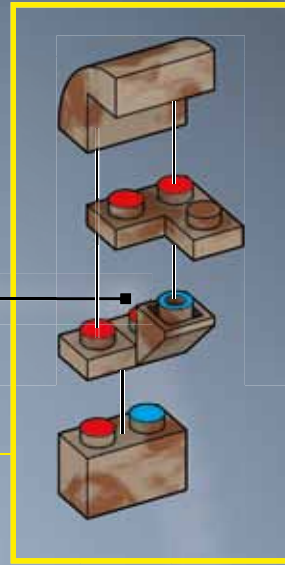
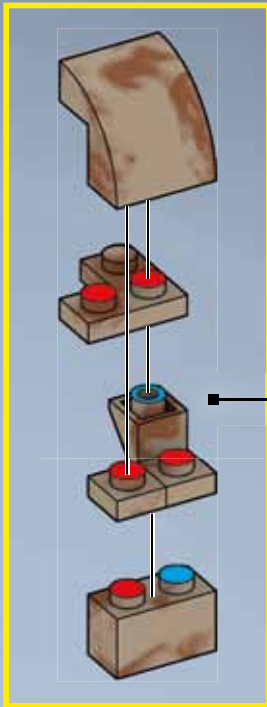

34



1x

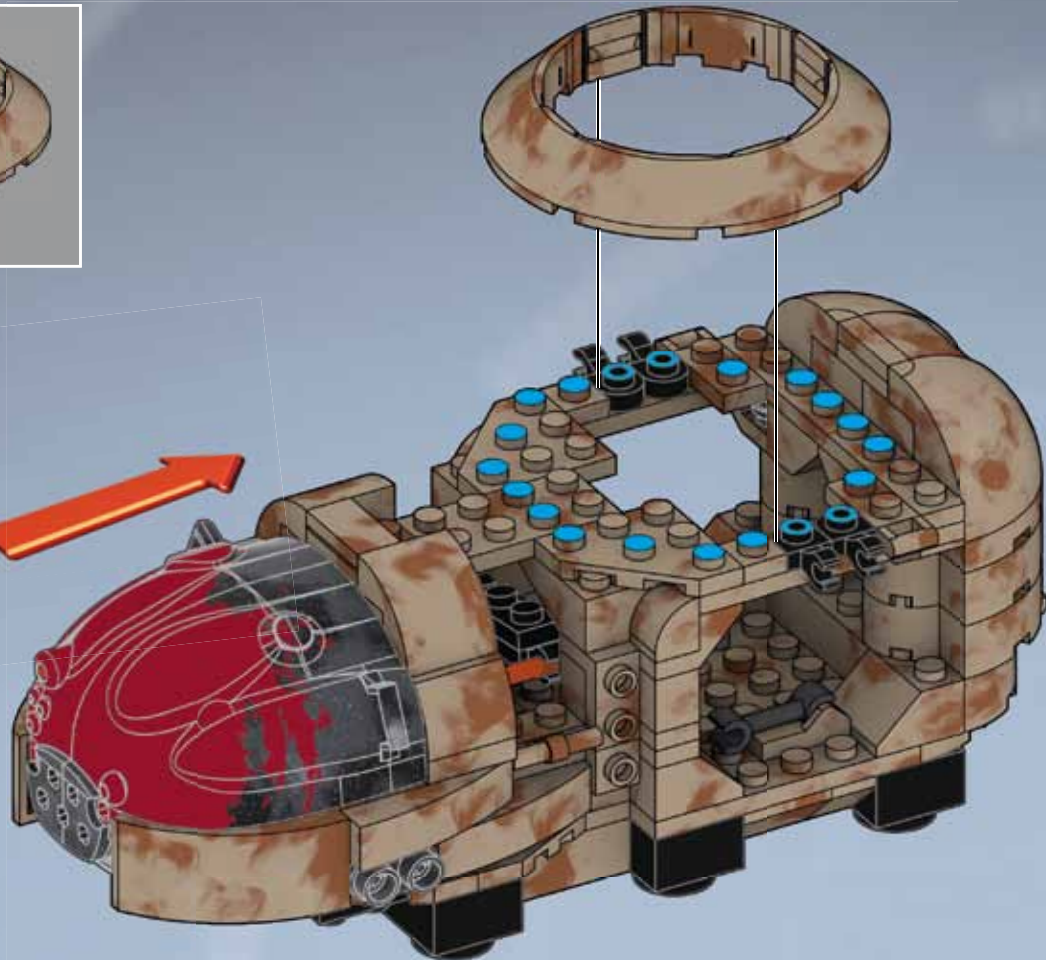
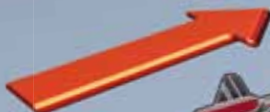

35



1x



2x



1x



1x

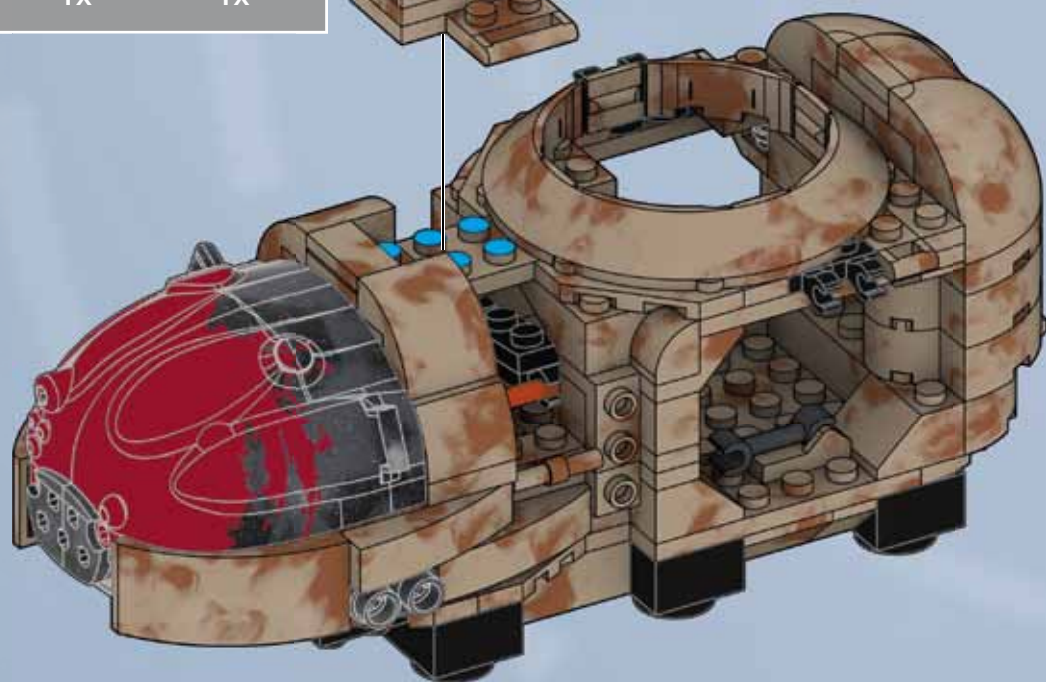
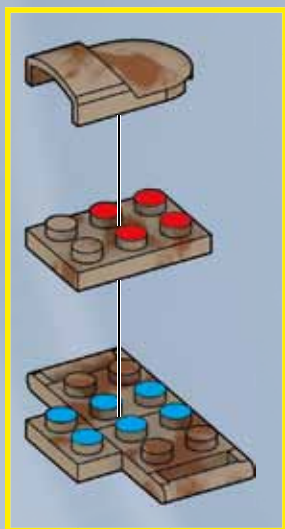



36

- 2x [1x1 tan Technic brick]
- 2x [1x2 tan Technic brick]
- 4x [1x1 tan Technic brick with hole]
- 4x [grey Technic axle]
- 2x [1x2 tan Technic brick with hole]
- 2x [1x2 tan Technic brick with hole]

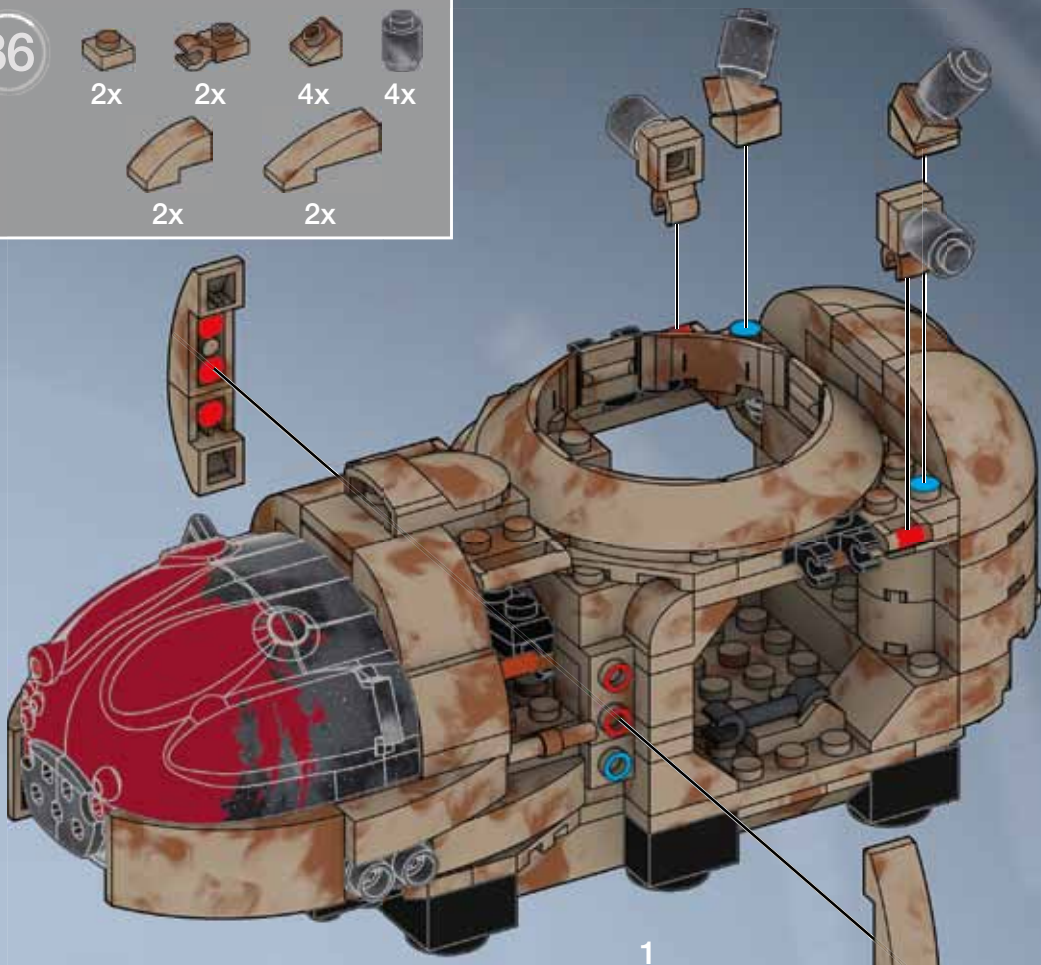

1

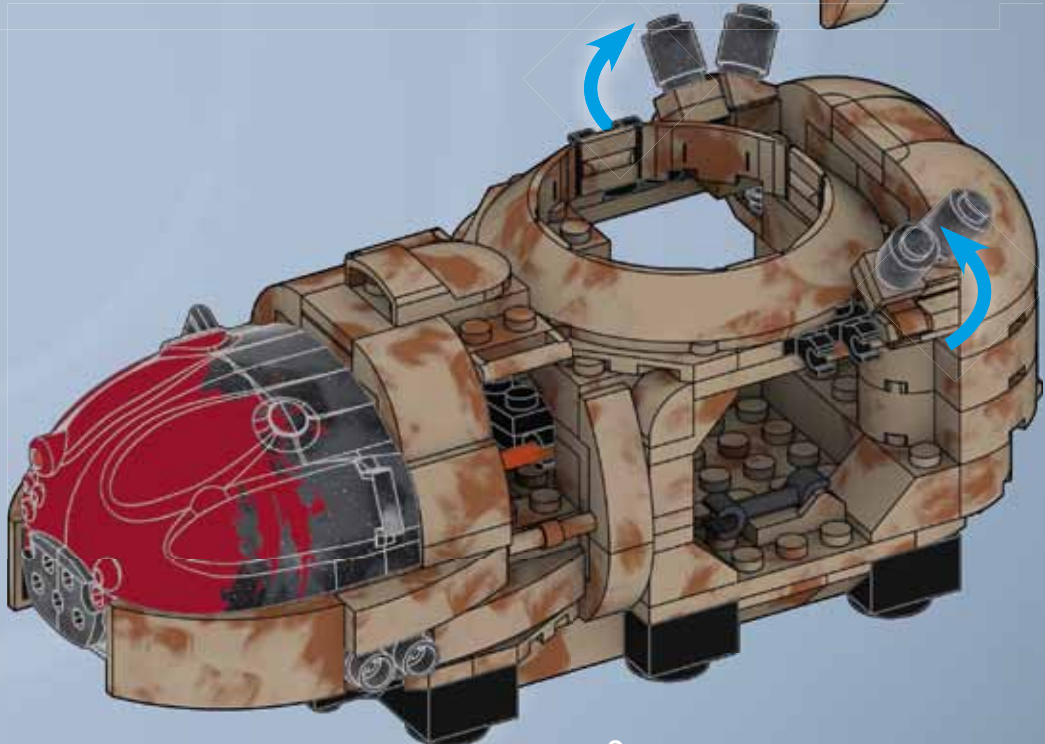

2

