



REBUILD! | RECONSTRUIS!
¡CONSTRUYE UNA Y OTRA VEZ!
¡RECONSTRÒI! | RICOSTRUISCI!
ANDERS AUFGEBAUT! | BUDUJ OD
NOWA | OPNIEUW OUVEN!
ПОСТРОЙ! | ΦΤΙΑΞΤΕ ΞΑΝΑ!
YENİDEN İNŞA ET! | أعد البناء!



or
ou
oder
lub
of
или
ή
veva
أو



or
ou
oder
lub
of
или
ή
veva
أو



or
ou
oder
lub
of
или
ή
veva
أو



Most models can be built one at a time. / La plupart des modèles peuvent être construits un à la fois. / La mayoría de modelos se pueden construir de uno en uno. / A maioria dos modelos pode ser construída separadamente. / La maggior parte dei modelli possono essere realizzati uno per volta. / Die meisten Modelle können eines nach dem anderen gebaut werden. / Większości modeli nie da się budować jednocześnie z innymi. / De meeste modellen kunnen één voor één gebouwd worden. / Большинство моделей могут быть собраны по одной за раз. / De fleste modeller kan bygges enkeltvis. / De flesta modeller kan byggas en i taget. / De fleste modellene kan bygges en om gangen. / Useimmat mallit voidaan rakentaa yksi kerrallaan. / Τα περισσότερα μωτζέλα μπορούν να κατασκευασθούν ένα ένα. / Modellerin çoğu ayrı ayrı inşa edilmeyi gerektirebilir. / 大多數型號可一次性建構。 / ほとんどのモデルは、一度に一つを組み立てることができます。 / تباع كل منها على حدة وتخضع لتوفرها.

5+

DYD38



2x



2x



1x

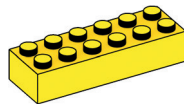

1x

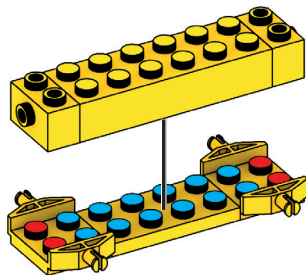

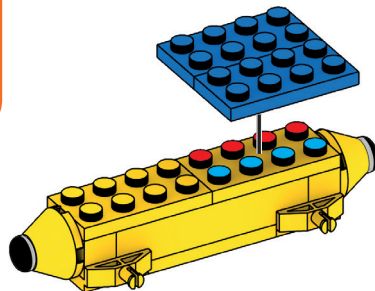
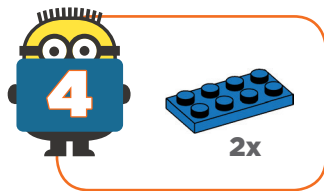
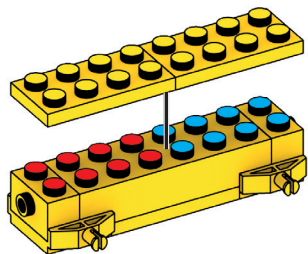
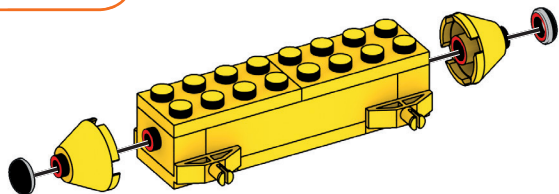
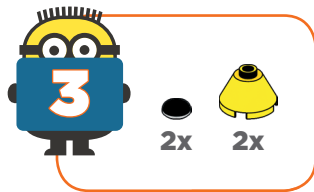
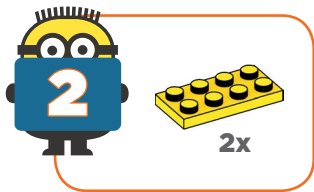



6x



2x



4x



2x



1x



2x

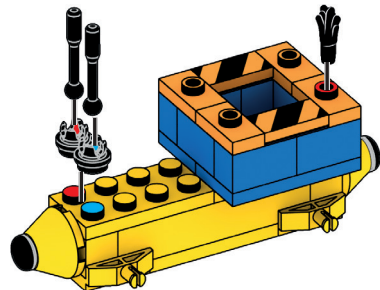
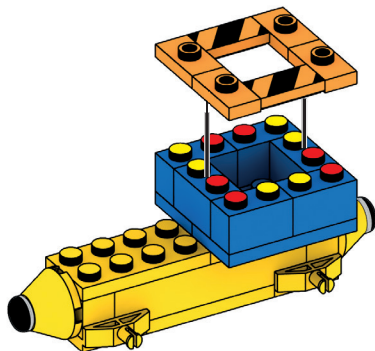
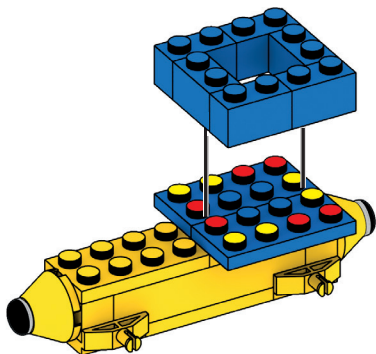

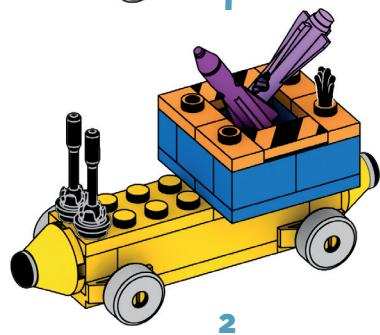
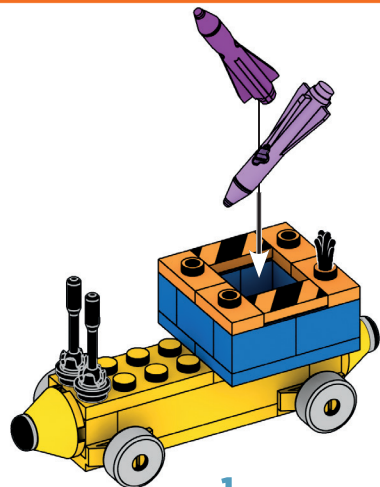
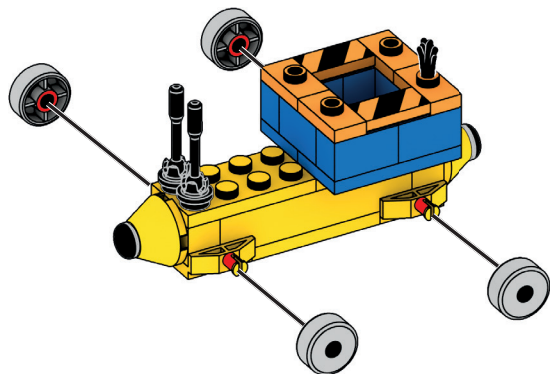
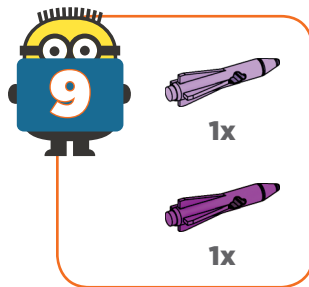
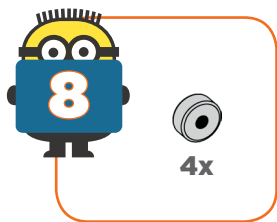

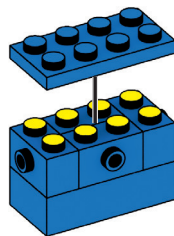
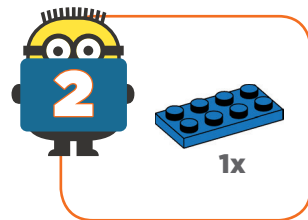
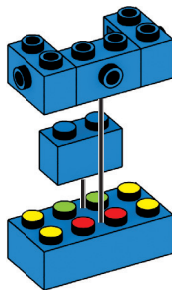
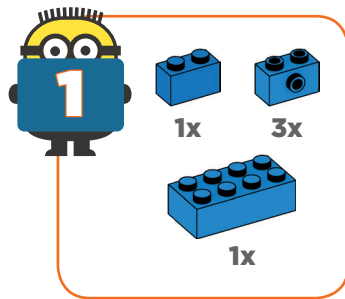

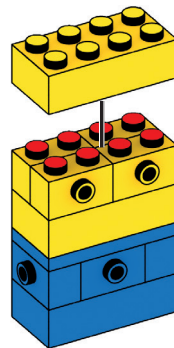
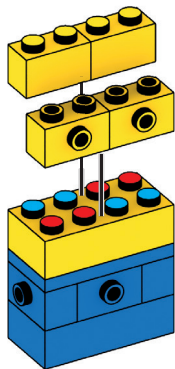
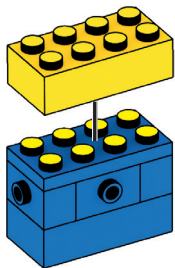
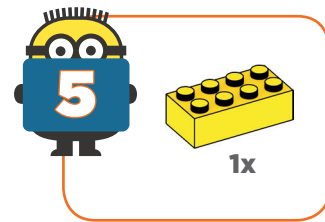
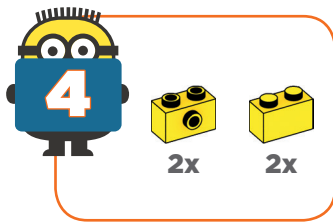
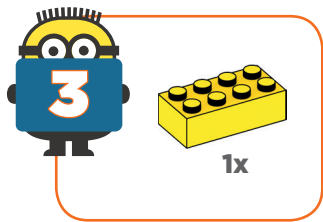



1x

1x



2x

2x

1x

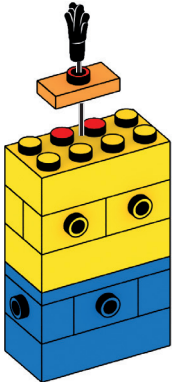

x2

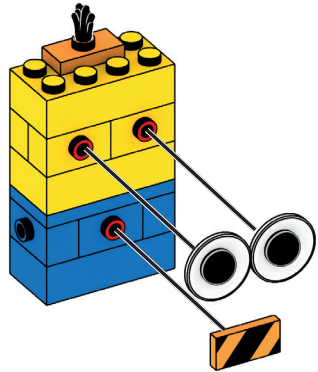



2x



2x



2x

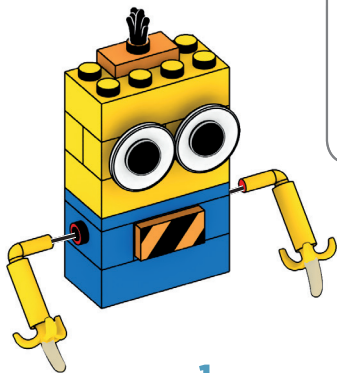
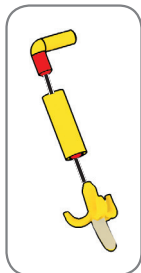

1

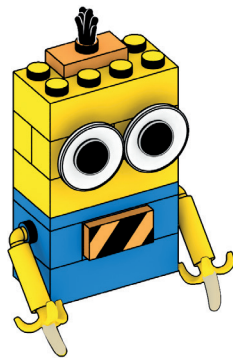
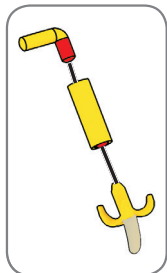

2



2x

2x

2x

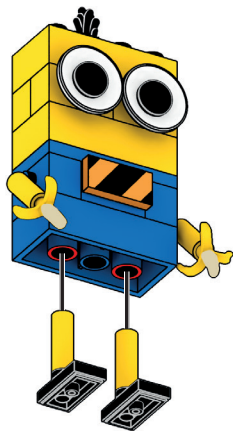
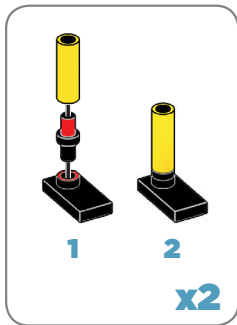

1

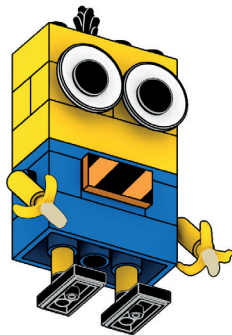

2

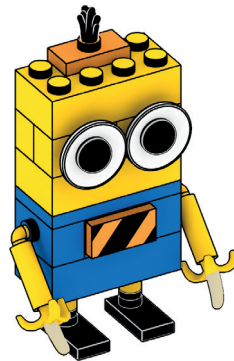

3



1x



2x



1x

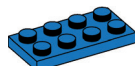

2x

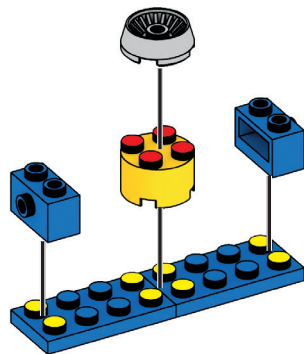



2x



1x



1x

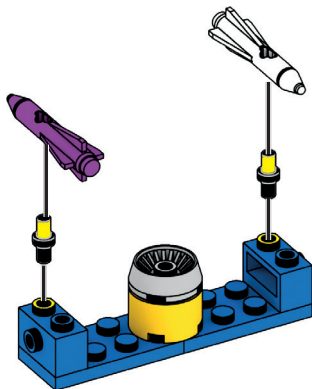

2x

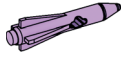

1x

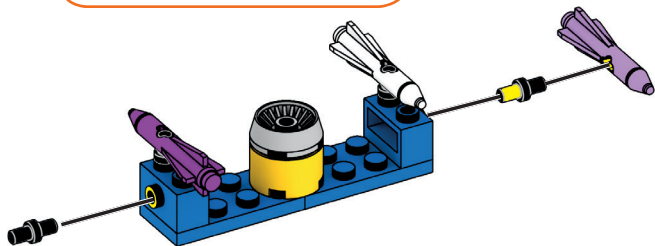

1

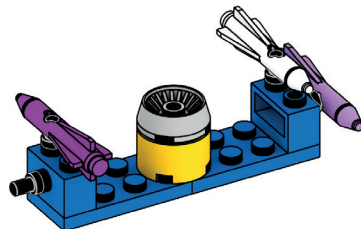

2



2x

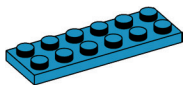

3x



1x



1x



1x



1x

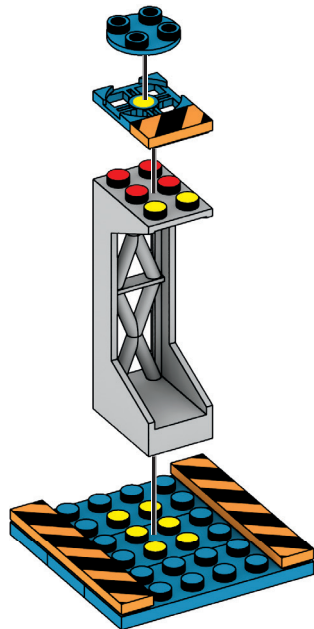
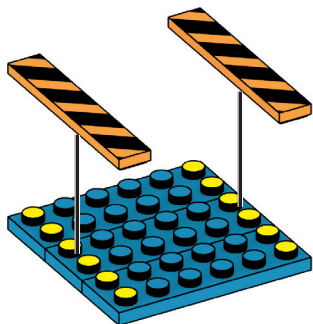



3

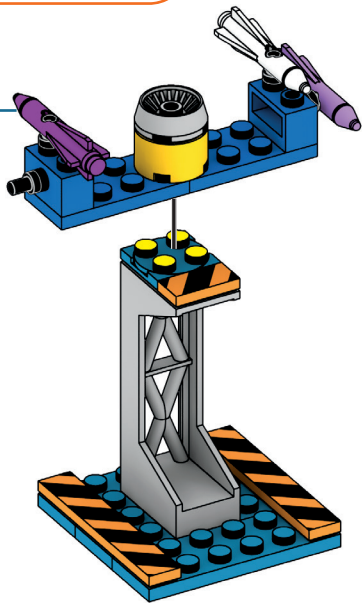

1

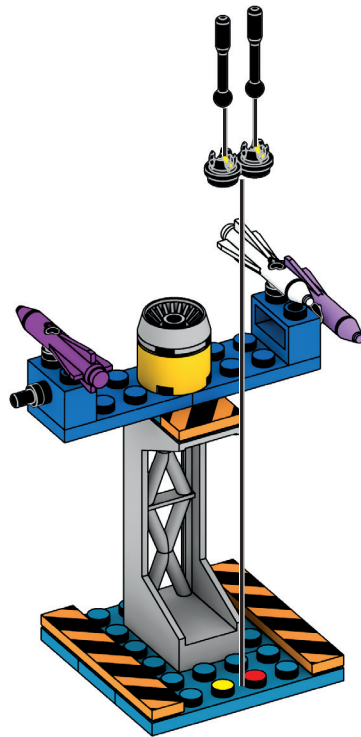

2

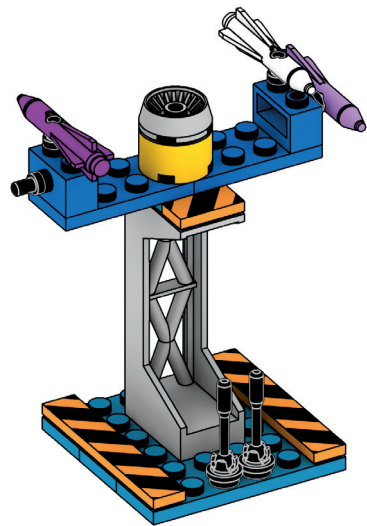

3



1



2





2x



2x



8x

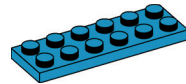

2x

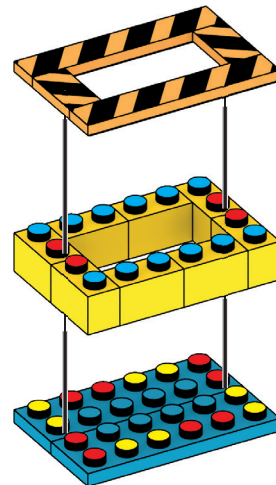
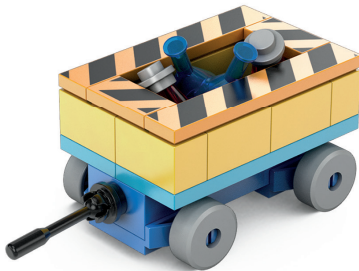



2x

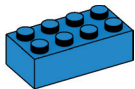

1x



4x



2x

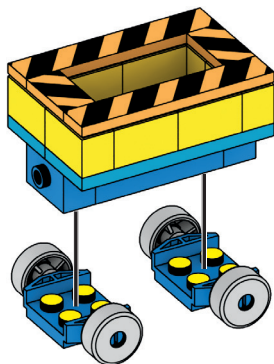
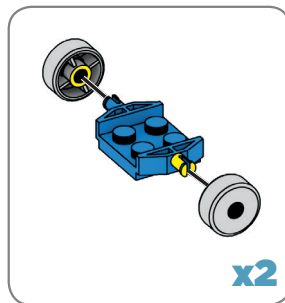
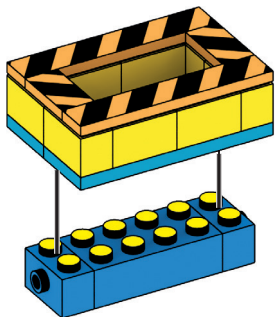



1x



1x



1x



2x



2x



2x

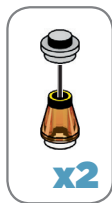

x2

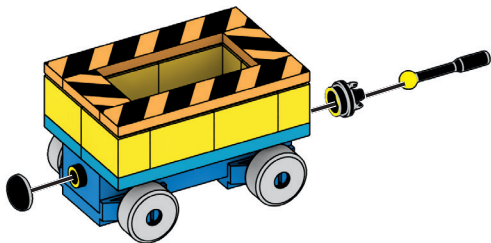

1



2

Please read these instructions carefully before first use and keep them for future reference.
Il est recommandé de lire attentivement ce feuillet avant la première utilisation et de le conserver pour référence future.
Leer estas instrucciones cuidadosamente antes de la primera utilización y guardarlas para referencia futura.

Leia as instruções antes do primeiro uso e guarde-as para futura referência.
Leggere le istruzioni prima di cominciare ad usare il gioco e conservarle per referenze future.
Die Gebrauchsanleitung bitte durchlesen und aufbewahren.

Proszę uważnie przeczytać instrukcję obsługi przed pierwszym użyciem, a następnie zachować ją na przyszłość.
Wij raden u aan deze handleiding zorgvuldig te lezen en te bewaren voor eventuele raadpleging op een later tijdstip.
Внимательно прочитайте инструкцию перед первым использованием и сохраните ее для дальнейшего использования.
Vær venlig at læse disse instruktioner omhyggeligt inden ibrugtagen og opbevar dem til fremtidigt brug.
Läs noggrant igenom dessa instruktioner innan du använder produkten för första gången och spara dem för ev. framtida frågor.
Les disse instruksjonene nøye før første gangs bruk, og ta vare på dem for fremtidige oppslag.

Lue nämä ohjeet huolellisesti ennen ensimmäistä käyttöä ja säilytä ne myöhempää tarvetta varten.
Διαβάστε προσεκτικά τις οδηγίες πριν από τη χρήση και κρατήστε τις για μελλοντική αναφορά.
İlk kullanımdan önce talimatları dikkatlice okumanızı ve bu bilgileri ileride tekrar bakabilmek için saklamanızı öneririz.

第一次使用前，请仔细阅读本说明书并保留以备将来参考。
初めてご使用になる前に、この説明書をよくお読みください。また、本書は将来いつでも参照できるように保管してください。
يجب قراءة هذه التعليمات بعناية قبل الاستخدام والاحتفاظ بها للعودة إليها مستقبلاً.



⚠️ WARNING:
CHOKING HAZARD. - Small parts.
Not for children under 3 years.

⚠️ ATTENTION:
DANGER D'ÉTOUFFEMENT. - Présence de petits éléments.
Ne convient pas aux enfants de moins de 3 ans.

⚠️ 警告:
嚥住危險。包含有小部件
不适合3岁以下的小孩玩。

⚠️ 警告:
のどにつまる危険 小さな部品が含まれています
3歳以下の子供には与えないで下さい。

⚠️ : تحذير
خطر الاختناق - قطع صغيرة.
غير صالحة للأطفال أقل من 3 سنوات.

ADVERTENCIA: Peligro de asfixia. Juguete no recomendado para menores de 3 años, porque contiene piezas pequeñas que podrían provocar asfixia en casode ser ingeridas o inhaladas por el/la niño/a.

ATENÇÃO: Não recomendável para crianças com menos de 36 meses. Contém peças pequenas capazes de criar risco de asfixia.

AVVERTENZA: Contiene pezzi di piccole dimensioni.

ACHTUNG: Kleine Teile.

OSTRZEŻENIE: Małe części

WAARSCHUWING: Kleine onderdelen

ПРЕДУПРЕЖДЕНИЕ: Мелкие детали

ADVARSEL: Små dele.

VARNING: Smådelar

ADVARSEL: Små deler.

VAROITUS: Pieniä osia

ΠΡΟΣΟΧΗ: Περιλαμβάνονται μικρά κομμάτια.

UYARI: BOĞULMA TEHLİKESİ - Küçük Parçalar İçerir. 3 yaşından küçük çocuklar için uygun değildir.



MEGA CONSTRUX™

Build Beyond™



Au-delà de la construction !

¡Construye sin límites!

Mais do que Construção!

Costruisci oltre ogni limite!

Es gibt keine Grenzen!

Więcej niż budowanie!

Meer dan alleen bouwen!

Больше, чем конструктор!

Χτίσε έναν ολόκληρο κόσμο!

Hayallerini İnşa Et!

لبنني .. وأكثر!



www.despicable.me #DespicableMe

Despicable Me, Minion Made and all related marks and characters are trademarks and copyrights of Universal Studios. Licensed by Universal Studios Licensing LLC. All Rights Reserved.

©2016, MEGA Brands Inc. & ™ MEGA Brands Inc. CONSTRUX™ is owned by Mattel and used under license. CONSTRUX™ appartient à Mattel et est utilisée sous licence. D-DYD38-01-WEB

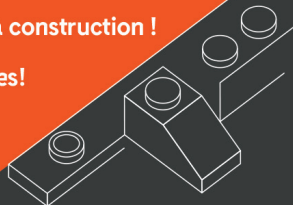

play.megaconstrux.com

