

MEGA  
CONSTRUX™

HALO

1



FDY55

- 8x AM17062AWB
- 3x MA17003F
- 3x MA74397F
- 3x AM76060AWB
- 8x AM78600AWB
- 2x M1113ZD
- 18x MA07223F
- 1x AS-FDY55-06
- 16x MA03328F
- 4x M03328AWB
- 3x MA03328APD
- 4x AM77574APD
- 1x AM77574F

- 1x AM78219F
- 1x AM74300F
- 2x AM74300APD
- 1x AM74299F
- 2x AM74299APD
- 6x MA19999F
- 3x MA18623F
- 10x AM16980AWB
- 4x MA17787F
- 4x MA17127APD
- 2x MA17127F

- 8x MA15258APD
- 1x AM08412F
- 1x MA1140F
- 1x AM76029F
- 10x AM74415F
- 2x AM76054APD
- 4x AM76054F
- 10x MA17201APD
- 2x AM18592F
- 4x M19392AWB
- 8x MA19392AMC

- 4x AM18597AWB
- 4x M17506AWB
- 3x MA73758APD
- 13x MA022501APD
- 2x M022501ZD
- 11x MA022501F
- 1x AS-FDY55-07
- 7x M09198AWB
- 10x MA09393APD
- 8x MA09393F
- 2x M09393X
- 2x MA18901F

- 4x MA17128F
- 15x MA17128APD
- 2x MA04430APD
- 6x MA18549APD
- 4x MA18549F
- 4x MA03019APD
- 2x MA03019AWB
- 1x AS-FDY55-08
- 1x AS-FDY55-09
- 8x AM03017APD

- 2x AM76467AWB
- 10x AM76467APD
- 14x AM18272APD
- 6x MA09835APD
- 2x MA09835F
- 12x MA72002F
- 4x MA17522F
- 12x AM18740APD
- 2x M72000AWB
- 4x MA1417APD

- 7x MA09013F
- 4x MA09013APD
- 6x M09013AWB
- 6x MA17502APD
- 2x MA18666F
- 1x MA18666APD
- 2x MA18665F
- 1x MA18665APD
- 4x M15484AWB
- 12x MA15484APD

- 6x MA18293F
- 1x MA03484F
- 1x MA03485F
- 3x AM18525AWB
- 12x MA03773APD
- 2x MA1146APD
- 2x MA09267F
- 2x MA09268F
- 4x AM03330F
- 4x AM74106F

- 5x MA1314F
- 6x MA1314APD
- 6x MA18671F
- 5x MA18329F
- 4x MA18329APD
- 4x MA18328APD
- 1x AS-FDY55-04
- 2x AM19899APD
- 6x MA1323APD
- 2x MA16384F



8x  
MA09106APD



4x  
AM73233F



4x  
AM74060AWB



4x  
AM73903AWB

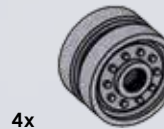

4x  
AM73902AWB

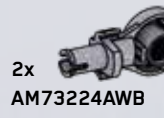

2x  
AM73224AWB

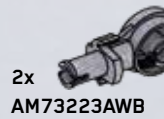

2x  
AM73223AWB



2x  
AM73228AWB

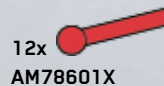

12x  
AM78601X



11x  
MA03772APD



2x  
MA03772F



1x  
MA03873MM



9x  
AM74139APD

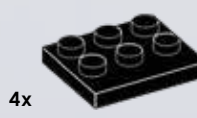

4x  
AM74139F



1x  
MA04497APD



2x  
AS-FDY55-03



2x  
M09931AWB



8x  
AM78599AWB



4x  
MA16959F



2x  
M09838AAV



4x  
MA09838APD



12x  
MA09838F



6x  
MA09593APD



13x  
MA09593F



2x  
M09593AWB



2x  
AS-FDY55-05



1x  
AM01390F



2x  
AM18282APD



3x  
AM18283APD



2x  
AM77463APD



2x  
AS-FDY55-02



2x  
AM77463AWB



2x  
MA01531F



3x  
MA09493APD



4x  
M09493AWB



11x  
MA09493F



3x  
AM16653F



5x  
MA1087F



5x  
MA17503F



2x  
MA09033APD



2x  
MA07475APD



1x  
AM73234F

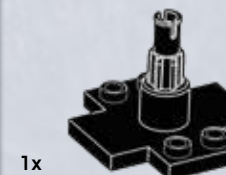

1x  
AM73235F



2x  
AS-FDY55-10



1x  
M09292AWB



4x  
MA09292F



3x  
MA09292APD



3x  
AM76357ANW



2x  
MA1313APD



5x  
M1313AWB



2x  
MA1313F



3x  
MA01480F



7x  
MA1480APD

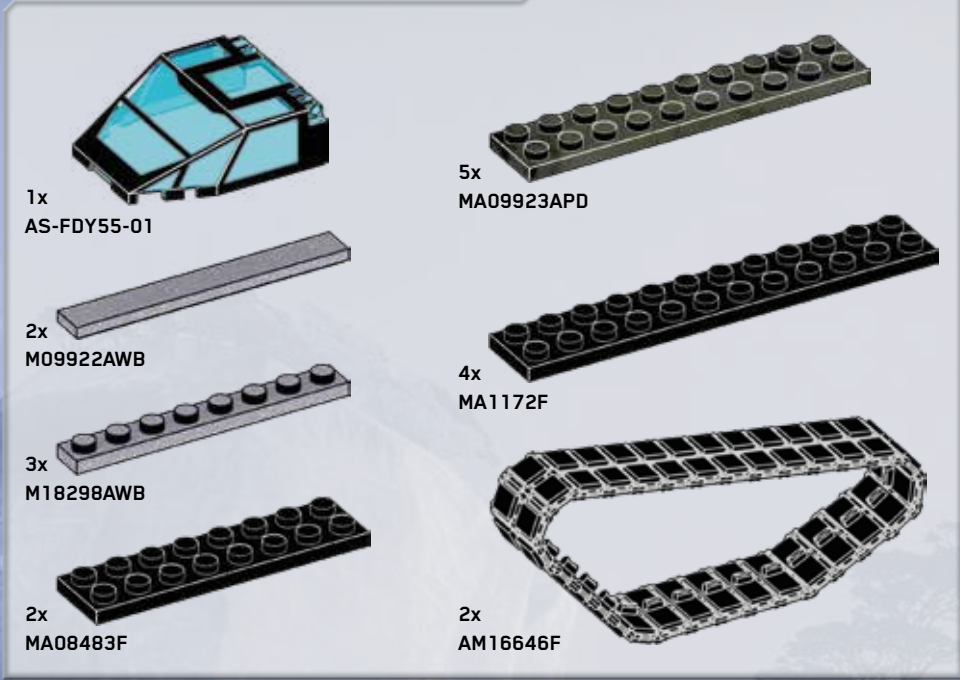

Please read these instructions carefully before first use and keep them for future reference.  
 Il est recommandé de lire attentivement ce feuillet avant la première utilisation et de le conserver pour référence future.  
 Leer estas instrucciones cuidadosamente antes de la primera utilización y guardarlas para referencia futura.  
 Leia as instruções antes do primeiro uso e guarde-as para futura referência.  
 Leggere le istruzioni prima di cominciare ad usare il gioco e conservarle per referenze future.  
 Die Gebrauchsanleitung bitte durchlesen und aufbewahren.  
 Proszę uważnie przeczytać instrukcję obsługi przed pierwszym użyciem, a następnie zachować ją na przyszłość.  
 Wij raden u aan deze handleiding zorgvuldig te lezen en te bewaren voor eventuele raadpleging op een later tijdstip.  
 Внимательно прочитайте инструкцию перед первым использованием и сохраните ее для дальнейшего использования.  
 Vær venlig at læse disse instruktioner omhyggeligt inden ibrugtagen og opbevar dem til fremtidigt brug.  
 Läs noggrant igenom dessa instruktioner innan du använder produkten för första gången och spara dem för ev. framtida frågor.  
 Les disse instruksjonene nøye før første gangs bruk, og ta vare på dem for fremtidige oppslag.  
 Lue nämä ohjeet huolellisesti ennen ensimmäistä käyttöä ja säilytä ne myöhempää tarvetta varten.  
 Διαβάστε προσεκτικά τις οδηγίες πριν από τη χρήση και κρατήστε τις για μελλοντική αναφορά.  
 İlk kullanımdan önce talimatları dikkatlice okumanızı ve bu bilgileri ileride tekrar bakabilmek için saklamanızı öneririz.  
 第一次使用前，请仔细阅读本说明书并保留以备将来参考。  
 初めてご使用になる前に、この説明書をよくお読みください。また、本書は将来いつでも参照できるように保管してください。  
 يجب قراءة هذه التعليمات بعناية قبل الاستخدام والاحتفاظ بها للعودة إليها مستقبلاً.



© 2016 MICROSOFT CORPORATION. ALL RIGHTS RESERVED.  
 MICROSOFT, 343 INDUSTRIES, THE 343 INDUSTRIES LOGO, HALO, THE HALO LOGO ARE TRADEMARKS OF THE MICROSOFT GROUP OF COMPANIES.

Ⓟ D714,887 Patent pending.

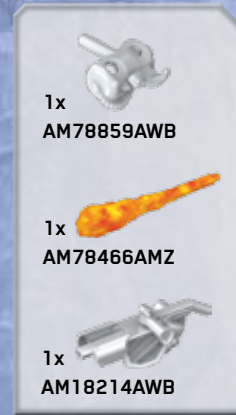
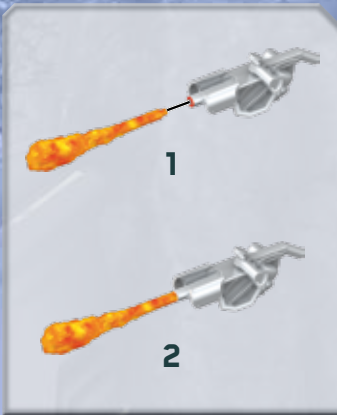



BRUTE SHOT



ASSAULT RIFLE



FLAME THROWER



UNSC Flame Trooper



UNSC Marine



Banished Brute

1

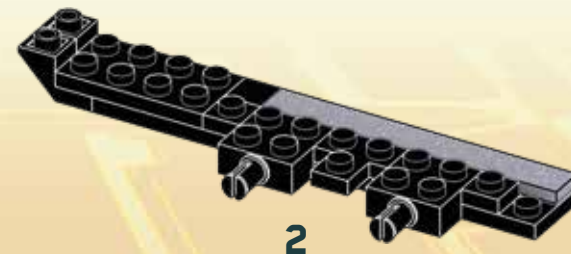
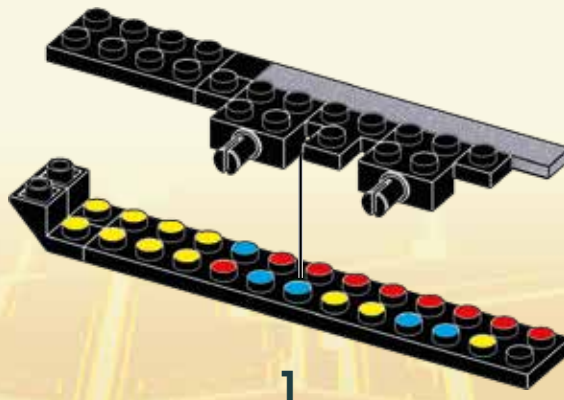
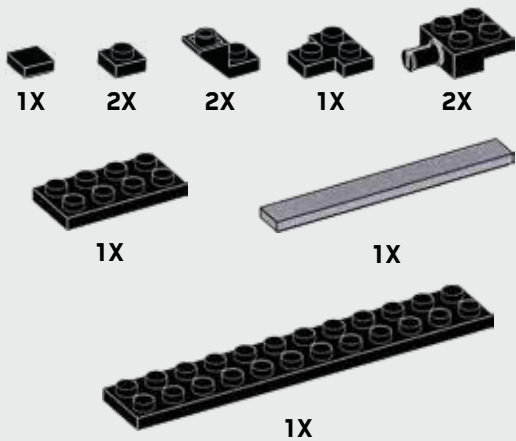

1

2

2

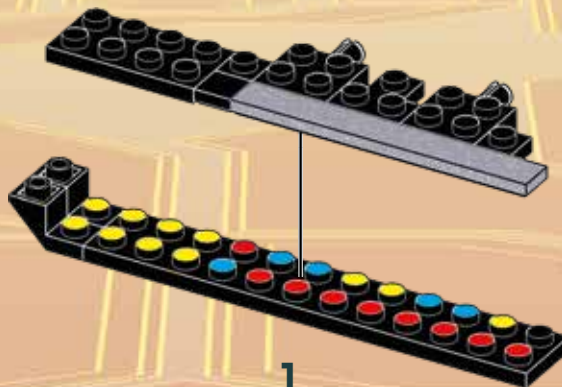
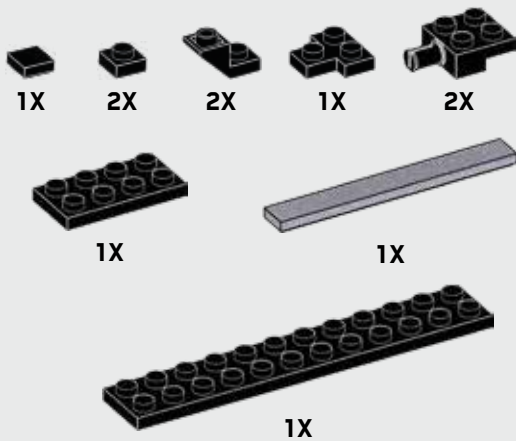

1

2

3

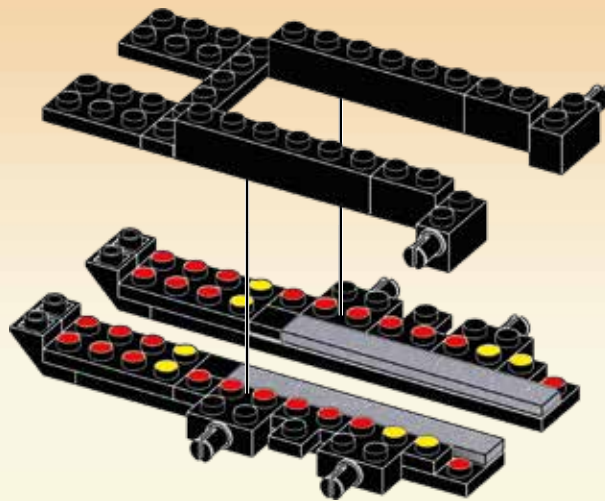
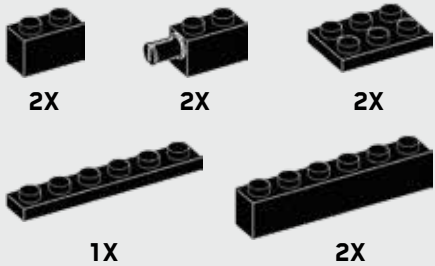

1

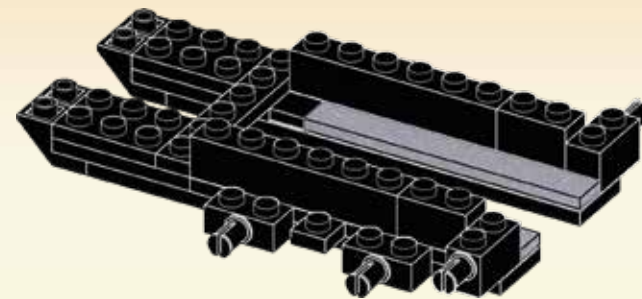

2

4

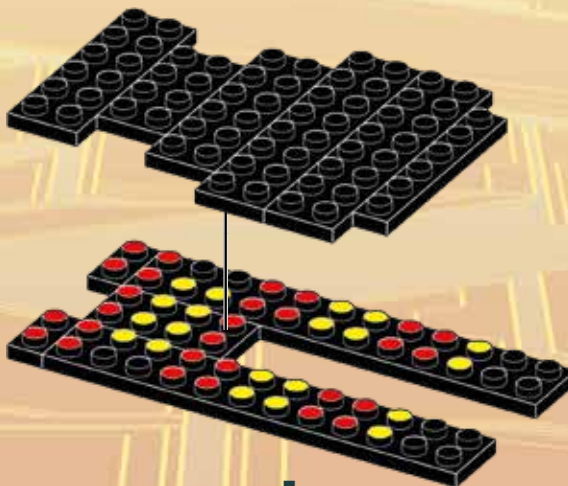
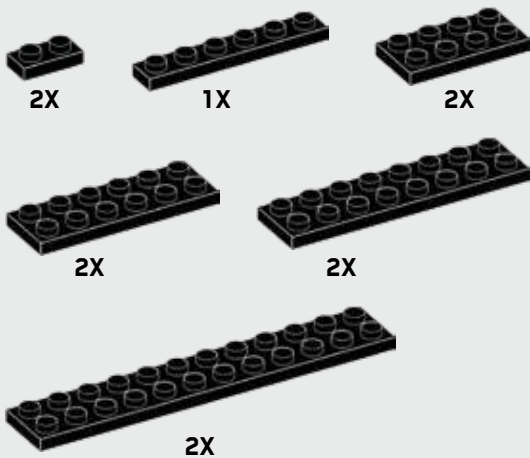

1



2

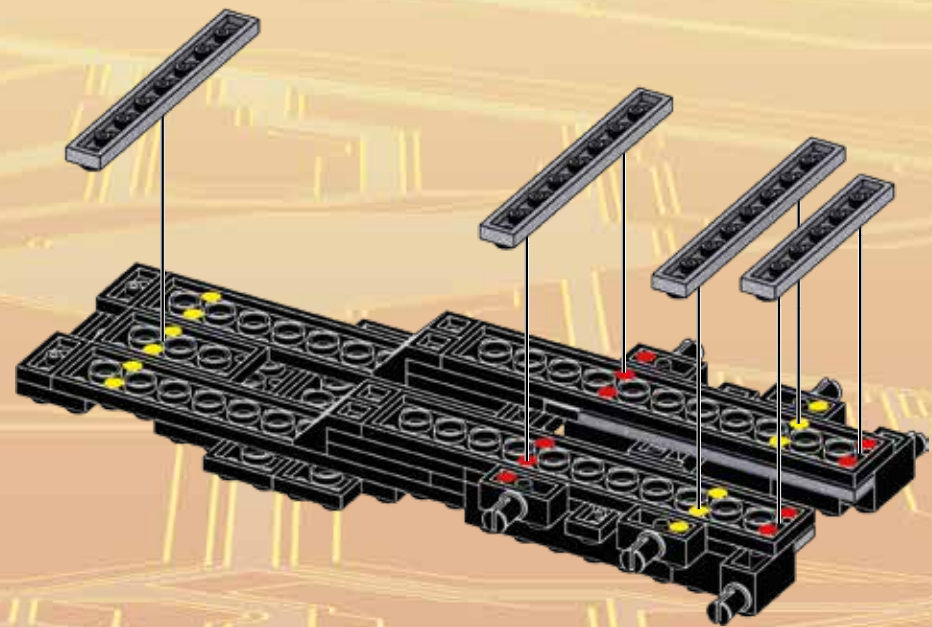
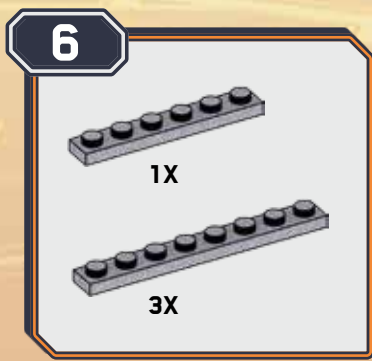
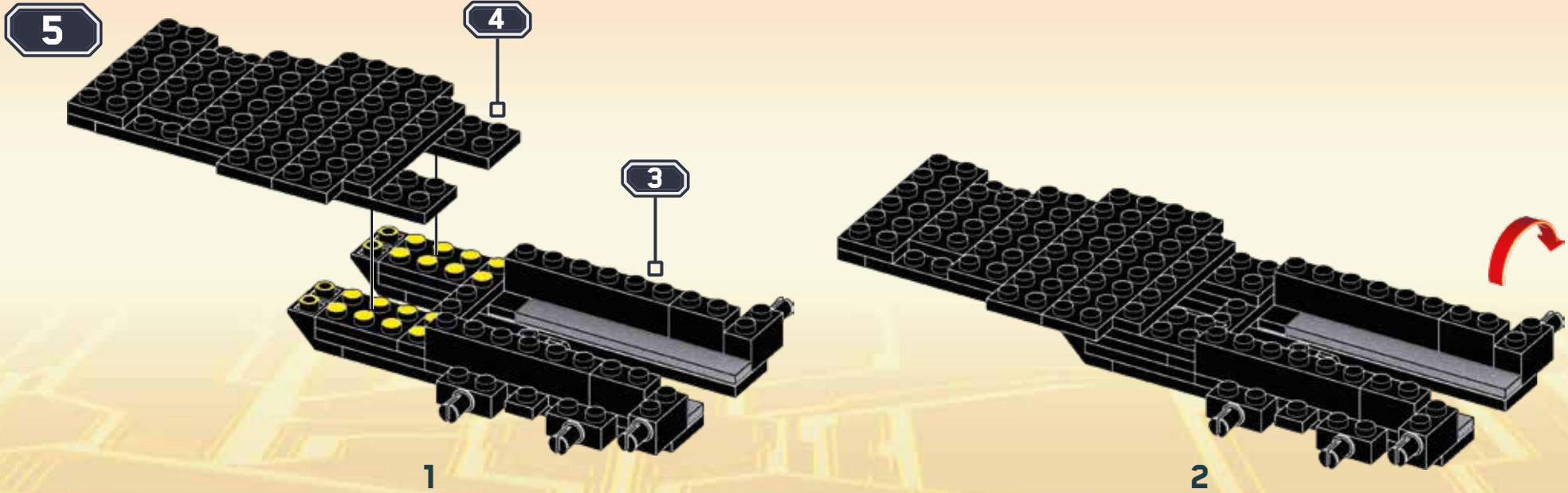



7



1X

Place temporary piece  
 Placer la pièce temporaire  
 Colocar la pieza provisional  
 Colocar a peça temporária  
 Posizionare il pezzo provvisorio  
 Das vorübergehend benötigte Teil platzieren  
 Umieść tymczasowy element  
 Plaats tijdelijk deel  
 Поместите временную деталь  
 Placér midlertidigt stykke.  
 Placera temporär del  
 Plasser midlertidig del  
 Aseta väliaikainen osa  
 Τοποθετήστε το προσωρινό κομμάτι  
 Geçici parçayı yerleştirin  
 放置臨時件  
 暫定ピースを配置してください  
 ضع القطعة المؤقتة

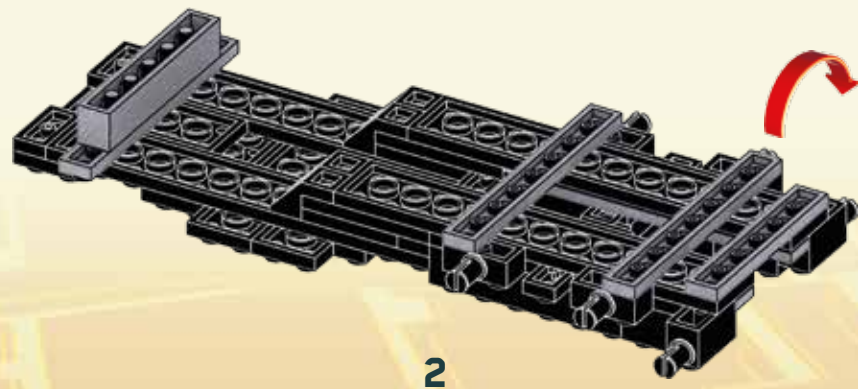
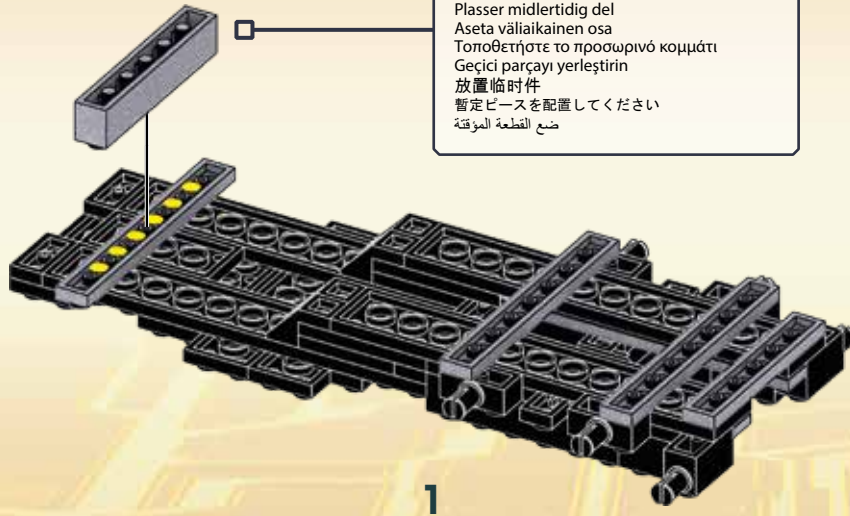

8



2X



2X



2 X



x2



1

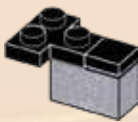

2

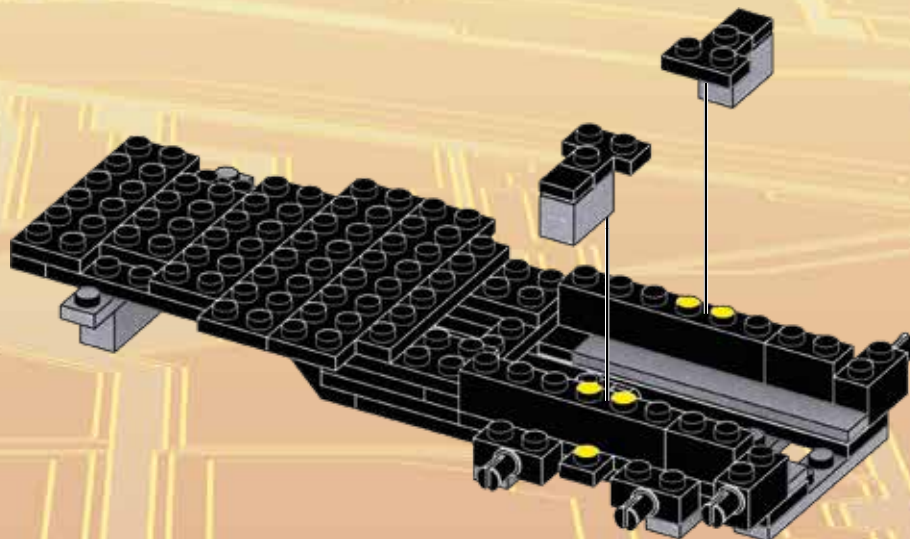

9

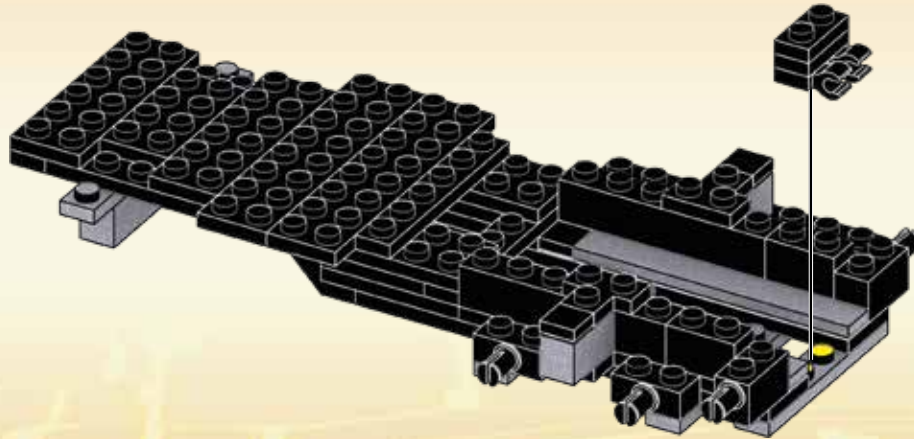

10

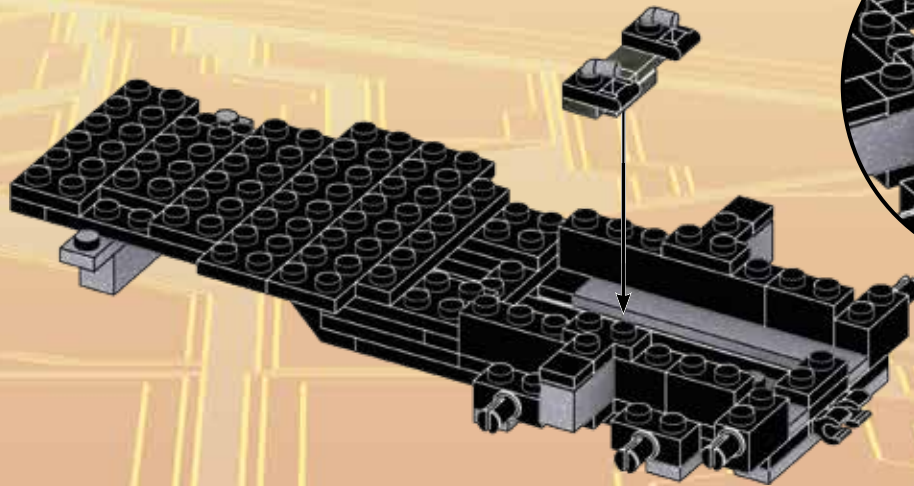
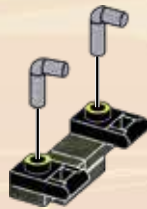

11



1X

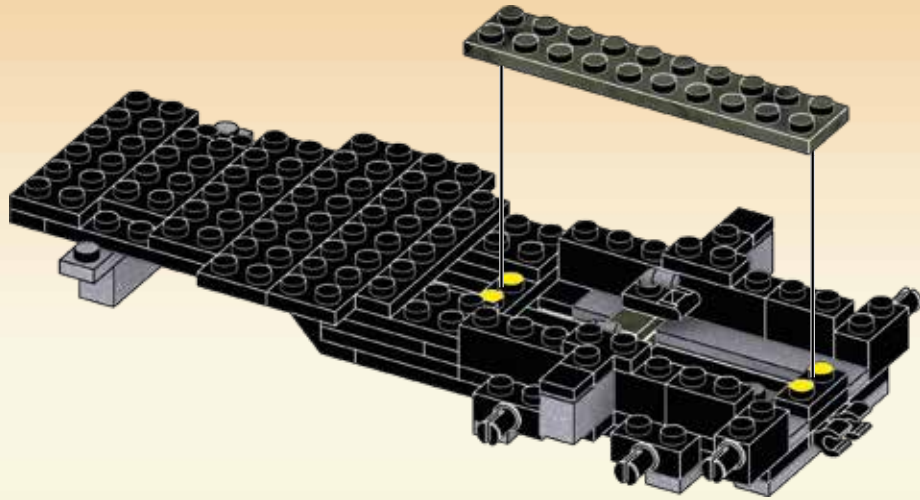

12



1X



1X



1X

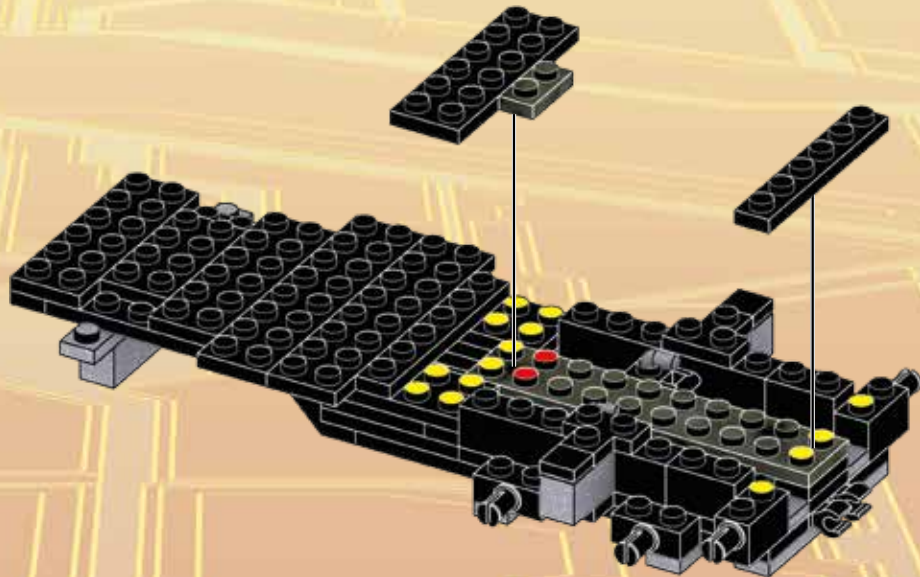



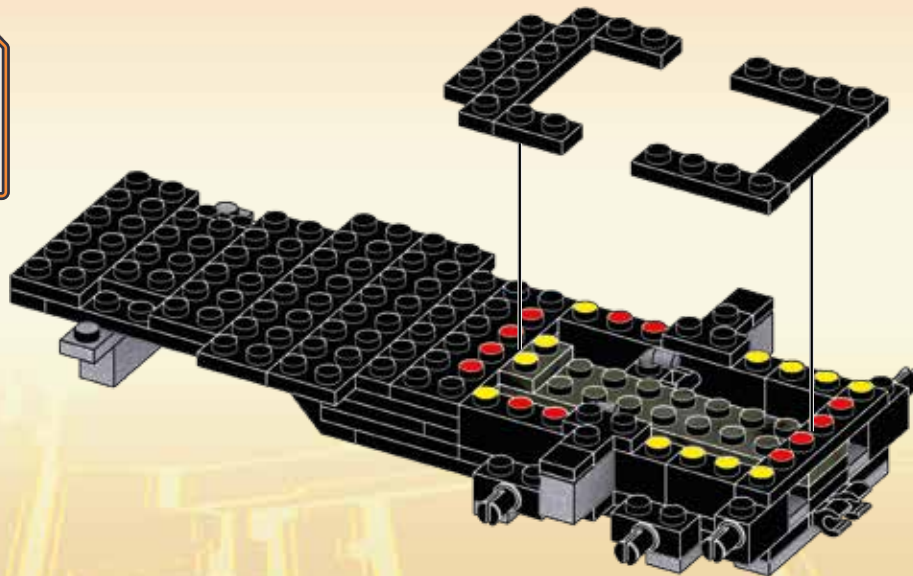

13

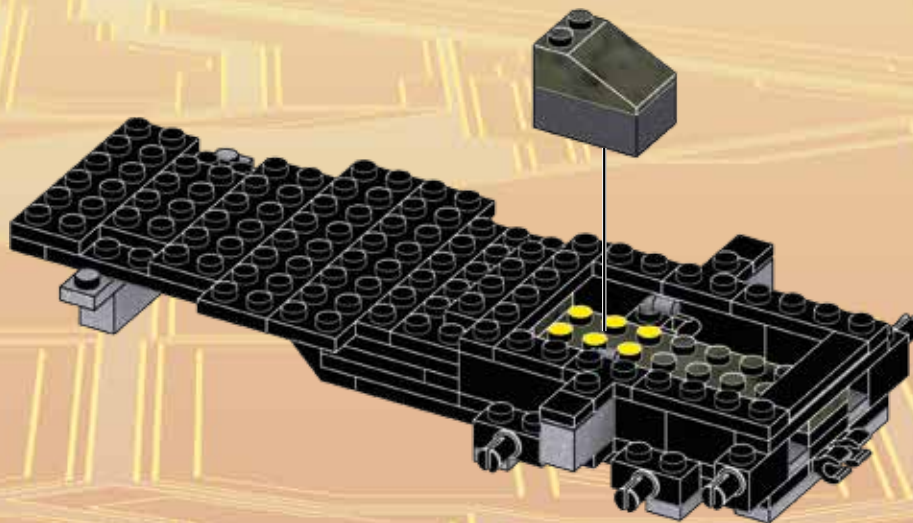

14



15

- 2X 
- 2X 
- 4X 
- 4X 

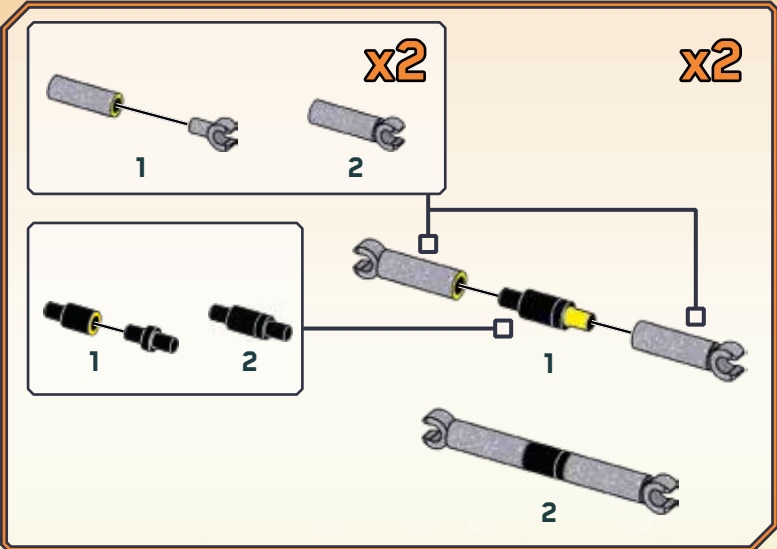
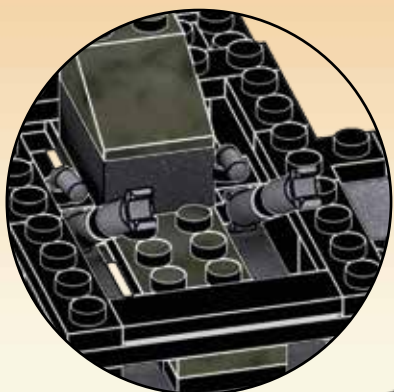

16

- 8X 
- 2X 
- 4X 

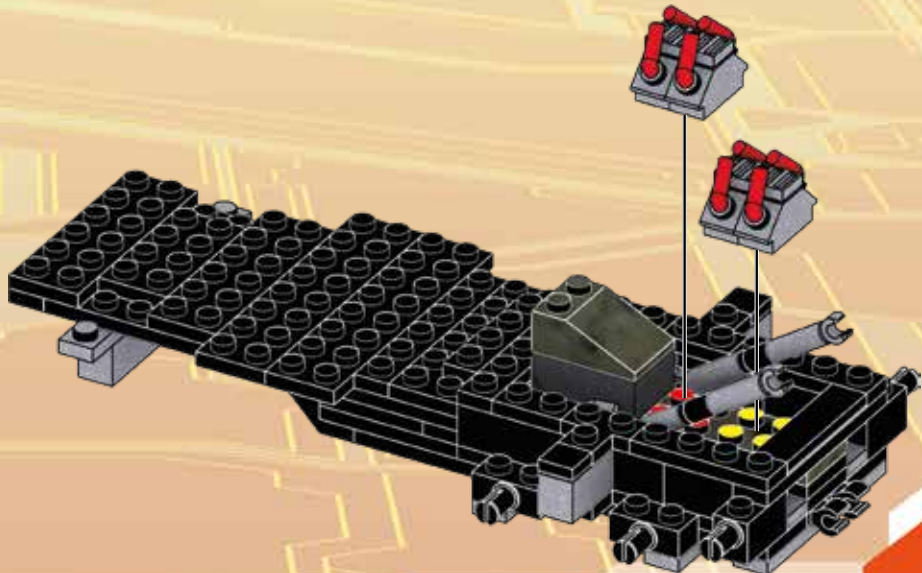

17



2X



2X



2X

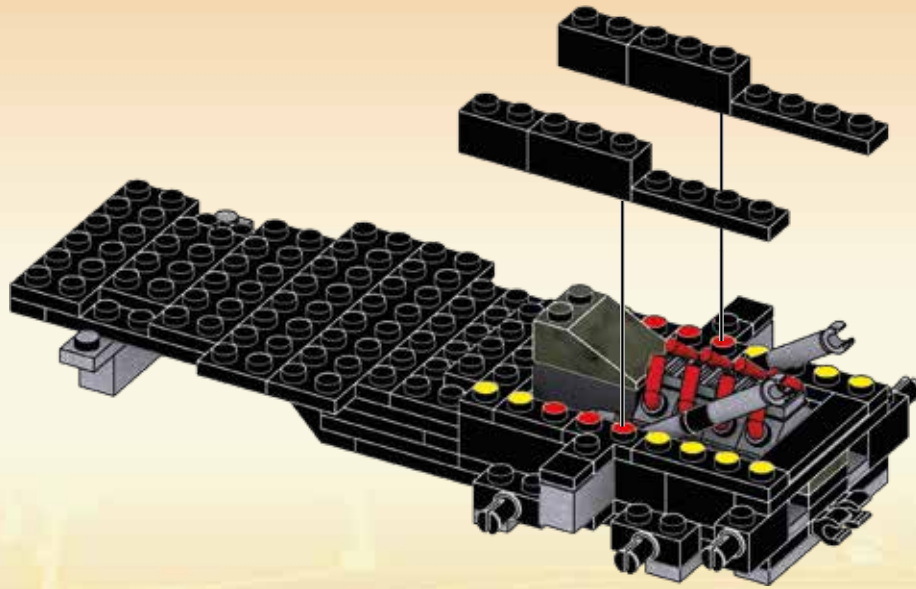

18



2X



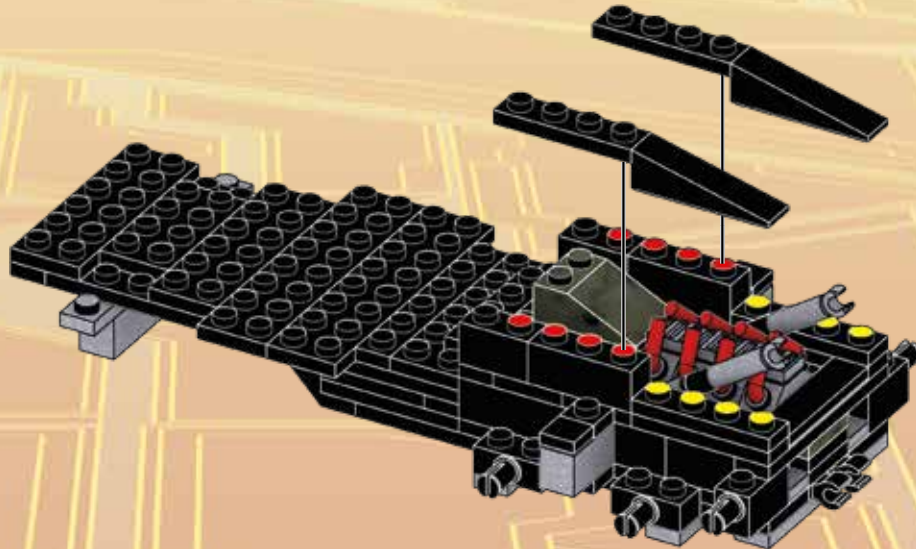

2X



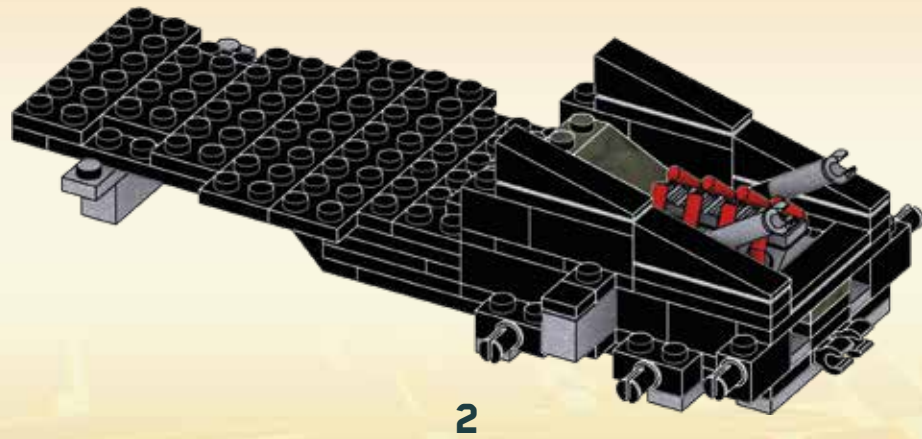
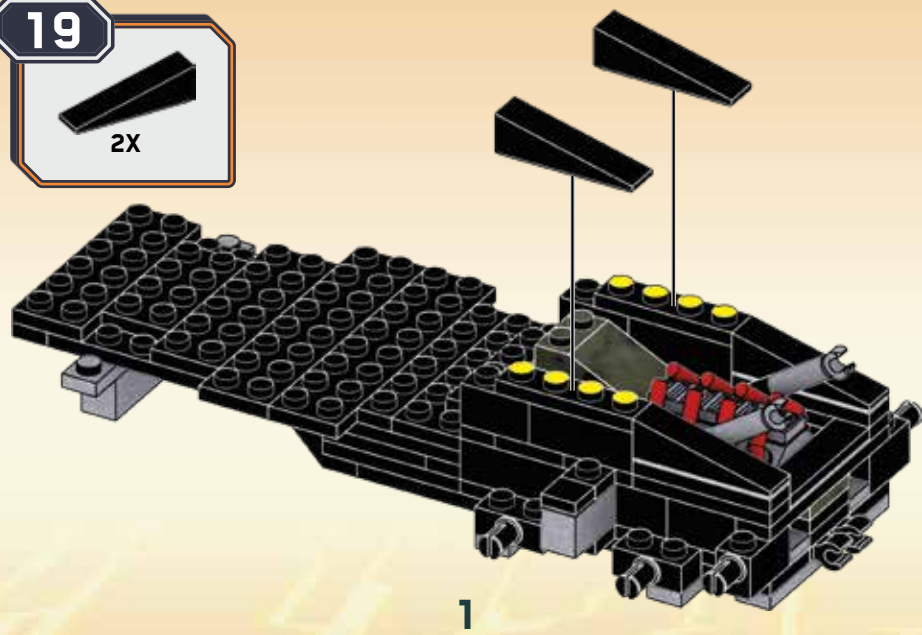

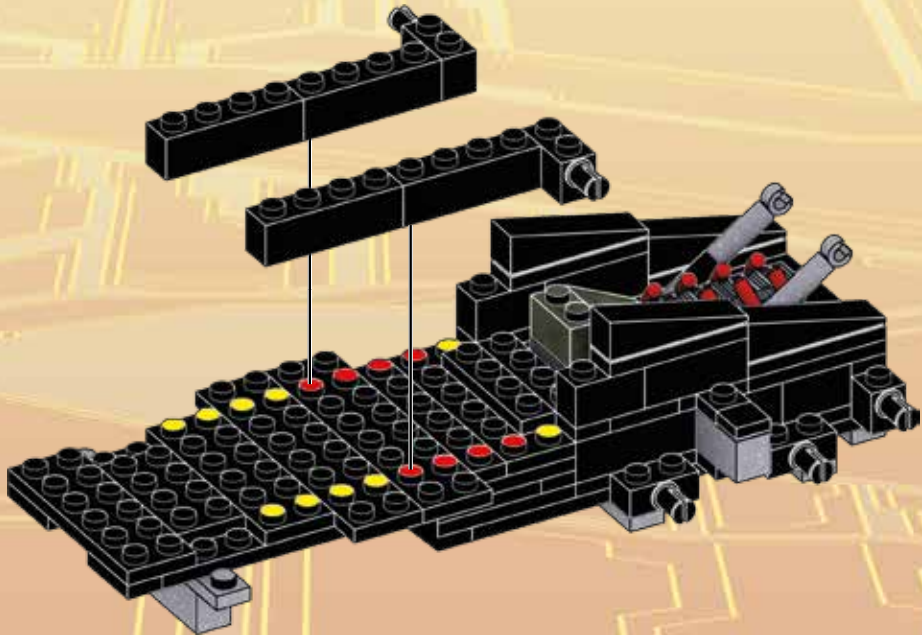

**19**  
2X



**20**  
2X      4X



## 21

- 1X 
- 1X 
- 2X 
- 1X 
- 1X 

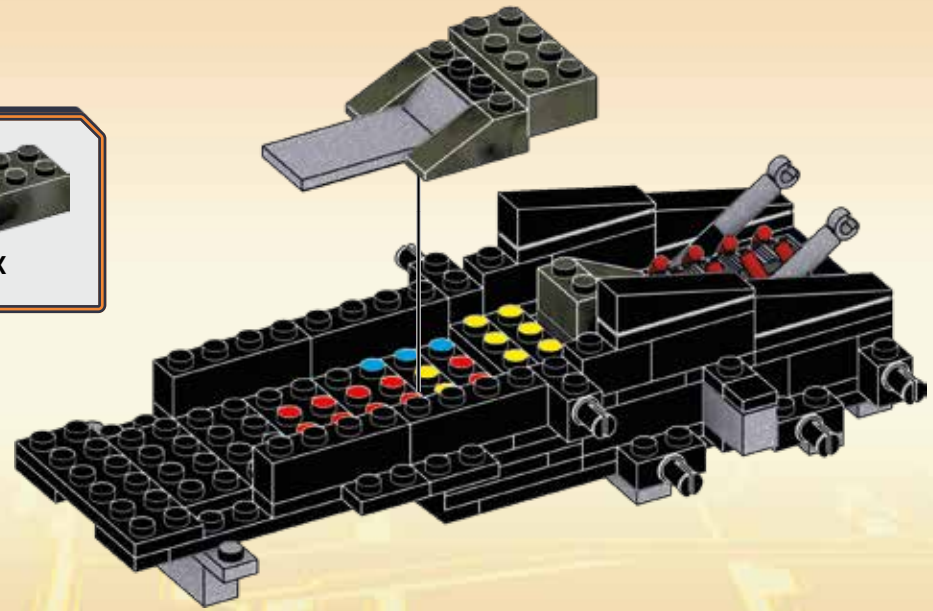

## 22

- 2X 
- 2X 
- 2X 
- 2X 
- 2X 

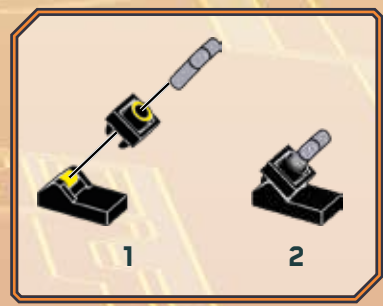
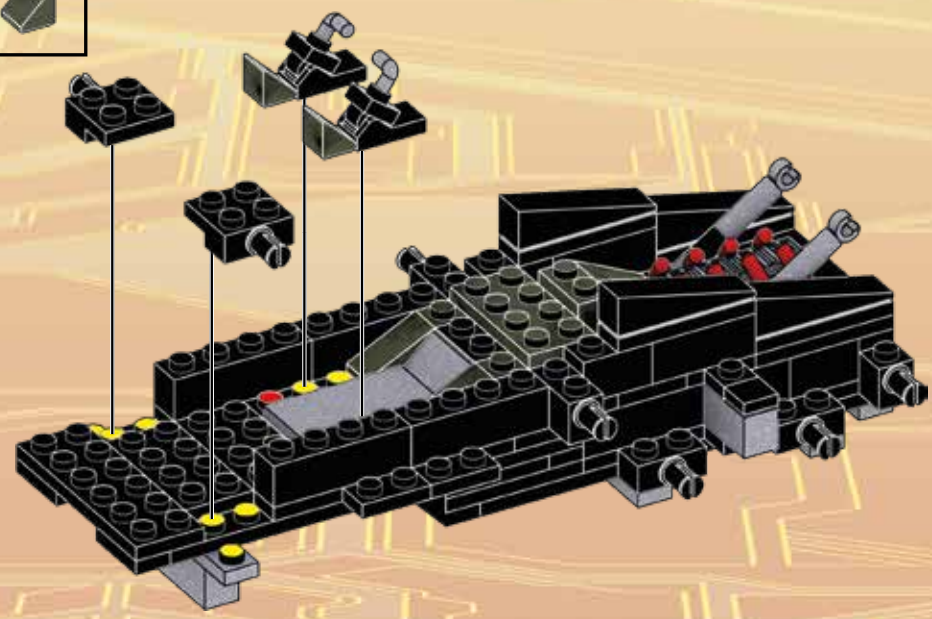



23

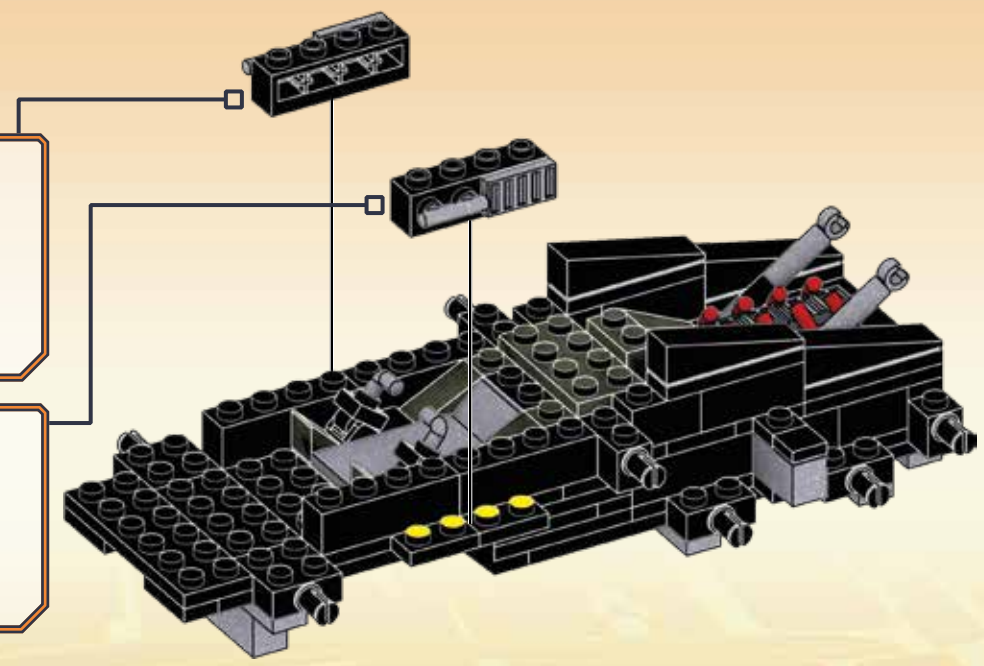
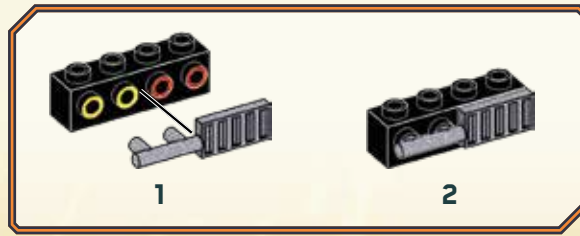
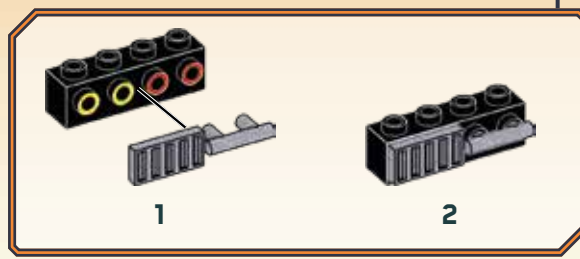

24

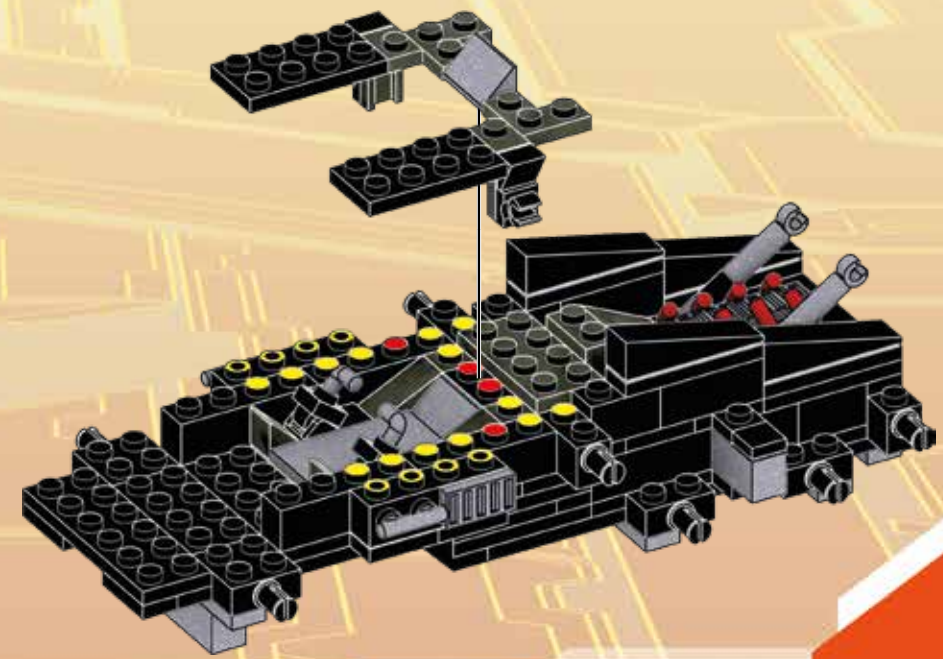
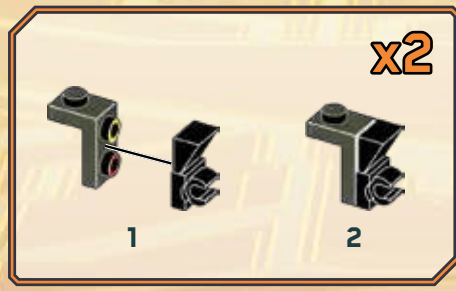

25

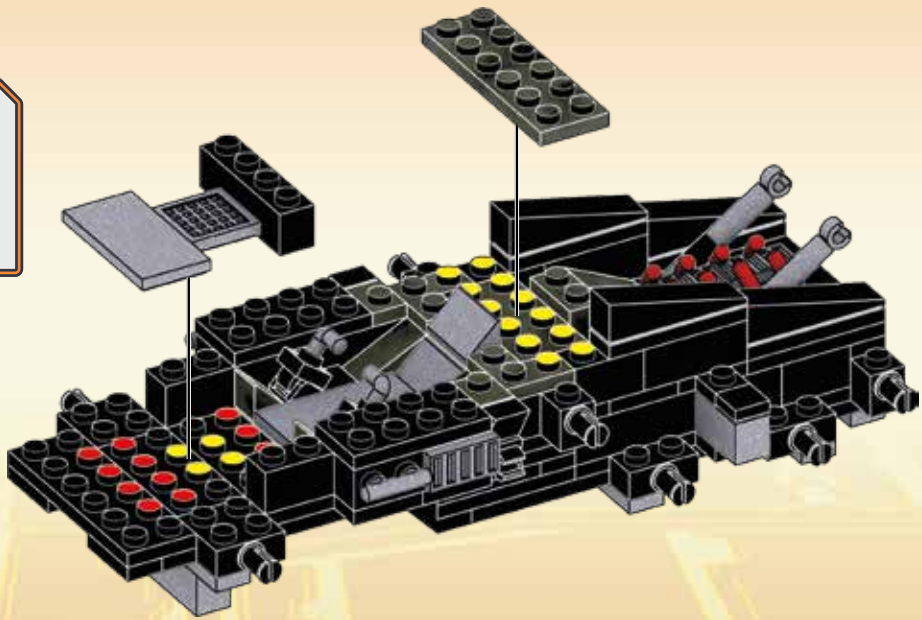

26

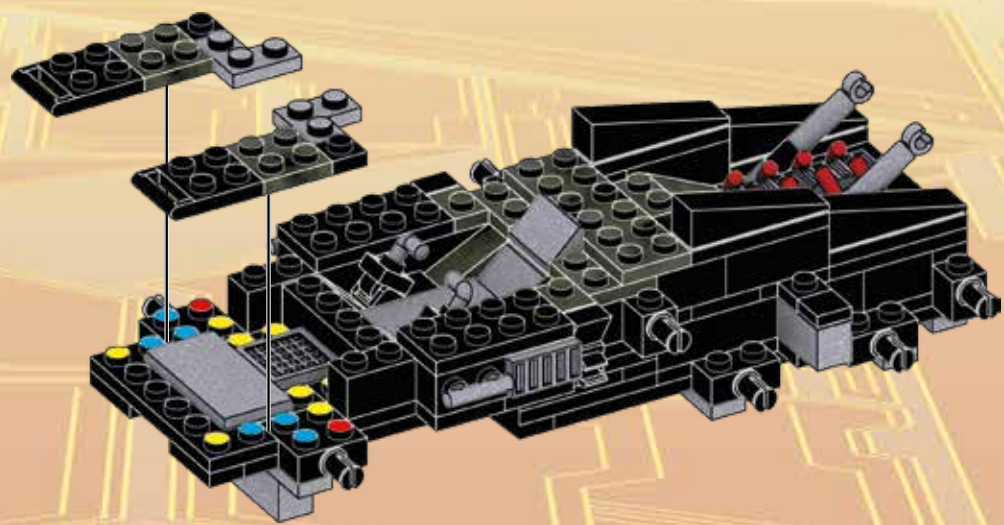

27

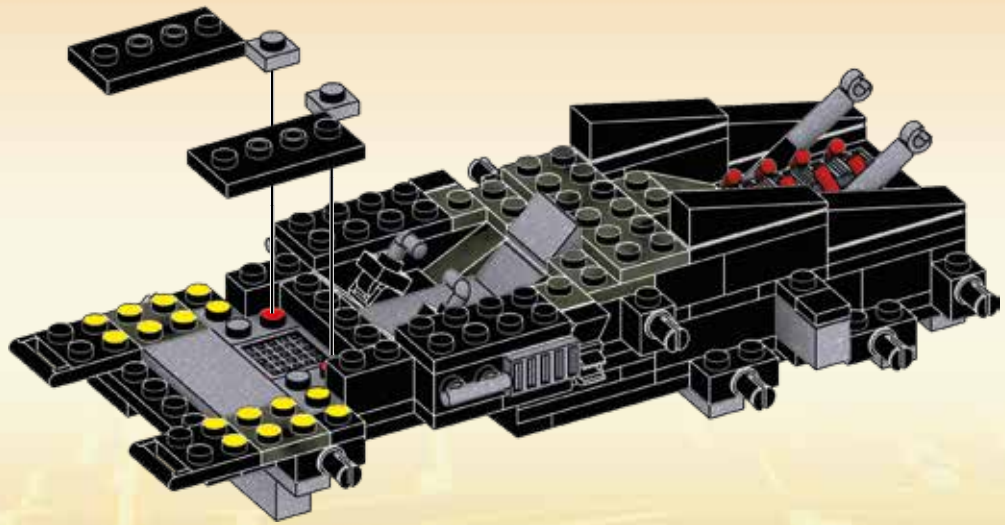

28

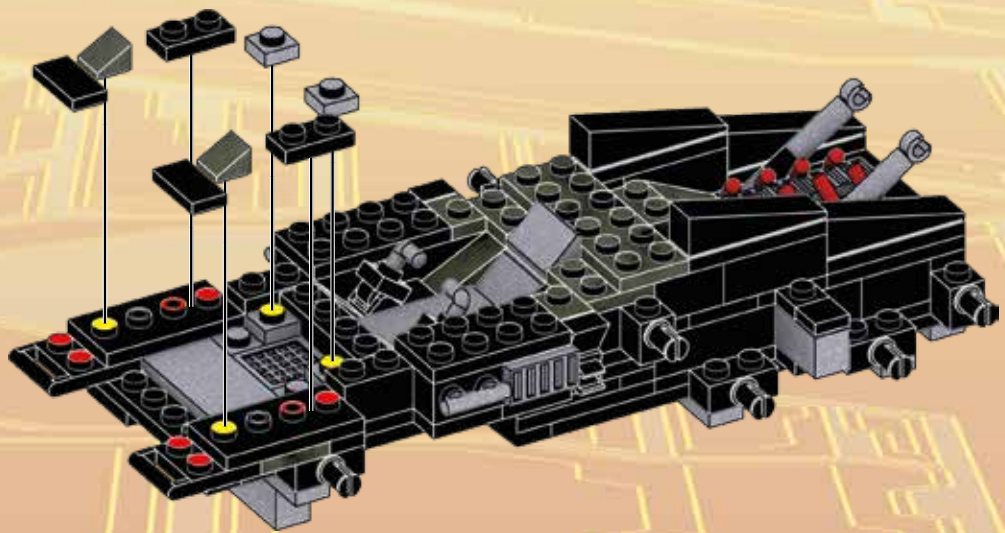

**29**

- 2X 
- 2X 
- 2X 

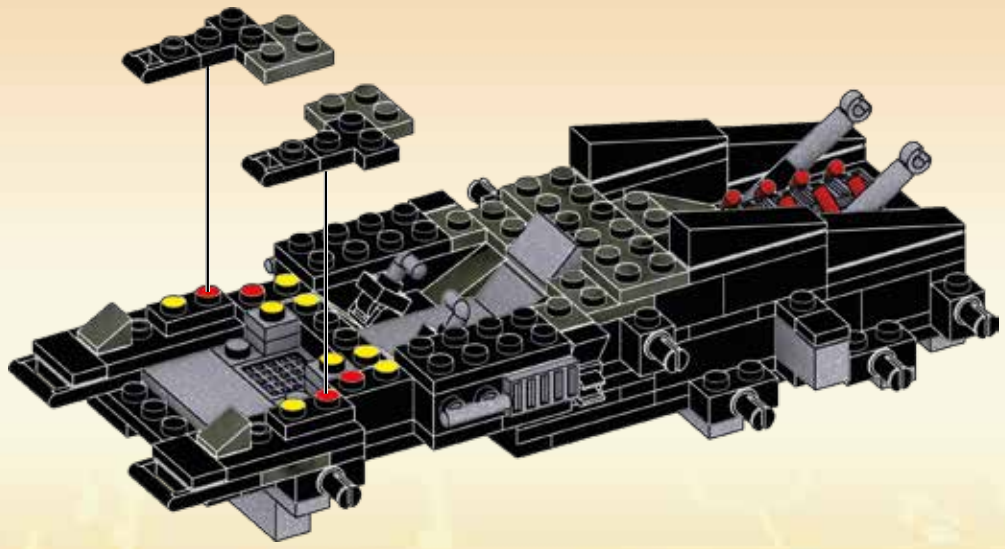

**30**

- 2X 
- 1X 
- 2X 
- 2X 
- 4X 

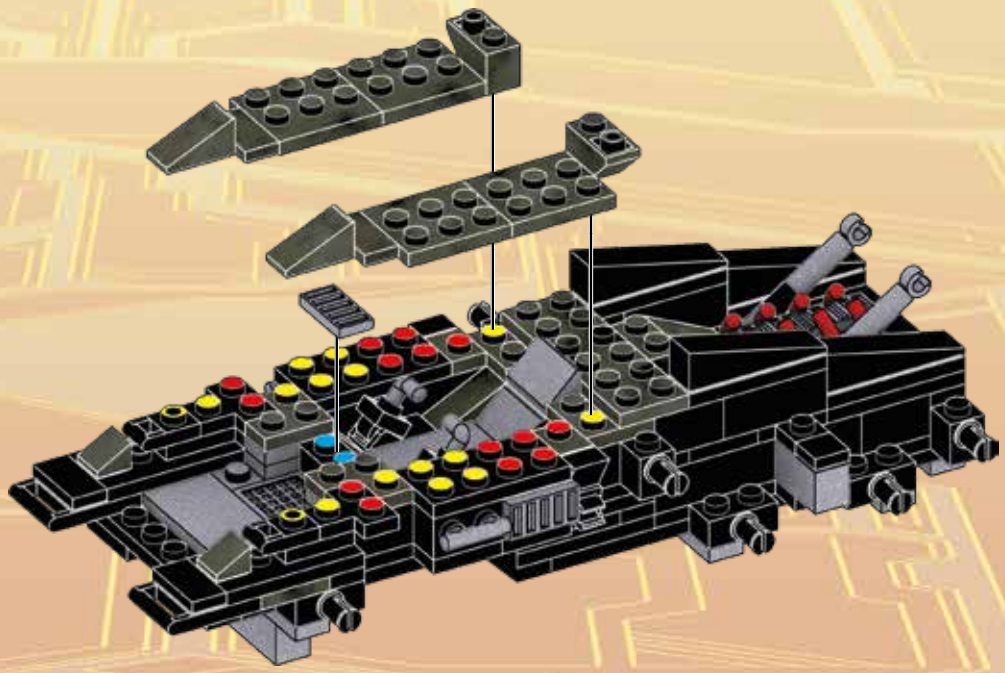

31



2X



2X



2X



4X



2X

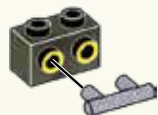
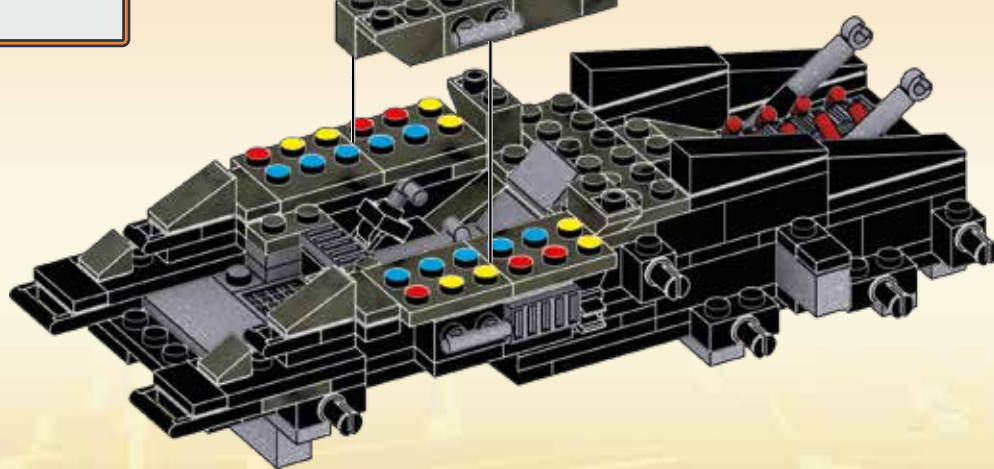

1



2

x2

32



1X

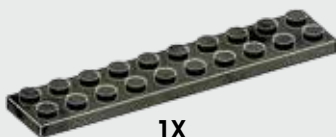

1X

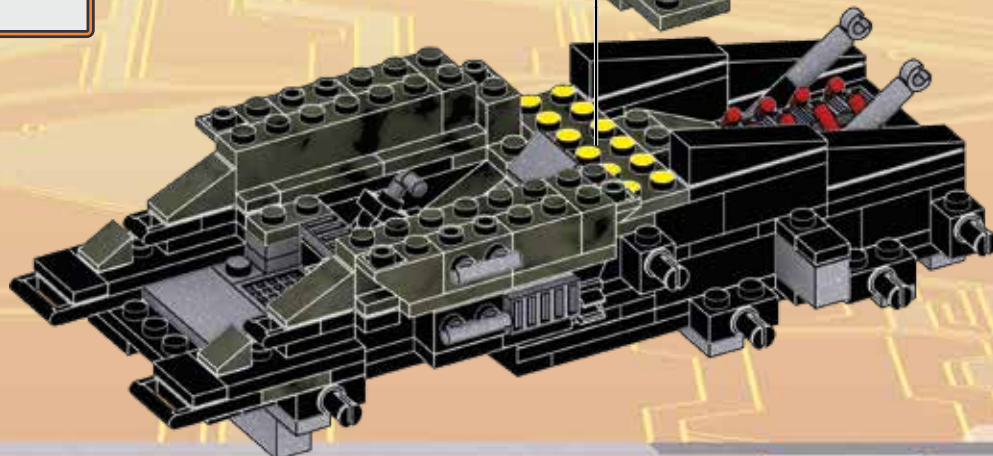
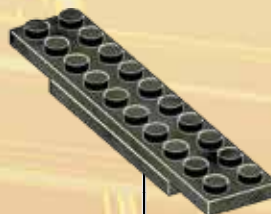

33

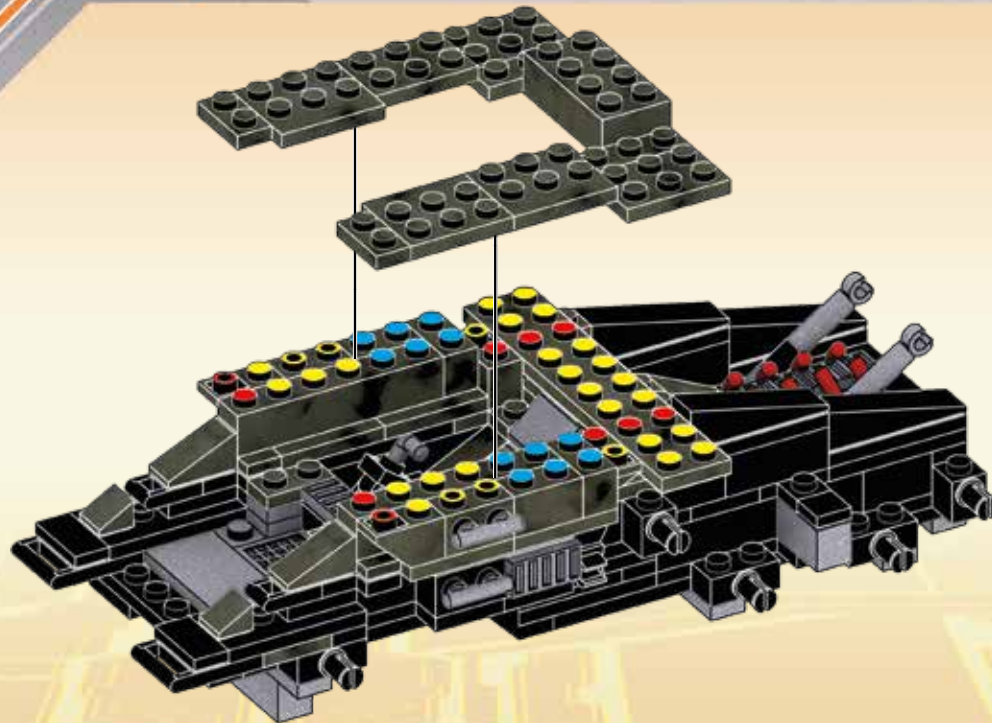
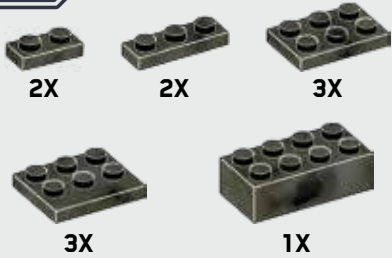

34

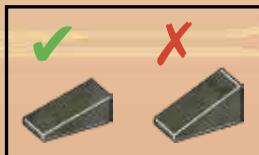
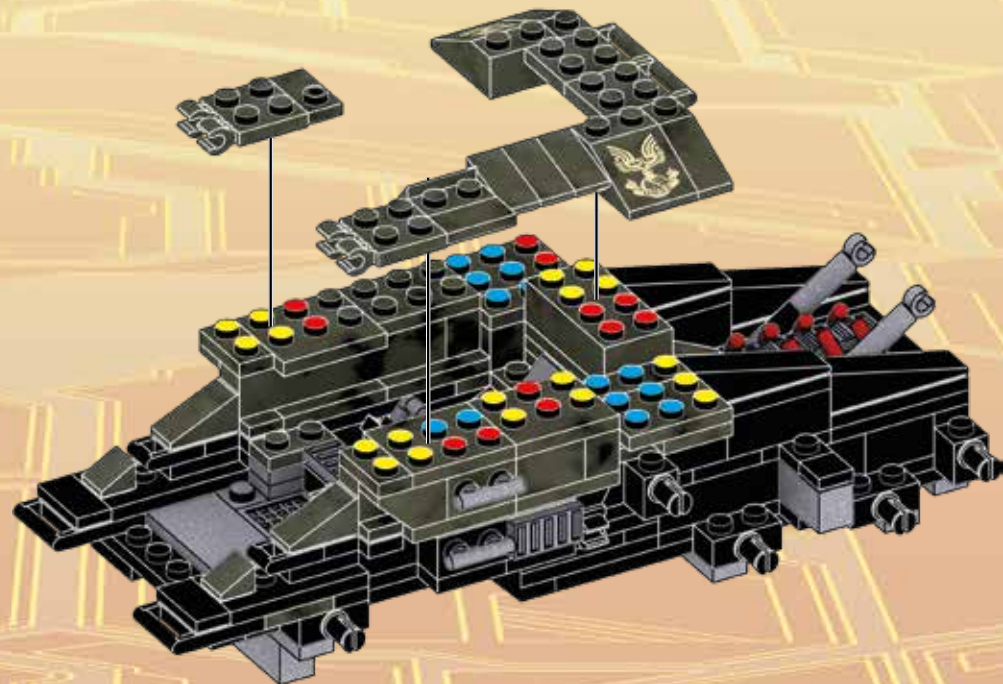

35

1X 2X 1X 2X  
2X 1X

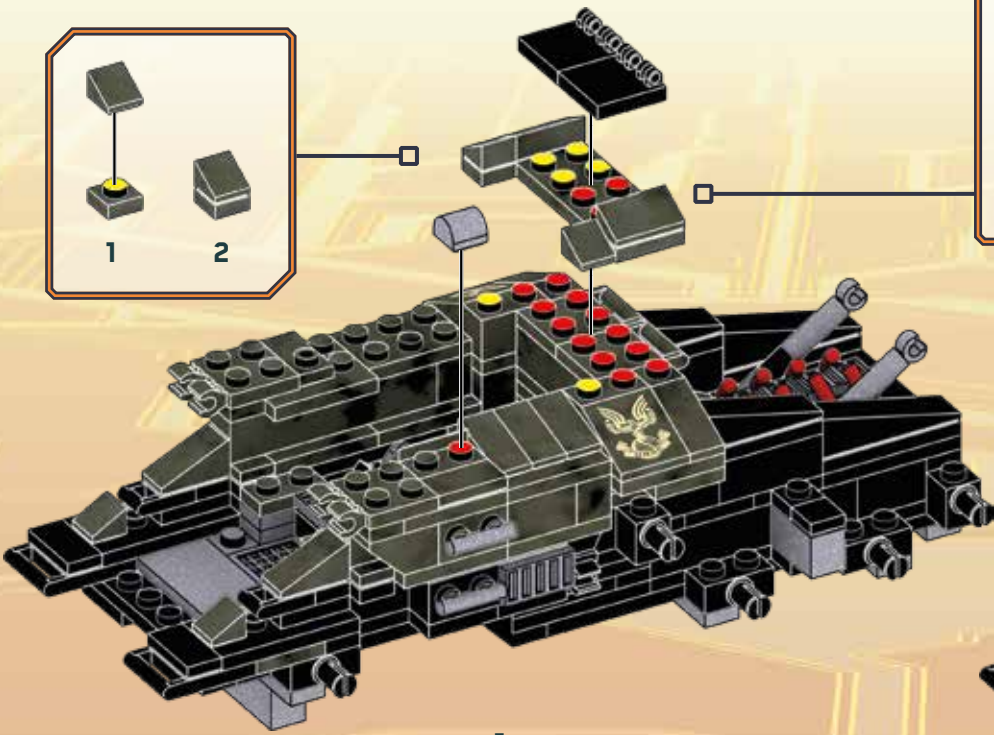
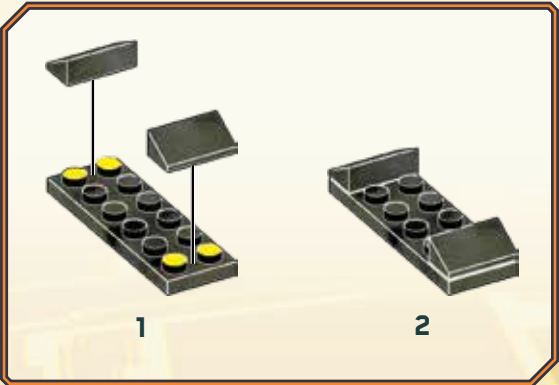

1

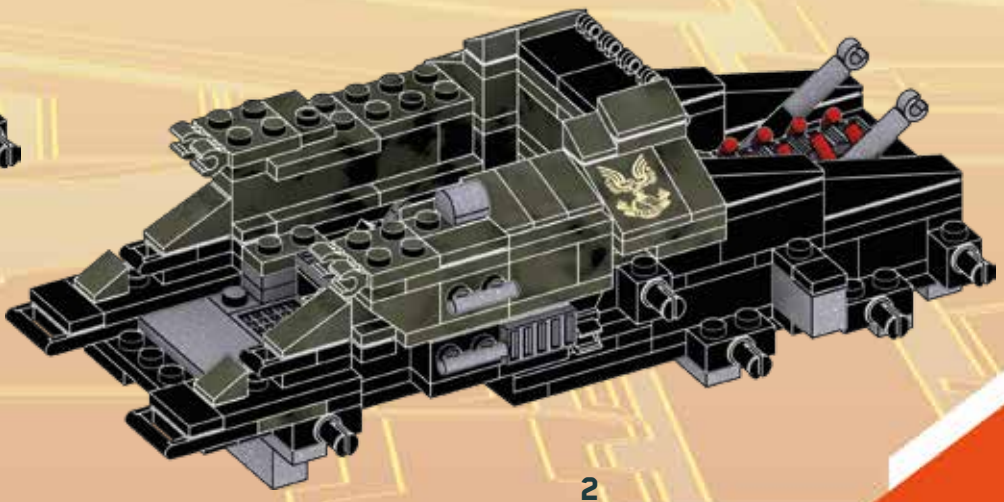

2

# MEGA CONSTRUX™

Build Beyond™

Au-delà de la construction !

¡Construye sin límites!

Mais do que Construção!

Costruisci oltre ogni limite!

Es gibt keine Grenzen!

Więcej niż budowanie!

Meer dan alleen bouwen!

Больше, чем конструктор!

Χτίσε έναν ολόκληρο κόσμο!

Hayallerini İnşa Et!

لنبني .. وأكثر!



[megaconstrux.com](http://megaconstrux.com)

