

2

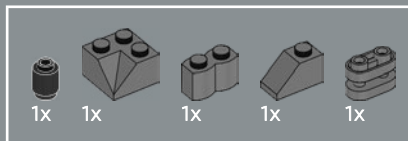

3

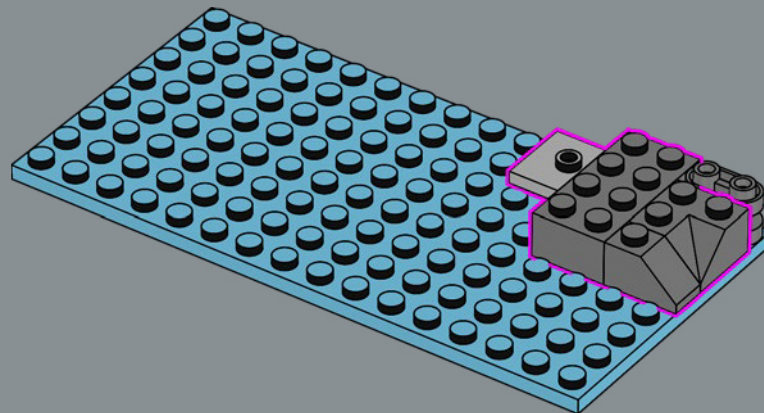

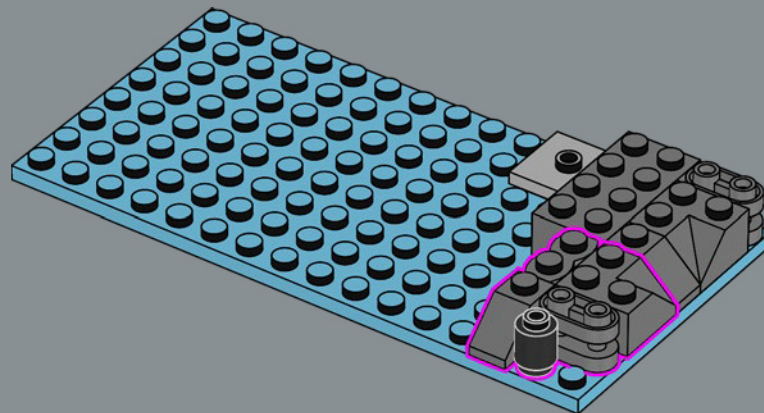
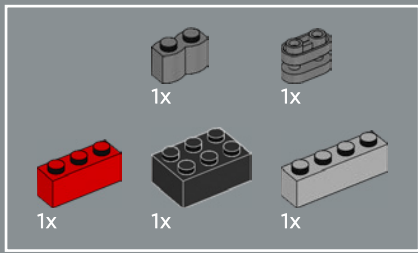

4

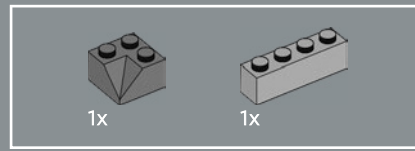
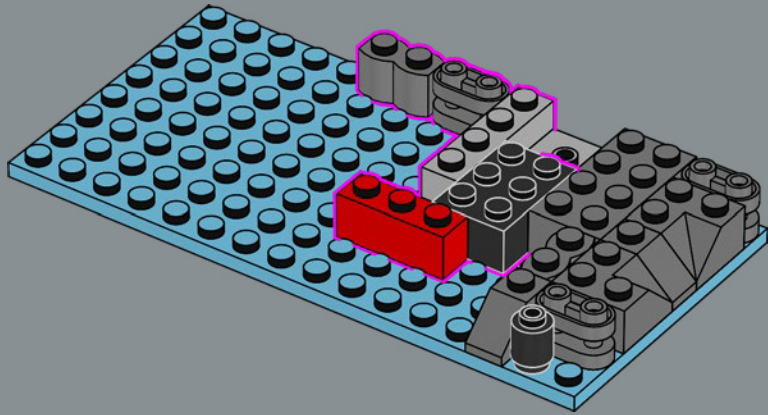

5

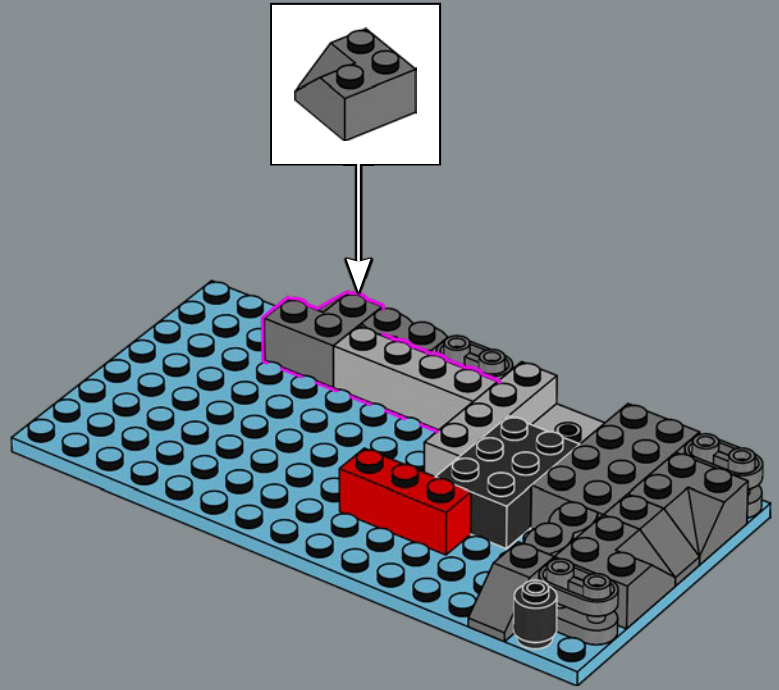

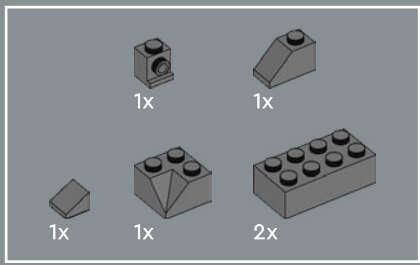

6

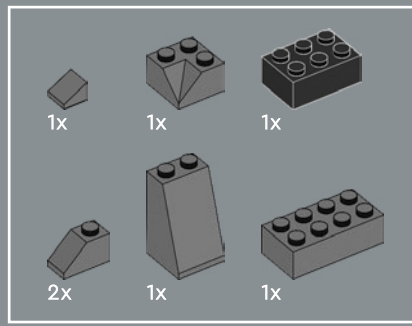
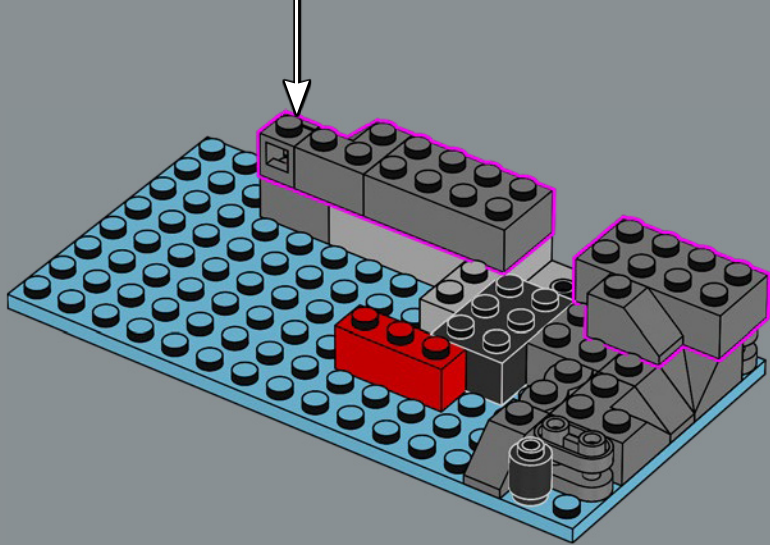
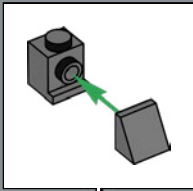

7

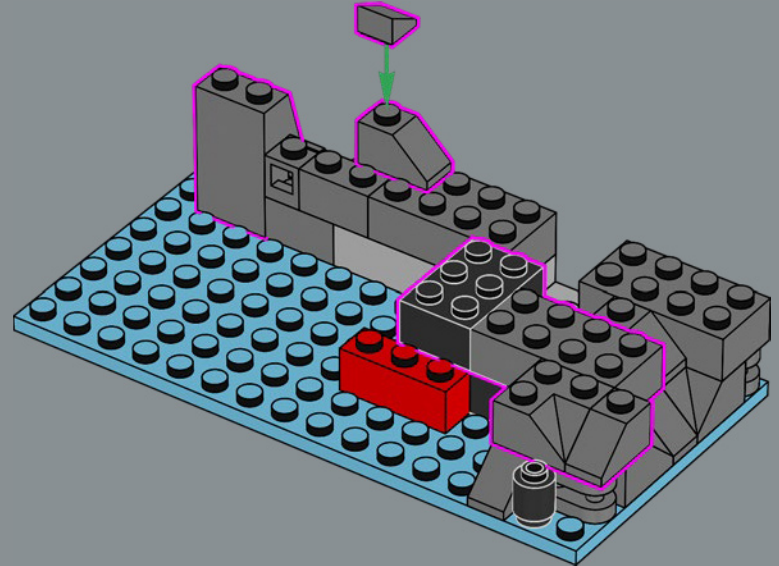

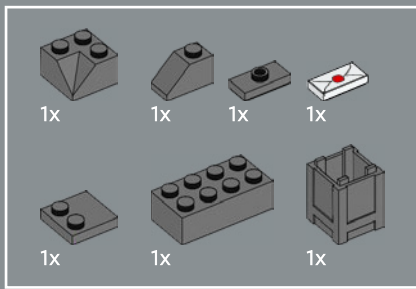

8

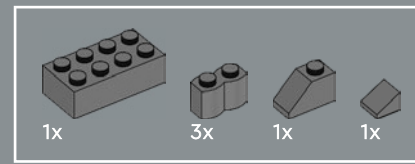
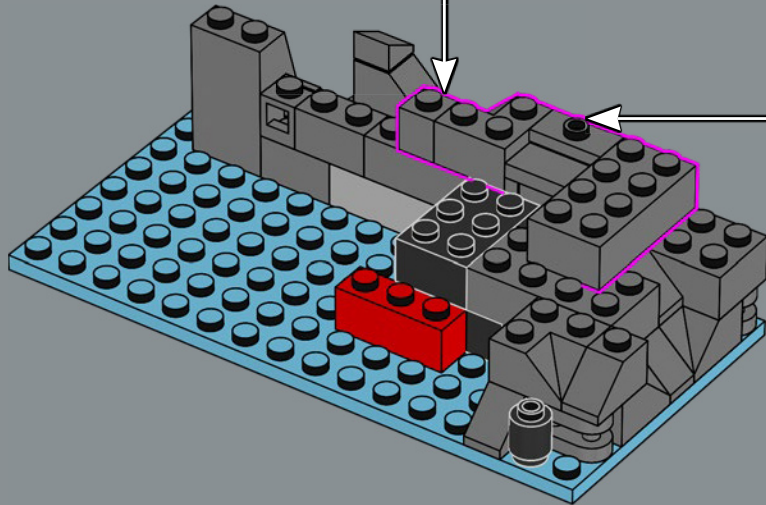
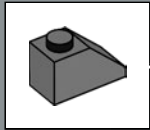
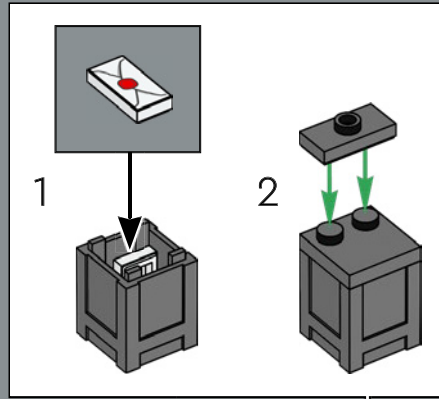

9

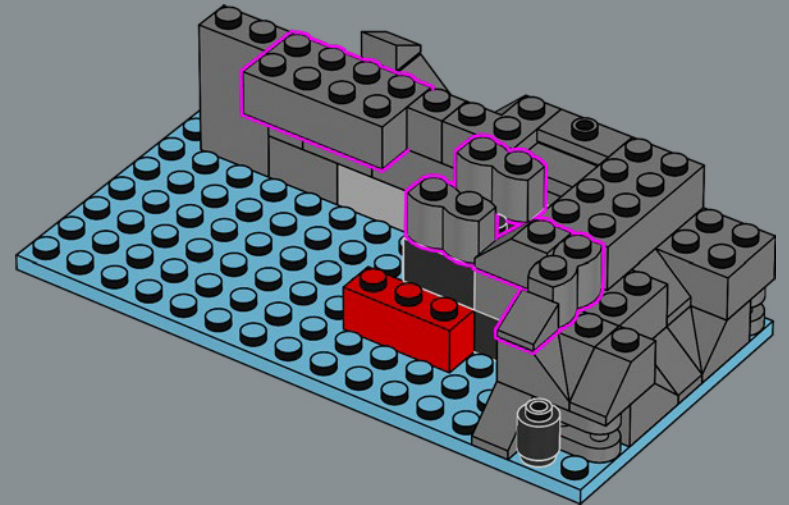

Una lettera segreta? Chi potrebbe essere il mittente? Chi può risolvere questo mistero?

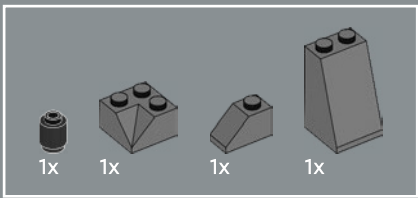

10

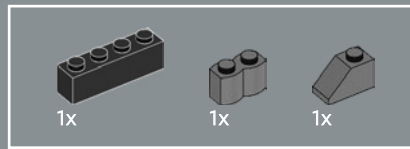
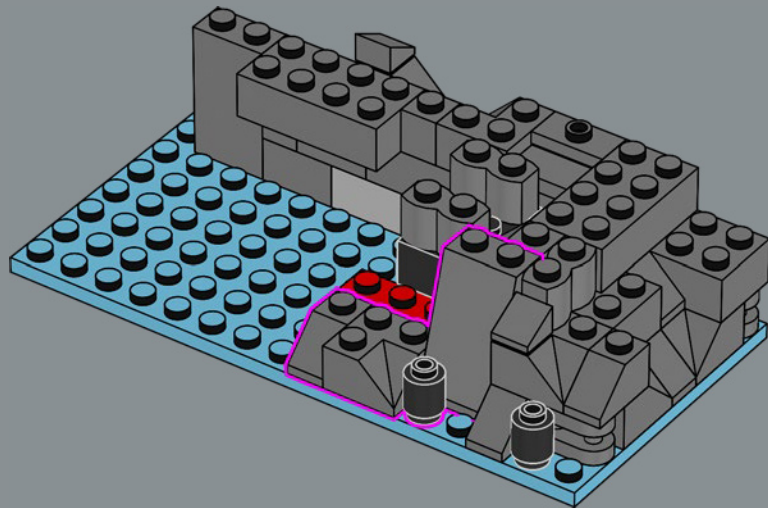

11

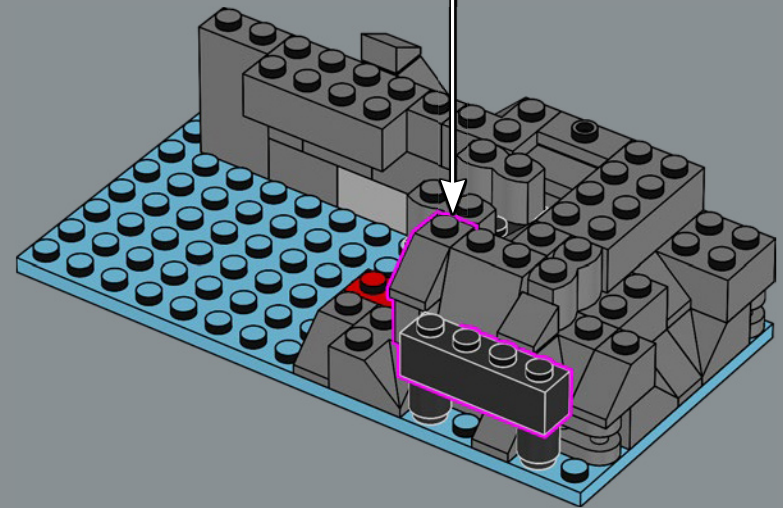
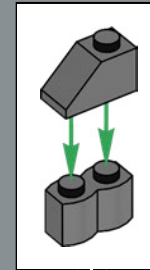

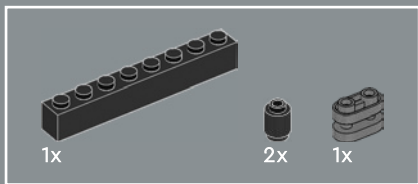

12

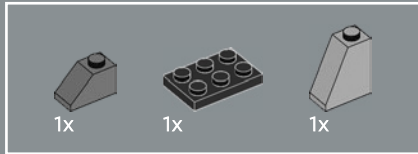
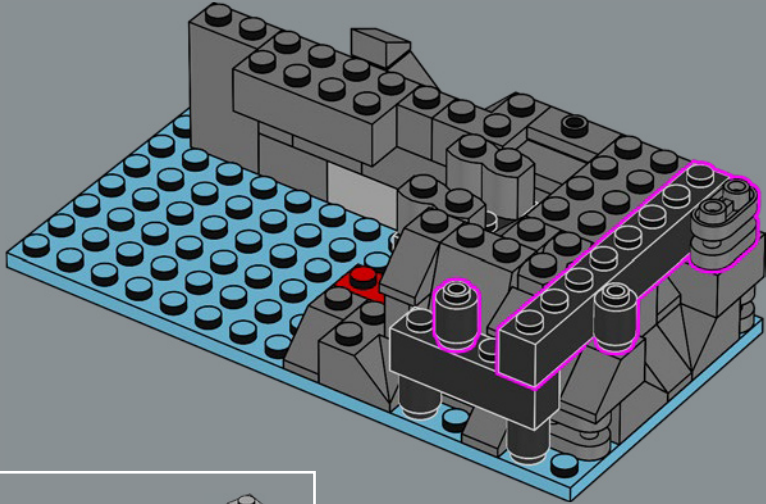

13

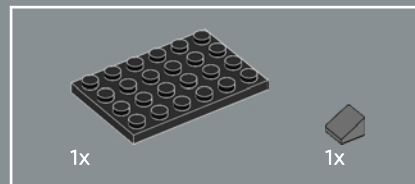
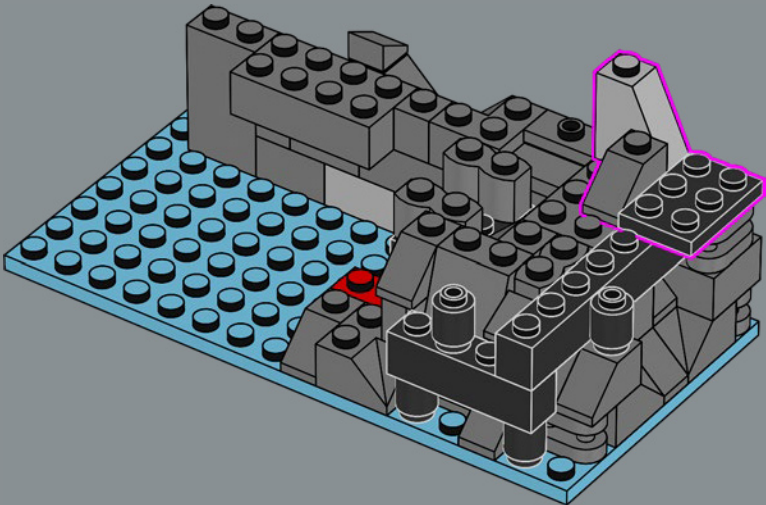

14

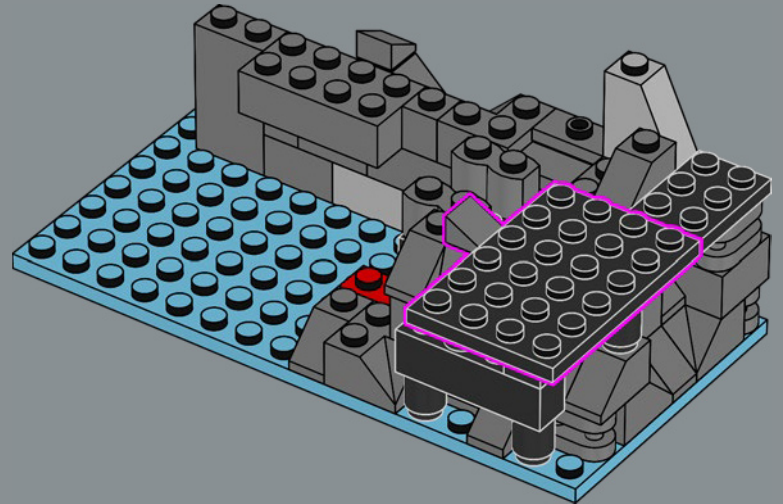

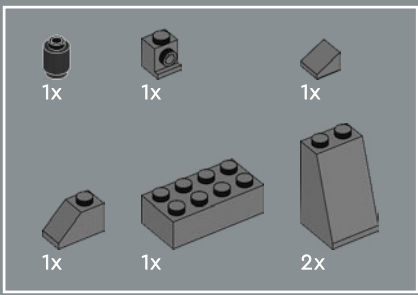

15

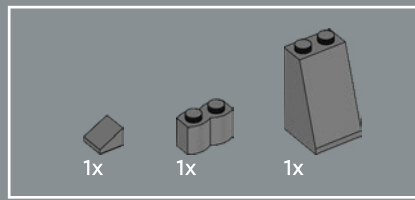
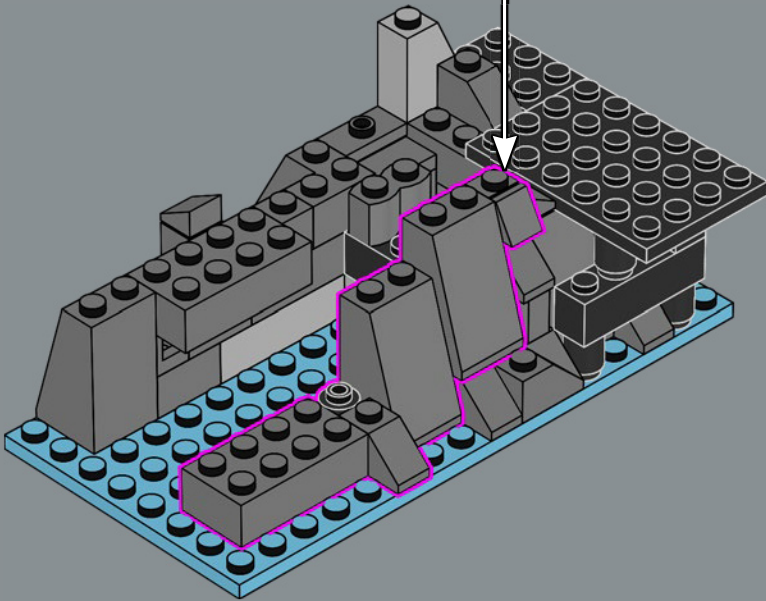
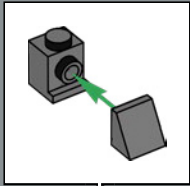

16

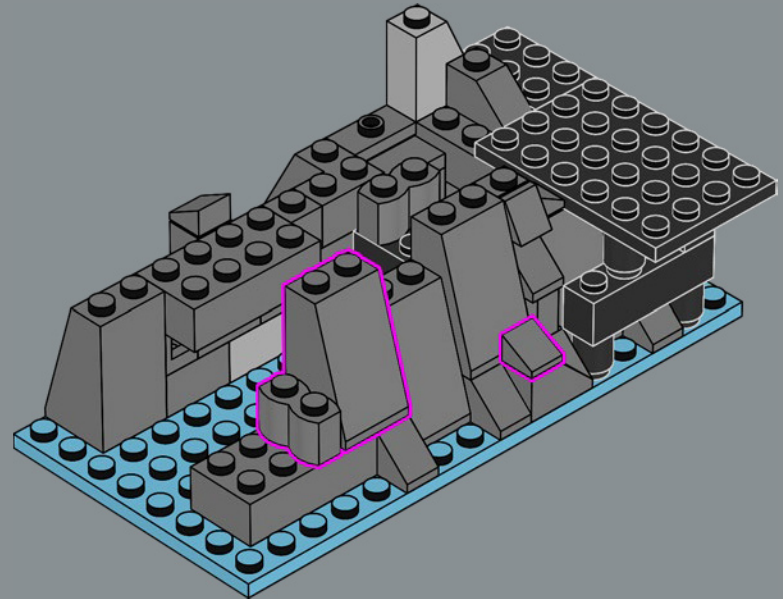

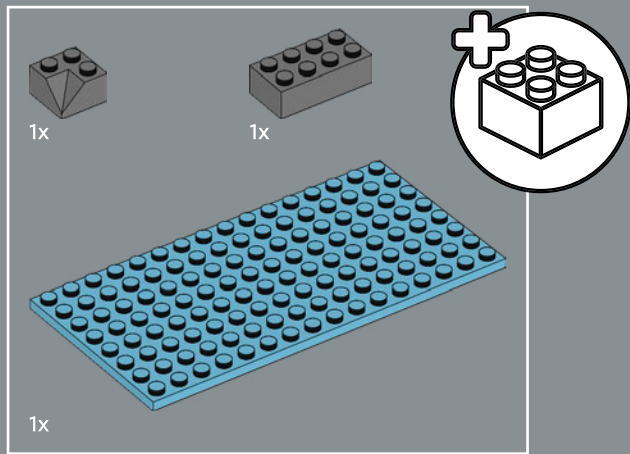

17

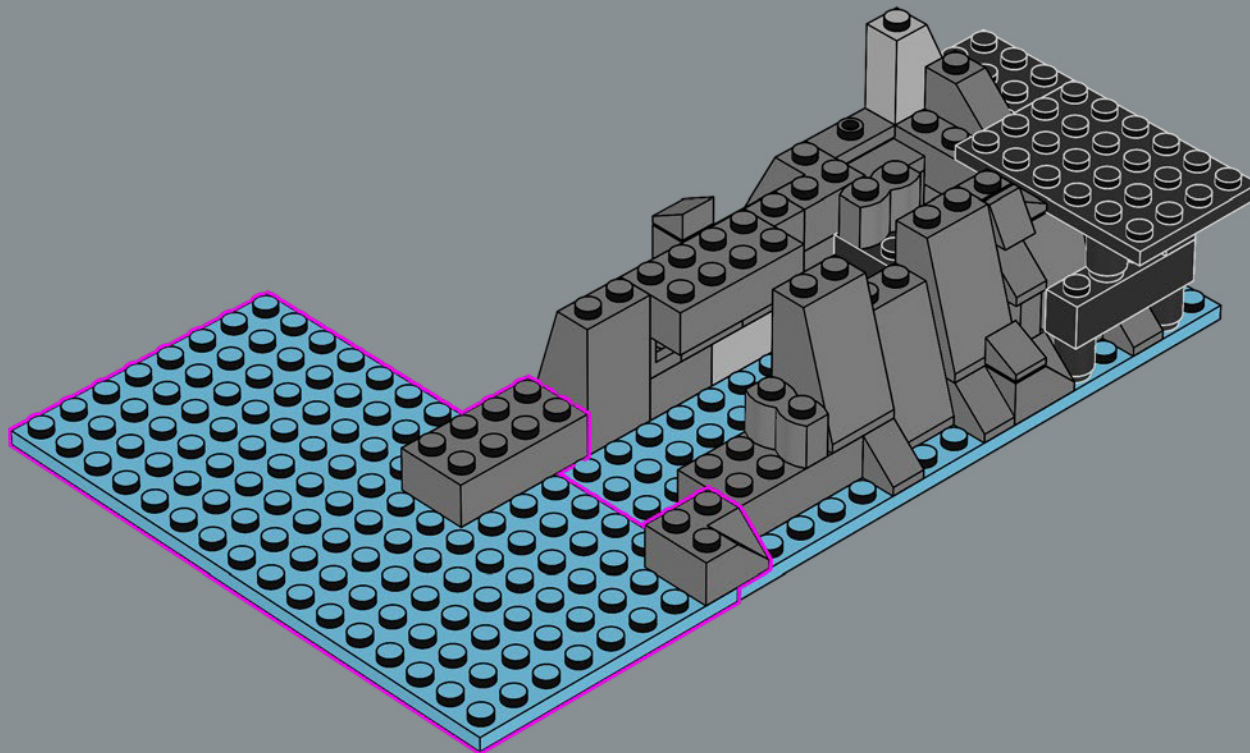

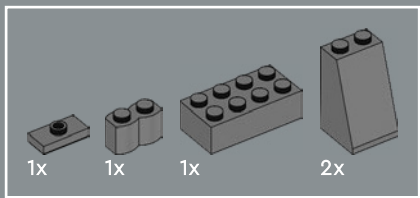

18

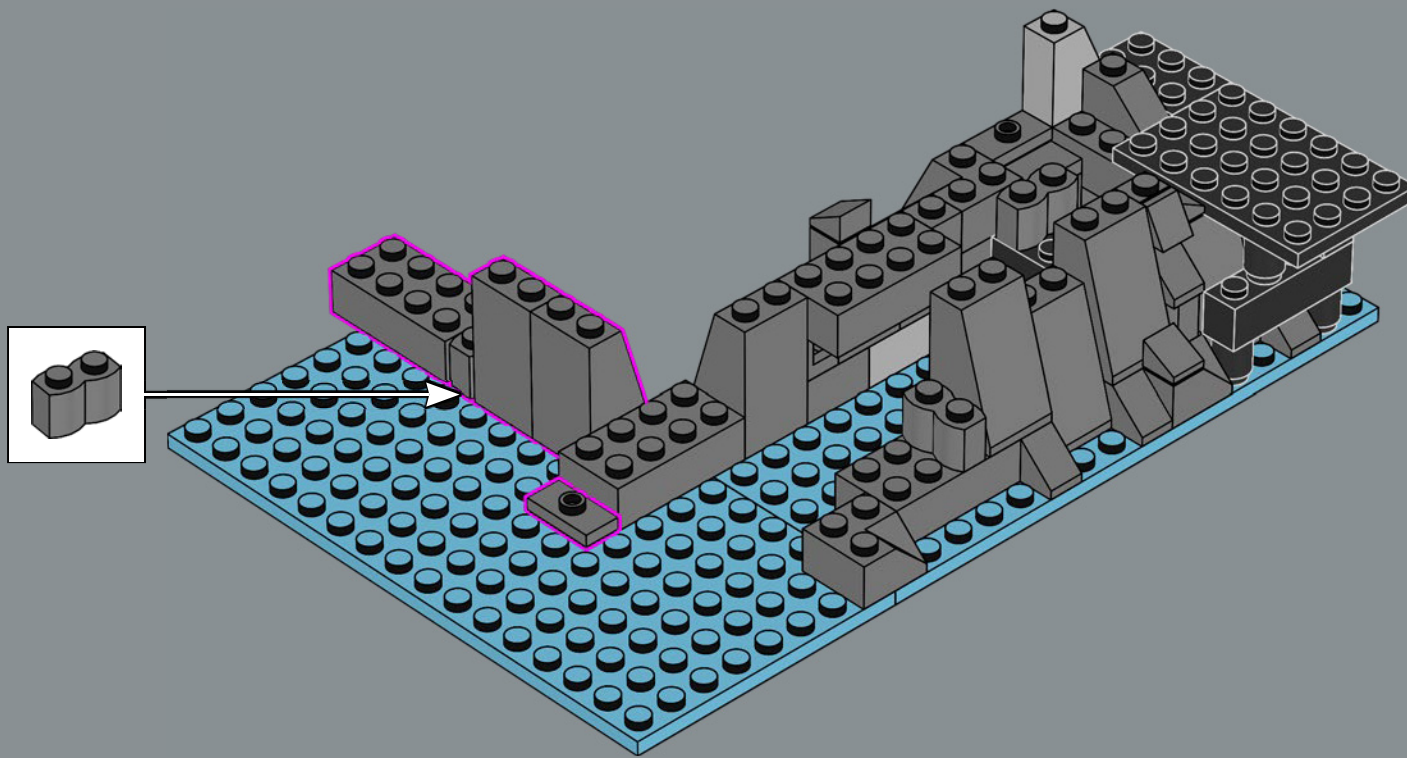

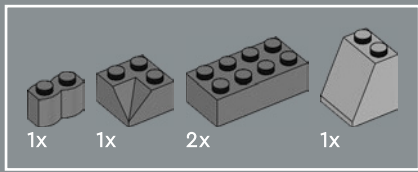

19

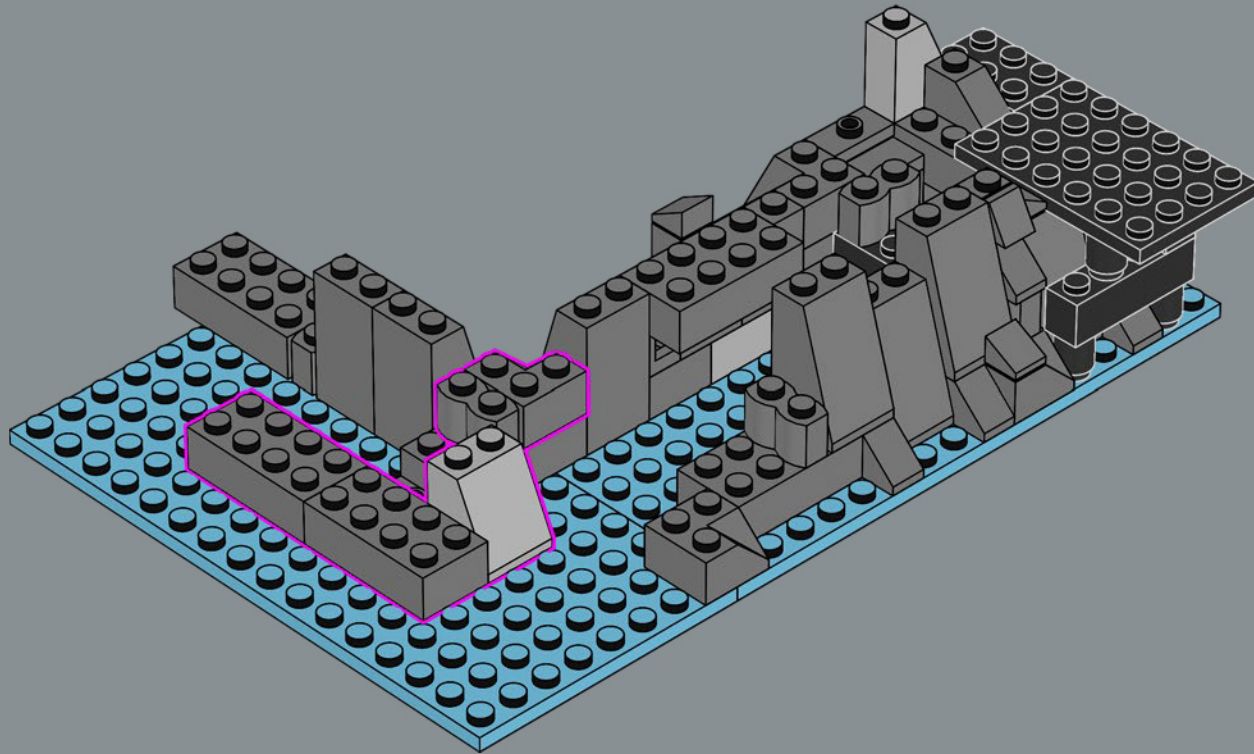

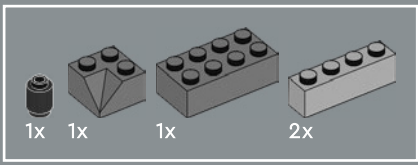

20

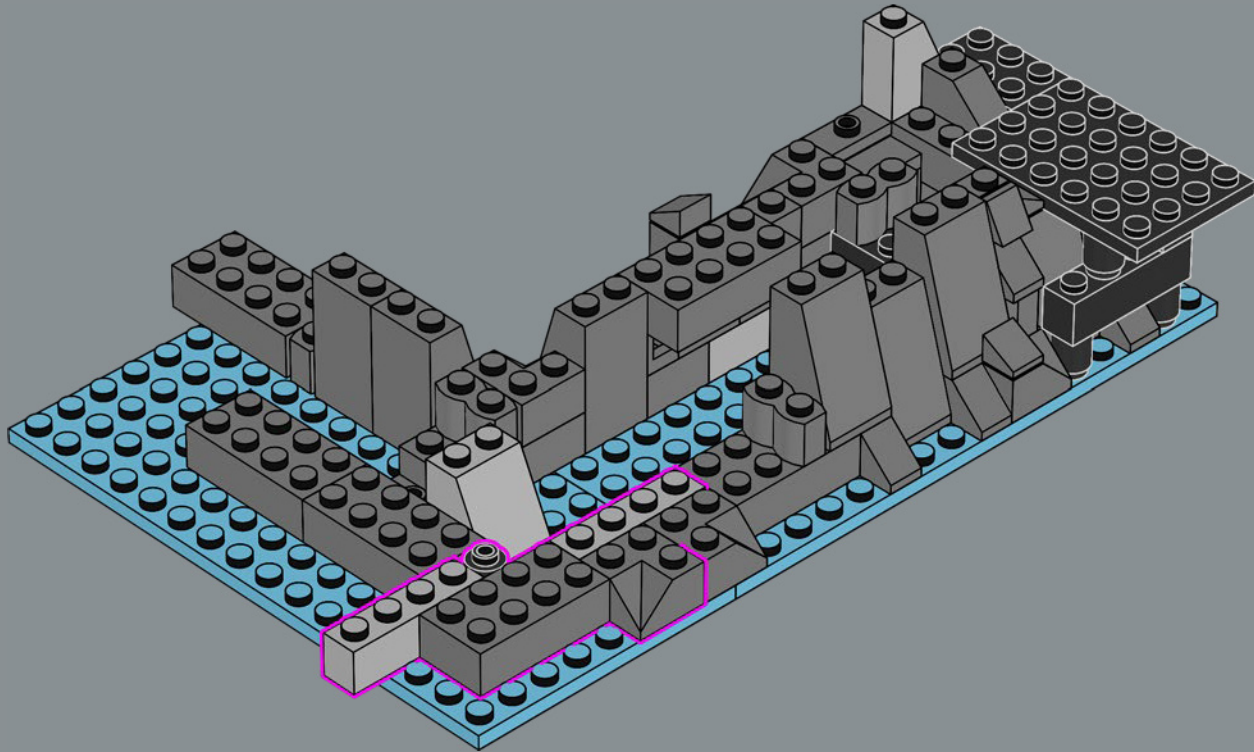

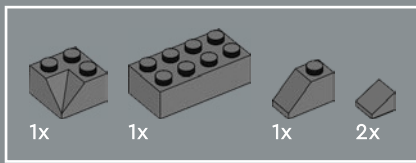

21

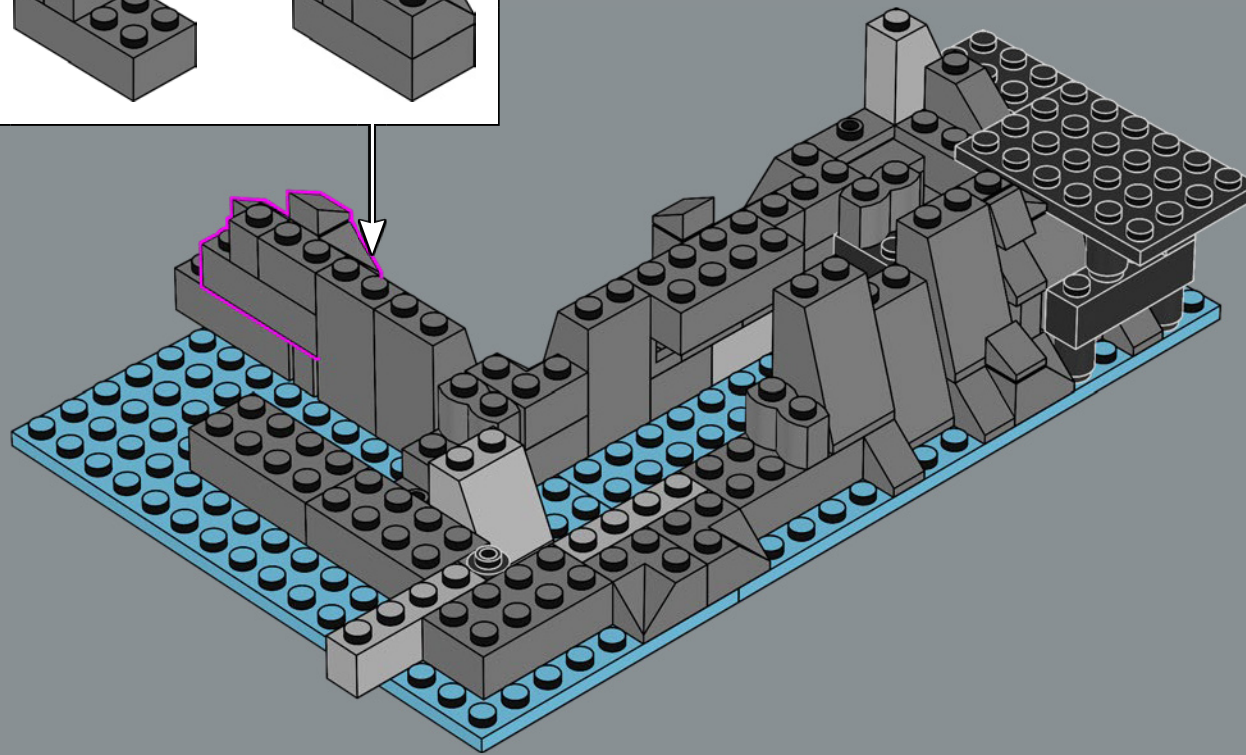
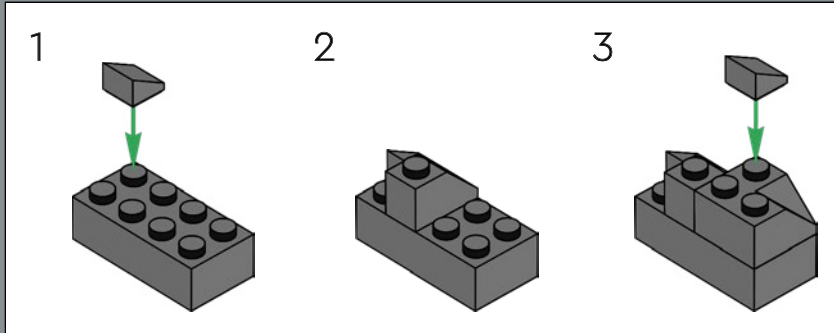

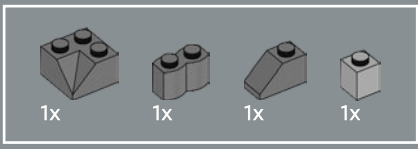

22

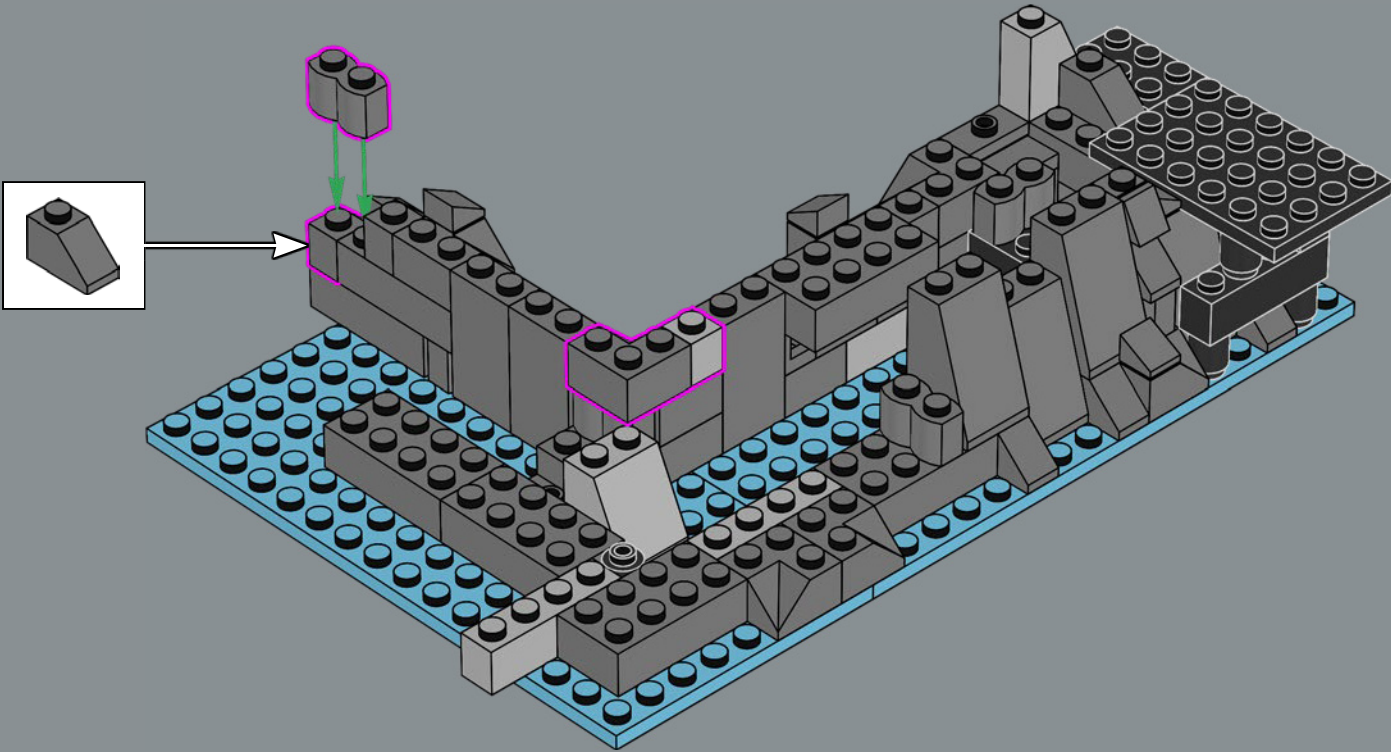

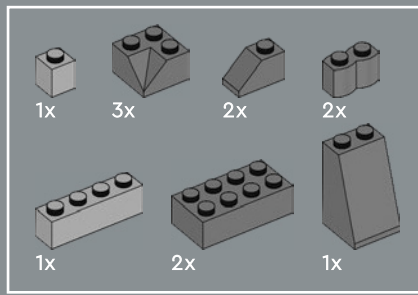

23

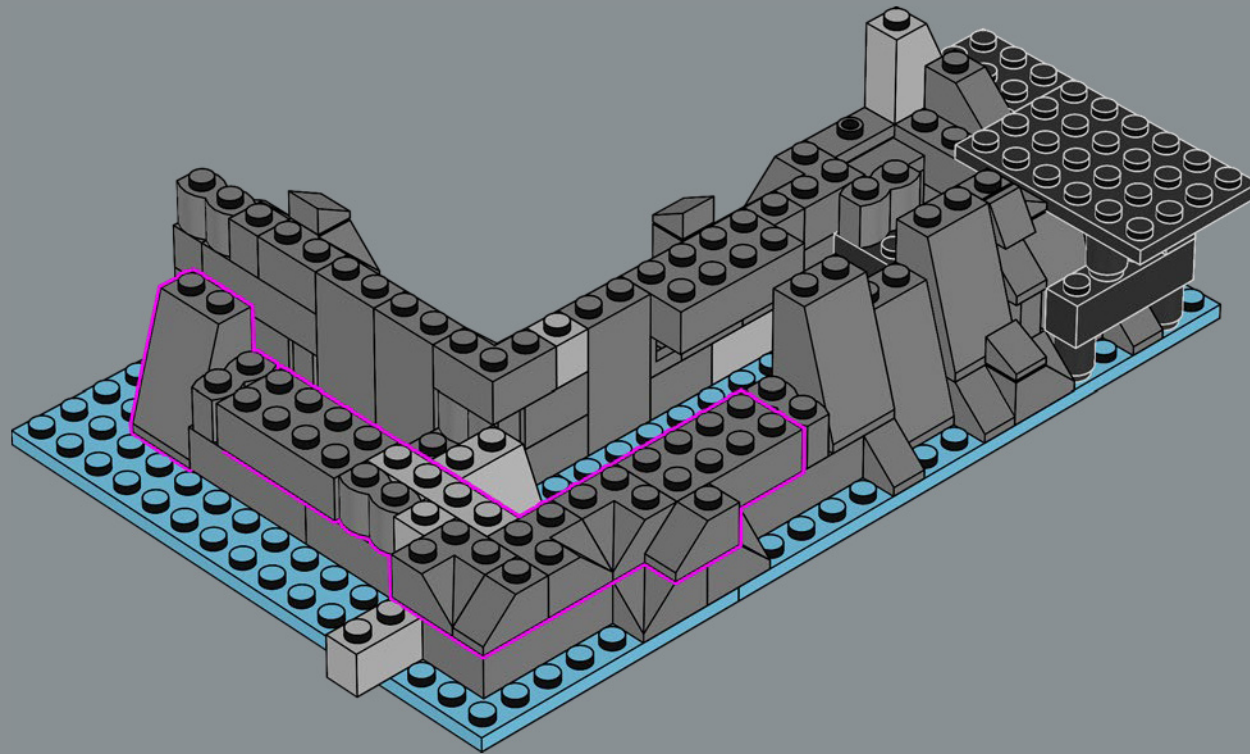

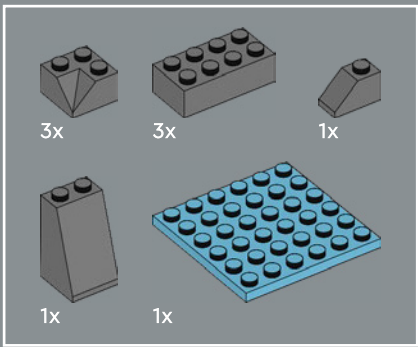

24

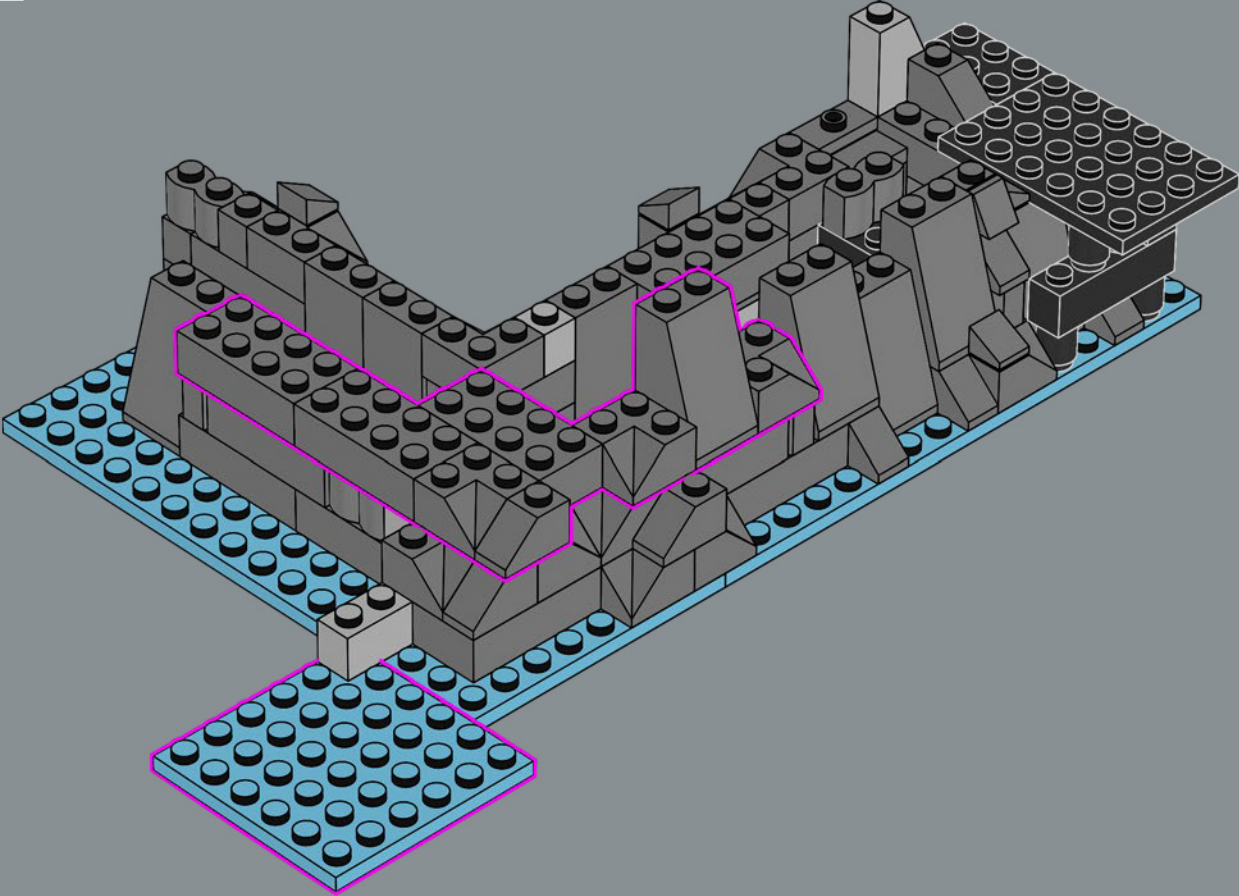

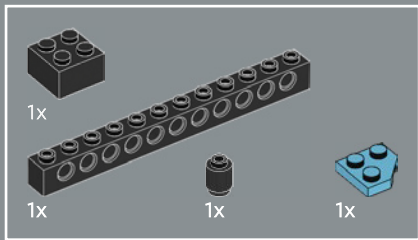

25

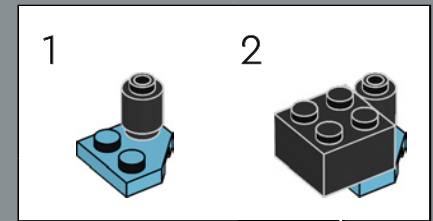
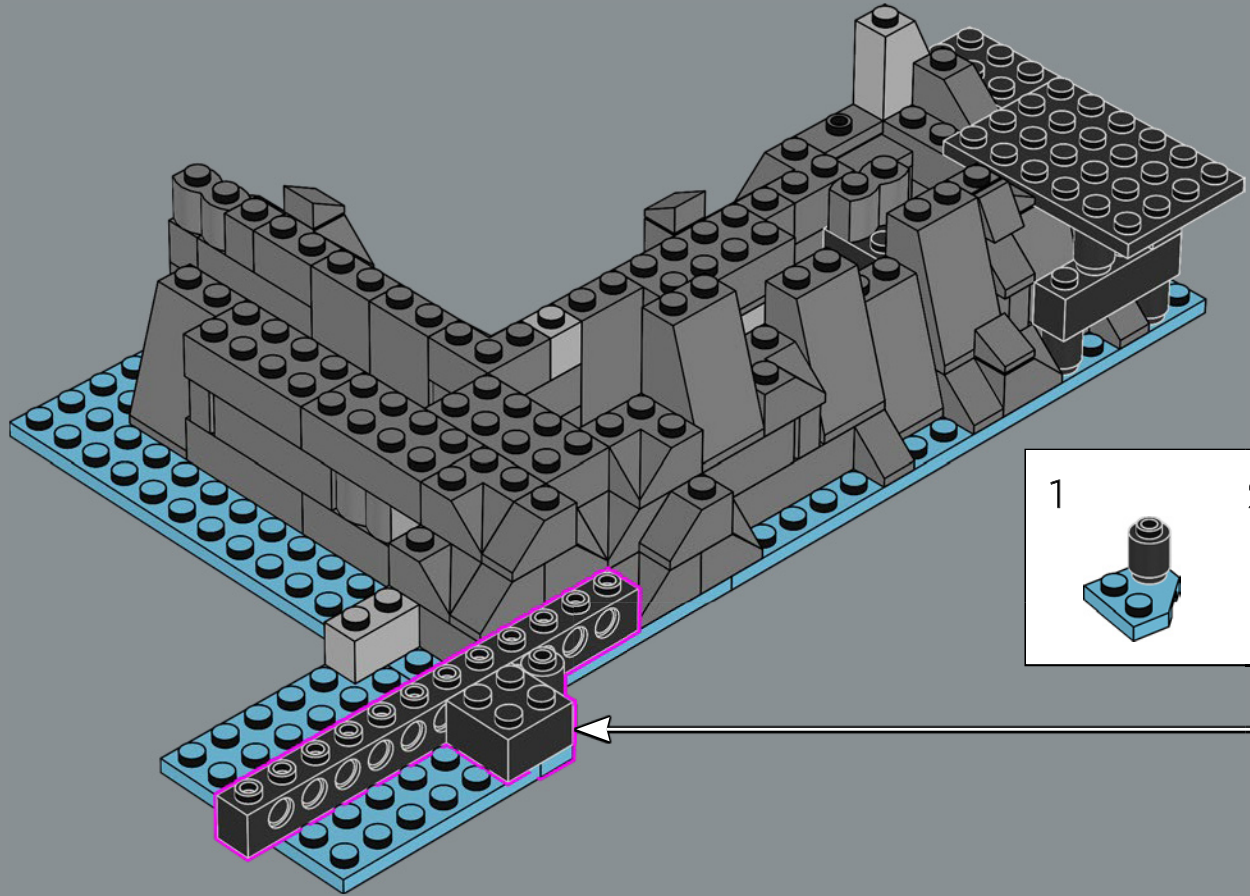

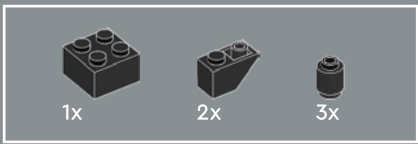

26

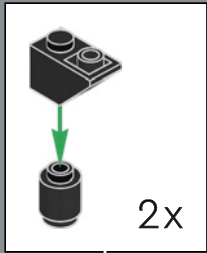
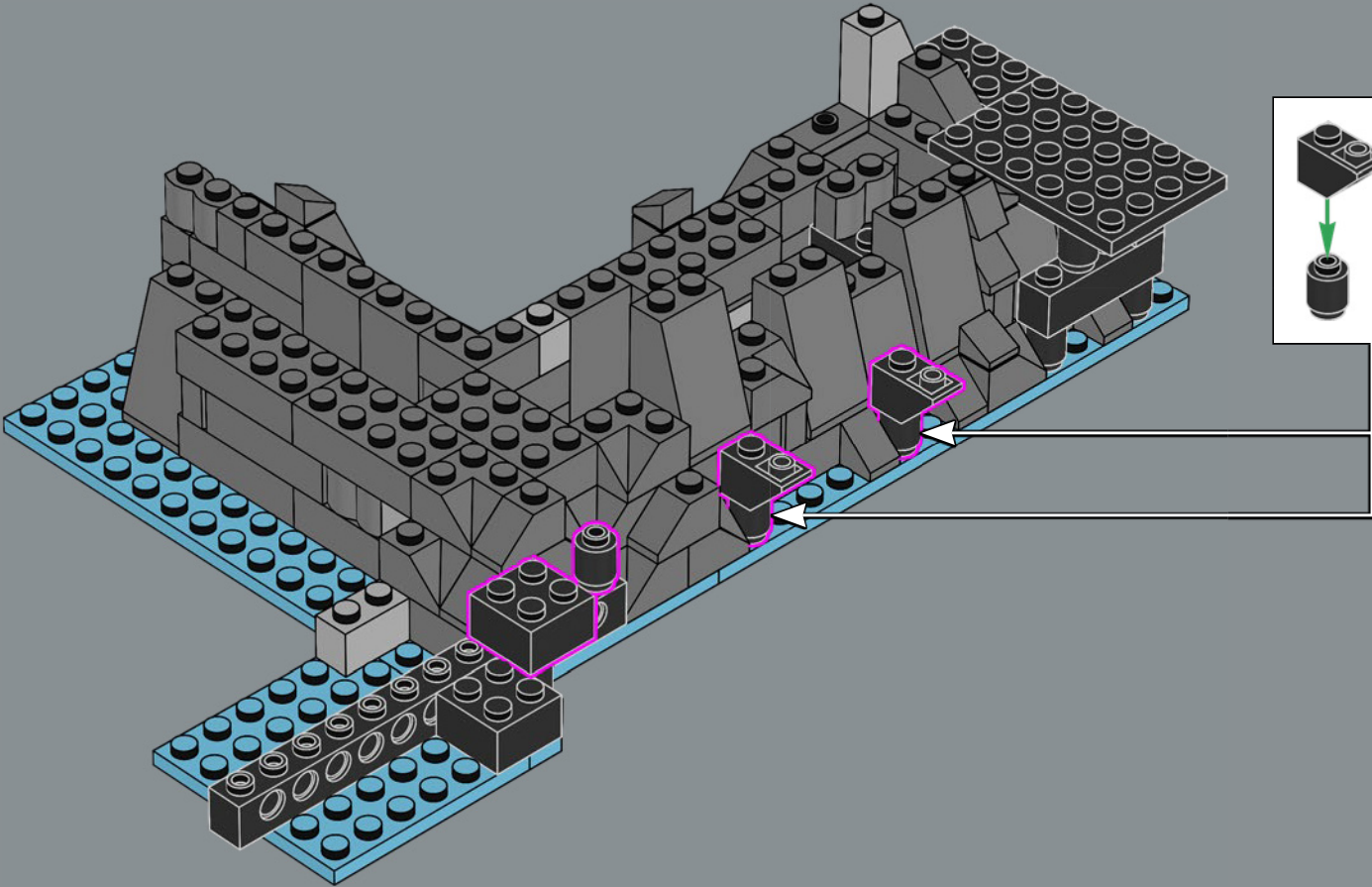

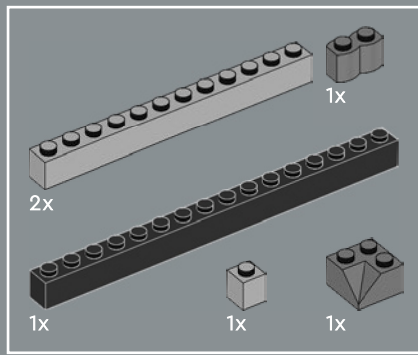

27

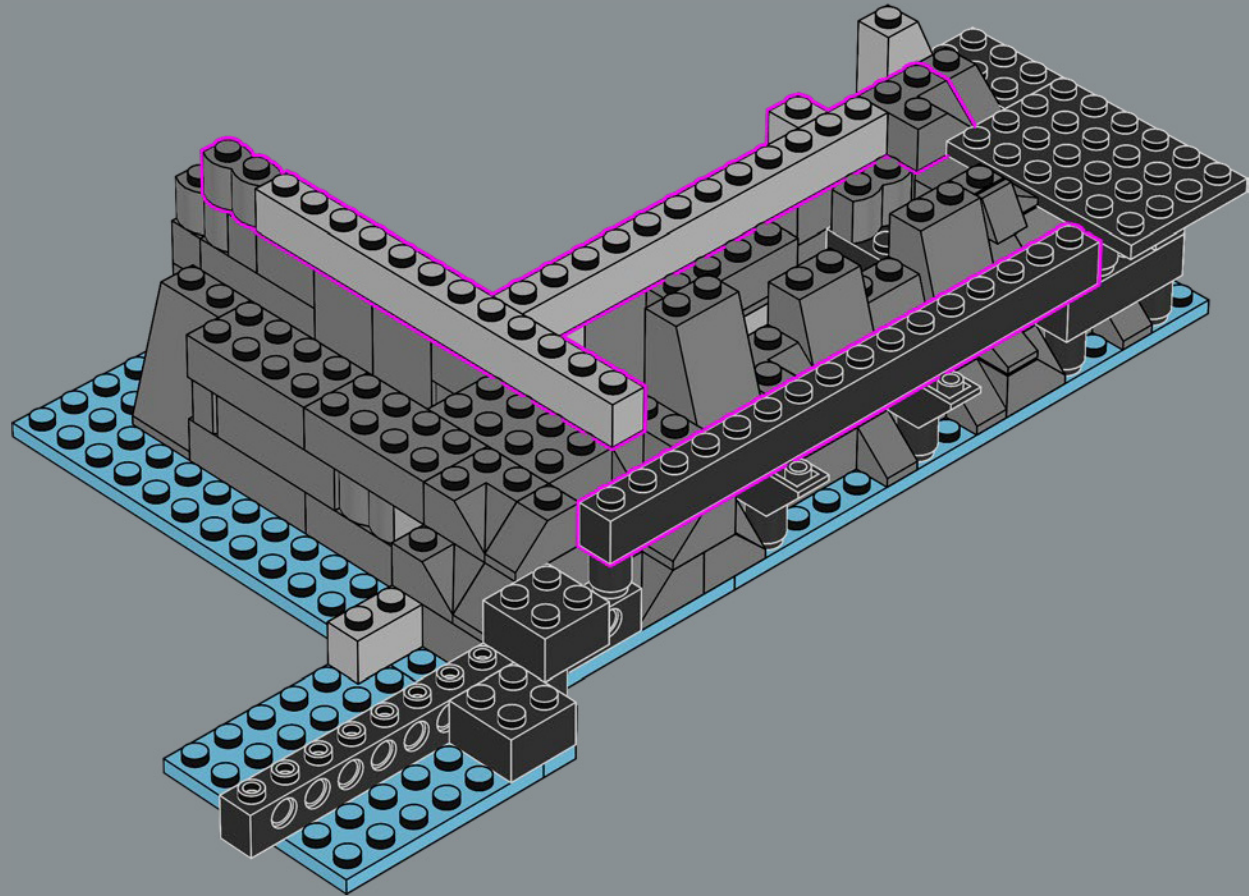

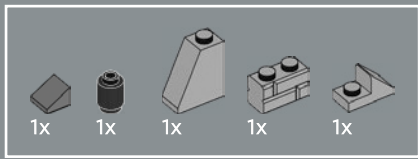

29

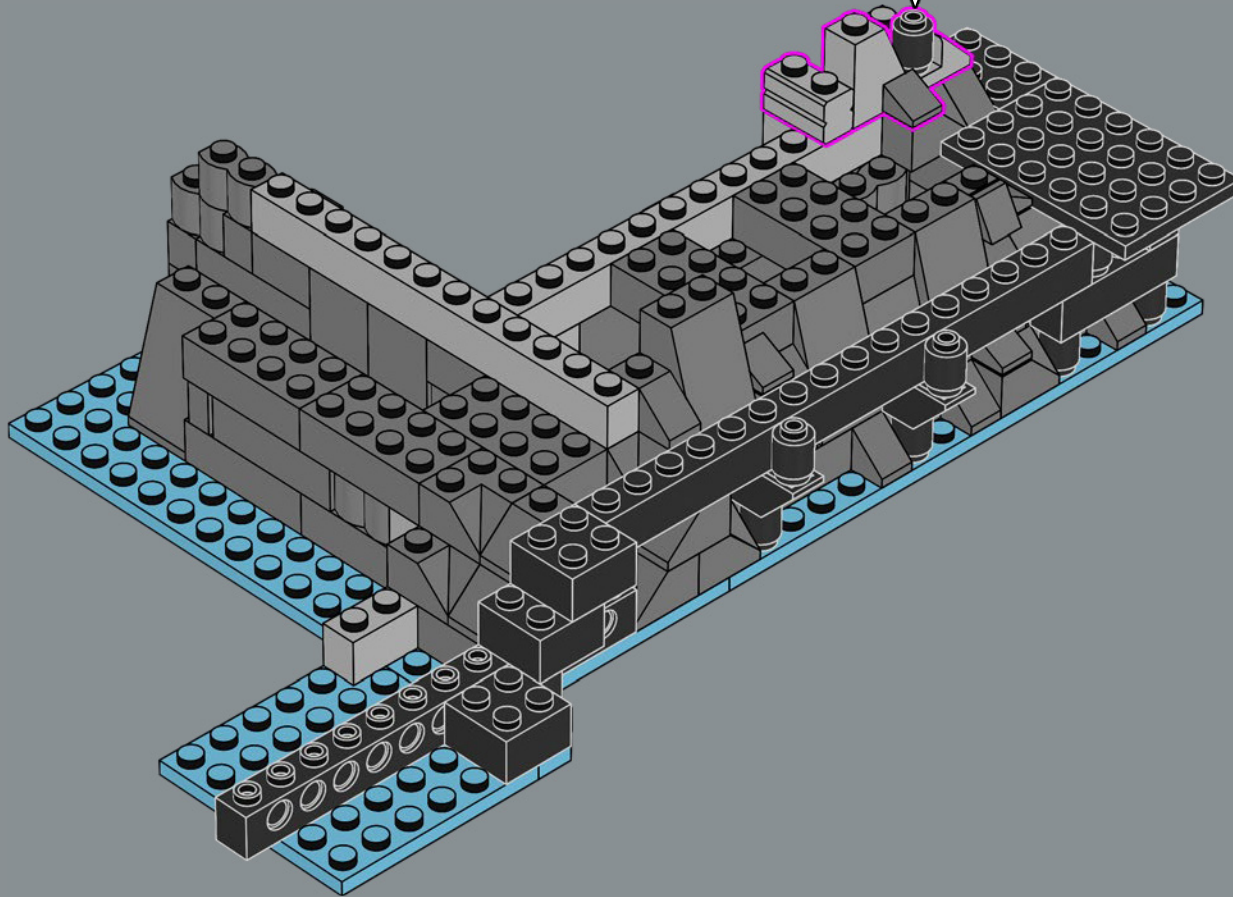
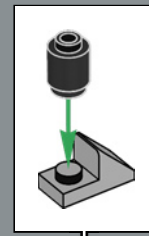

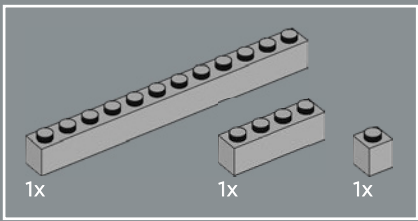

30

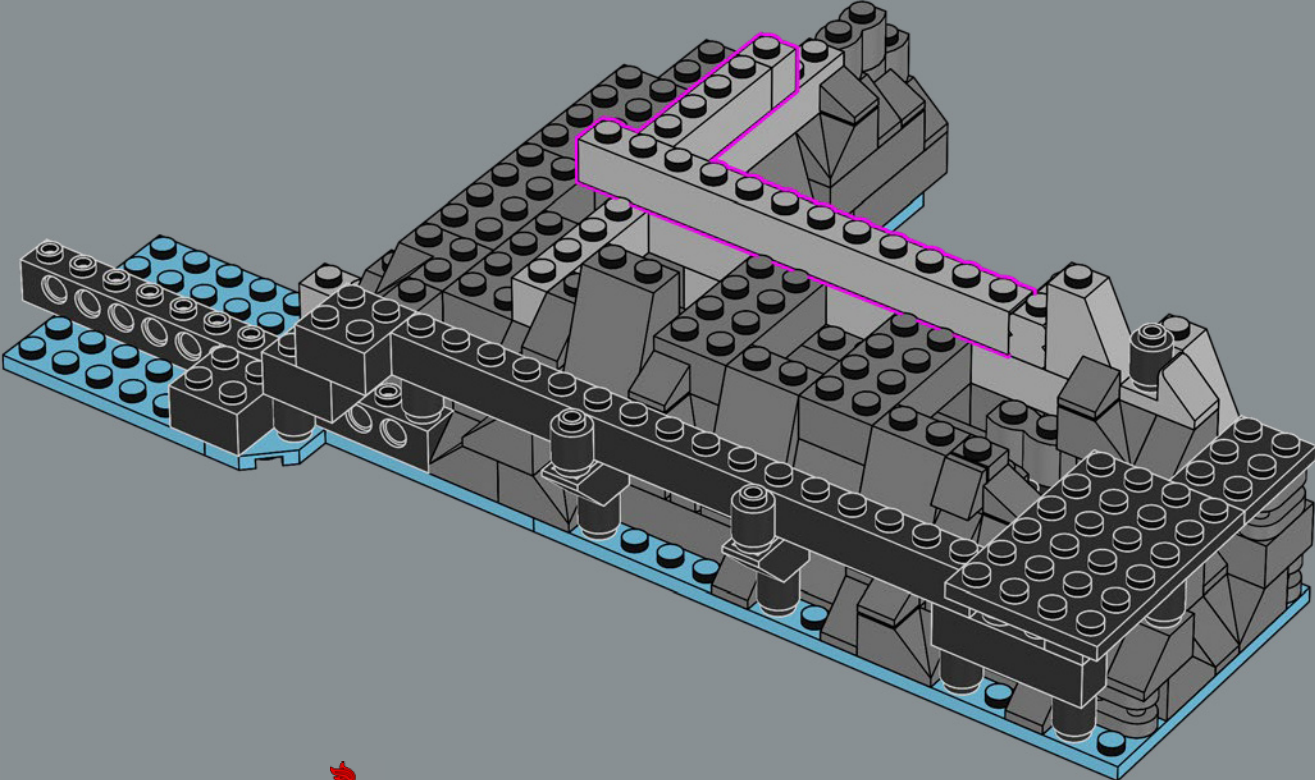

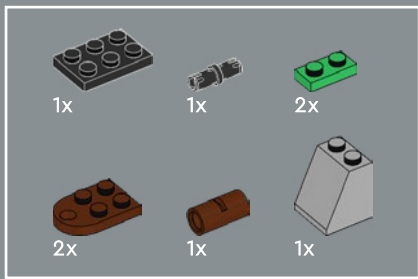

31

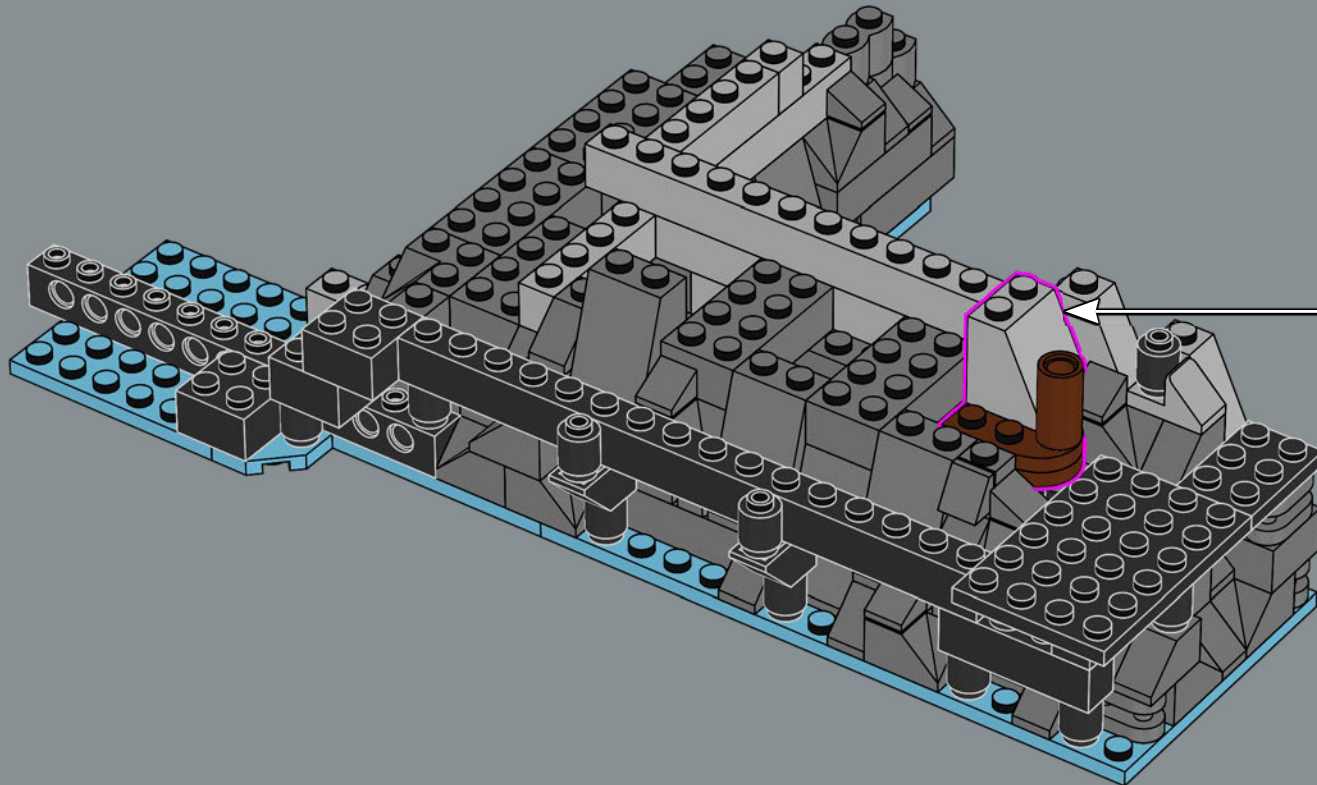
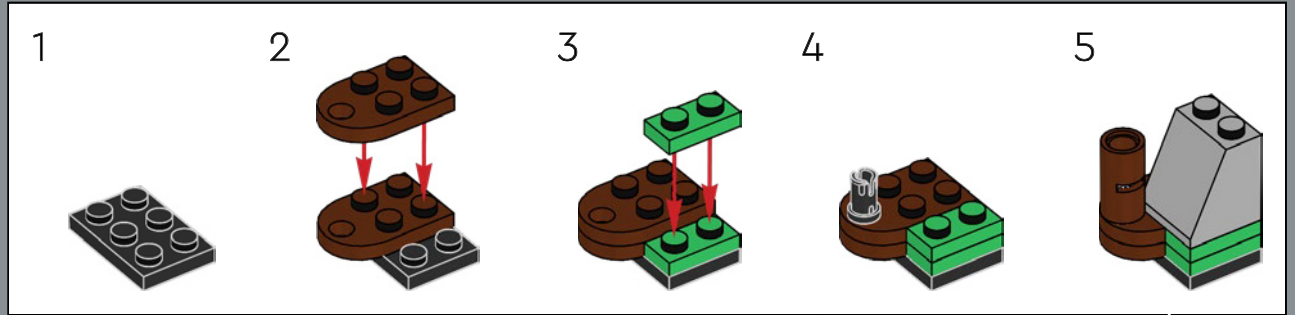

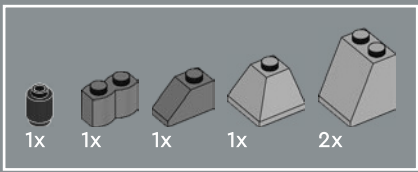

32

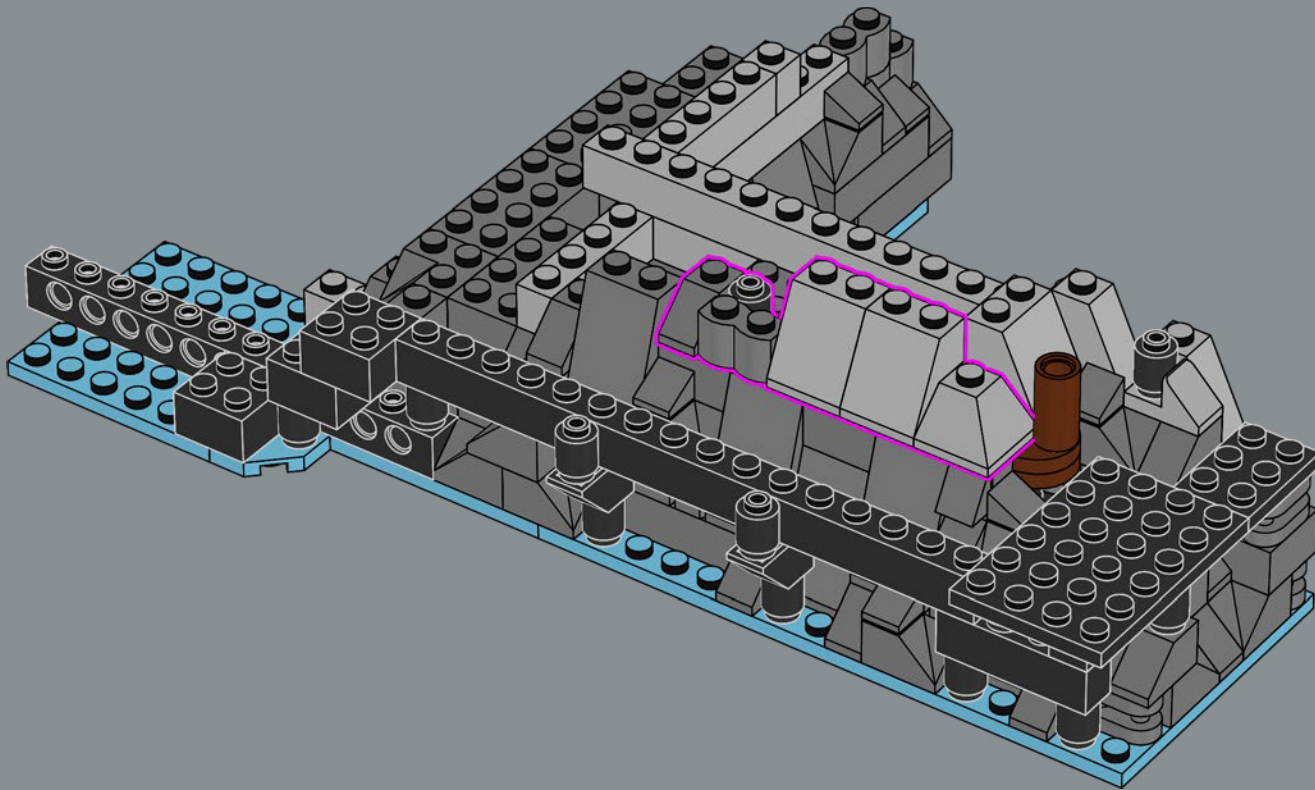

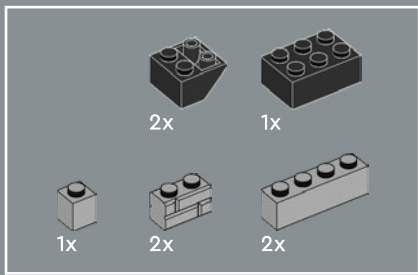

33

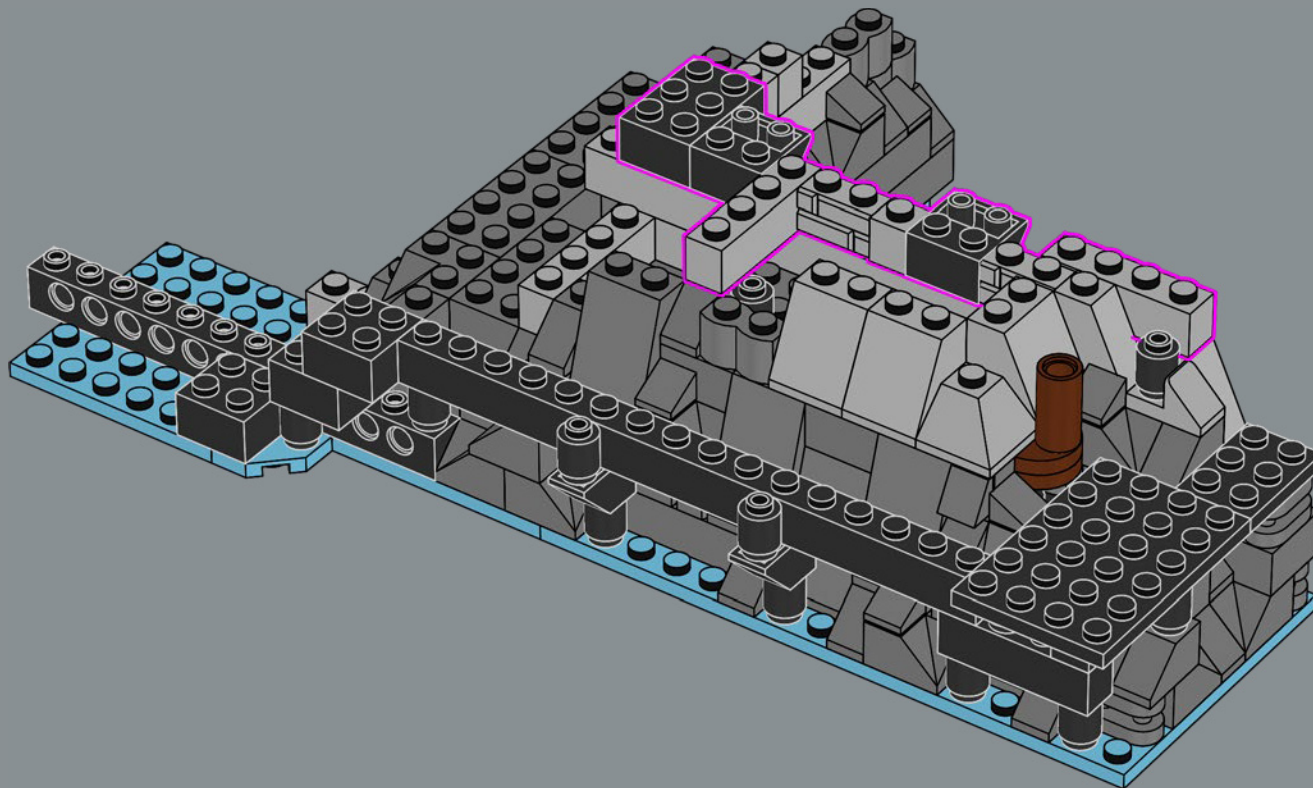

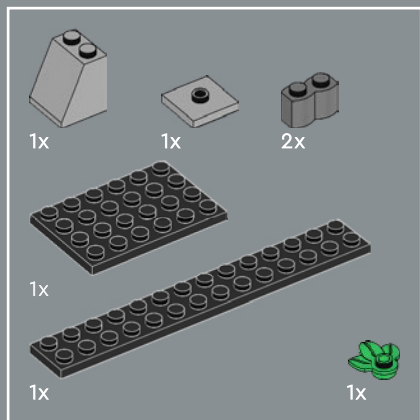

34

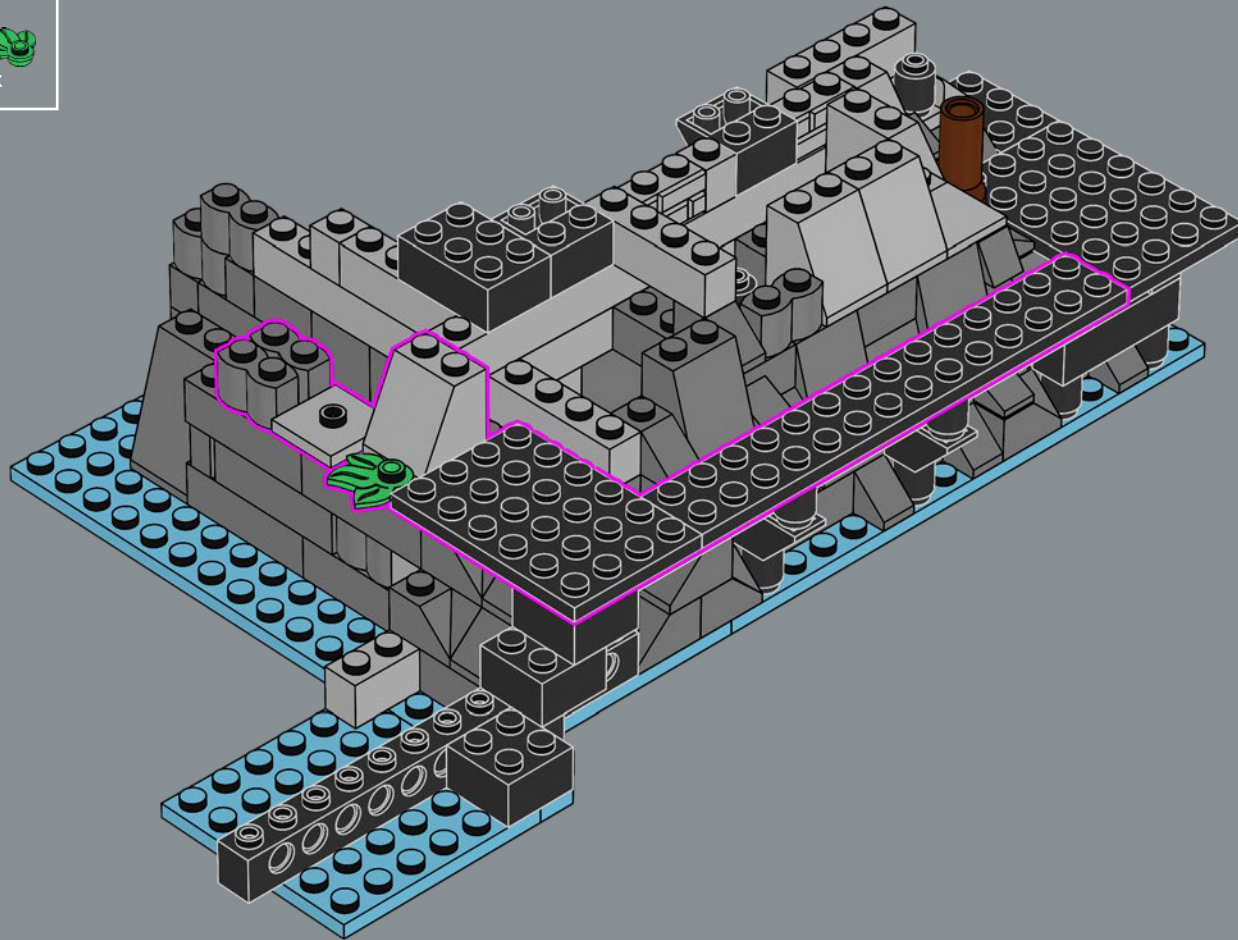

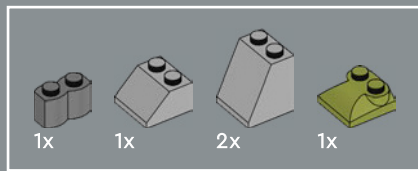

35

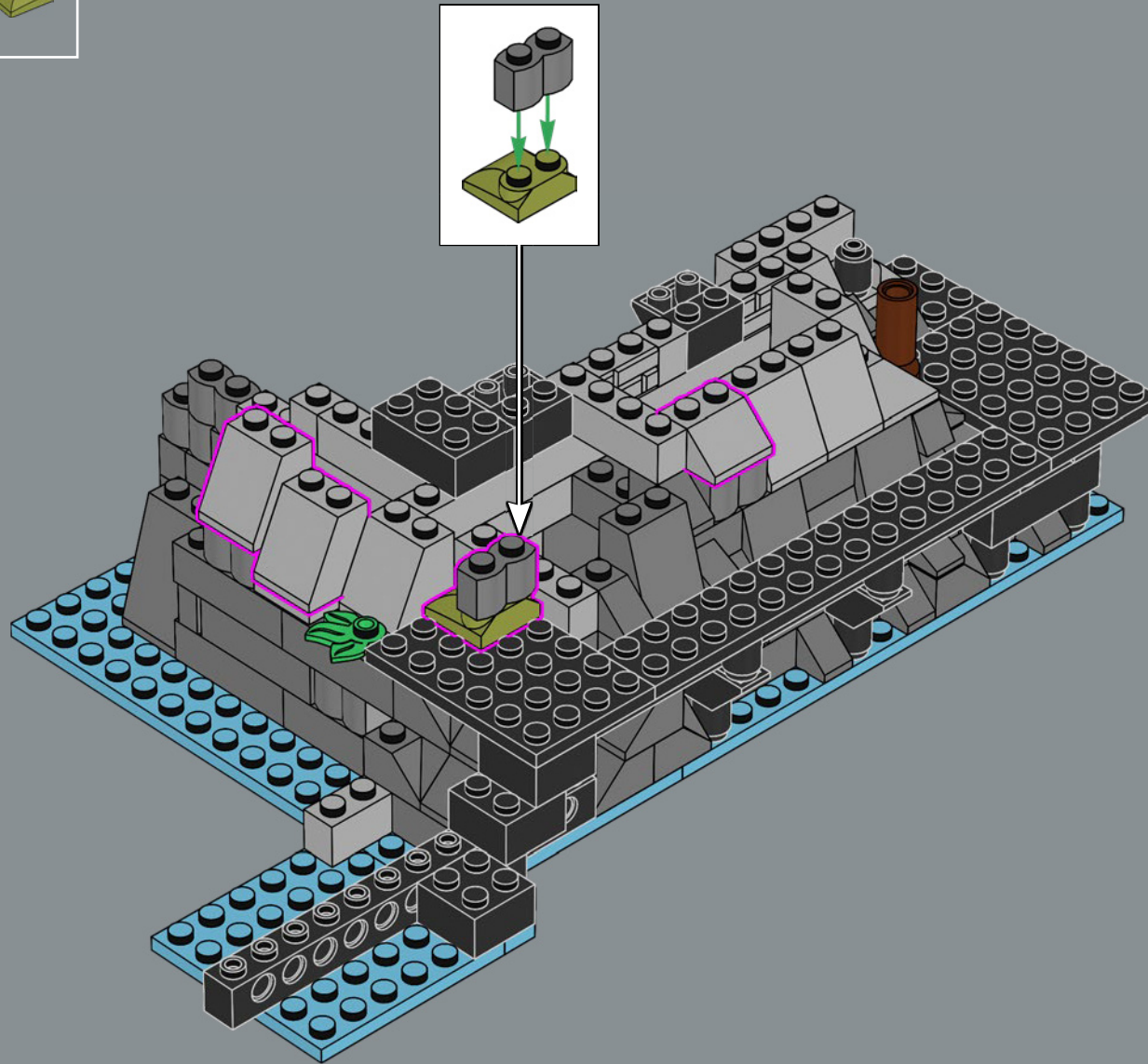

- 4x 
- 1x 
- 1x 

36

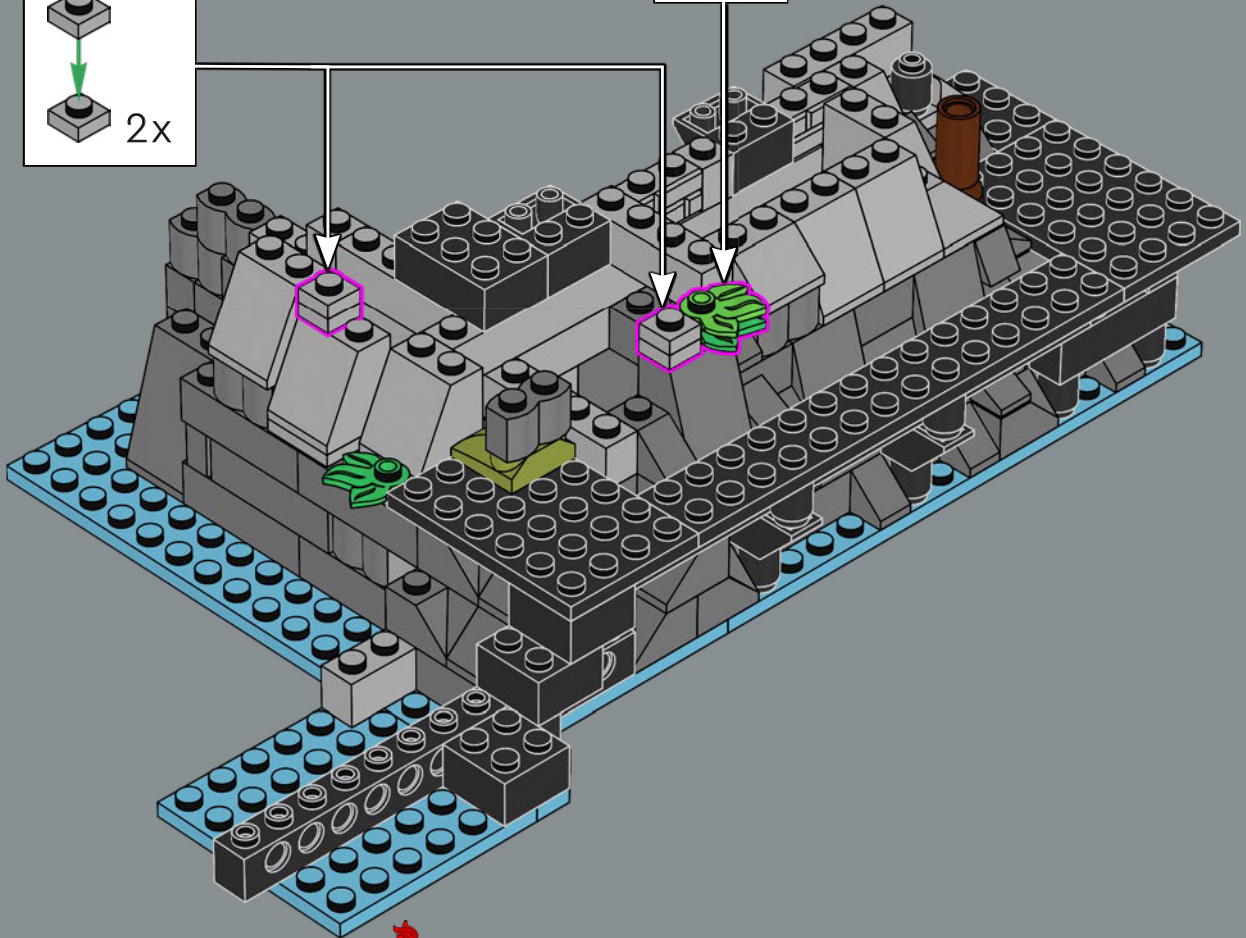
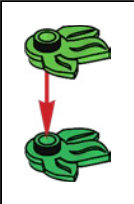
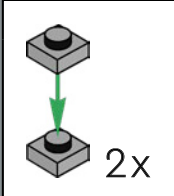

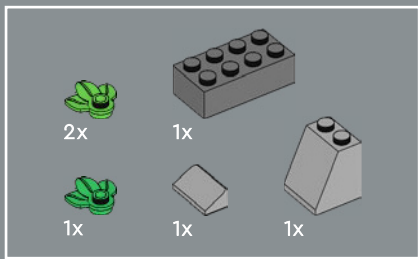

37

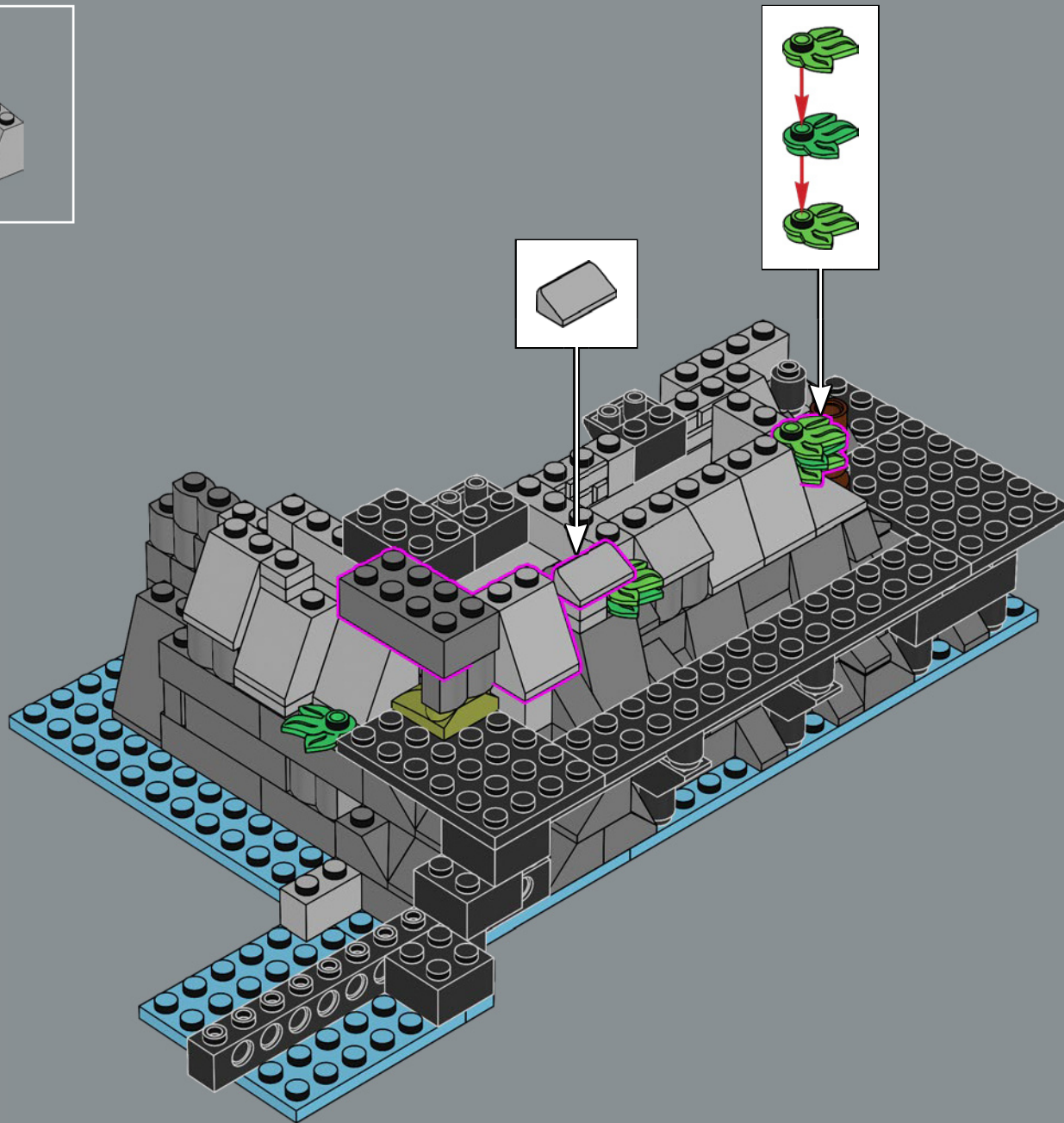

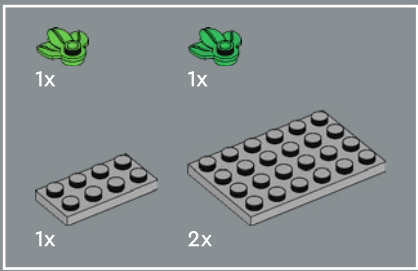

38

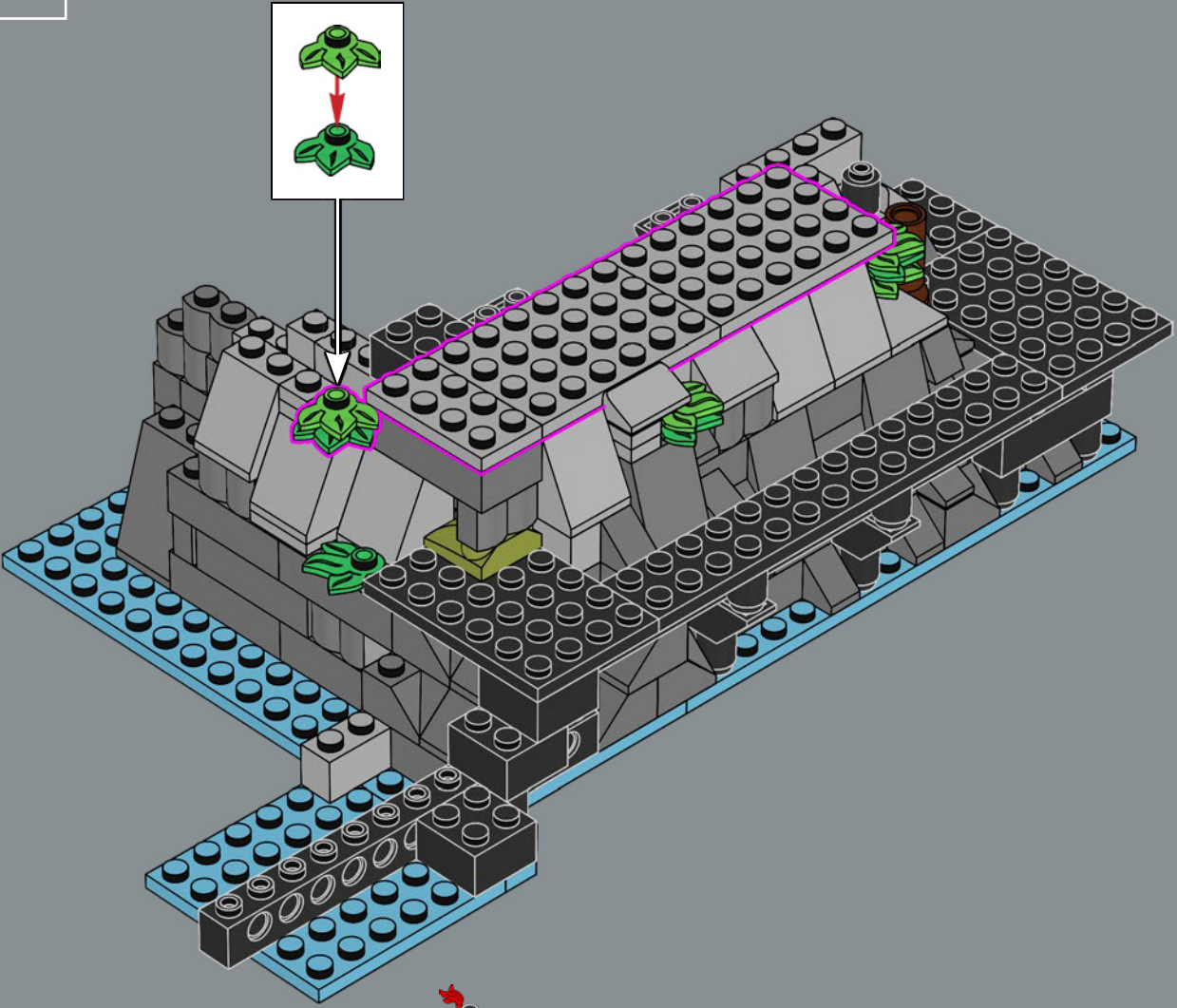

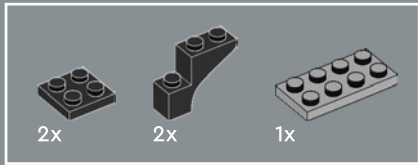

39

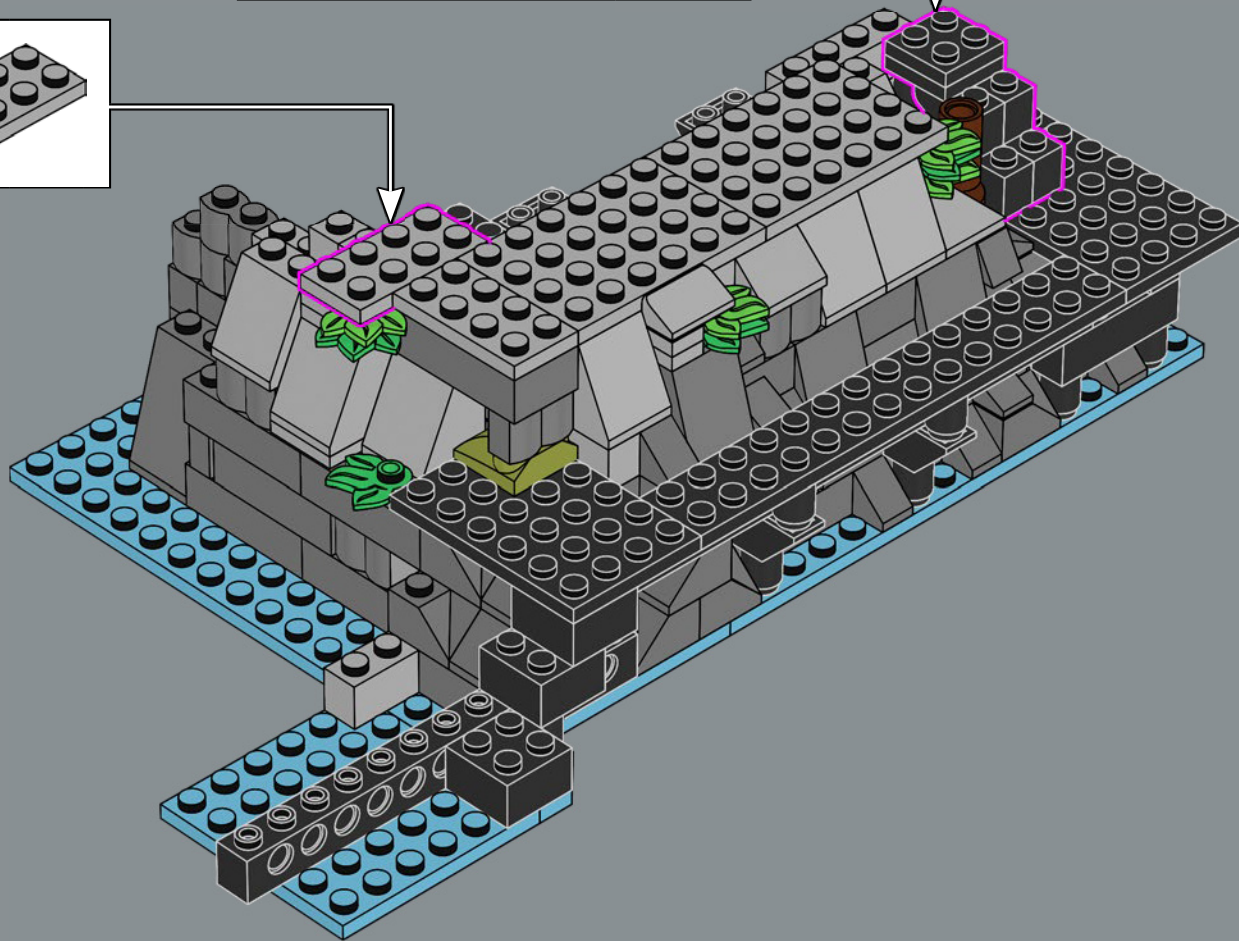
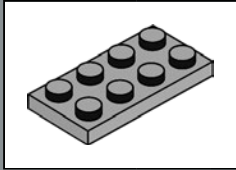
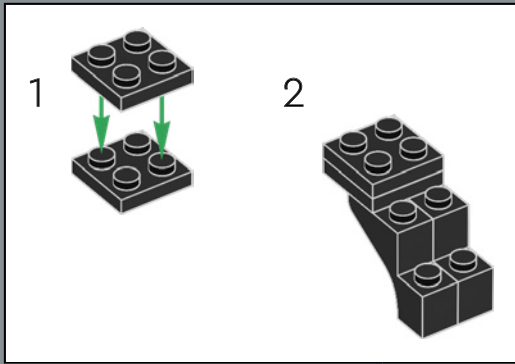

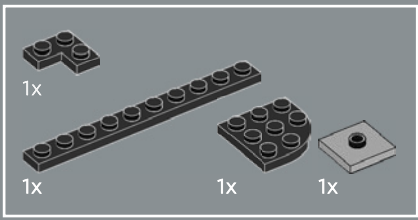

40

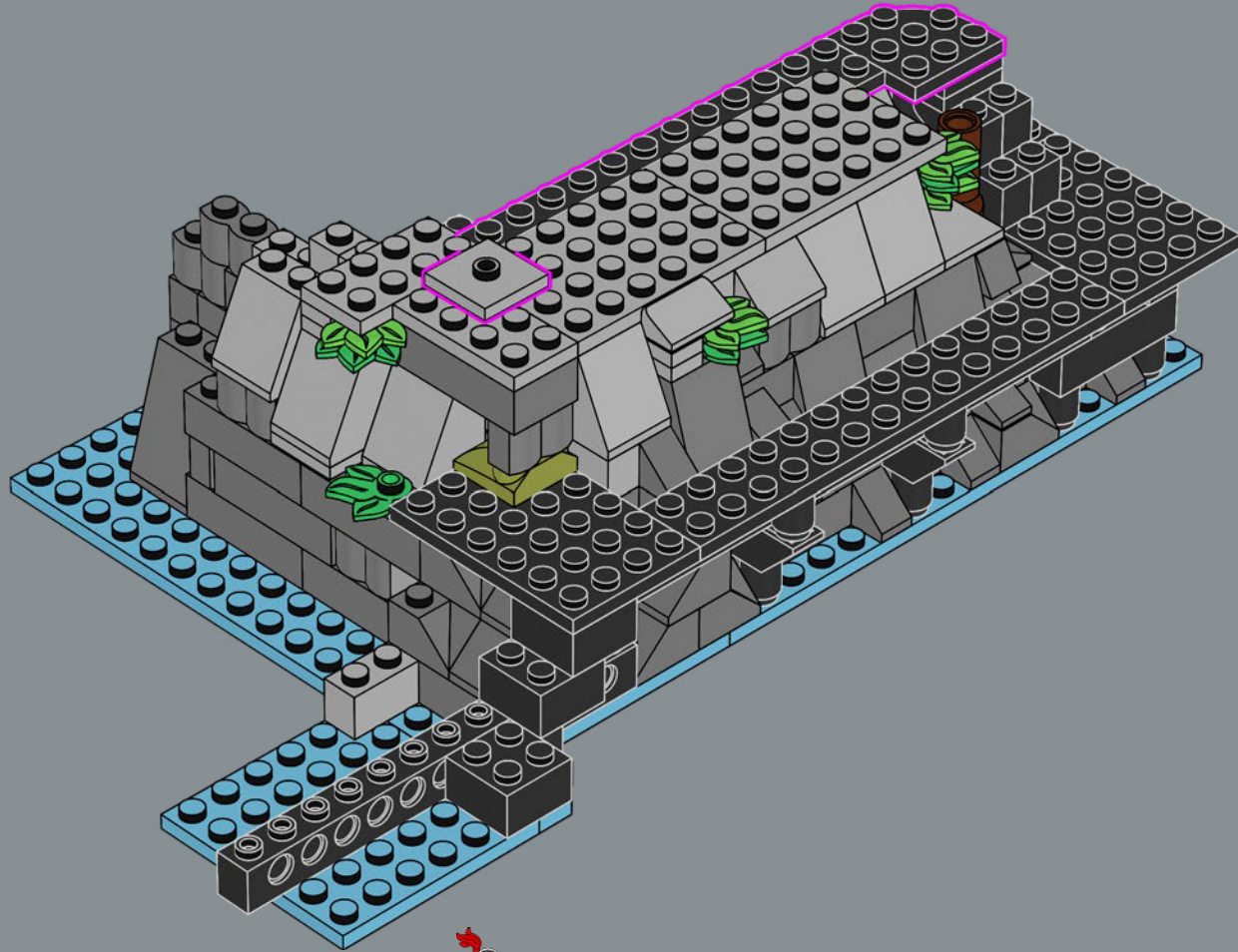

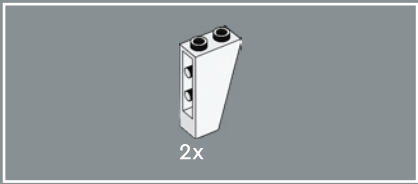

41

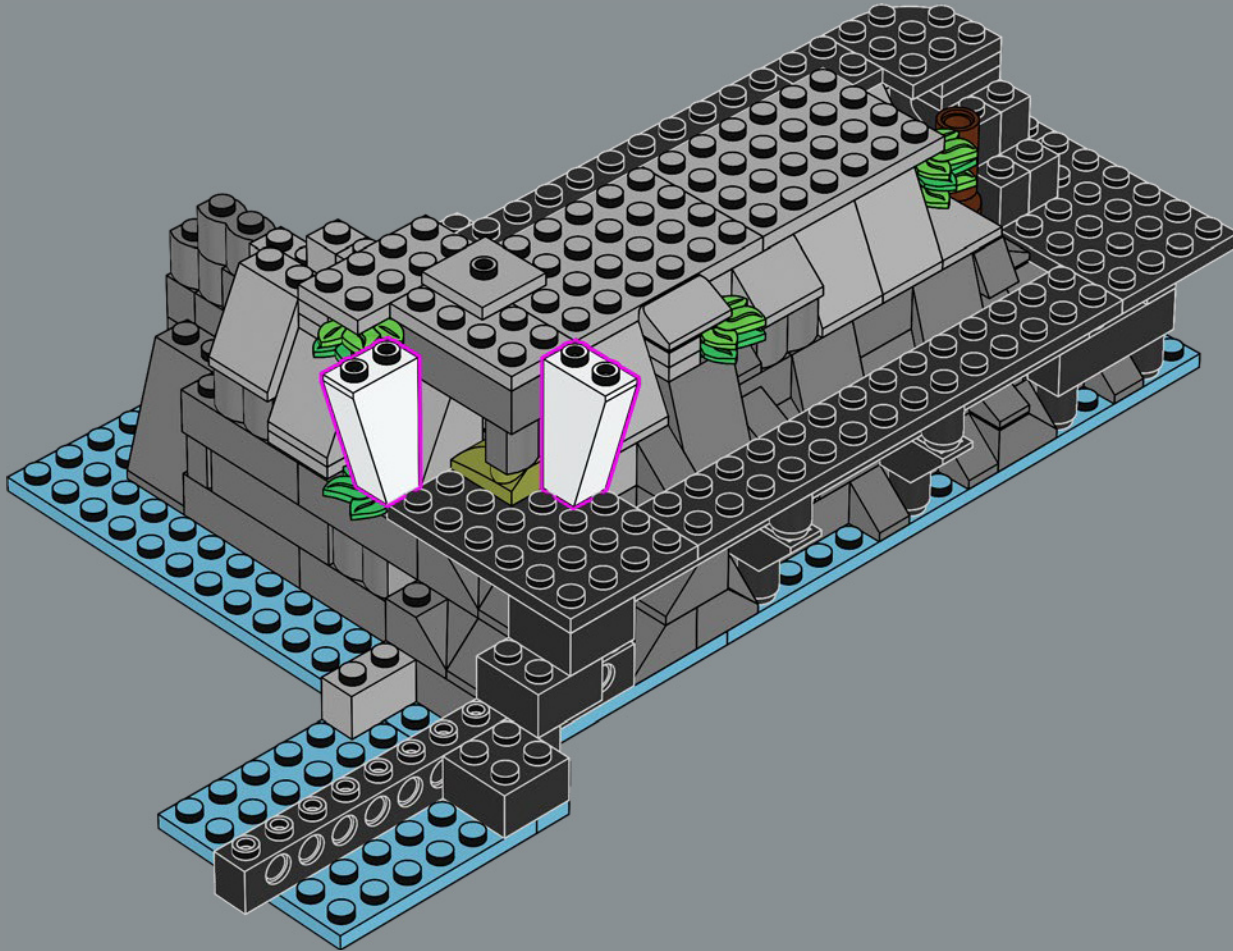

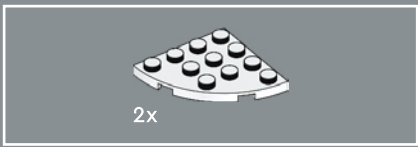

42

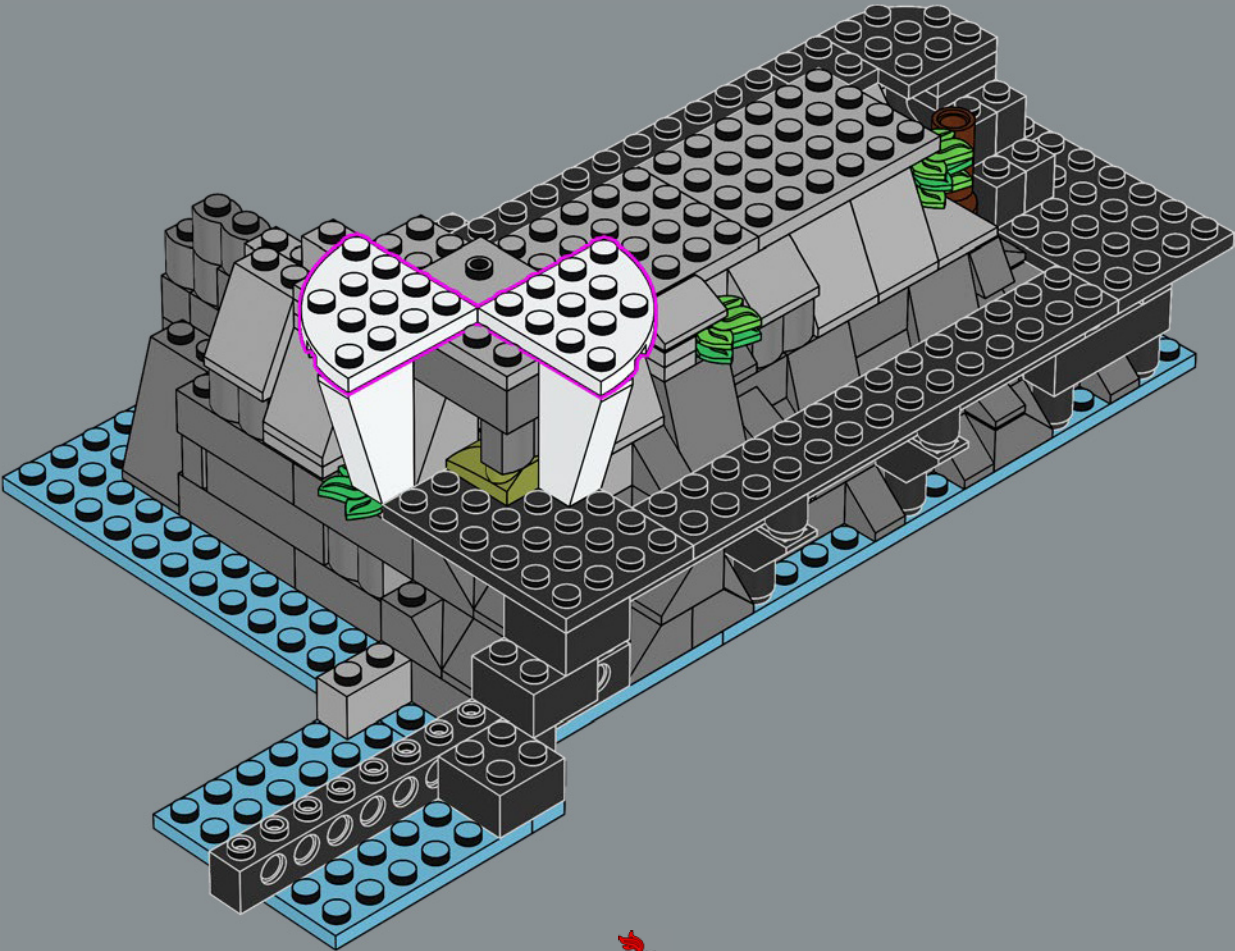

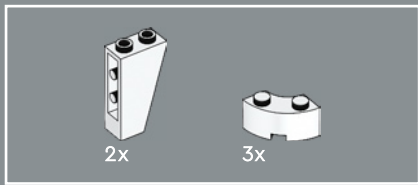

43

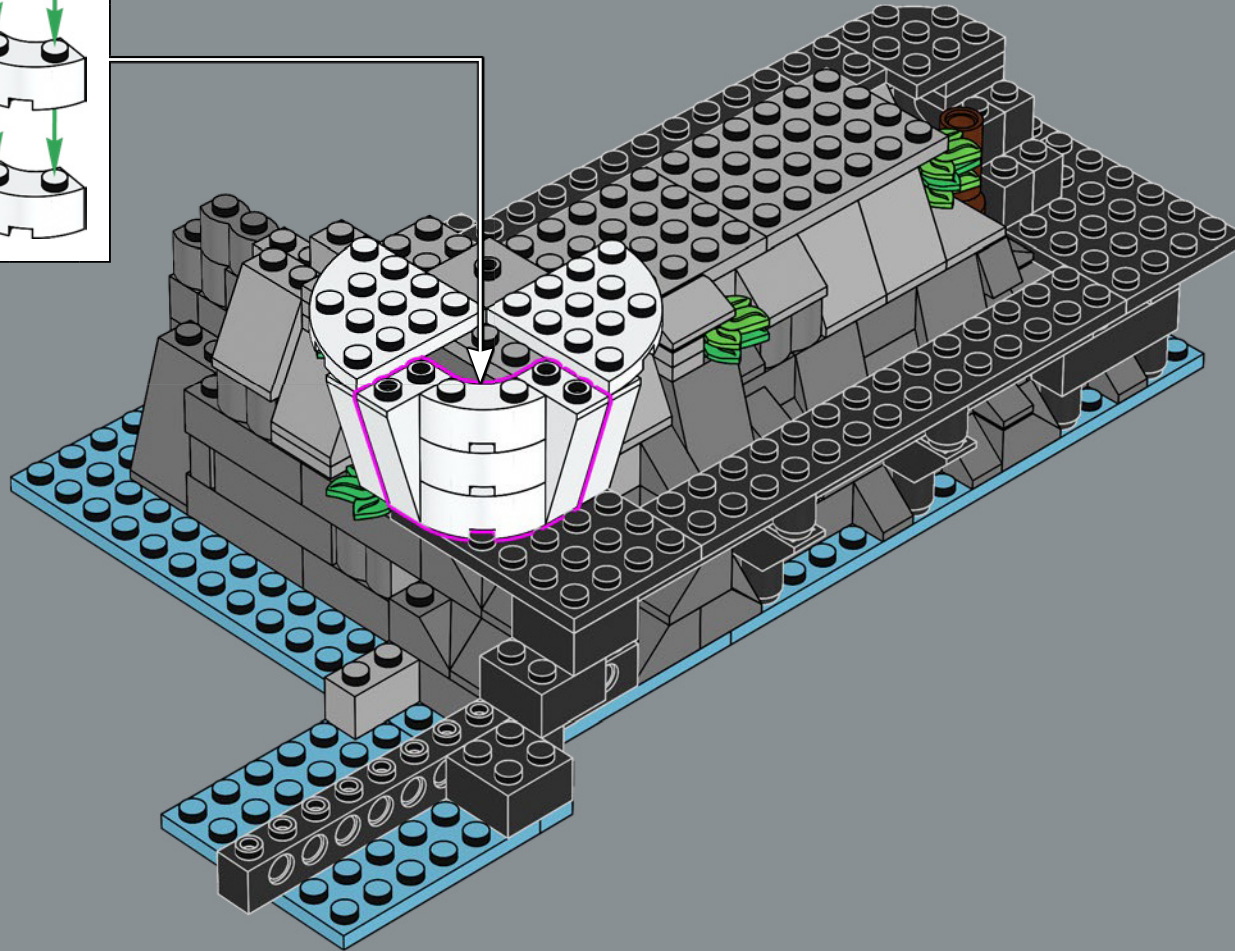
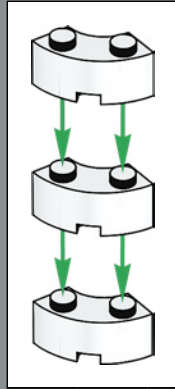



44

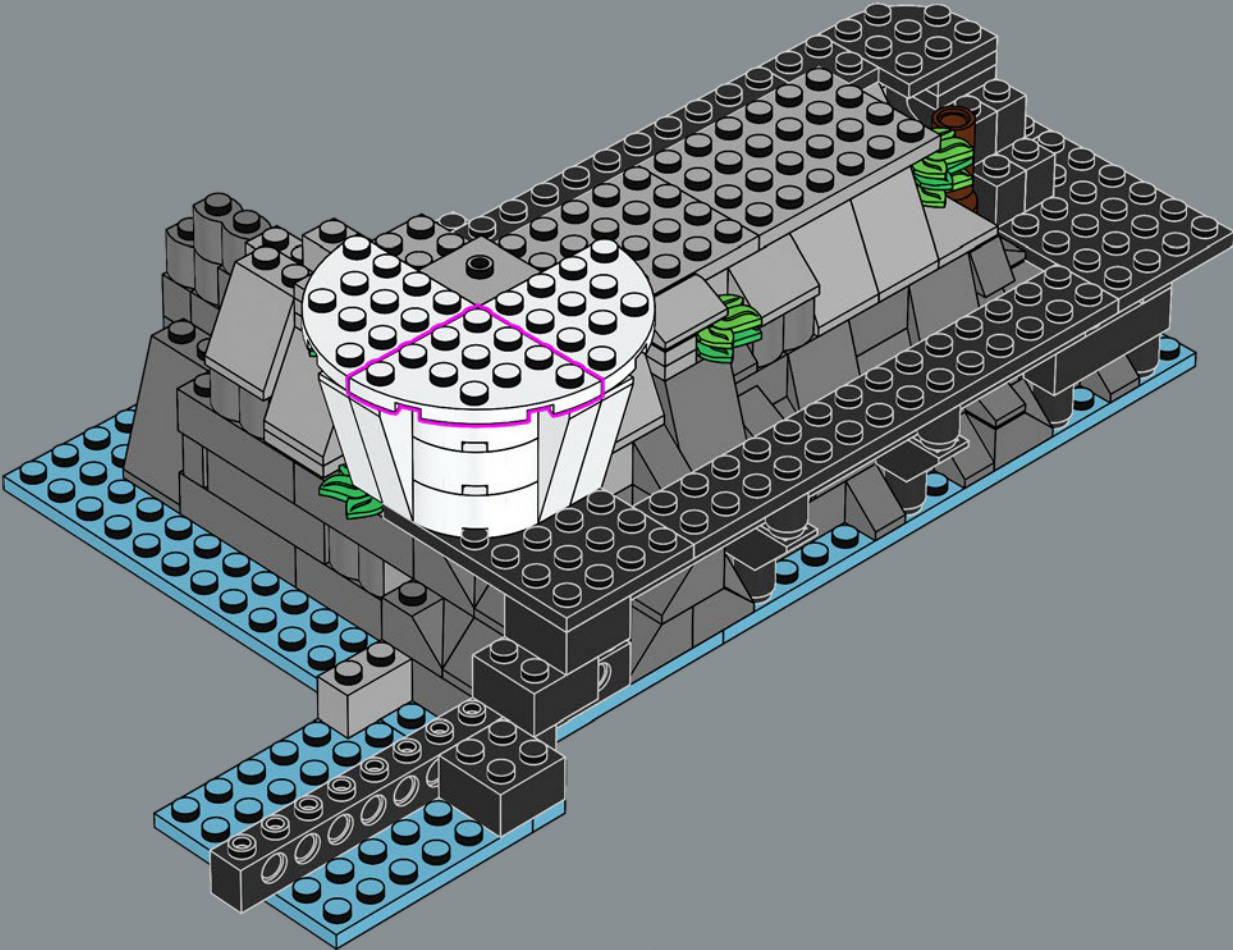

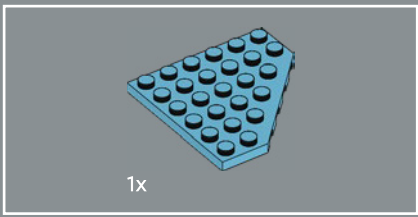

46

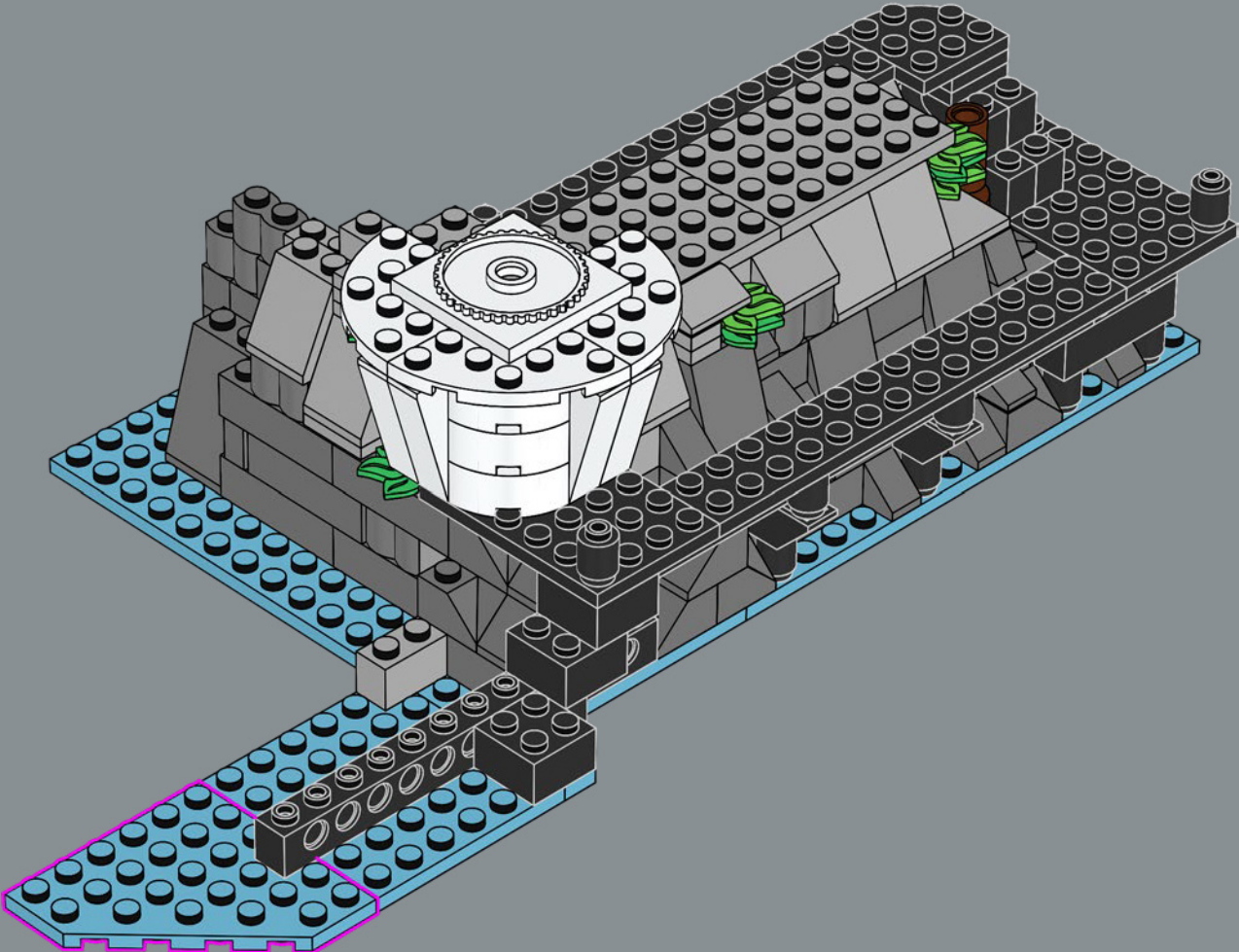

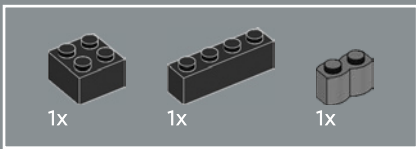

47

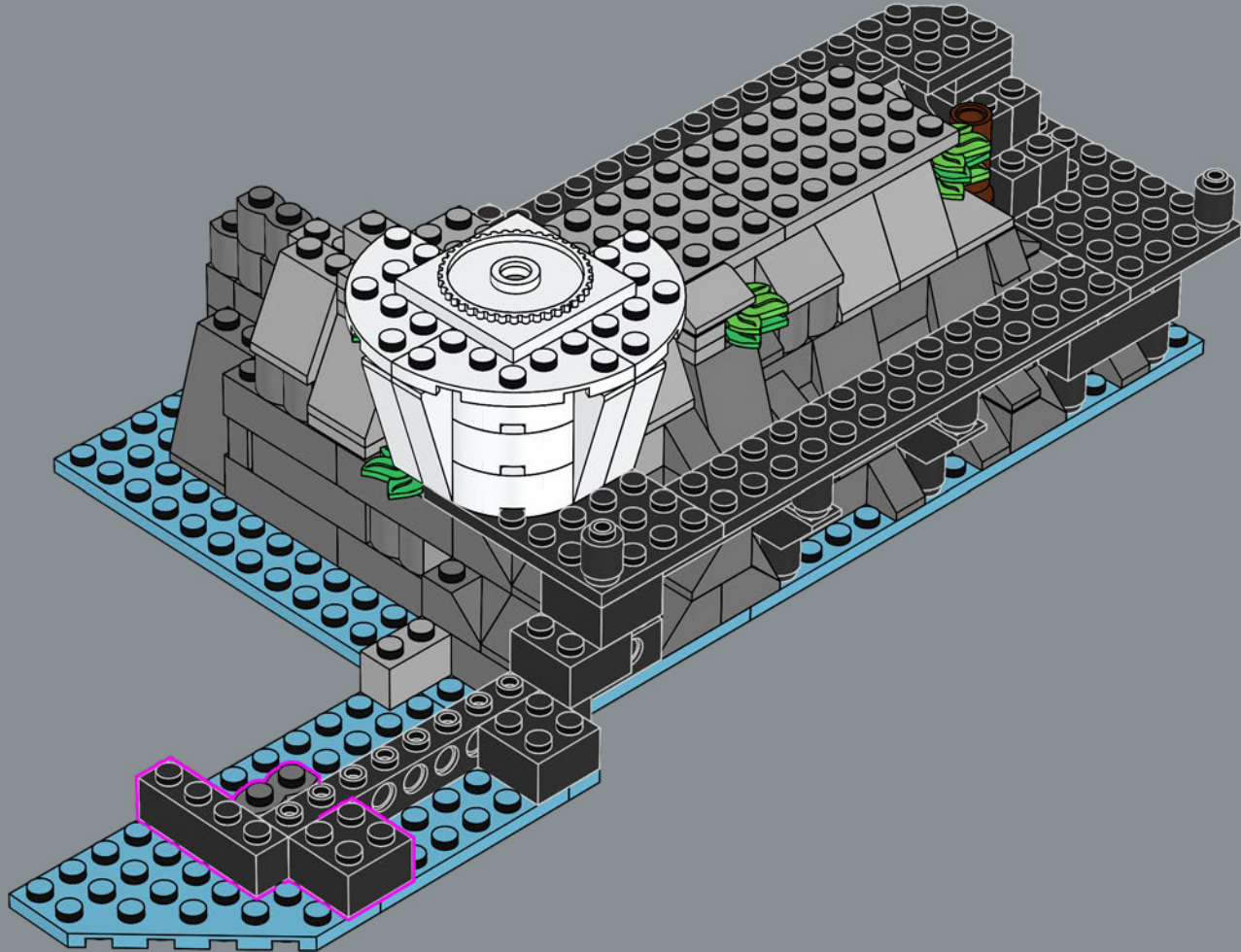

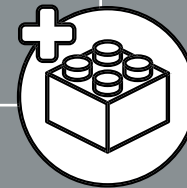
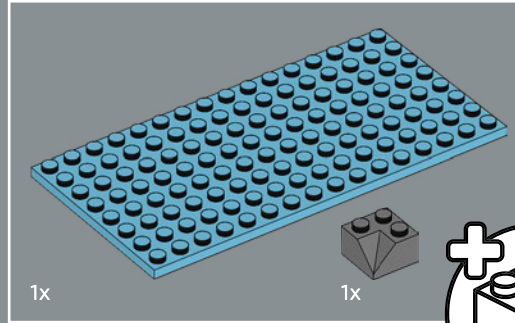
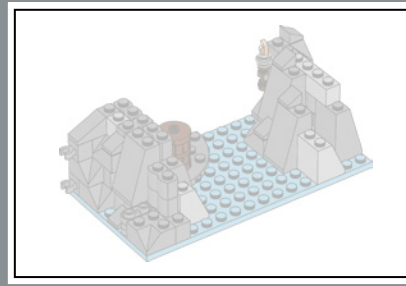
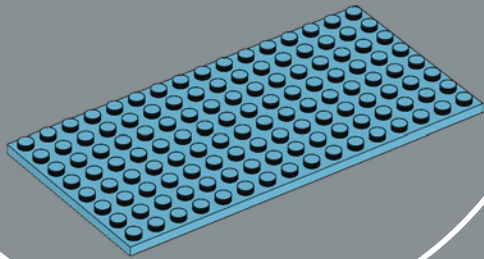
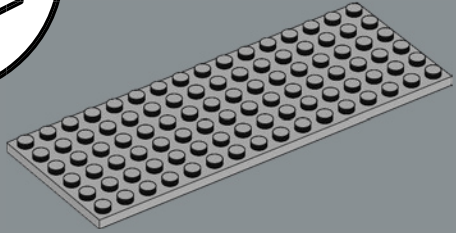
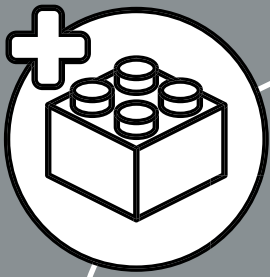

48

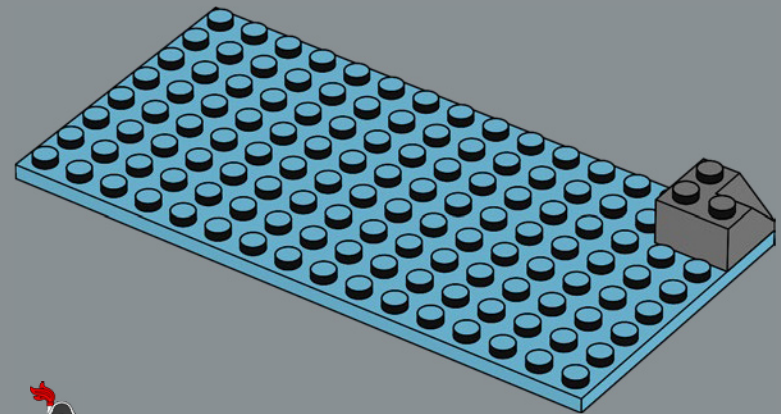



49

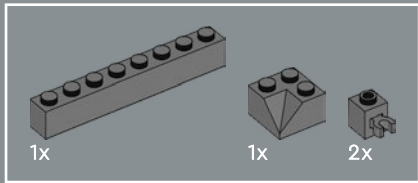
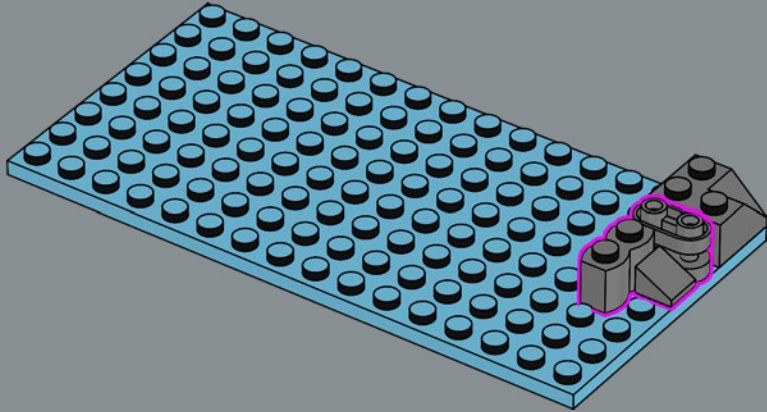

50

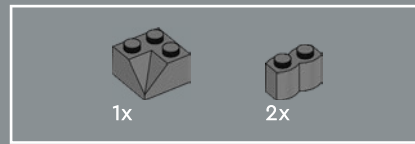
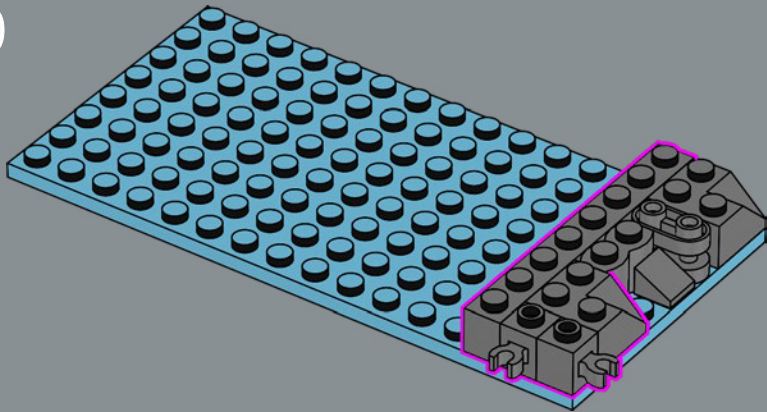

51

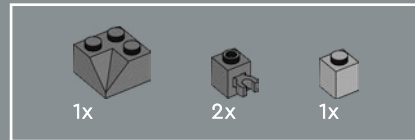
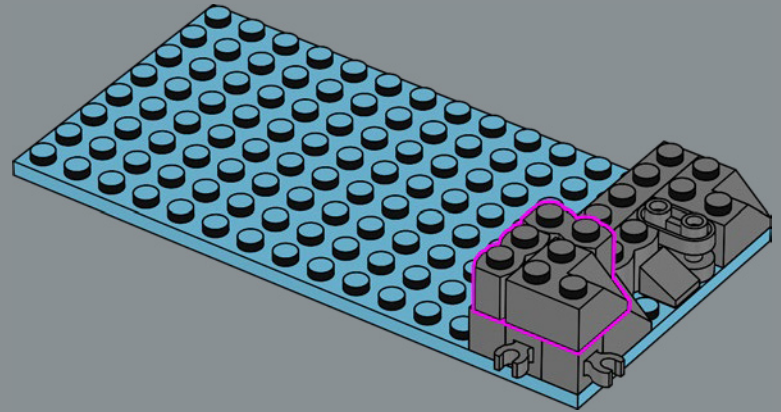

52

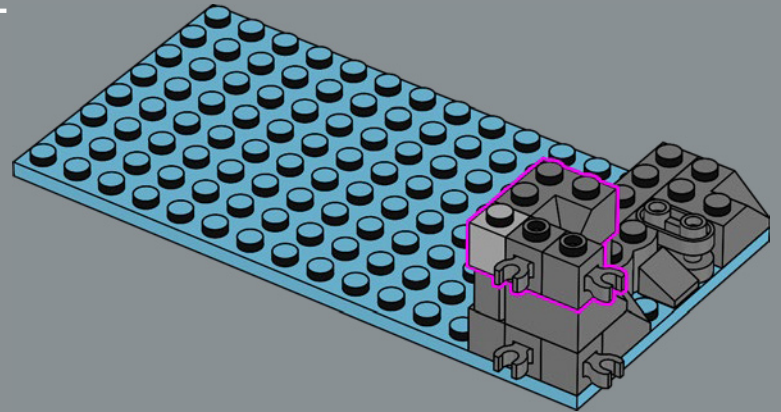

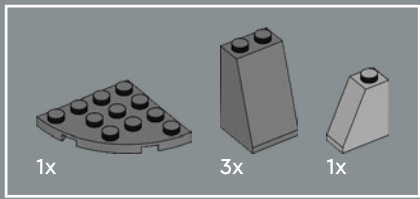

53

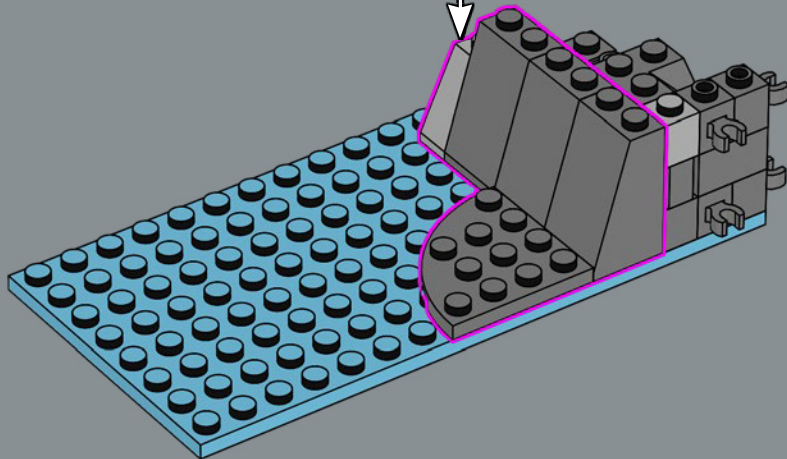
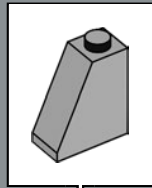

54

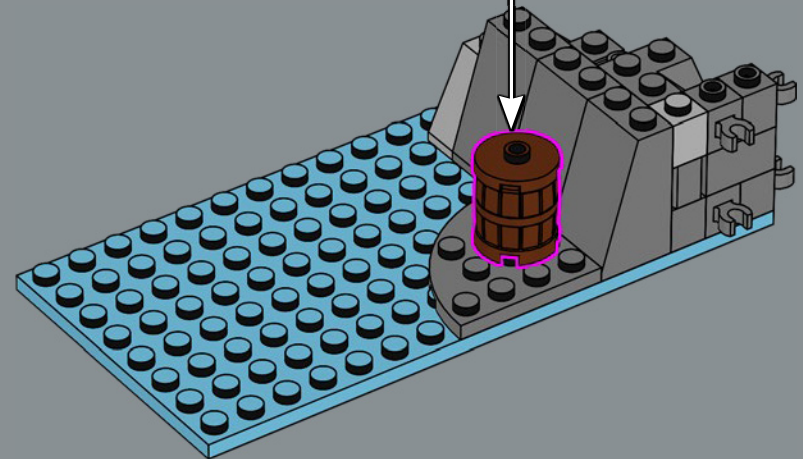
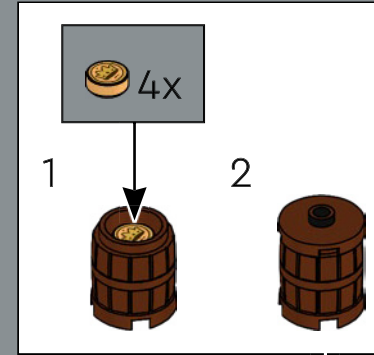

I dobloni d'oro sono conservati al sicuro,
dove nessuno può trovarli.



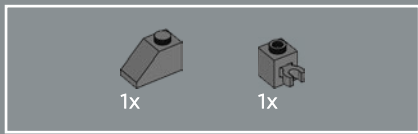

55

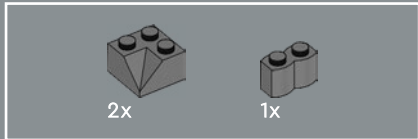
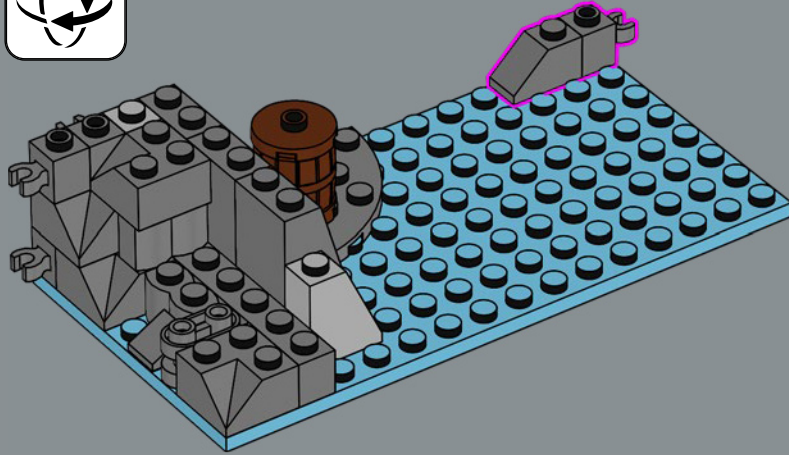

56

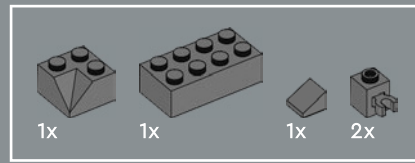
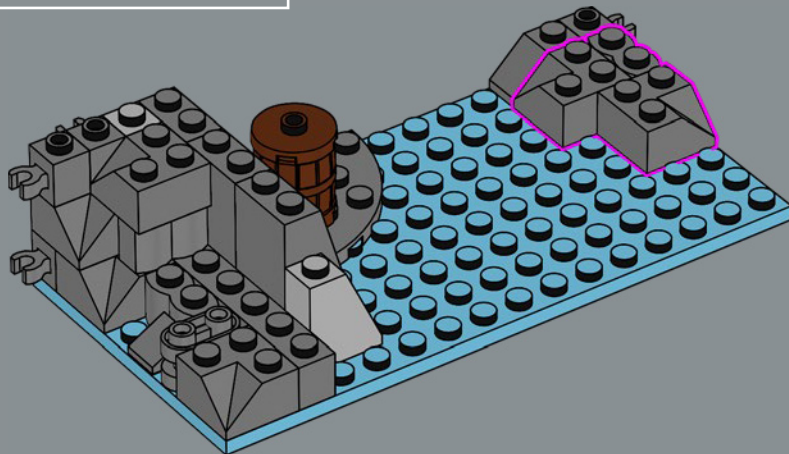

57

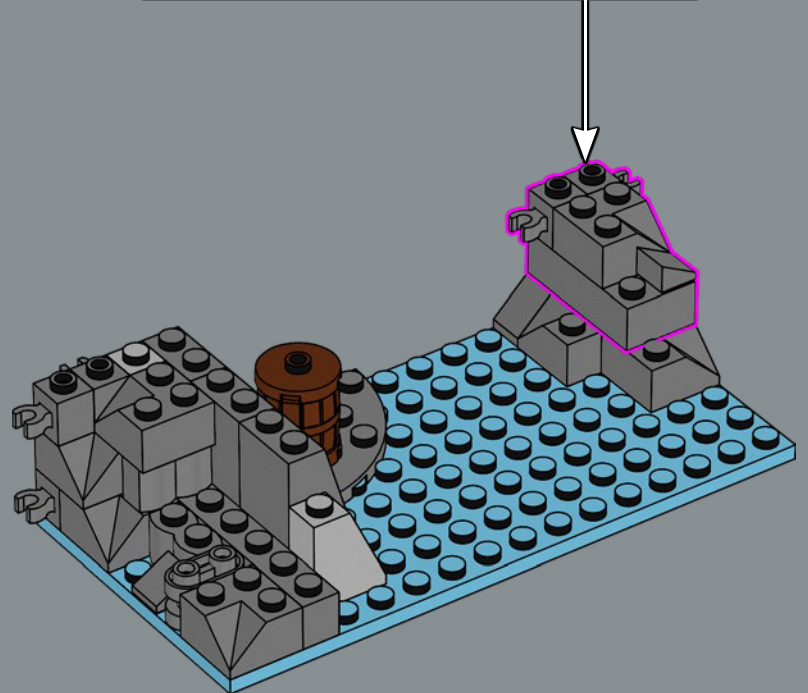
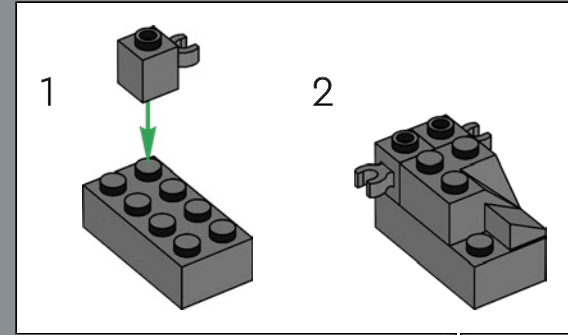

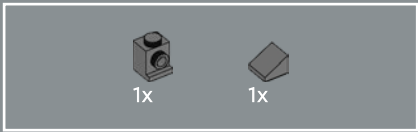

58

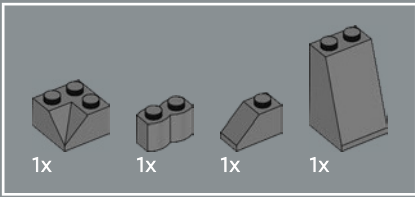
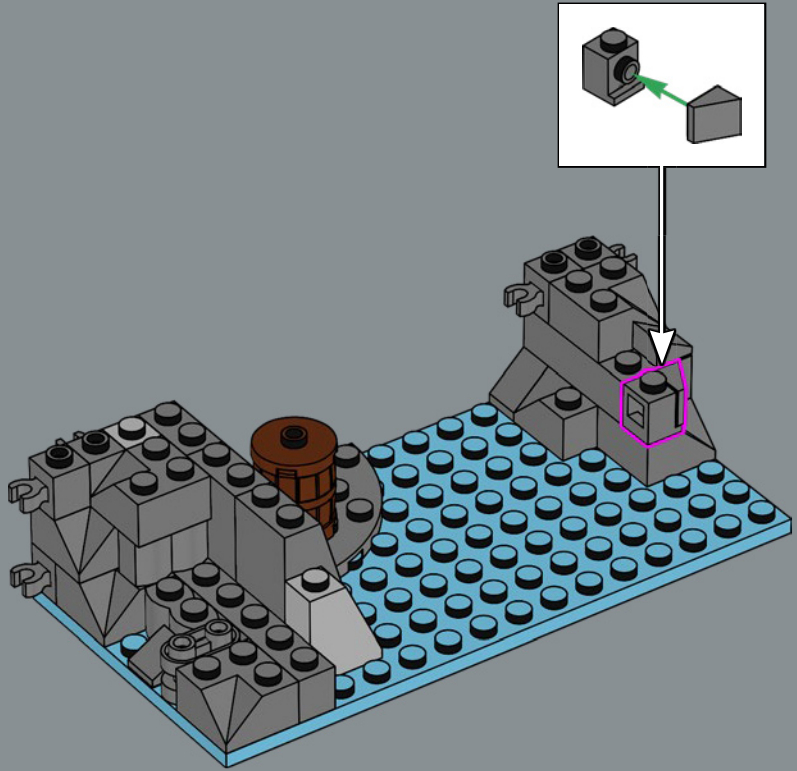
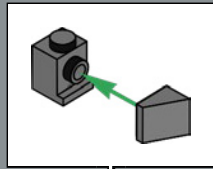

59

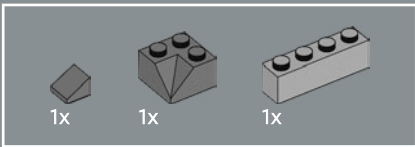
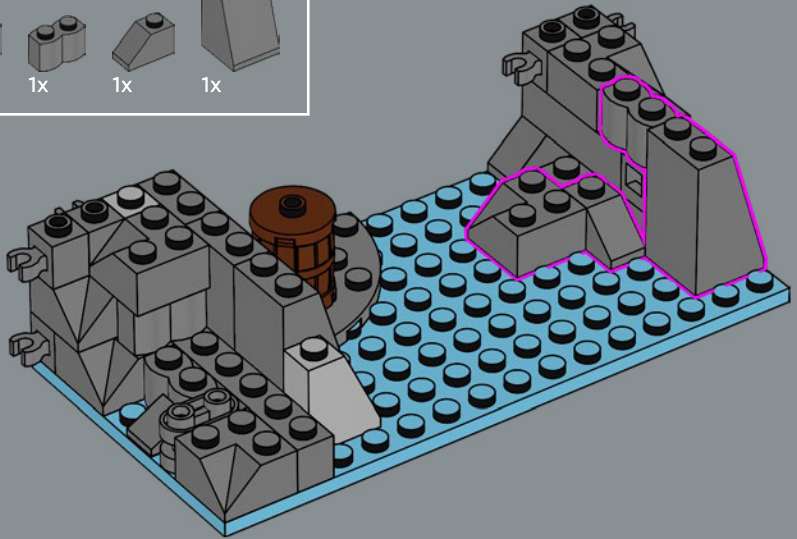

60

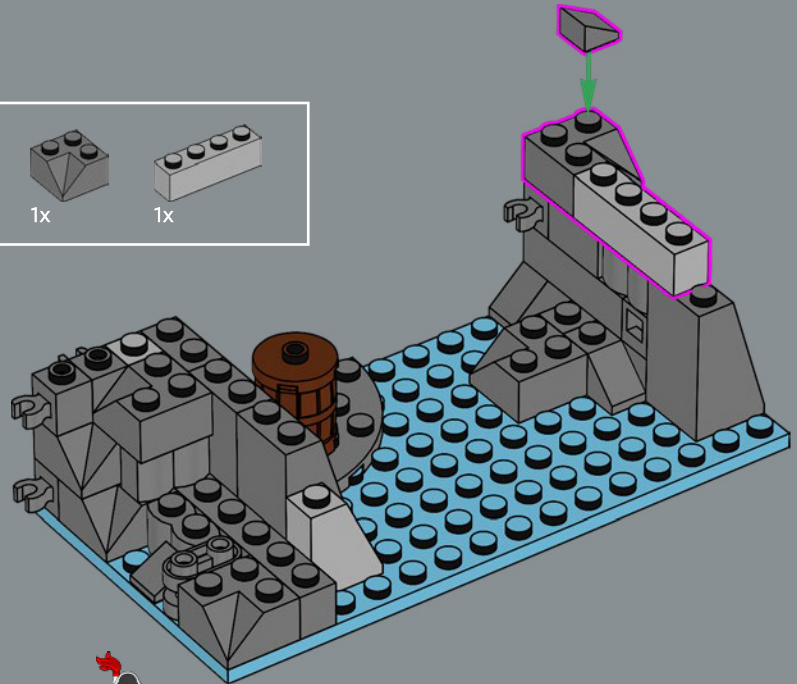

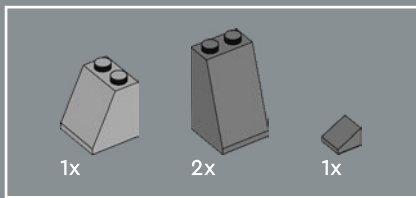

61

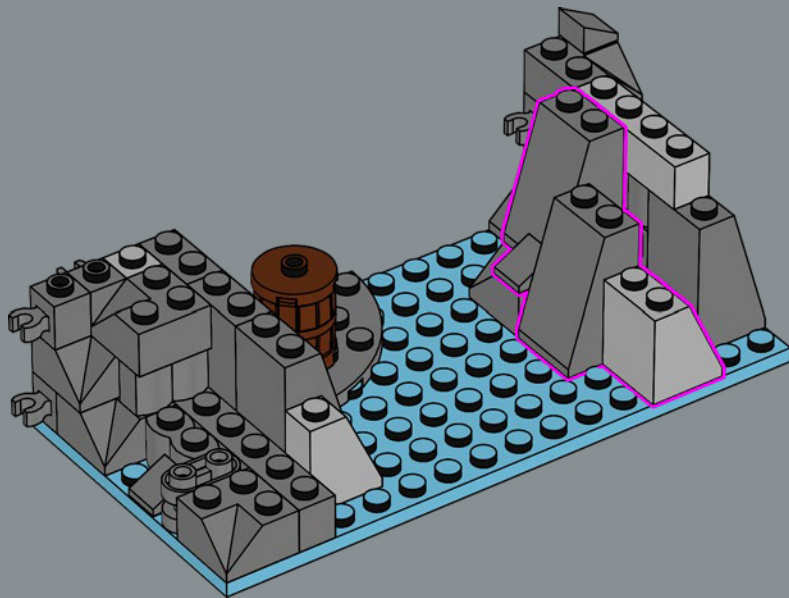

62

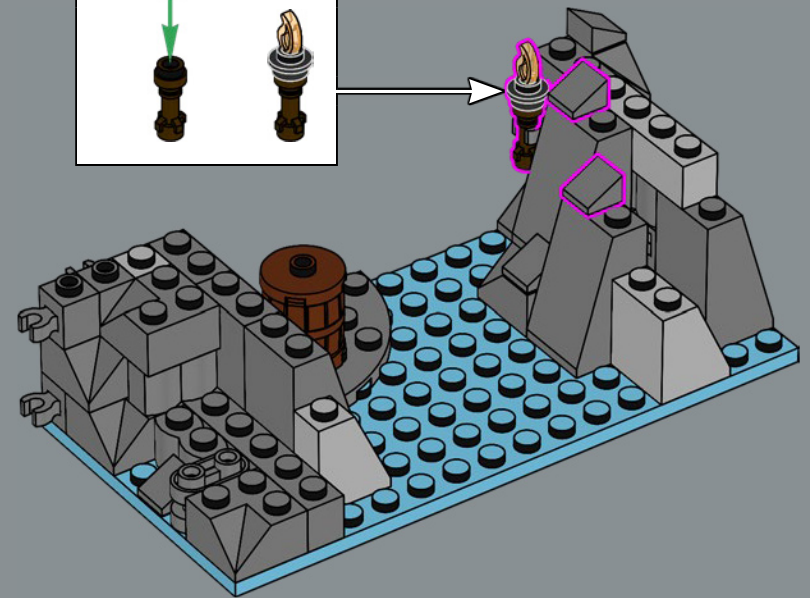
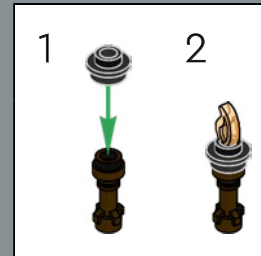

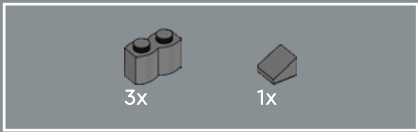

63

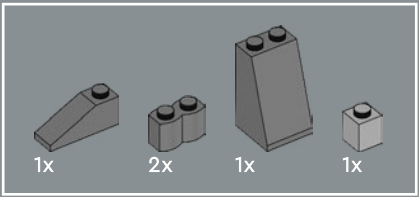
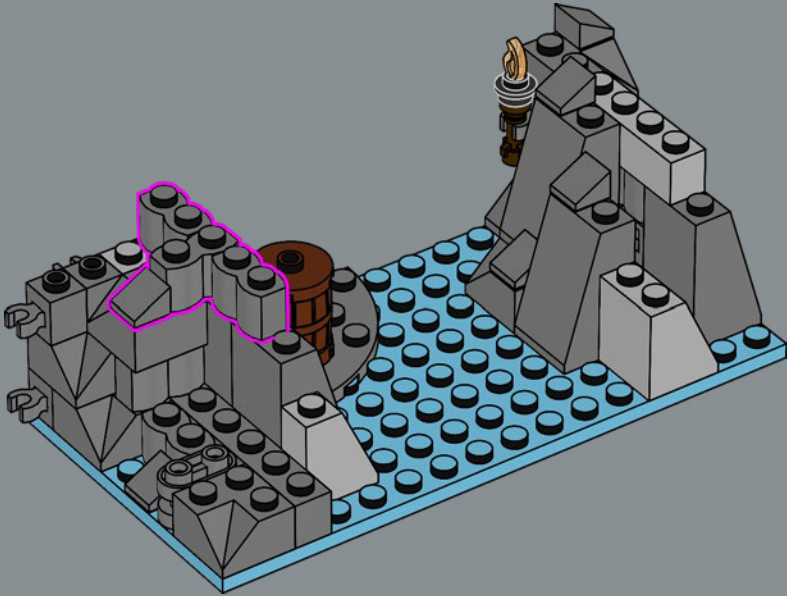

64

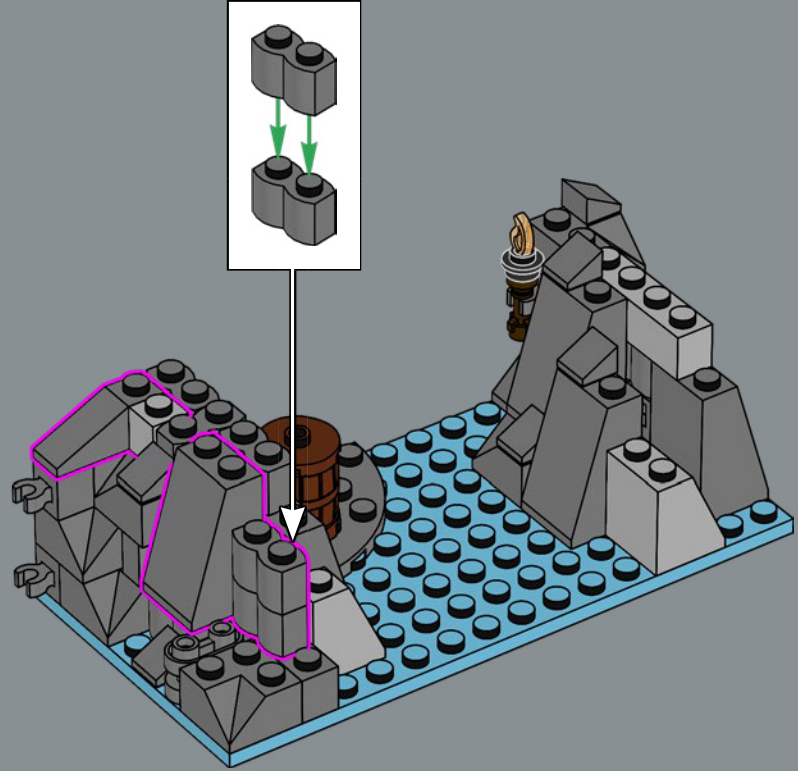

65

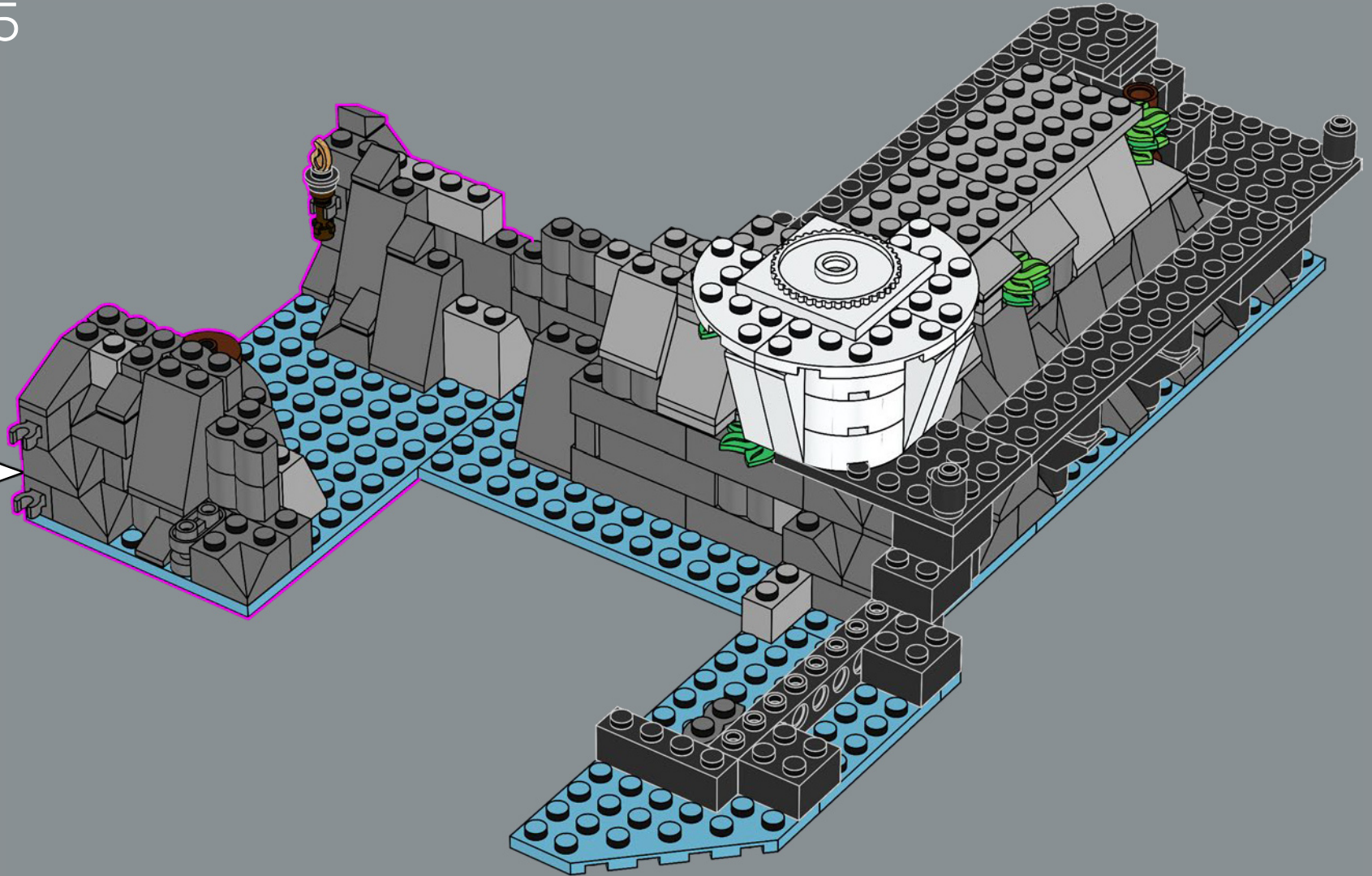

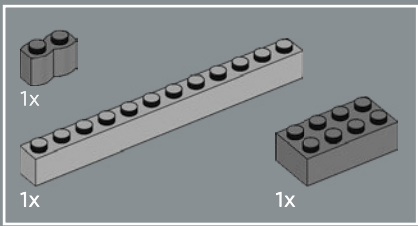

66

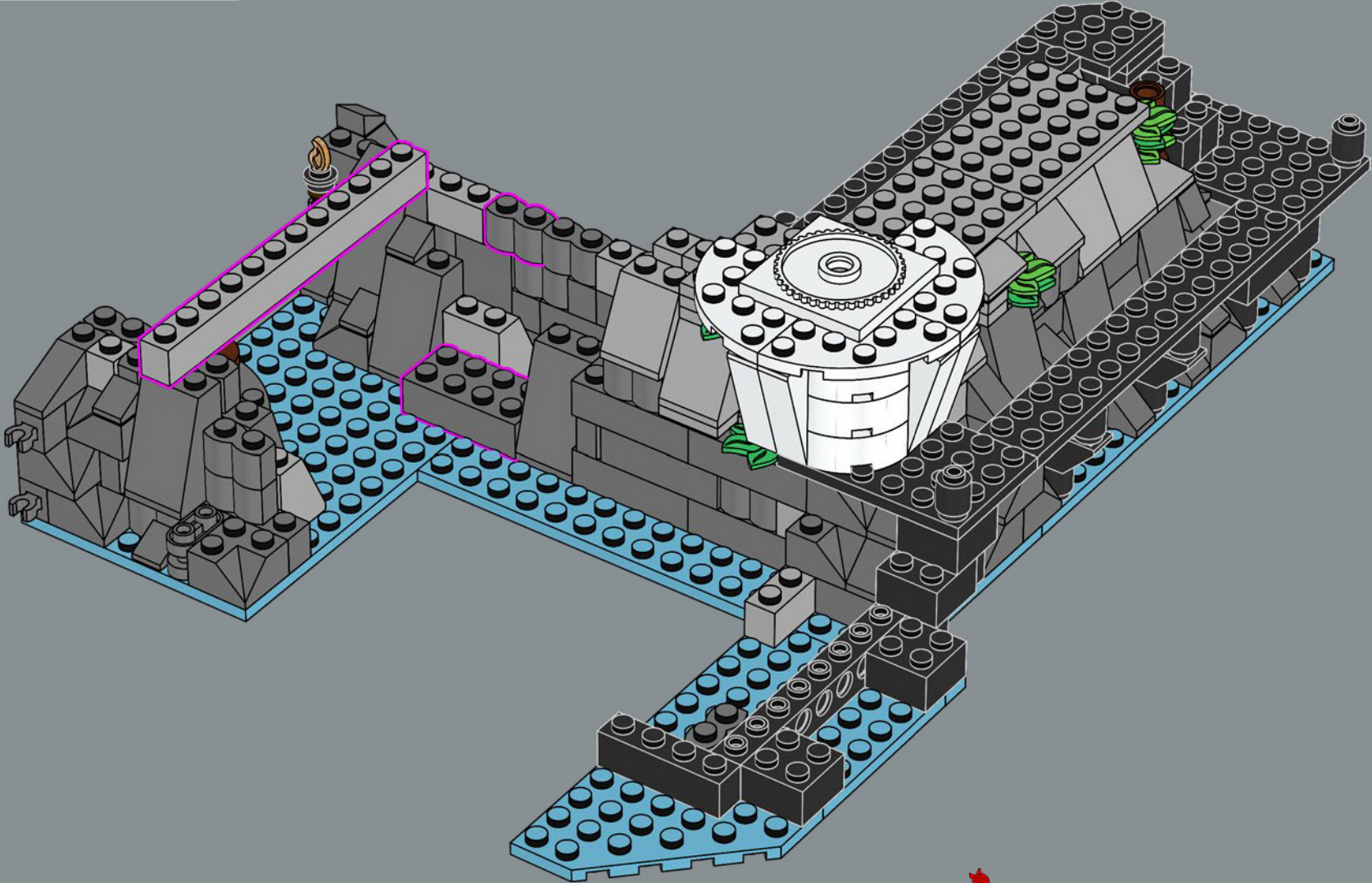

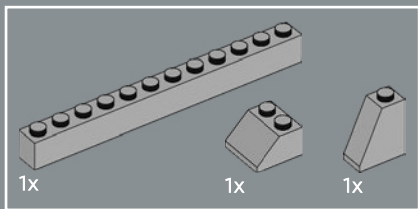

67

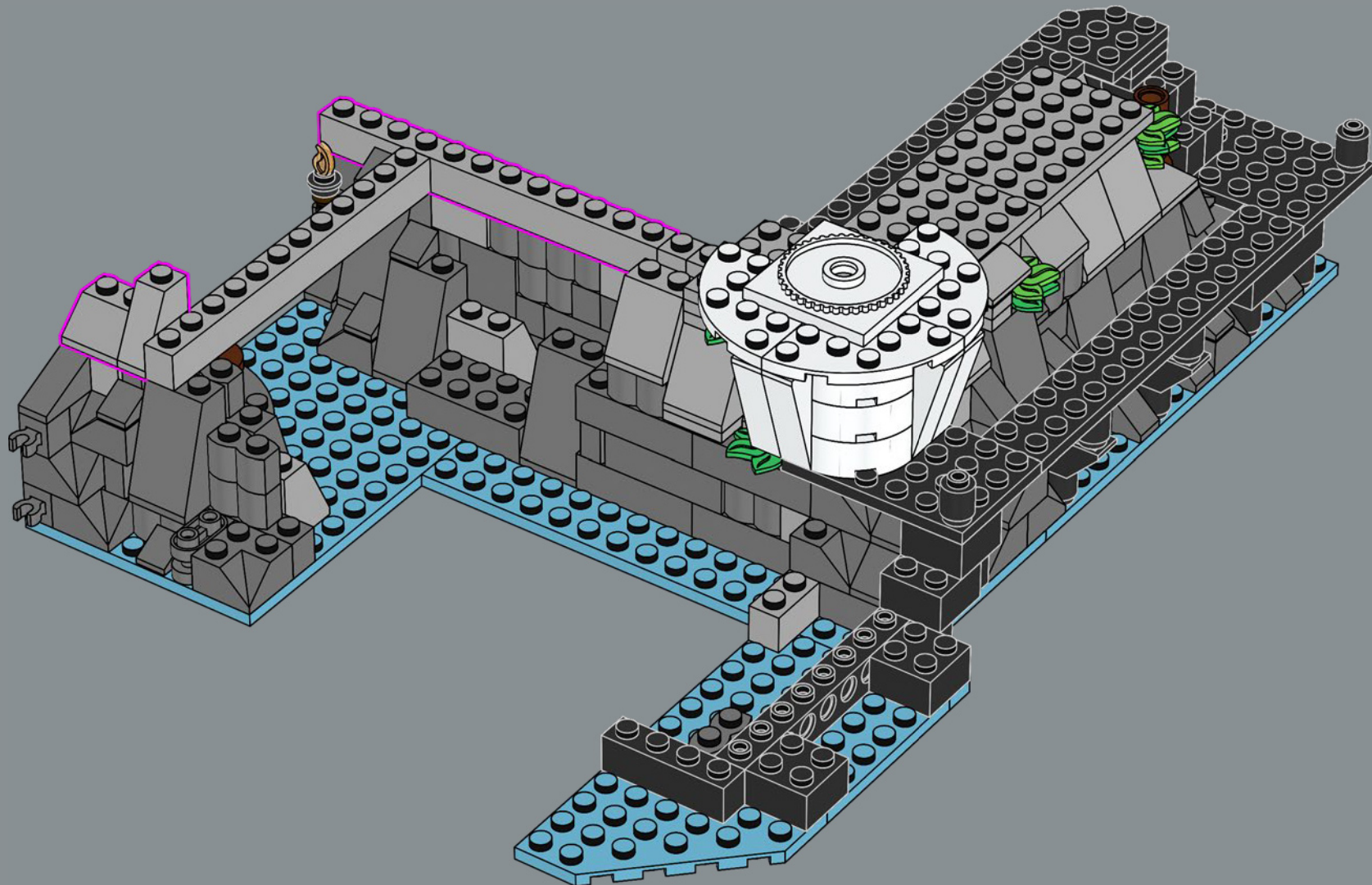

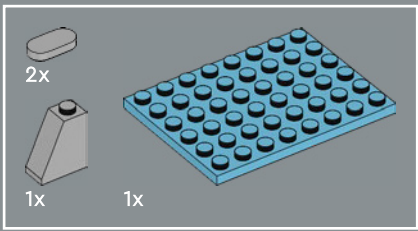

68

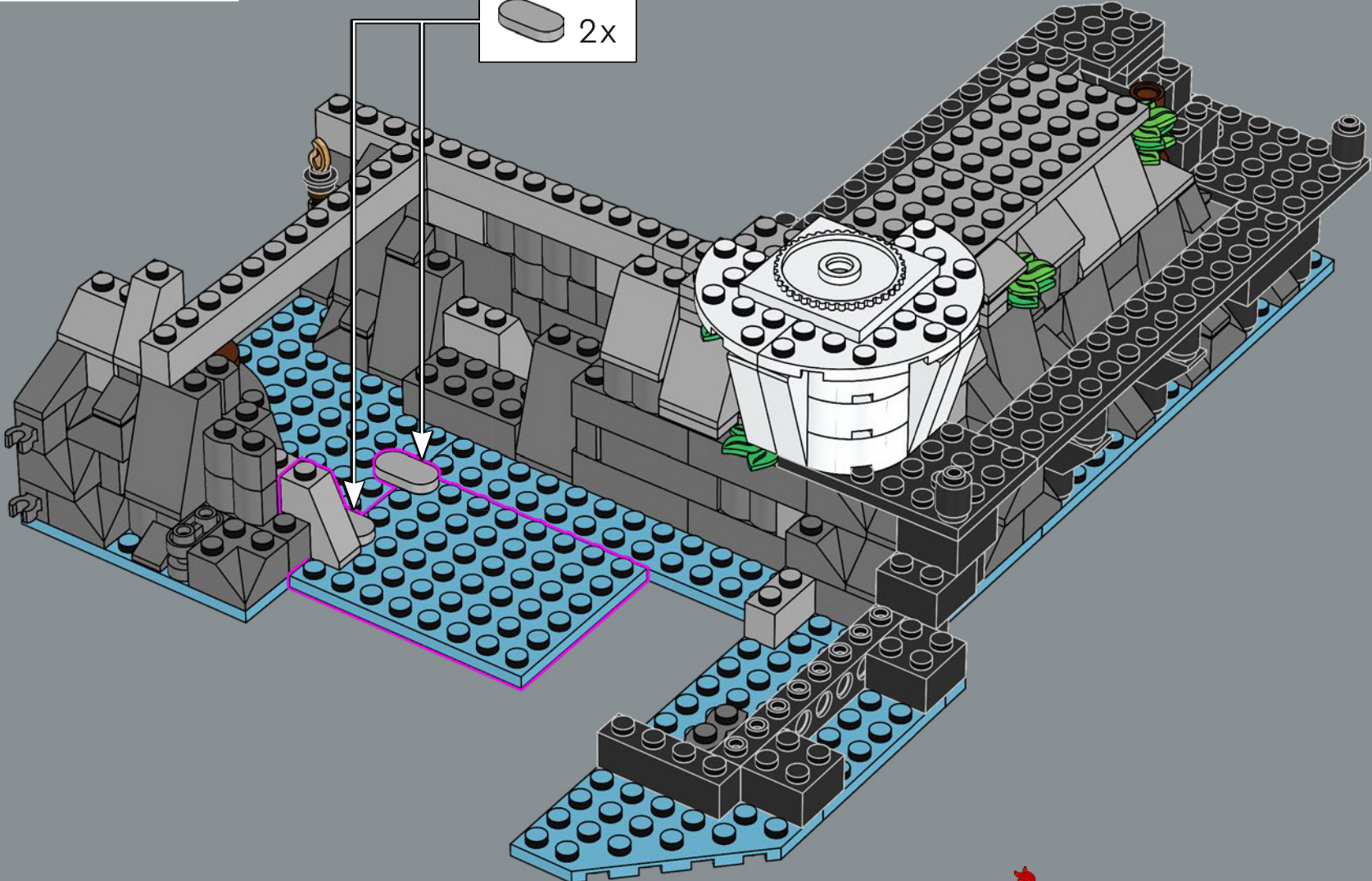

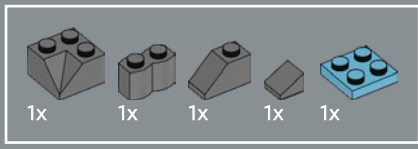

69

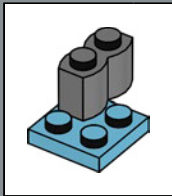
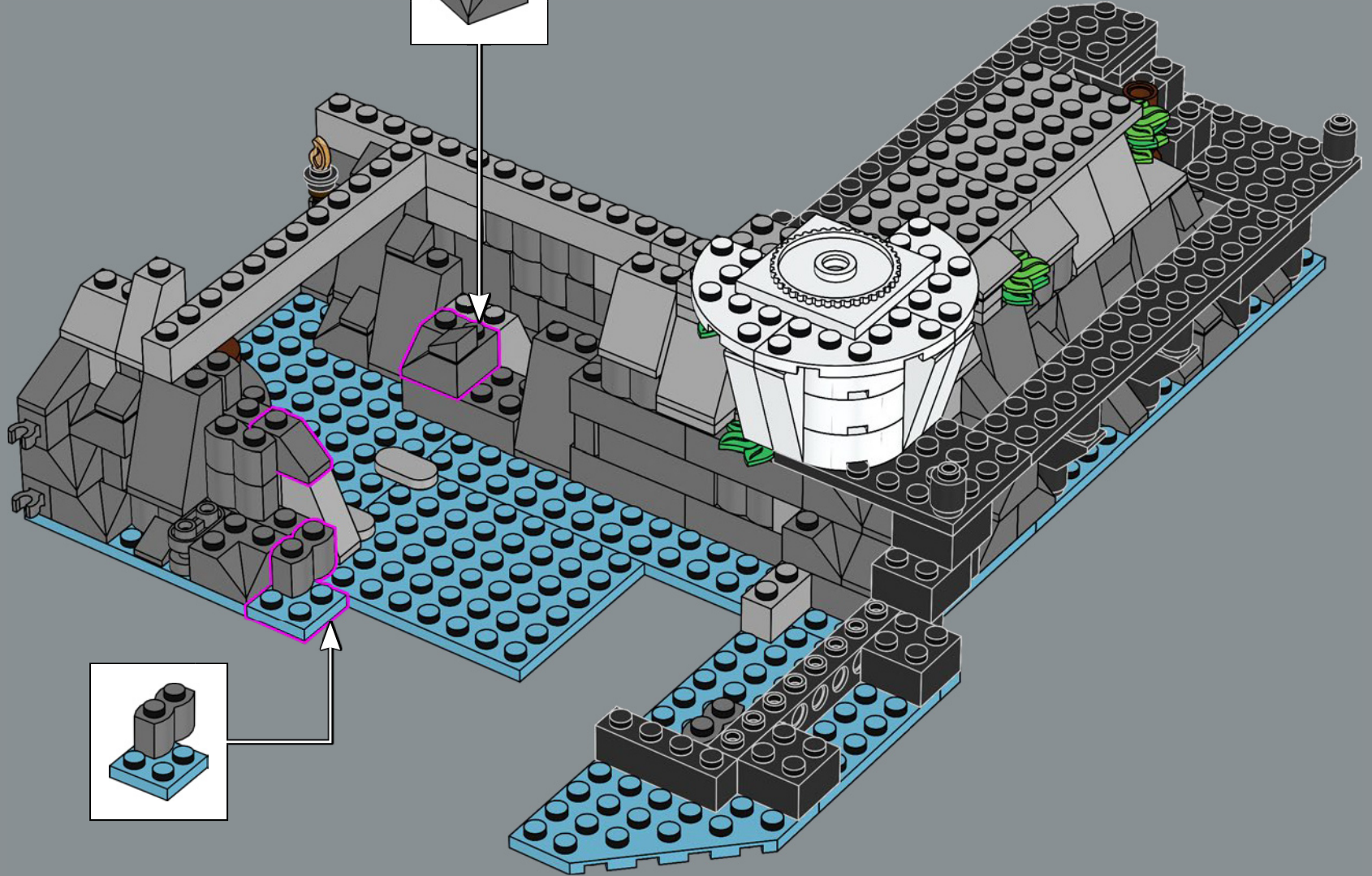
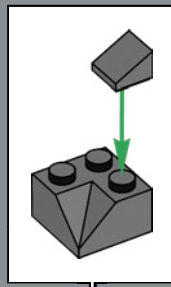

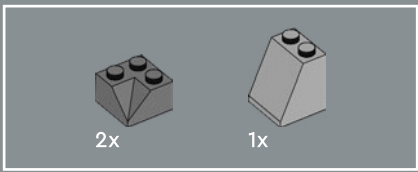

70

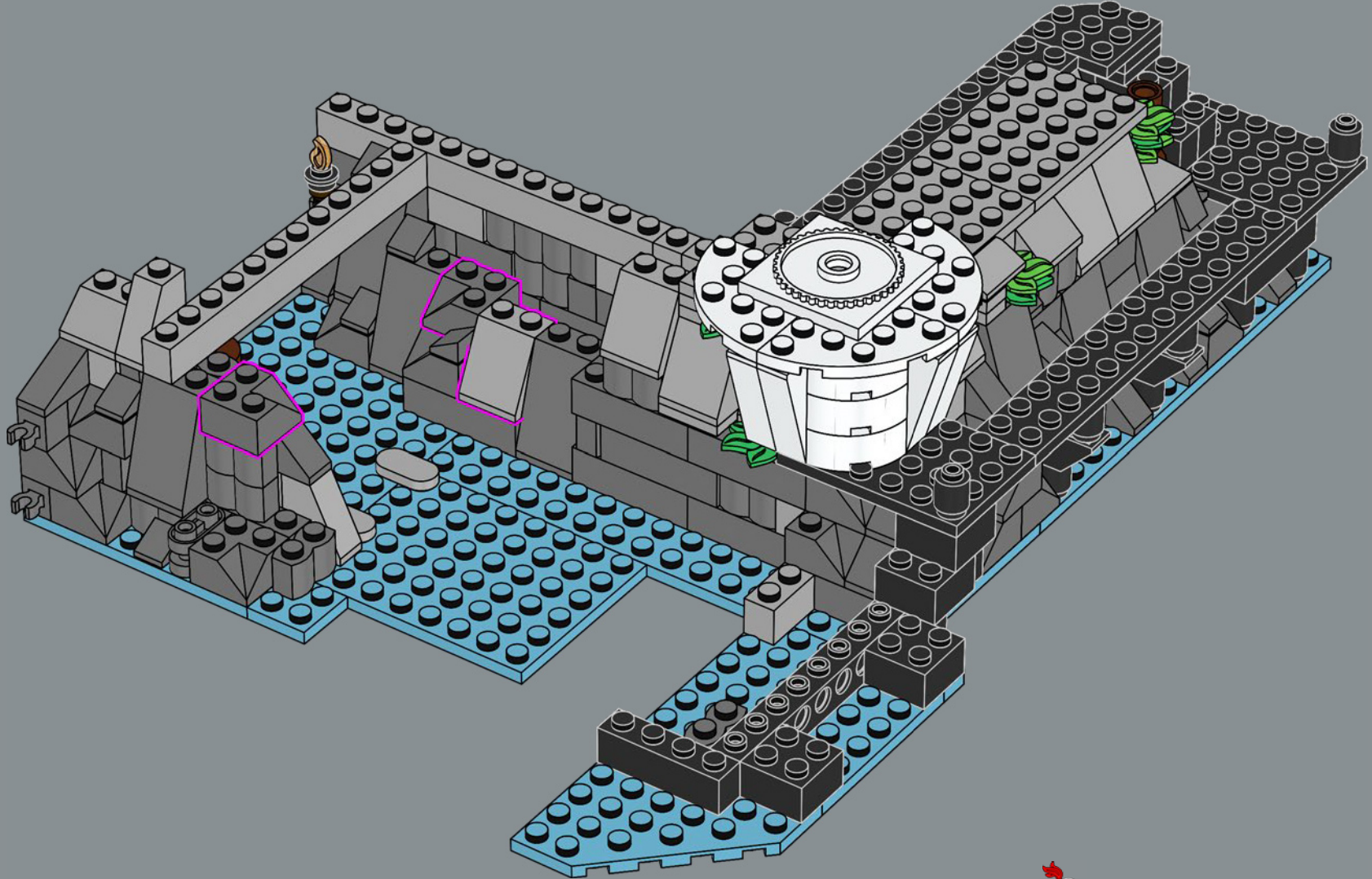

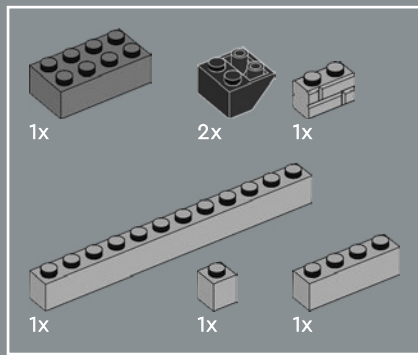

71

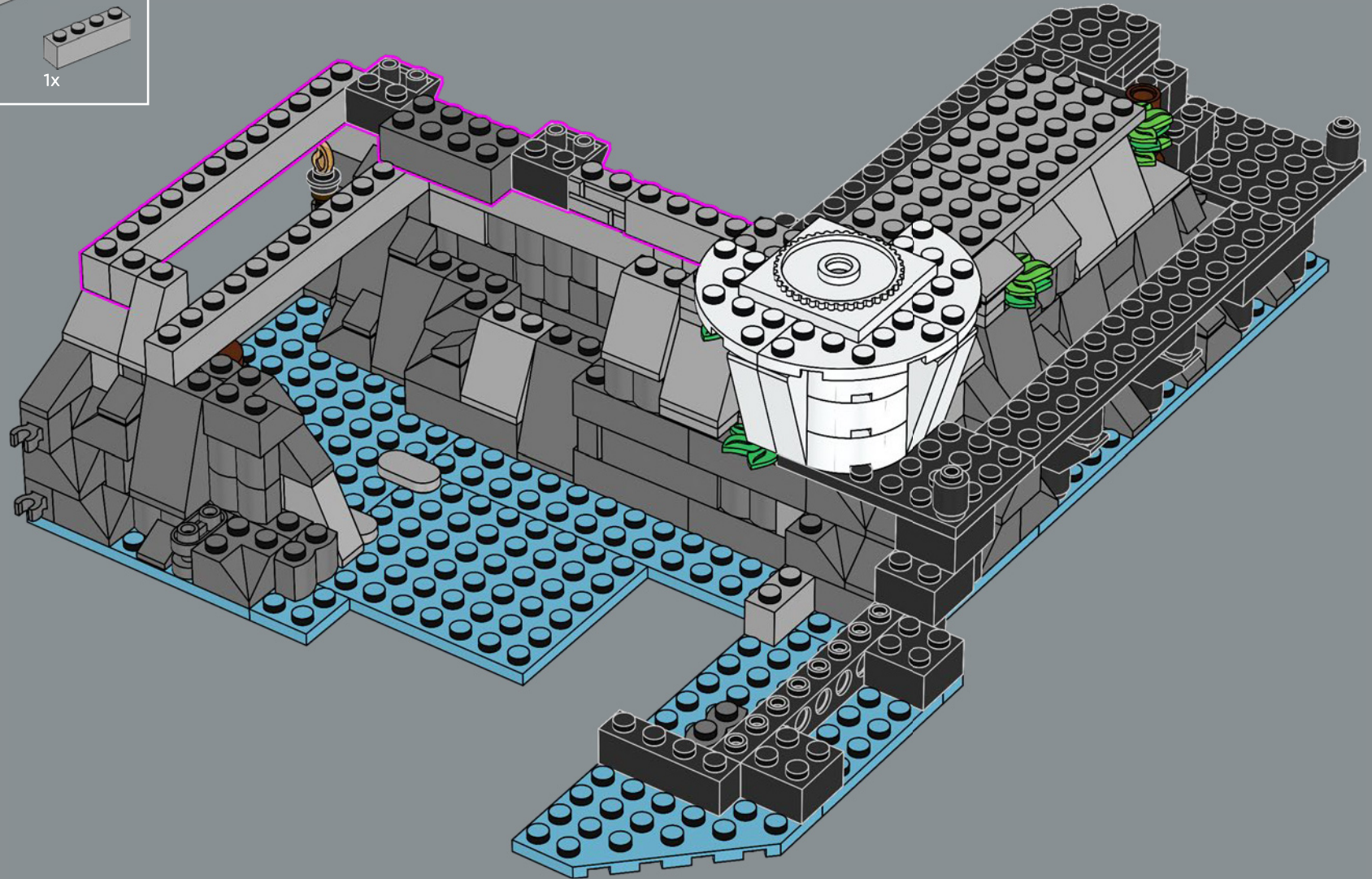

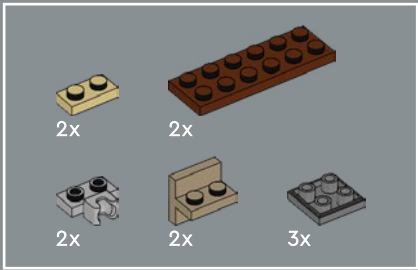

72

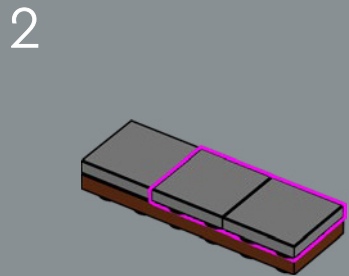
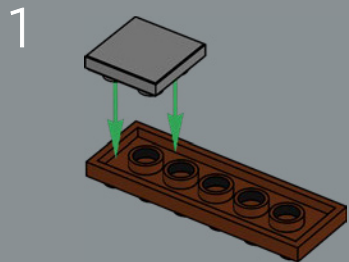

3

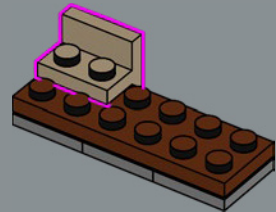

4

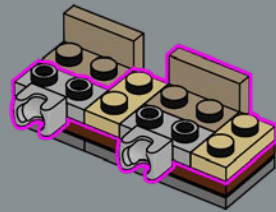

5

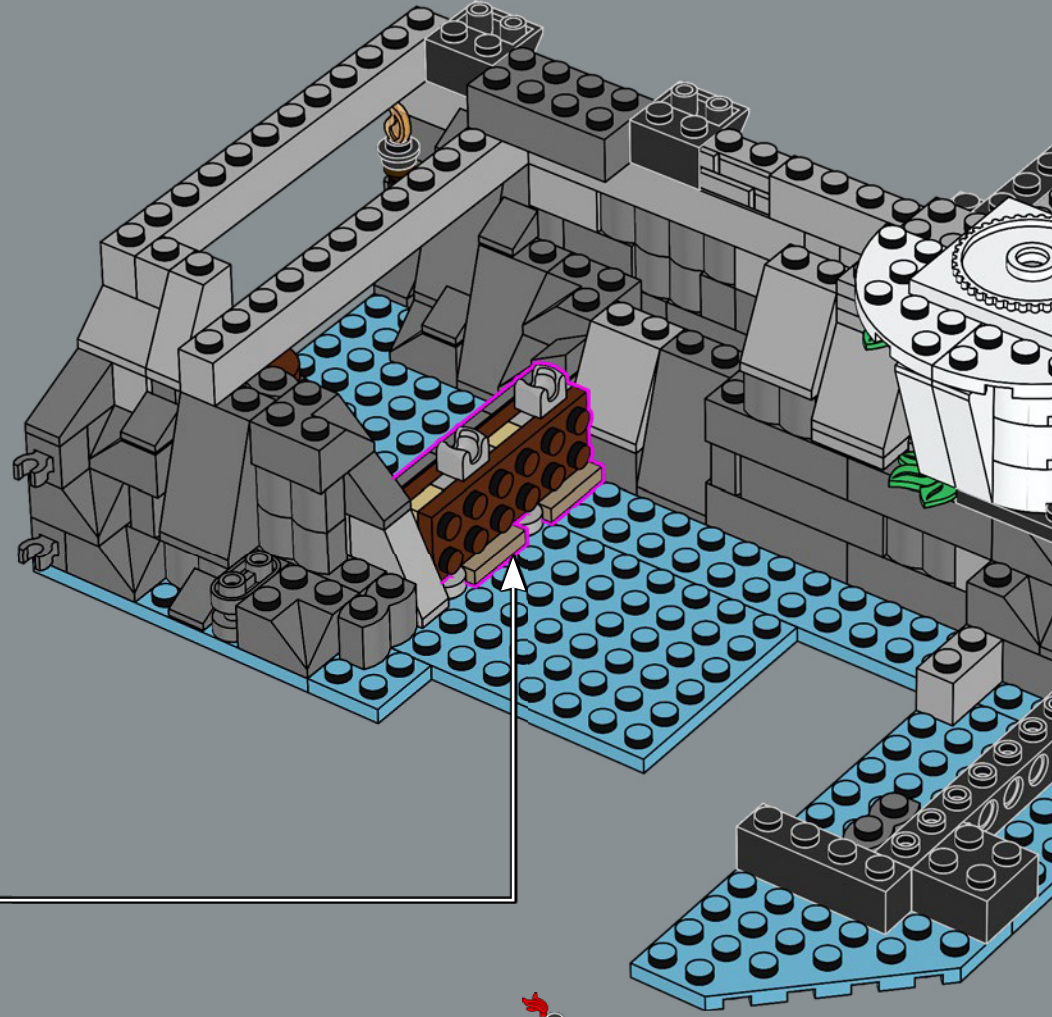
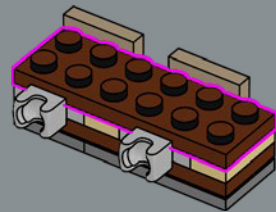

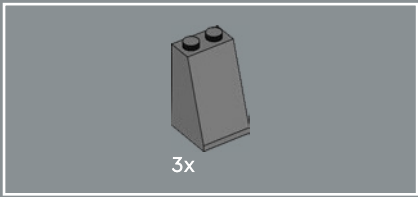

73

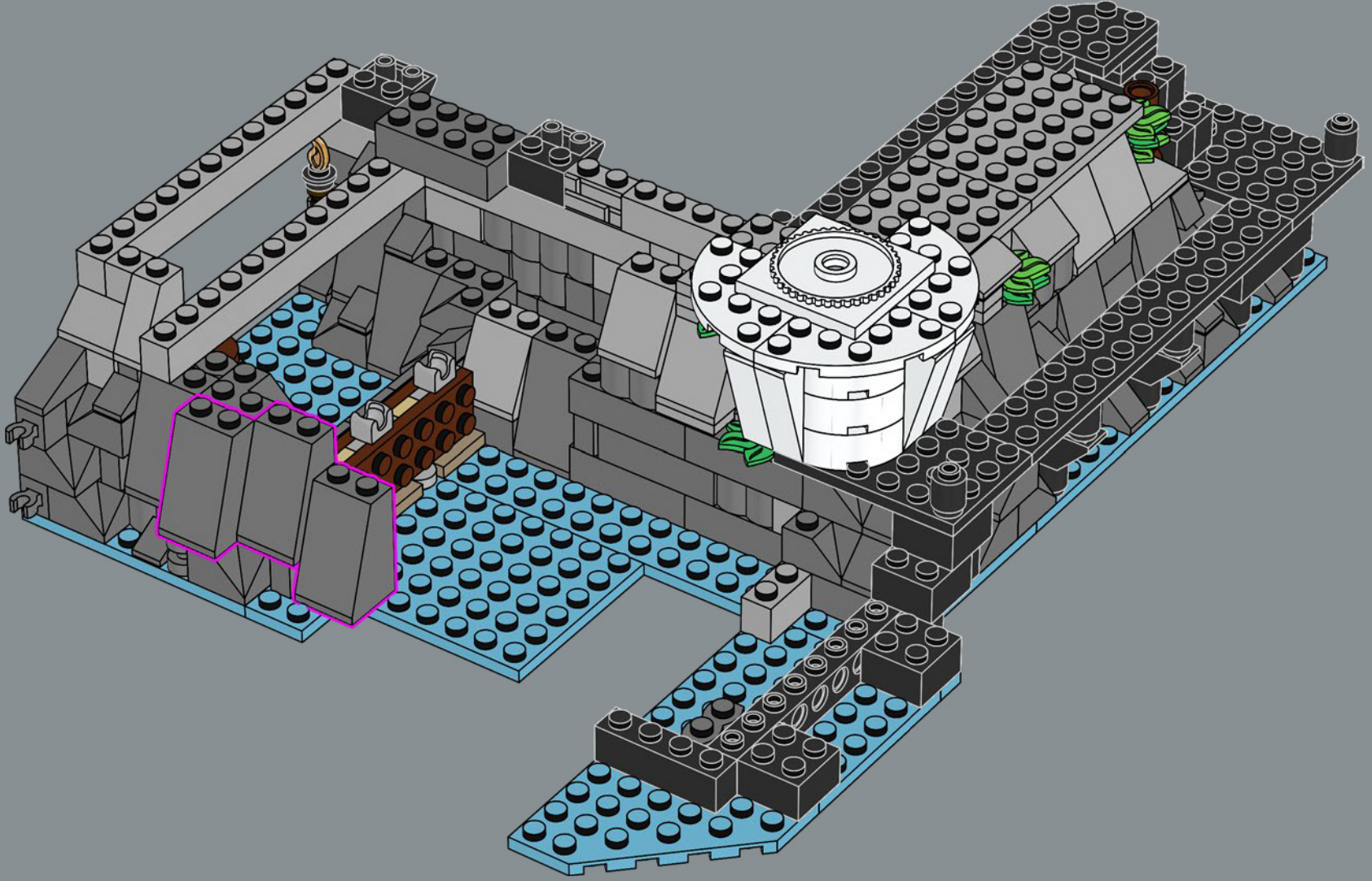

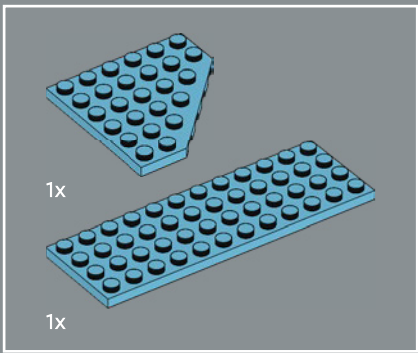

74

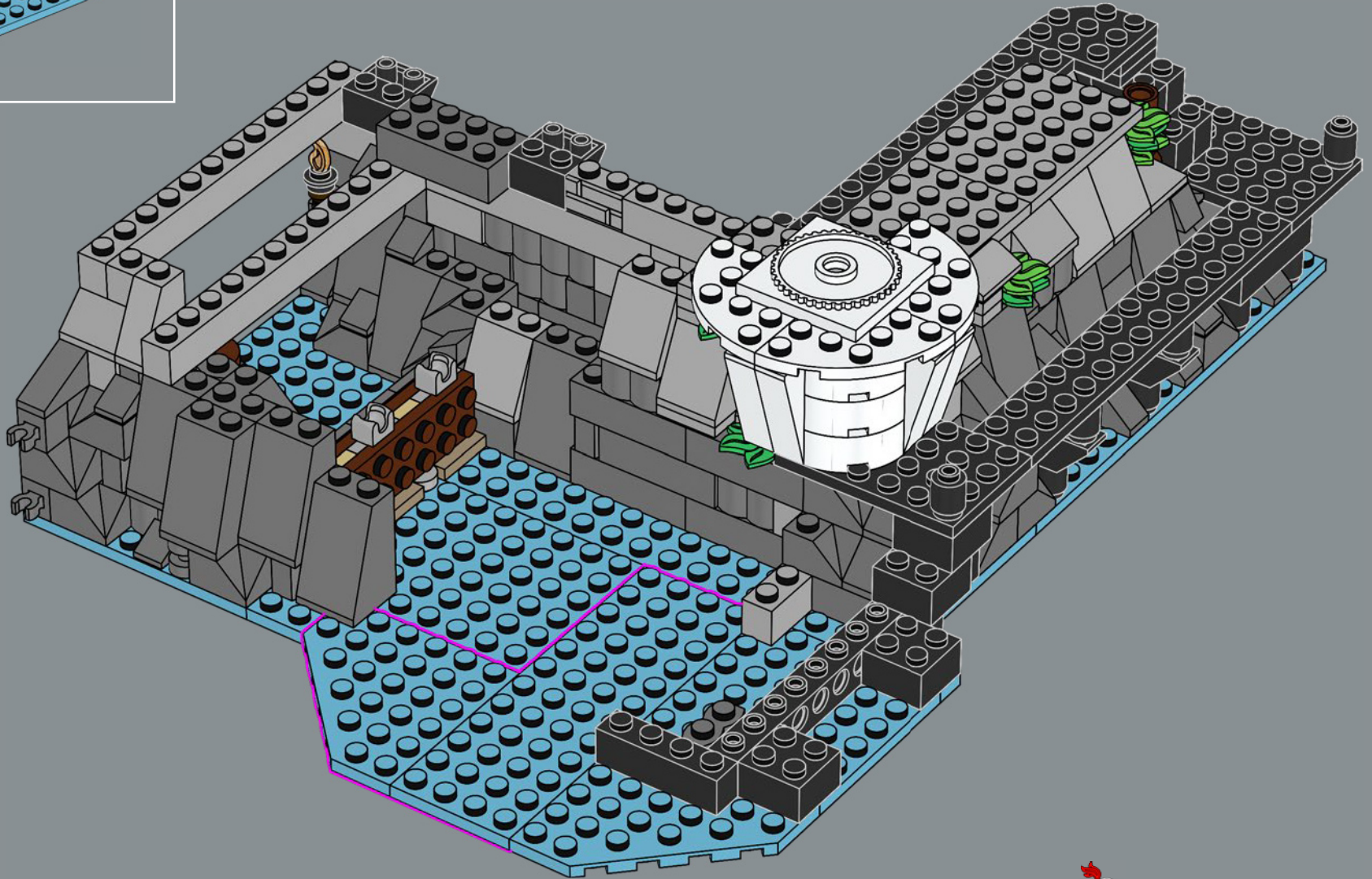

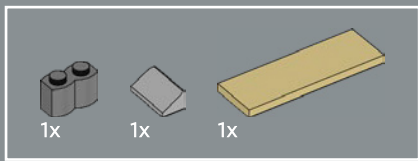

75

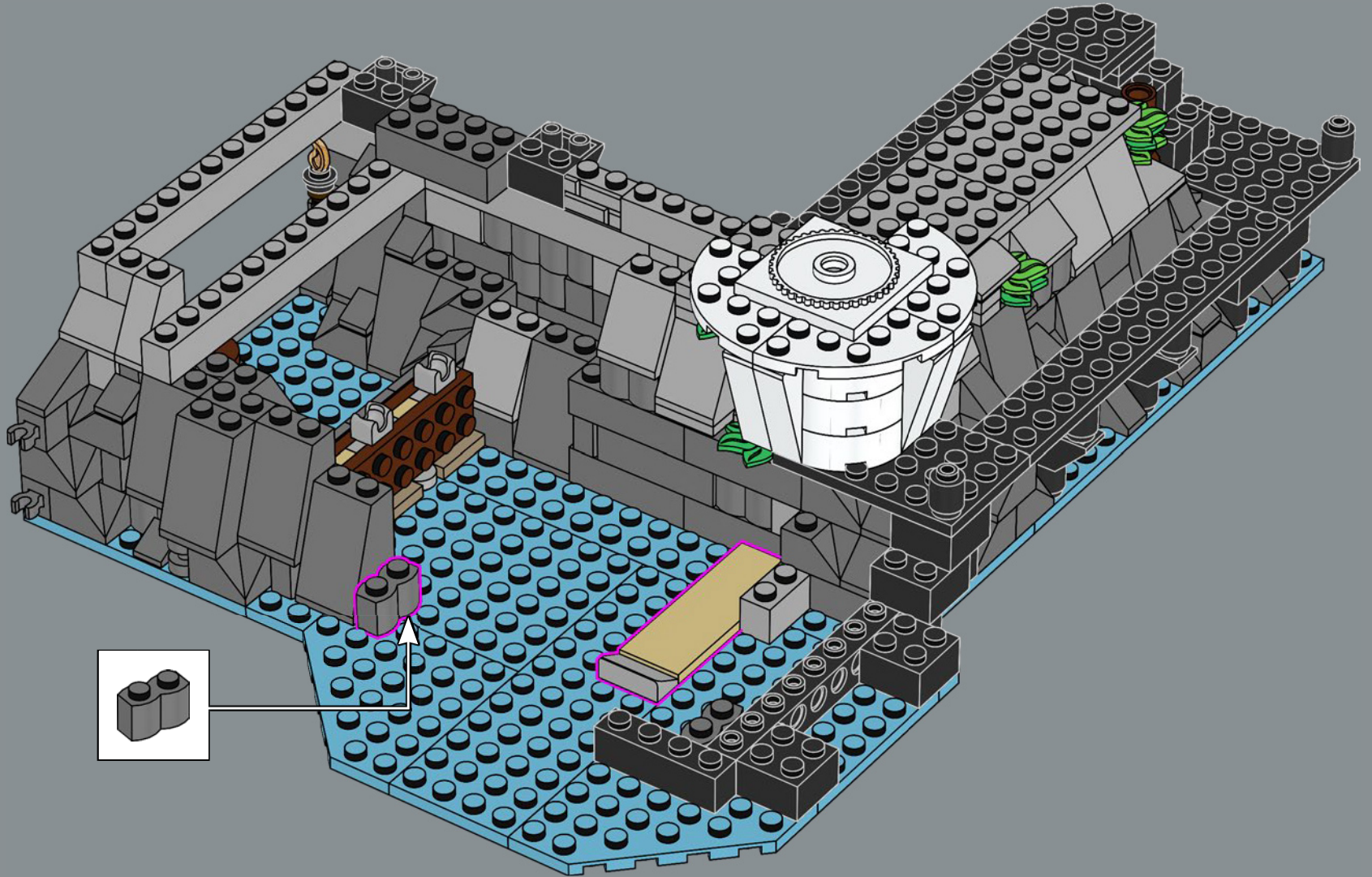

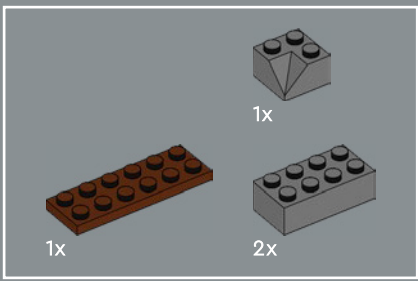

76

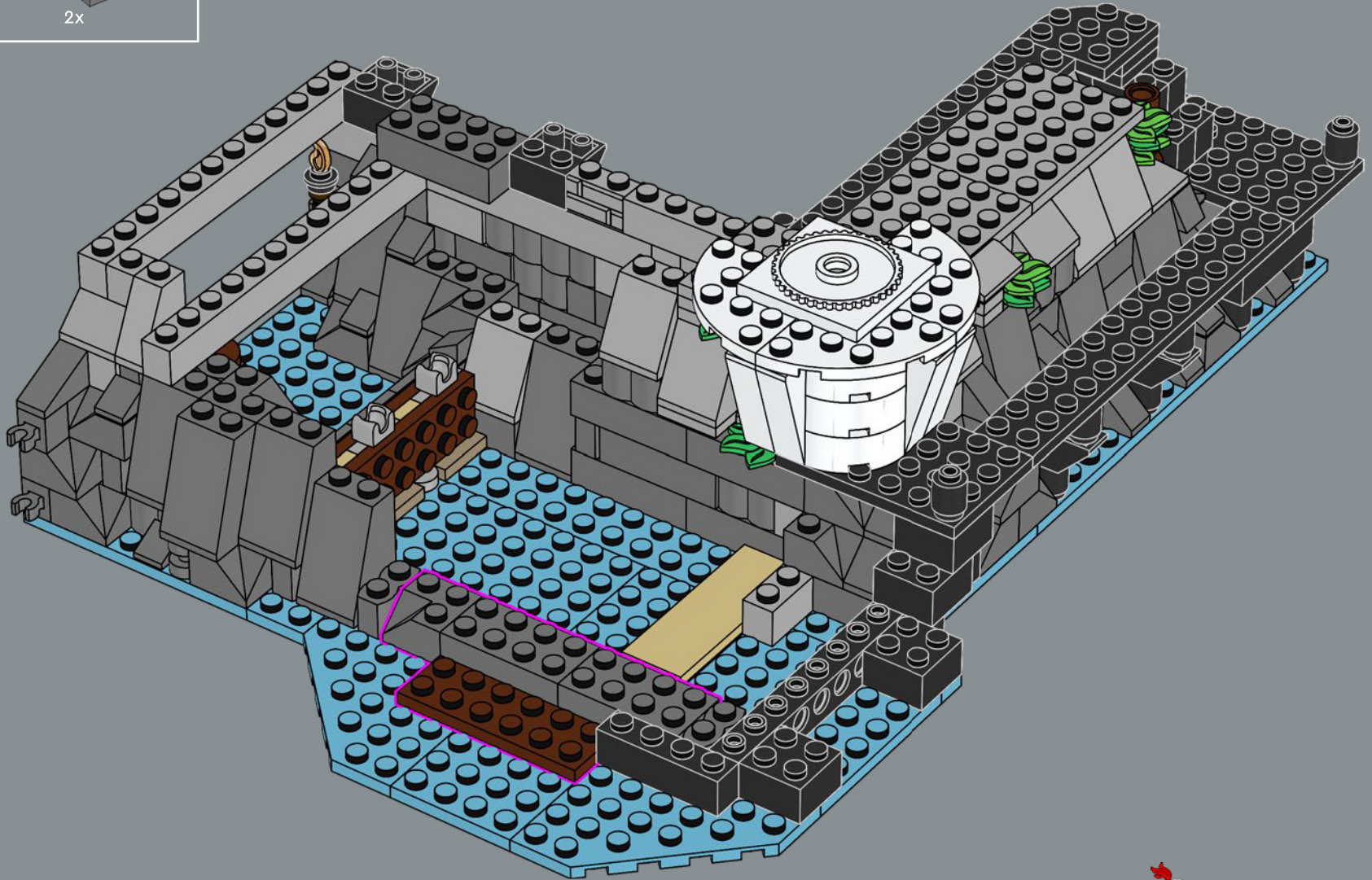

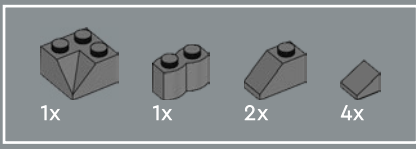

77

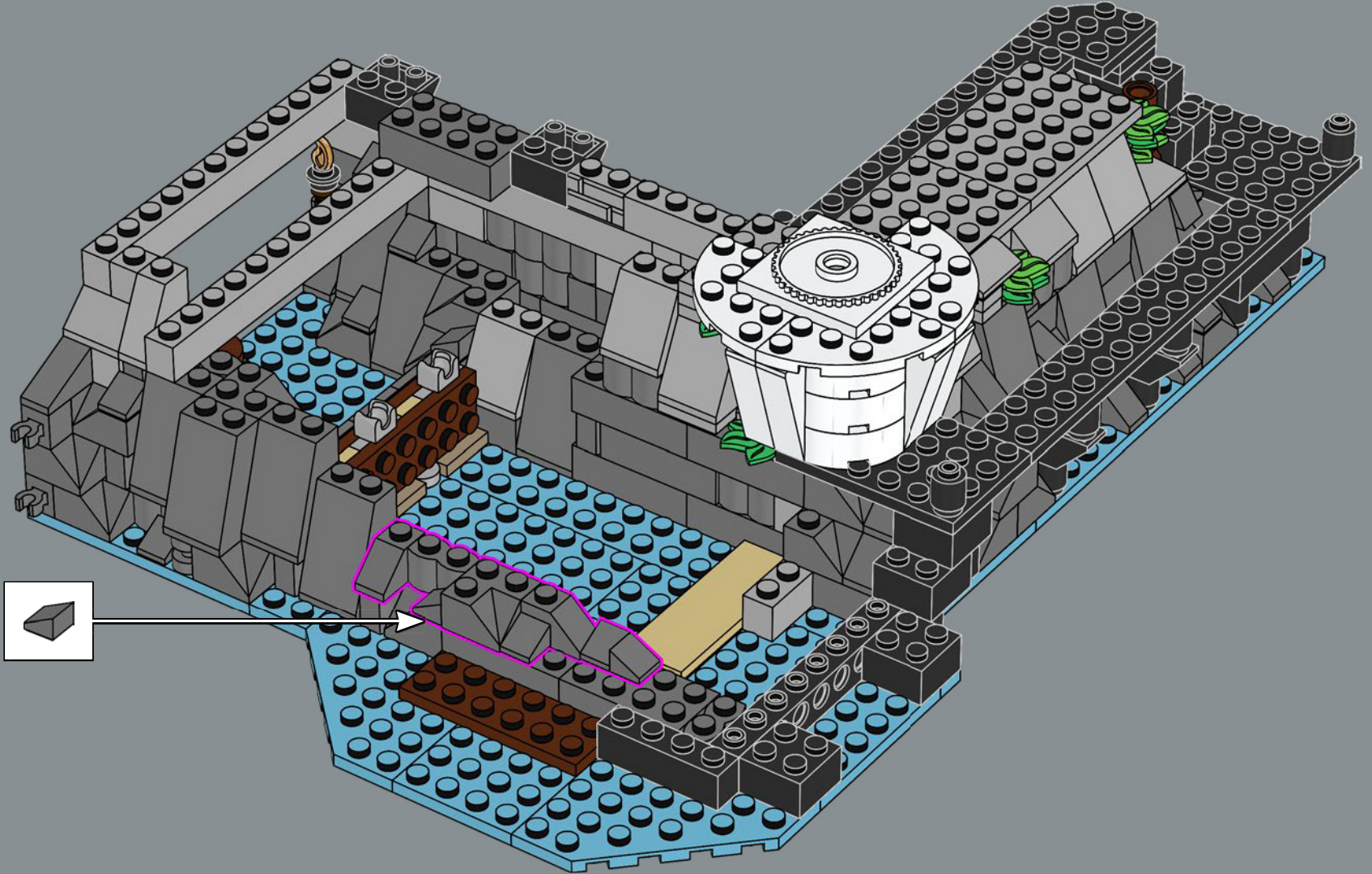

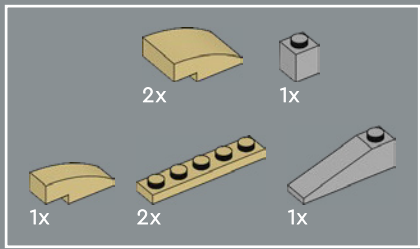

78

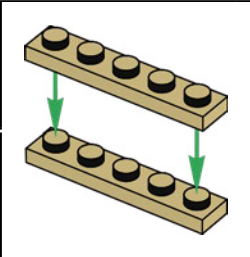
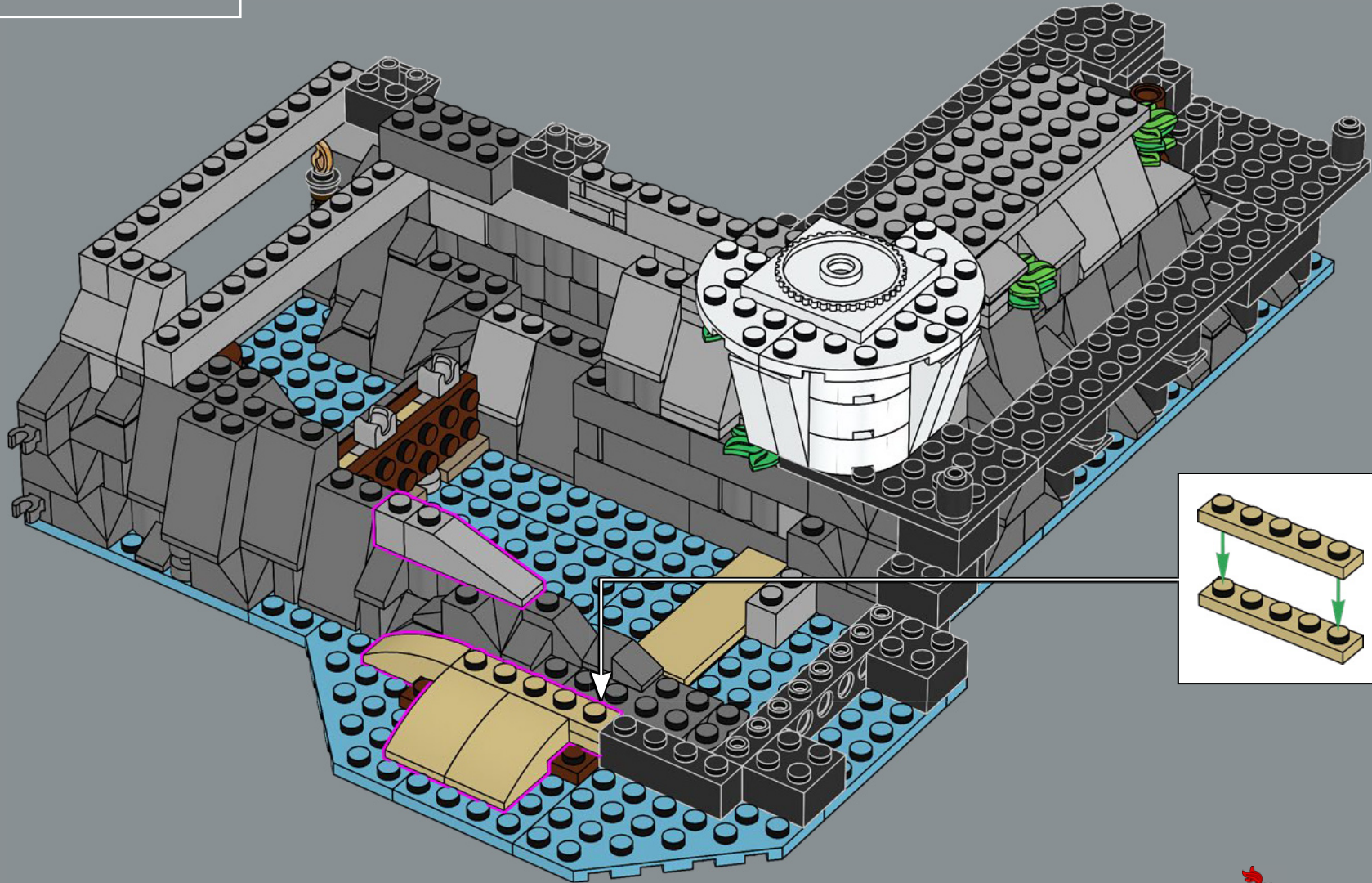

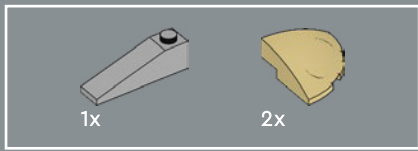

79

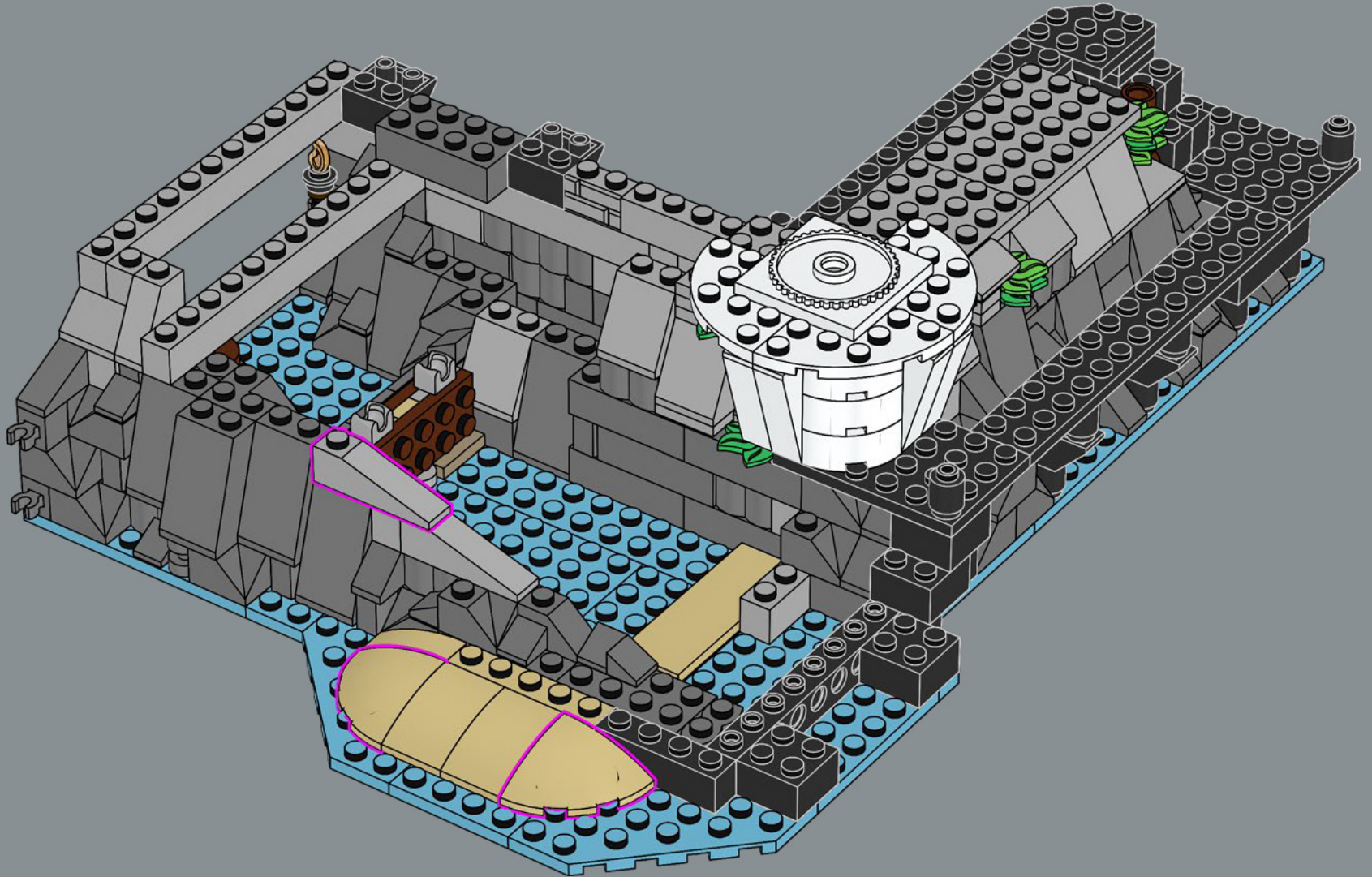

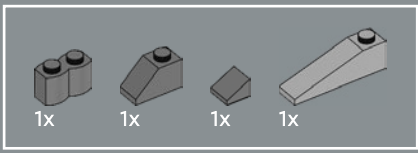

80

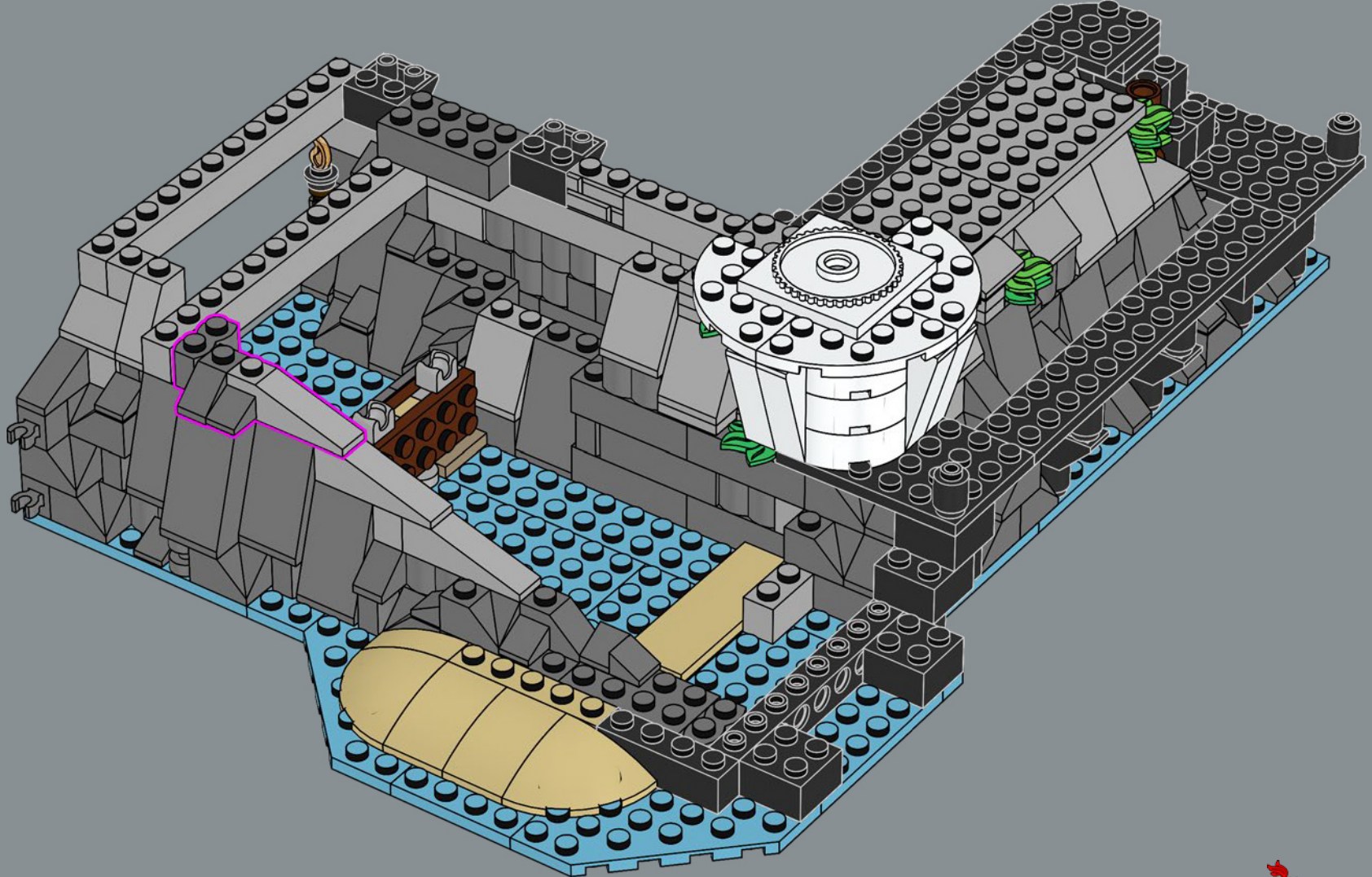

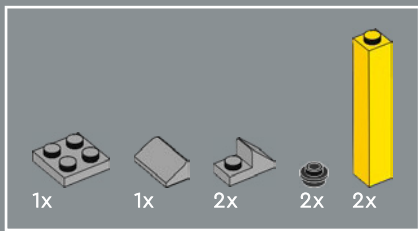

81

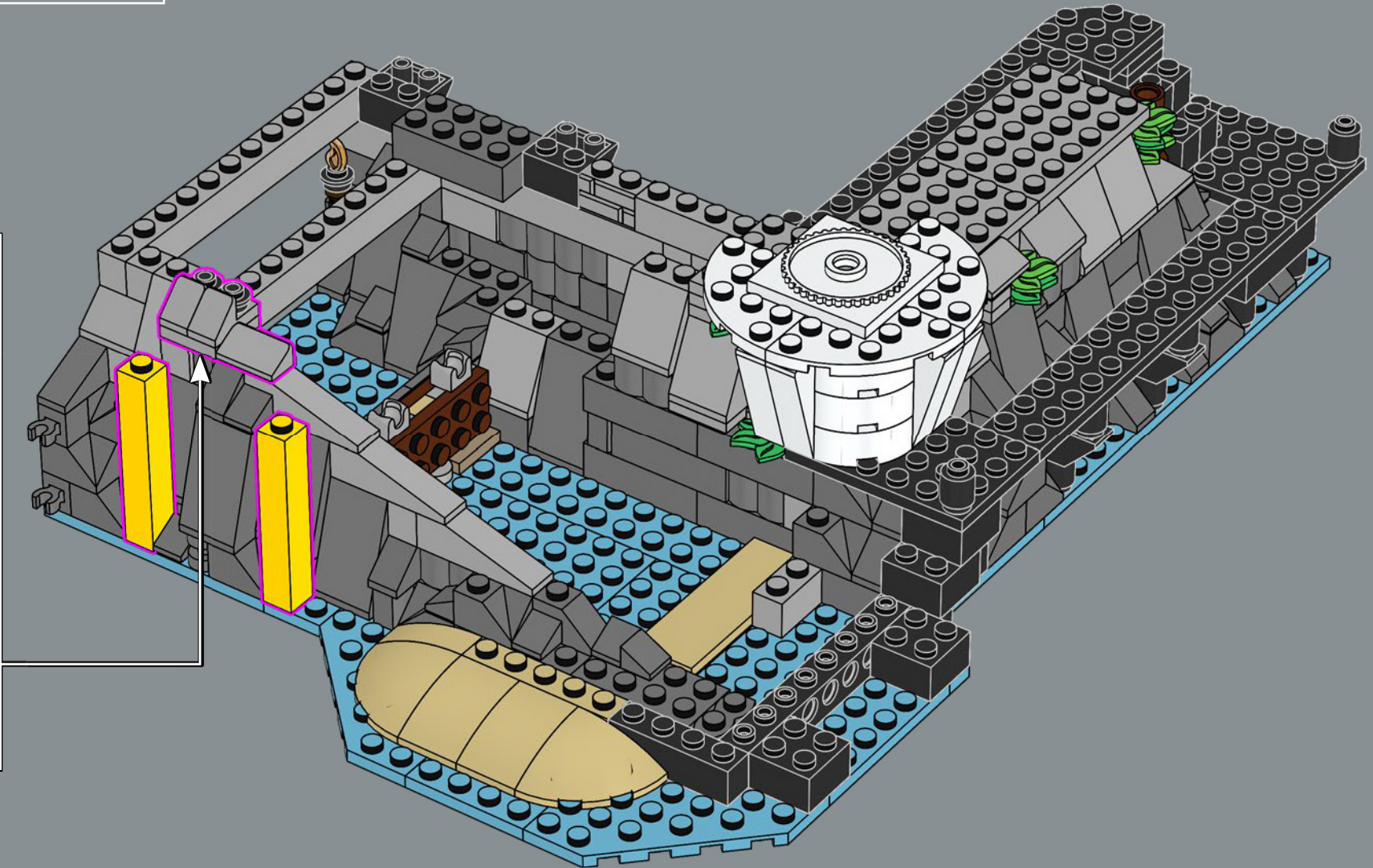
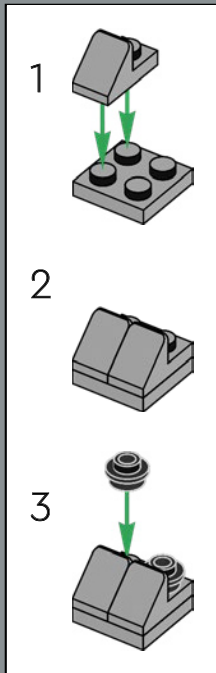

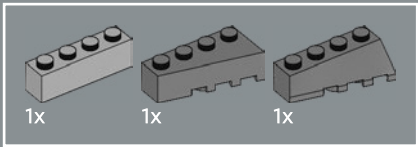

82

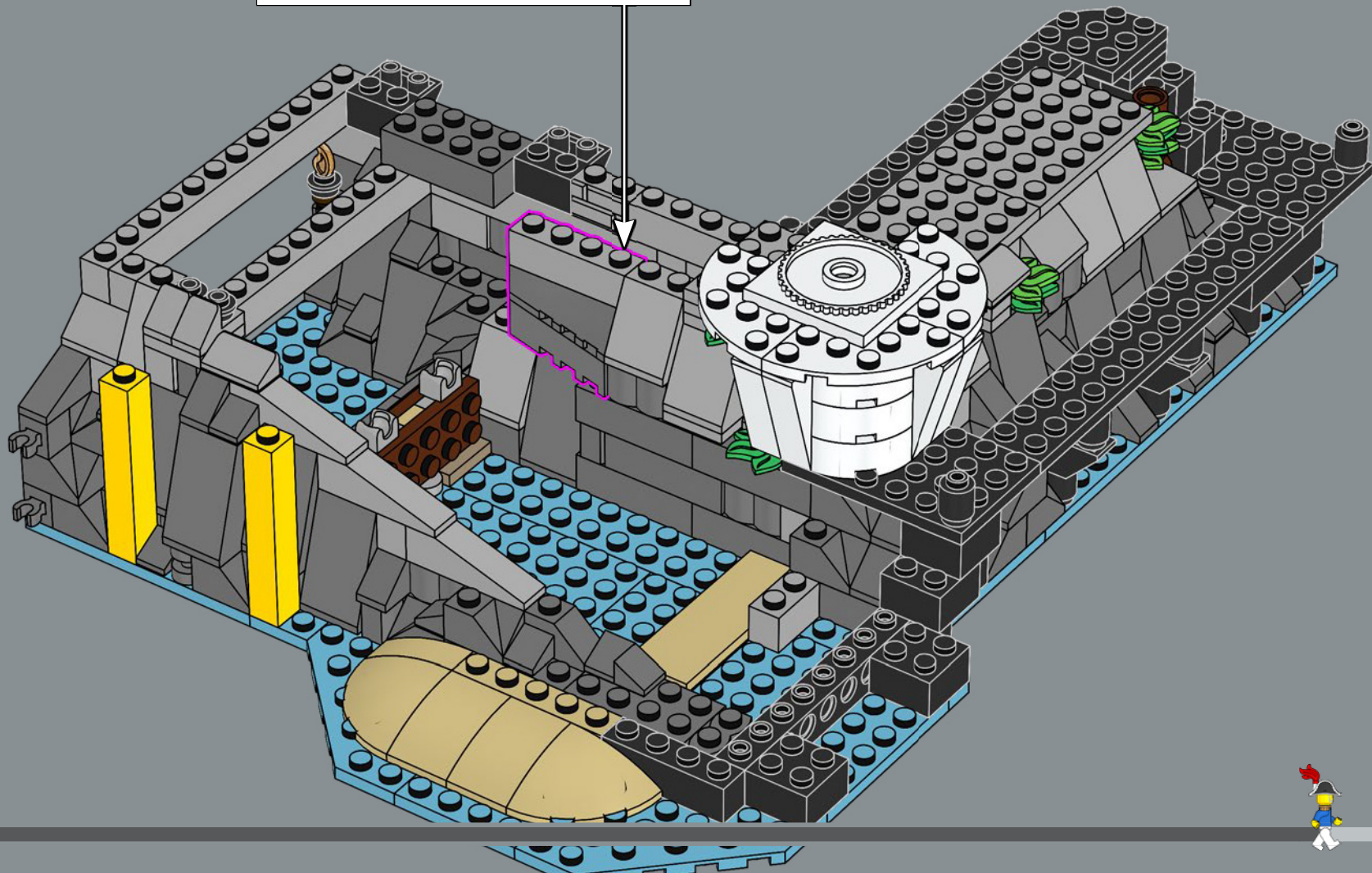
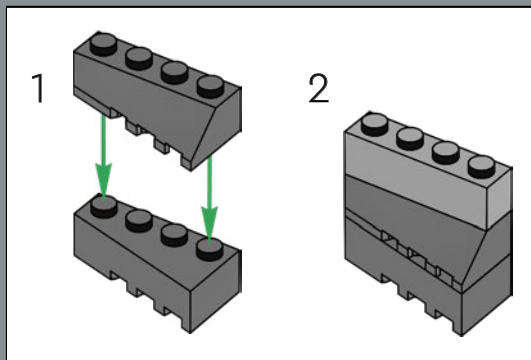

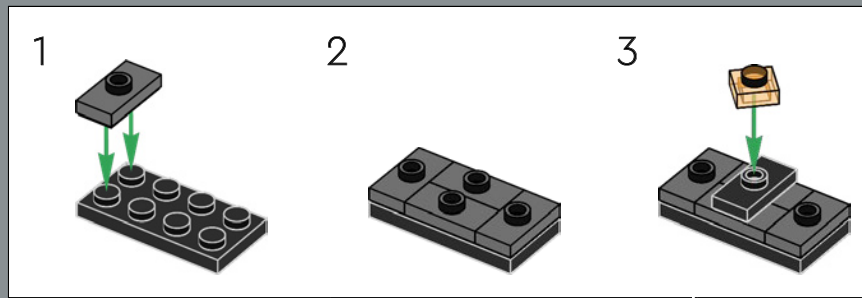
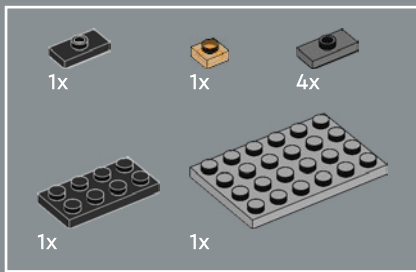

83

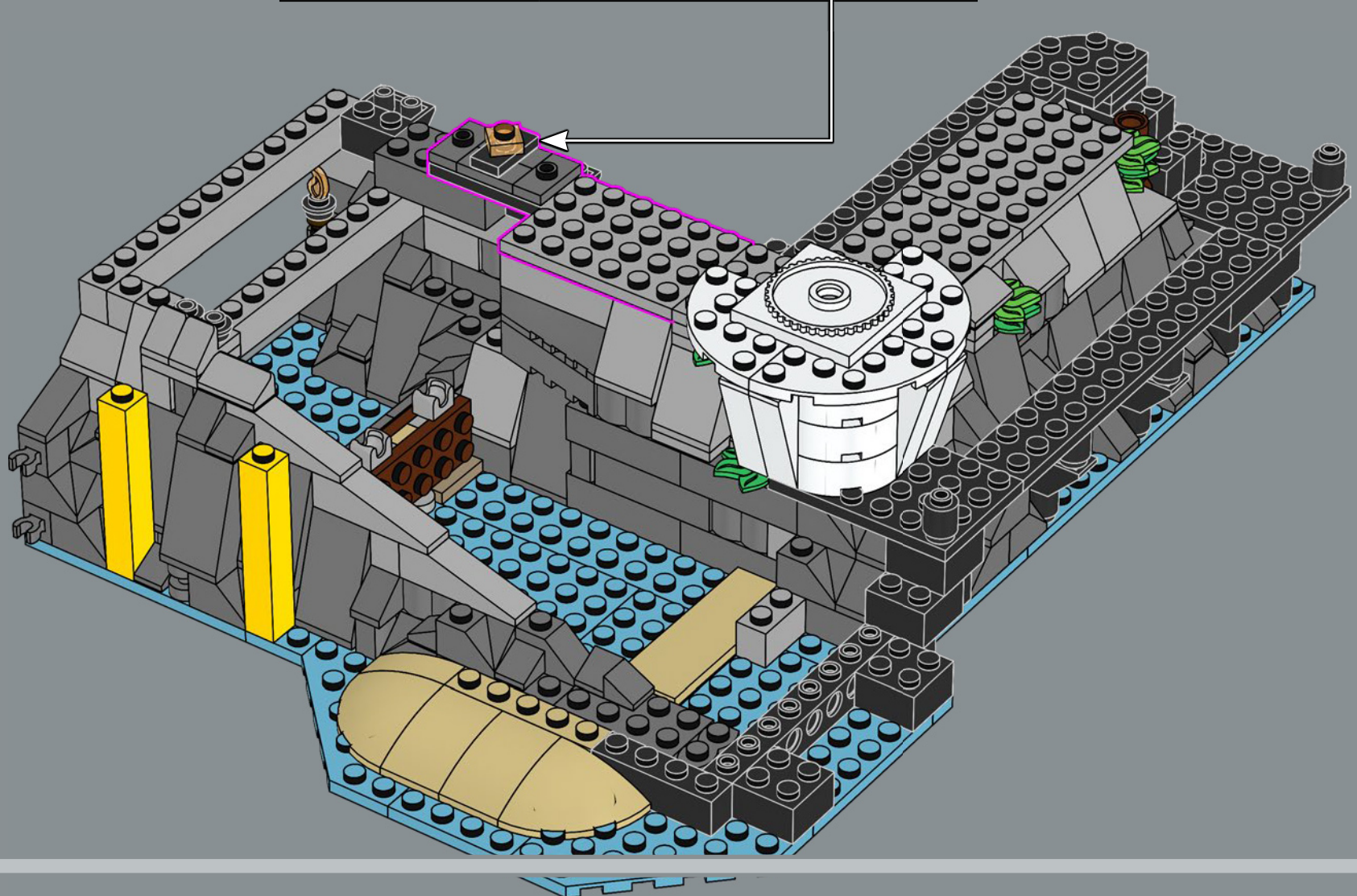

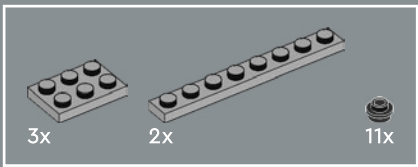

84

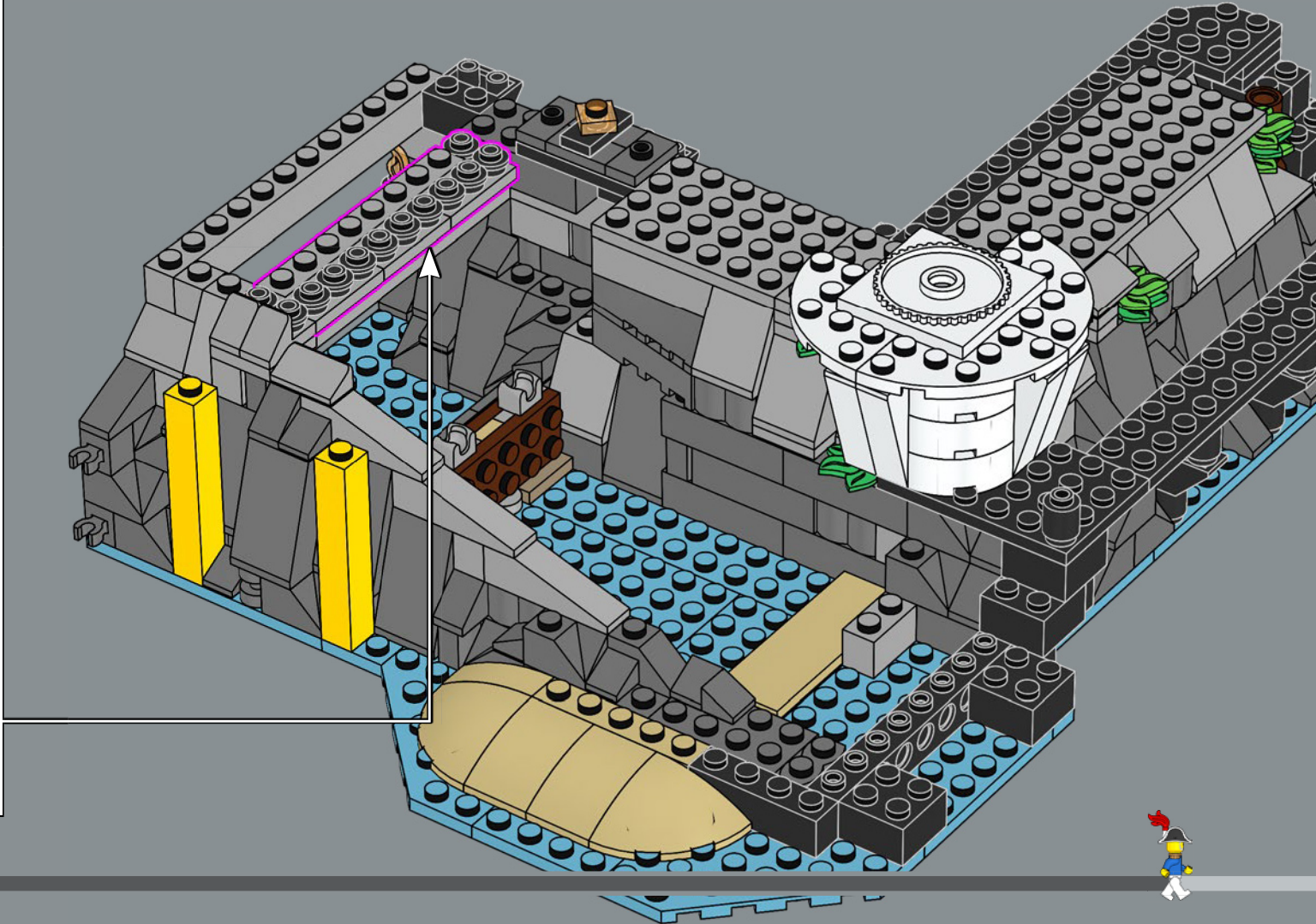
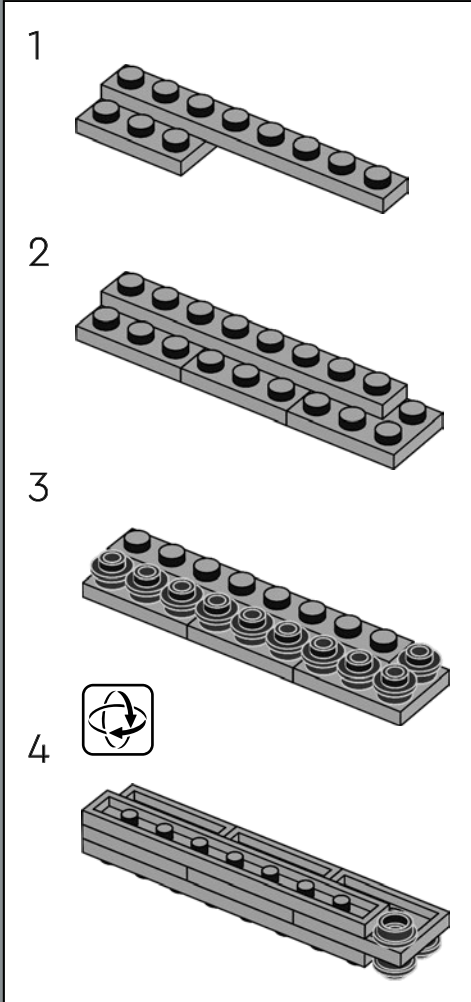

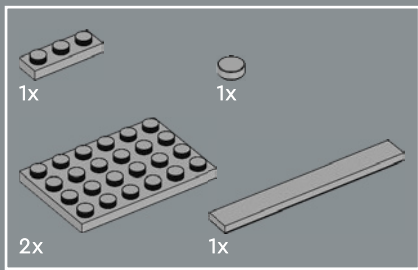

85

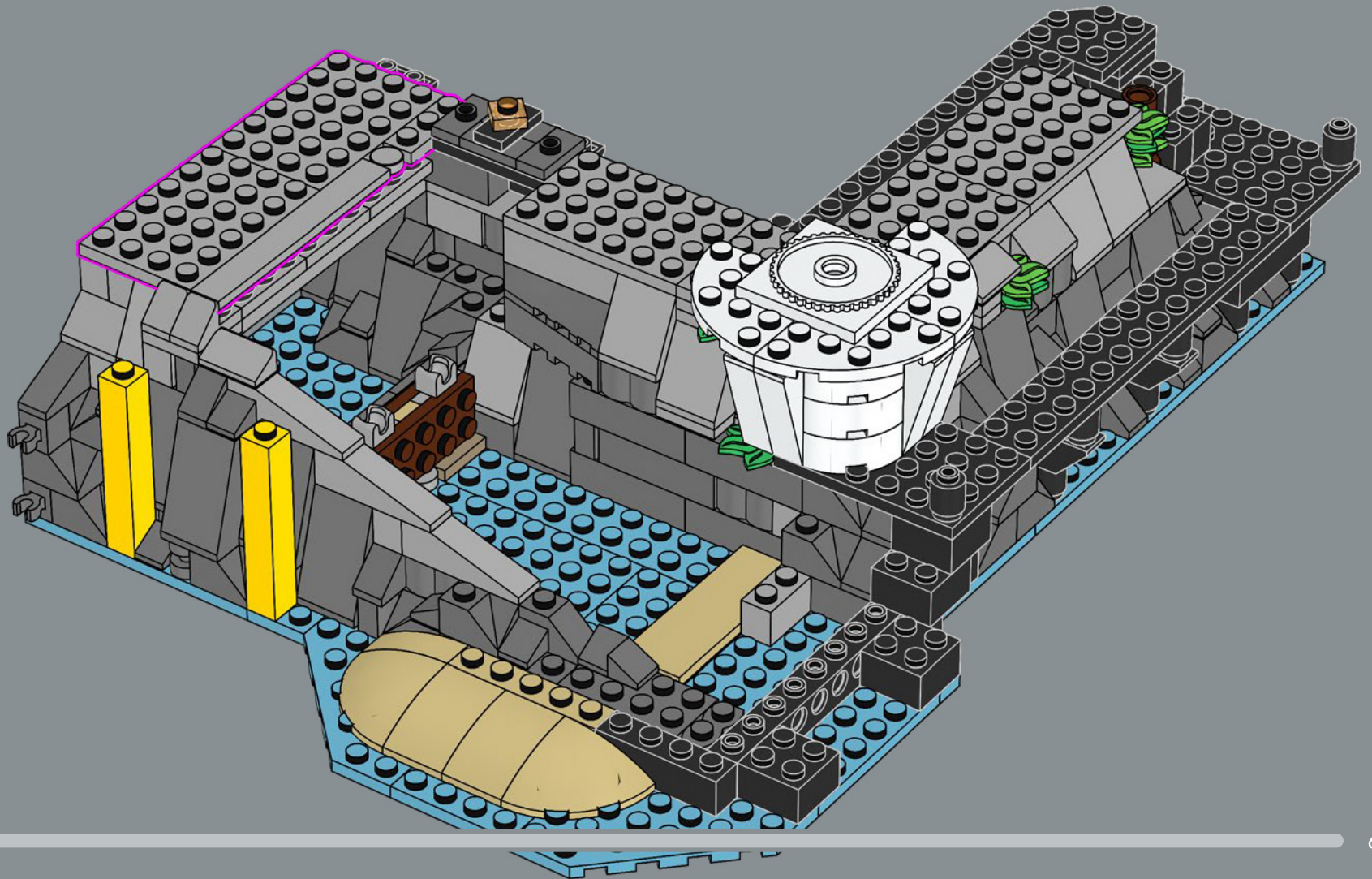

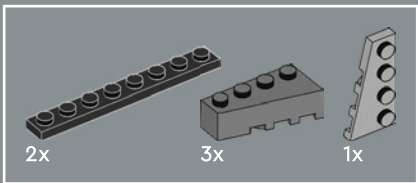

86

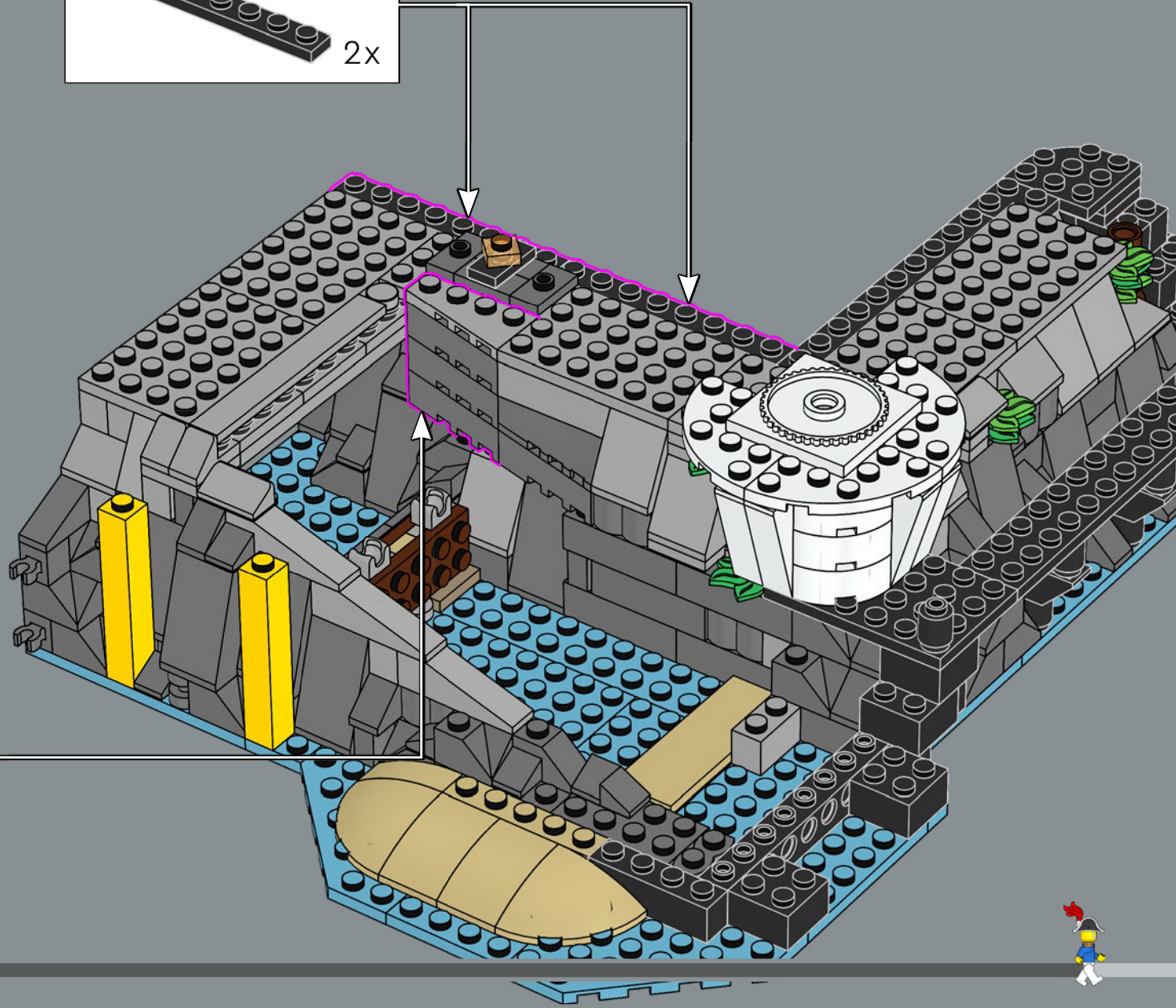
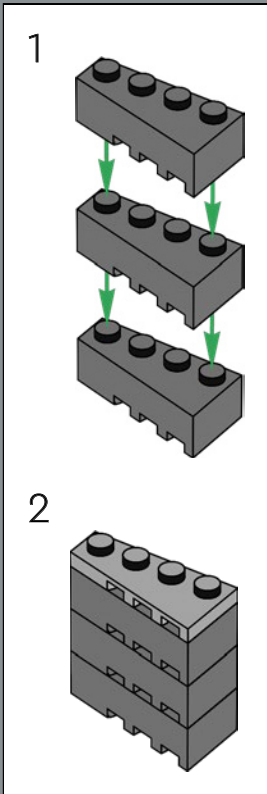
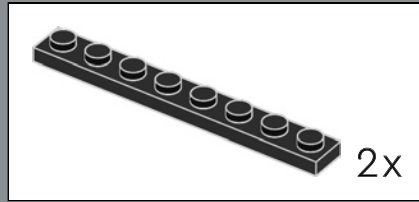

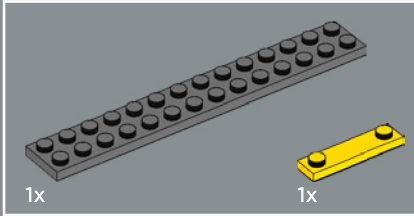
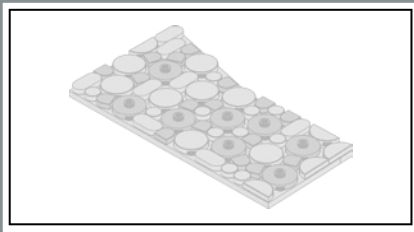

87

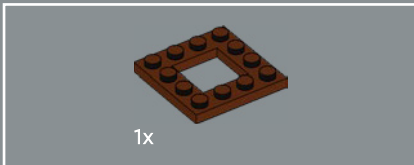
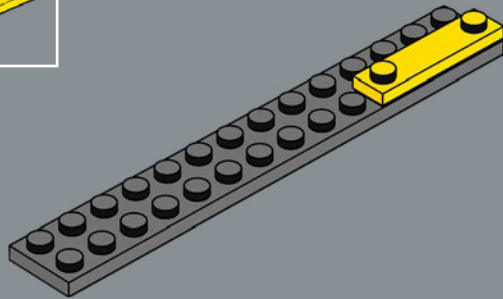

88

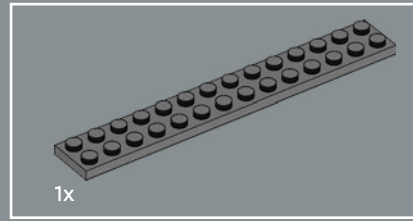
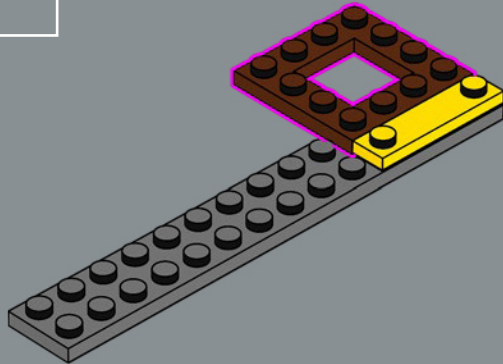

89

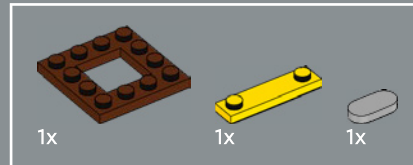
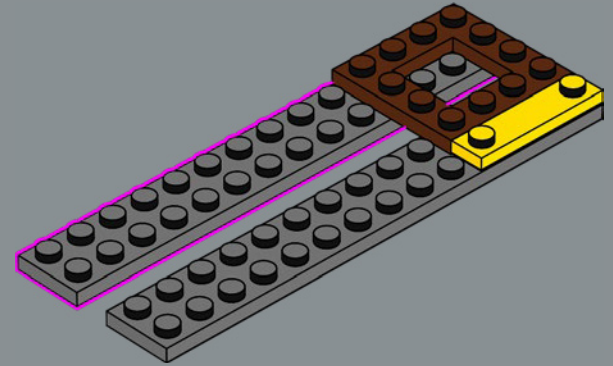

90

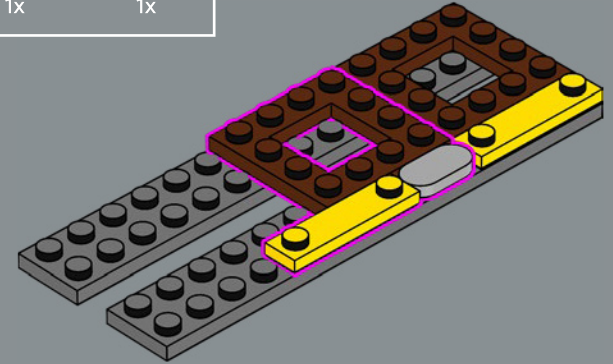

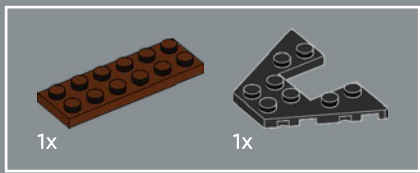

91

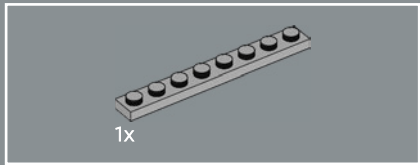
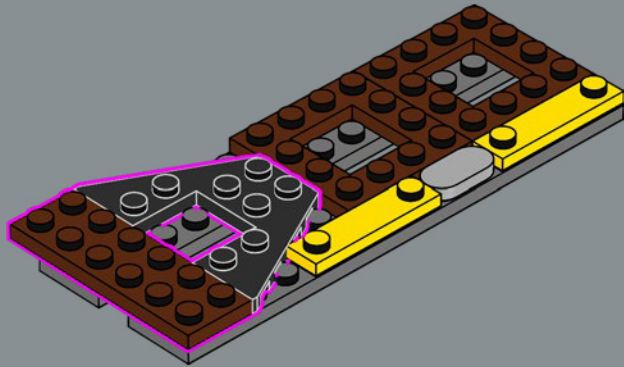

92

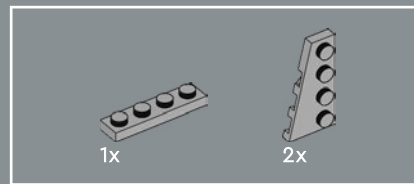
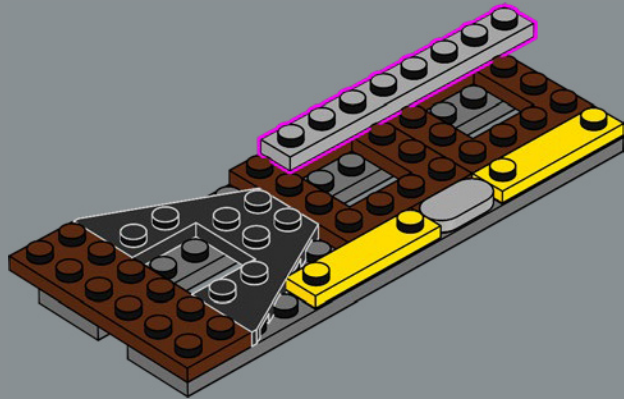

93

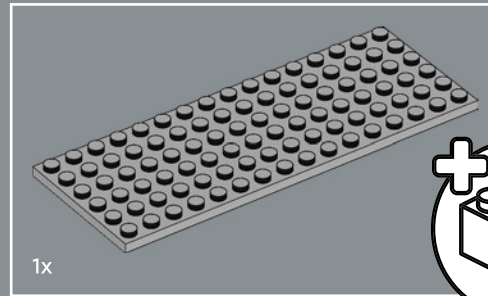
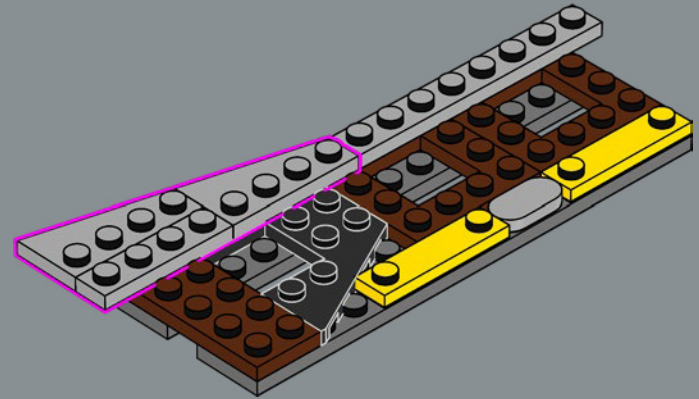

94

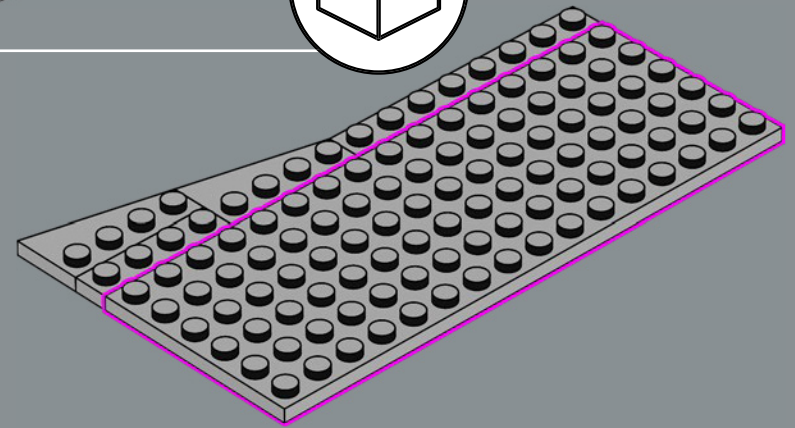

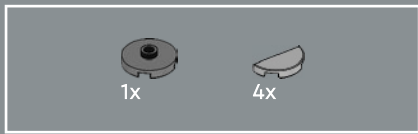

95

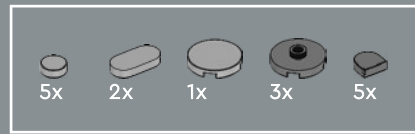
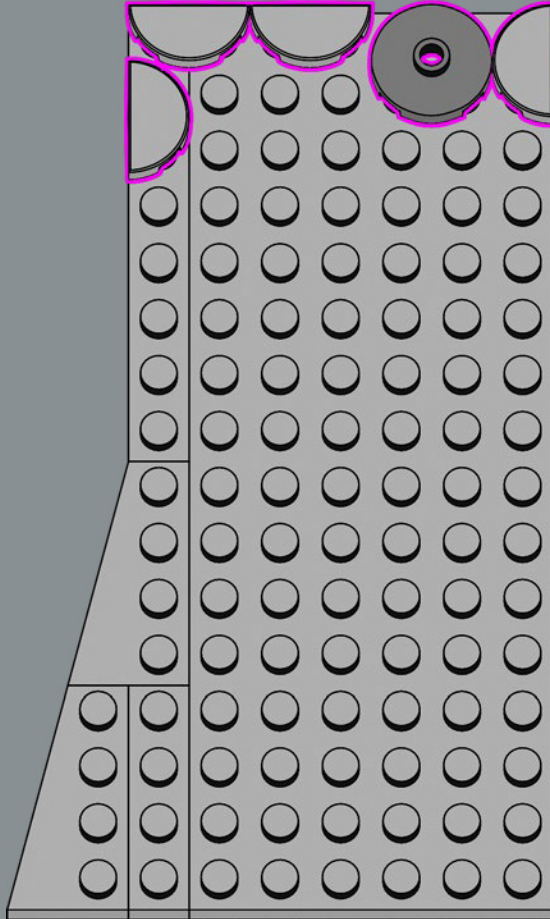

96

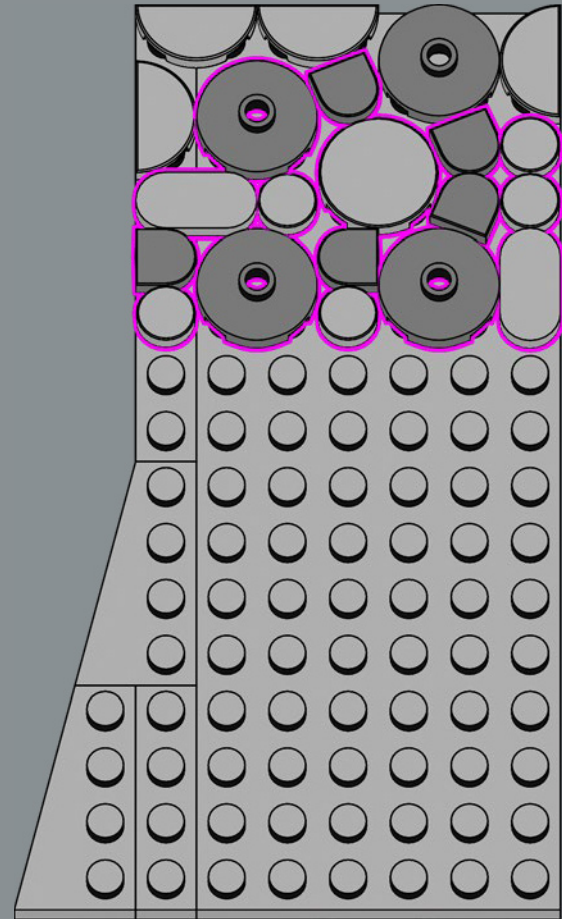

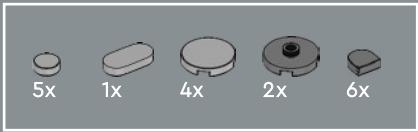

97

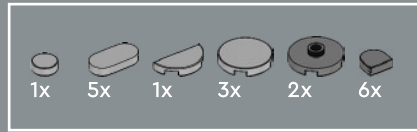
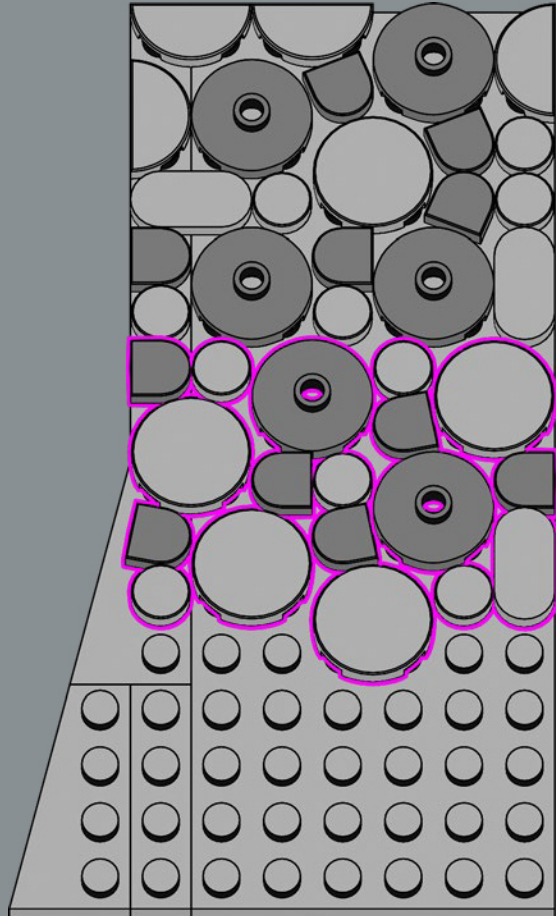

98

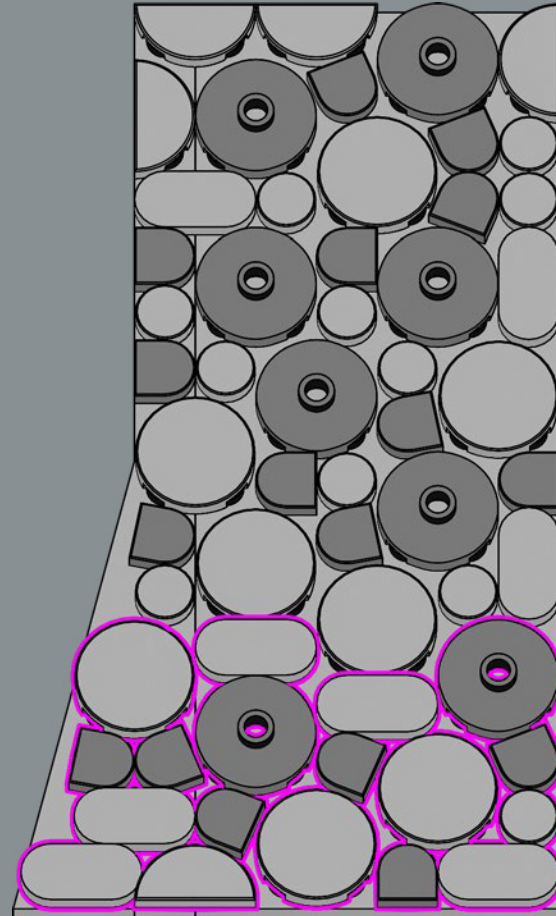

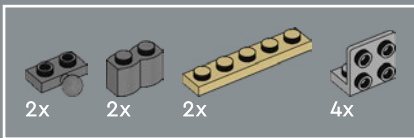

99

1

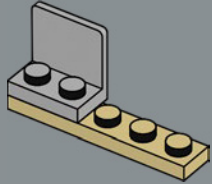

2

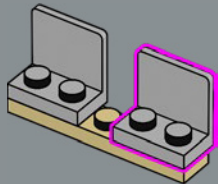

3

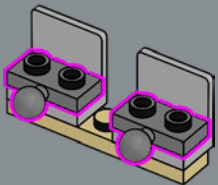

4

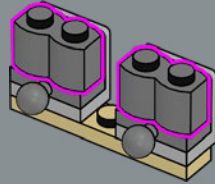

5

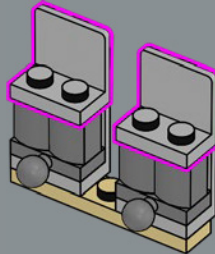

6

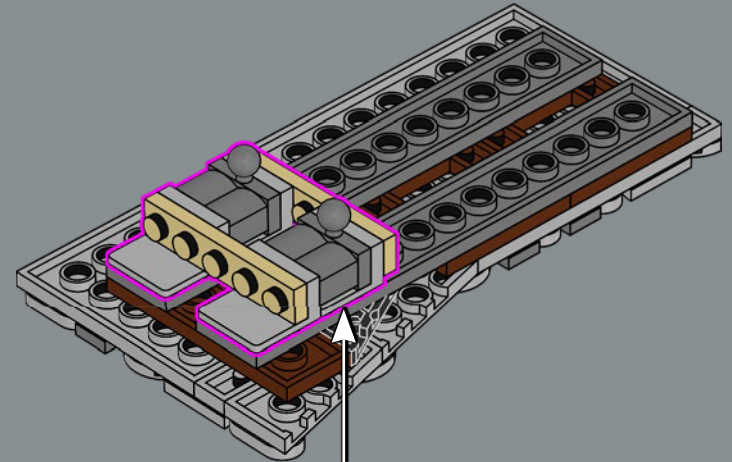
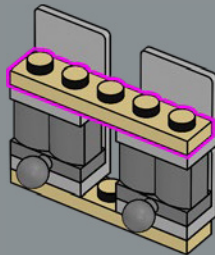



La rampa originale stampata è stata
ripavimentata con sampietrini.

100

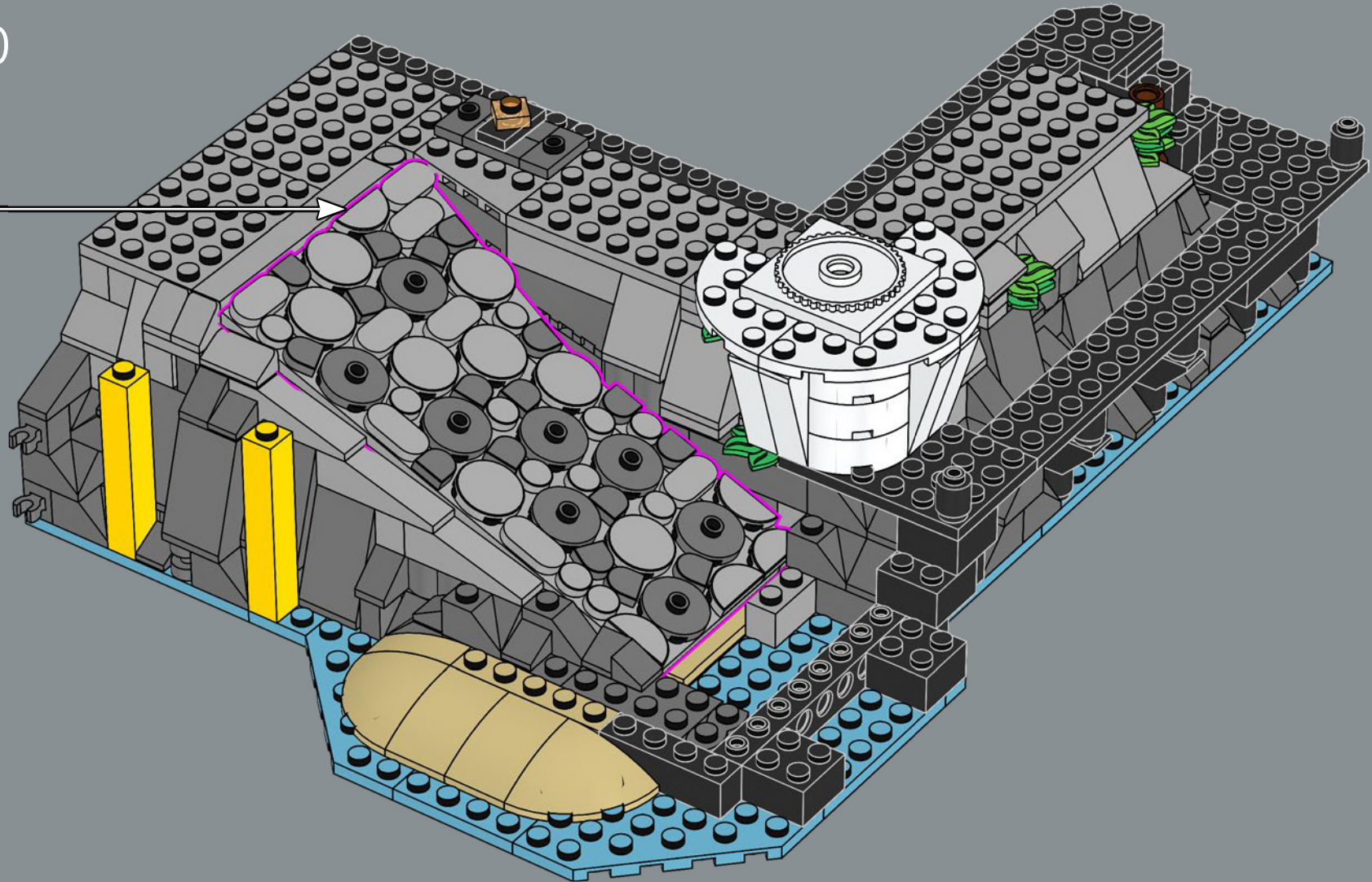
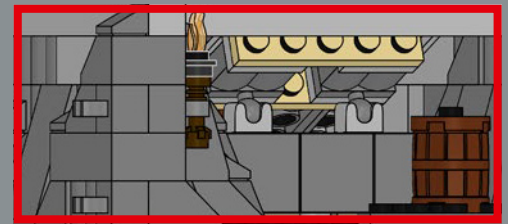

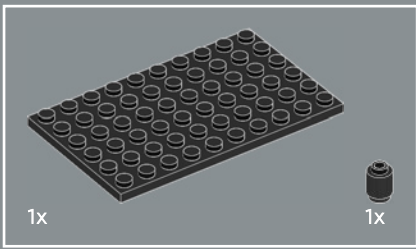

101

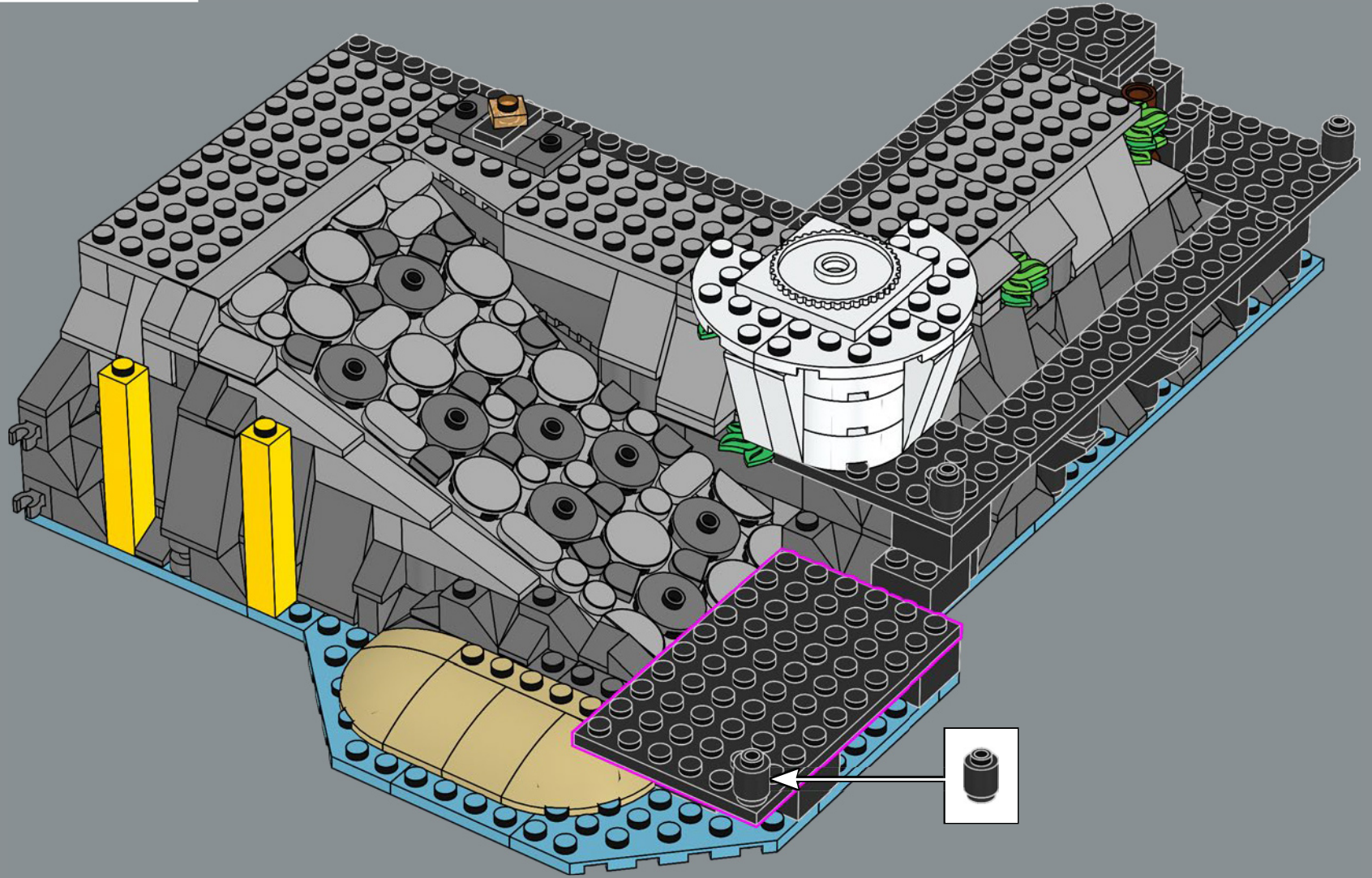

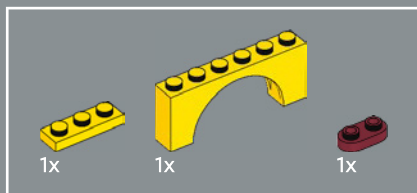

102

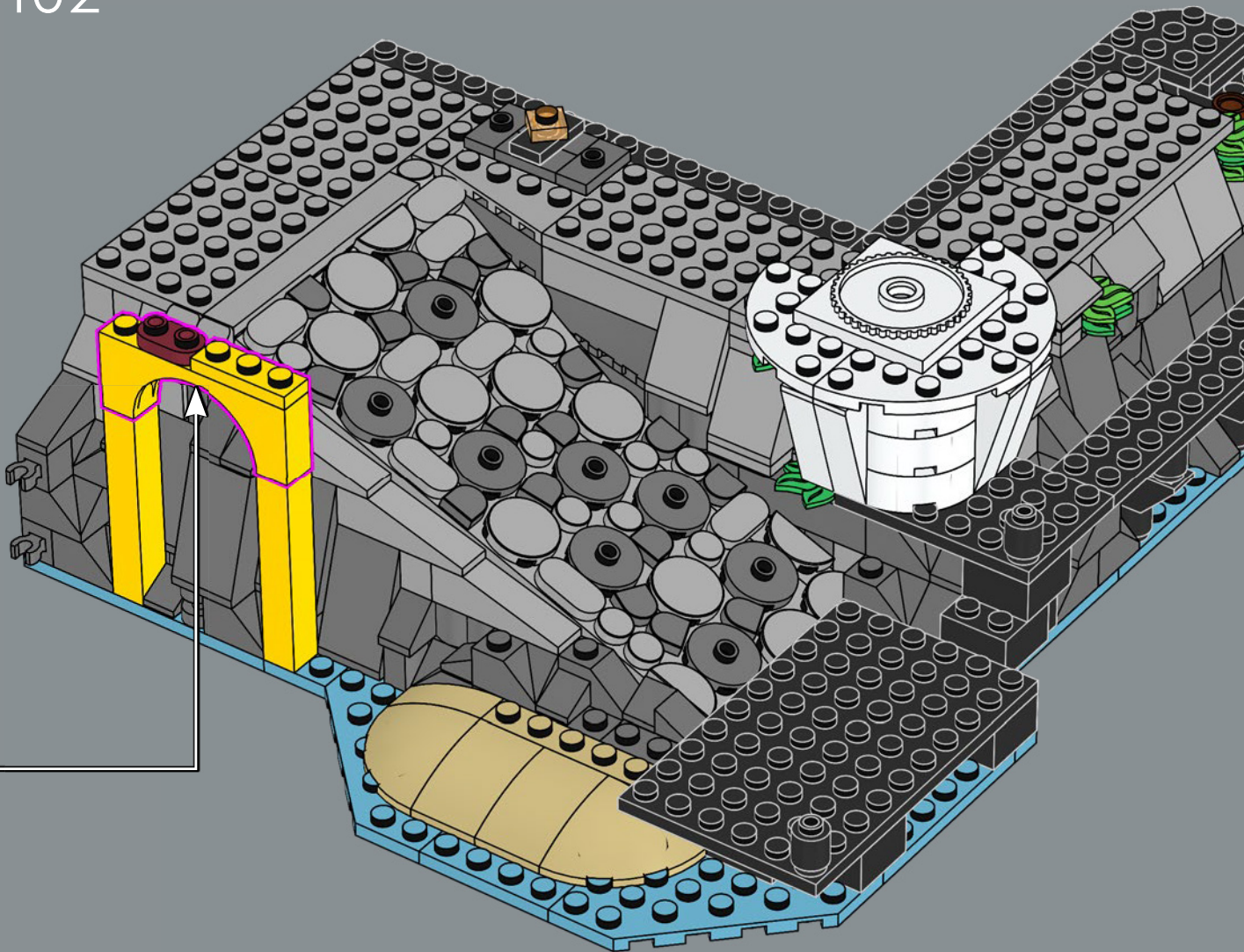
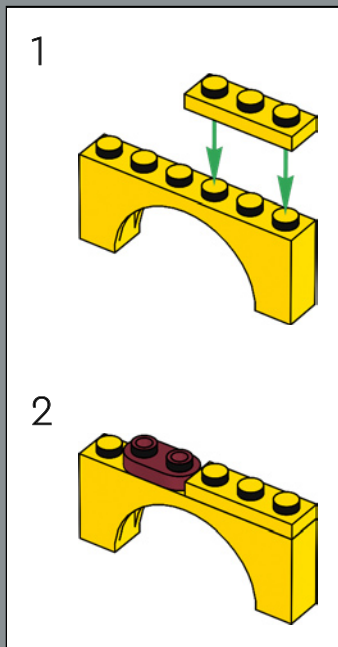

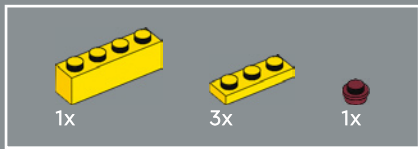

103

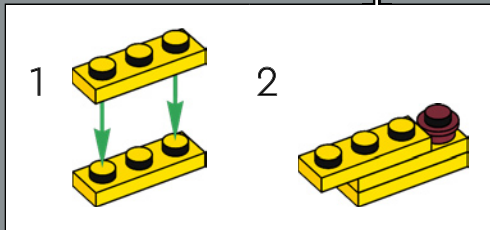
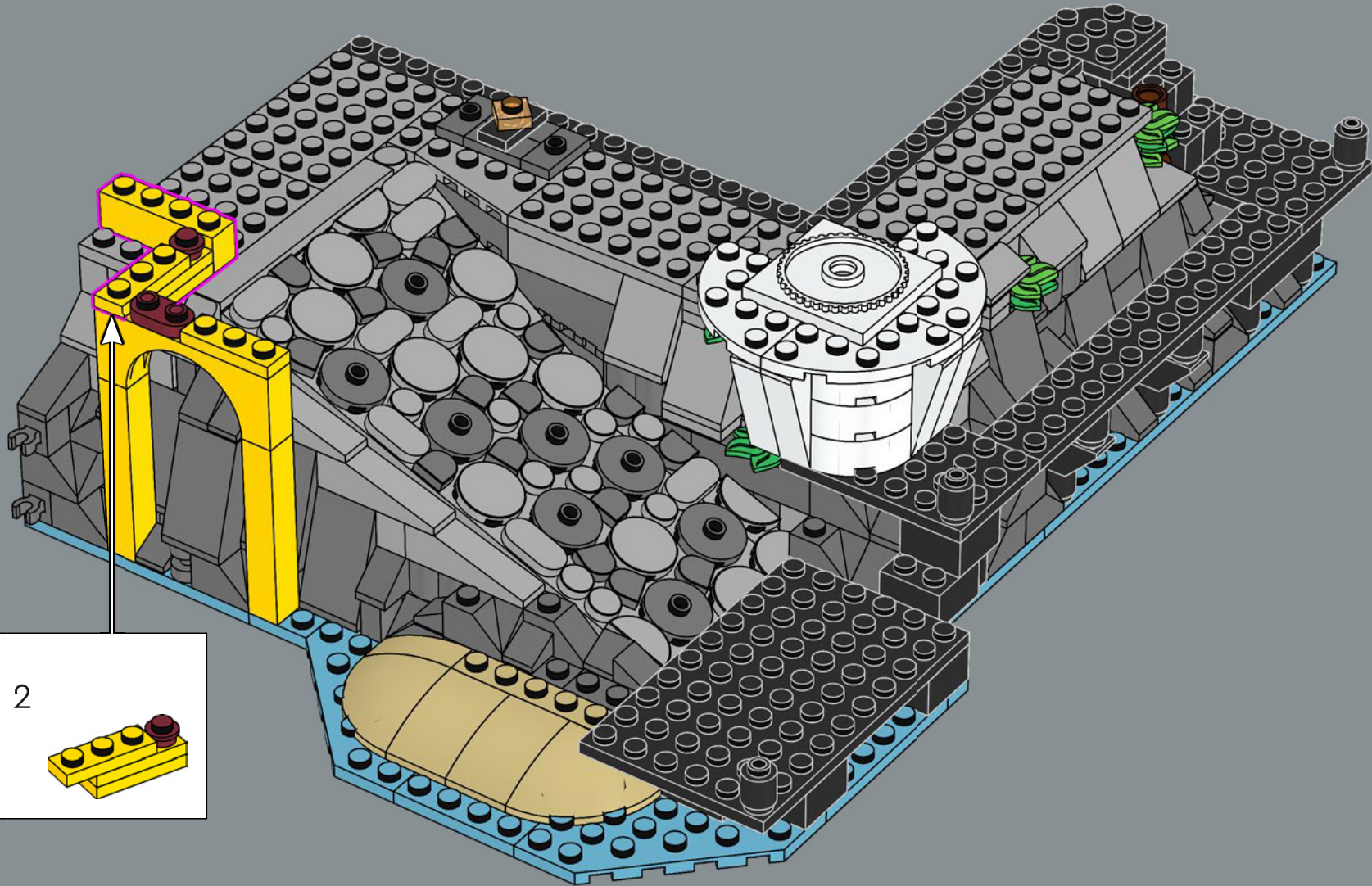

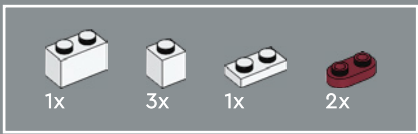

104

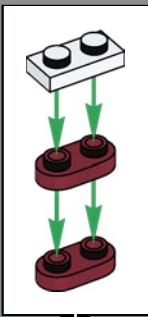

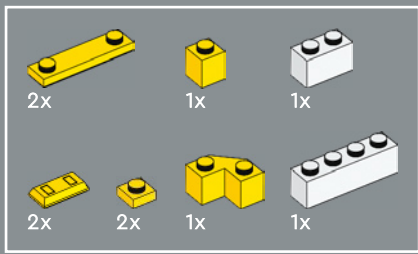

105



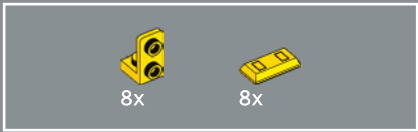

106

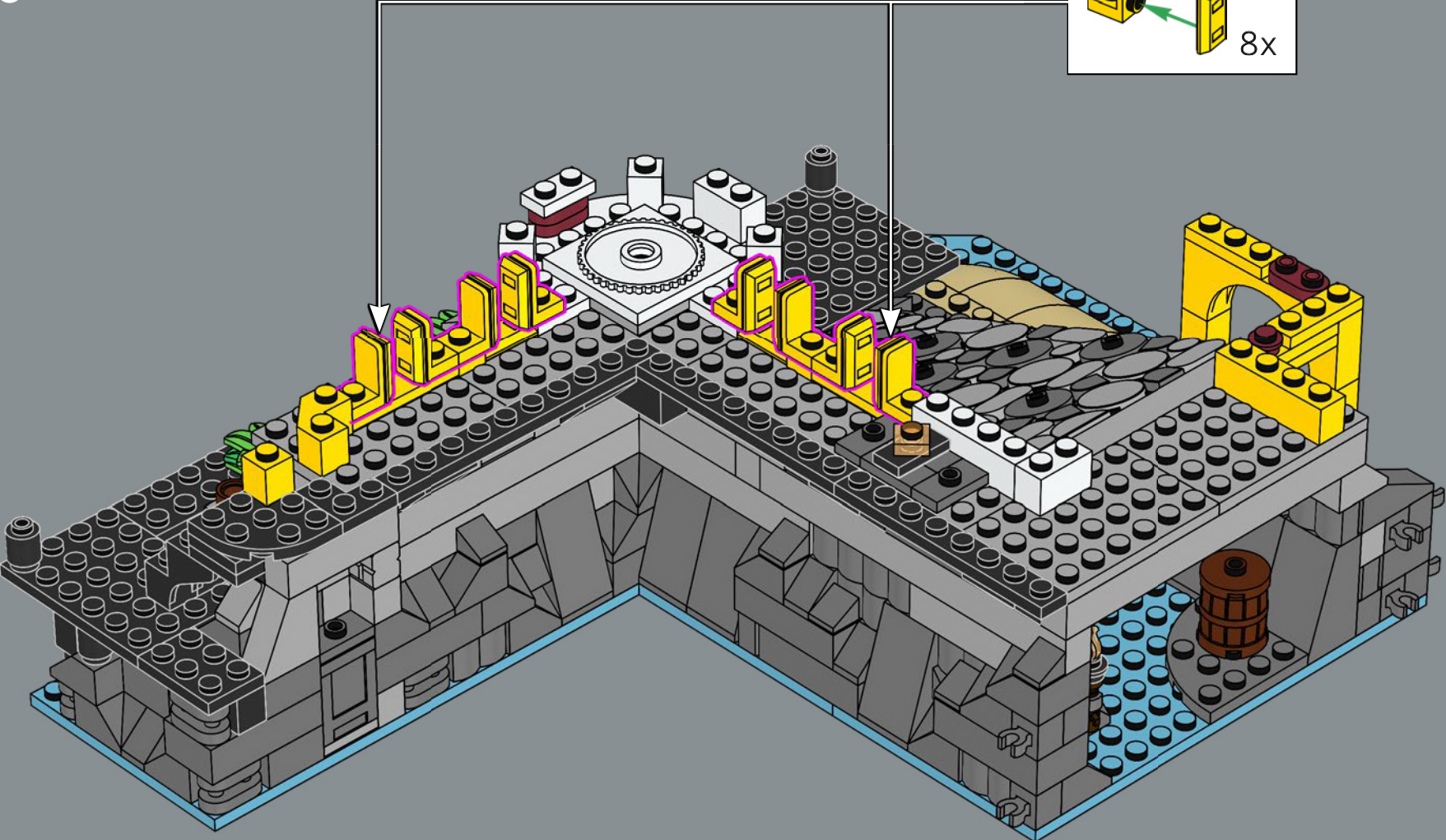
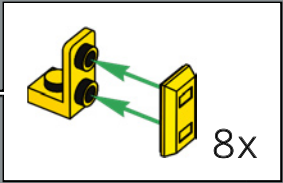

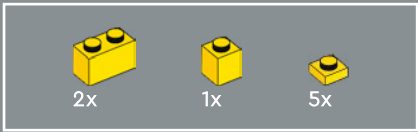

107

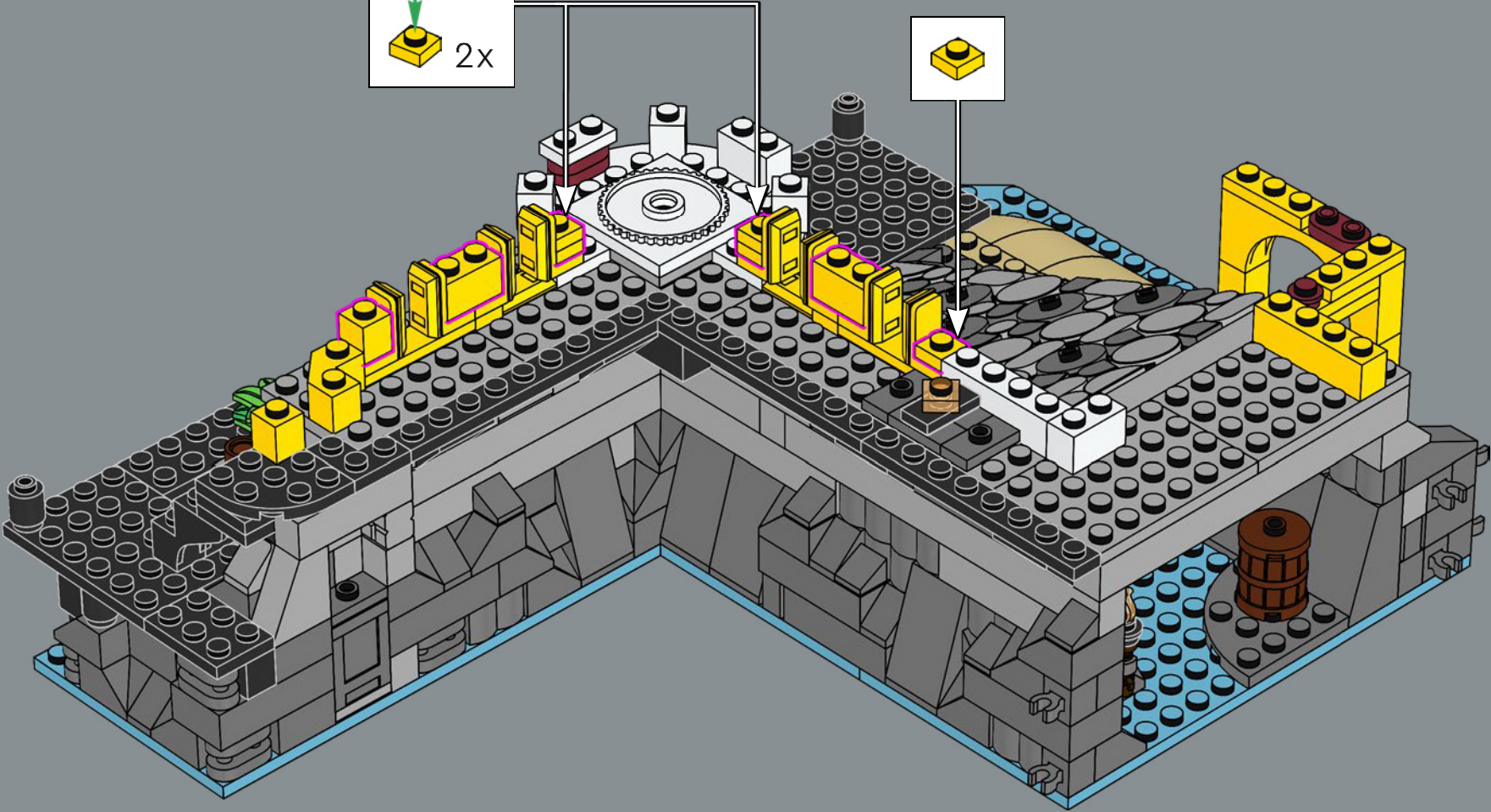
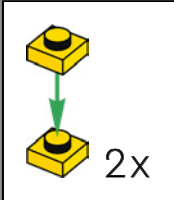

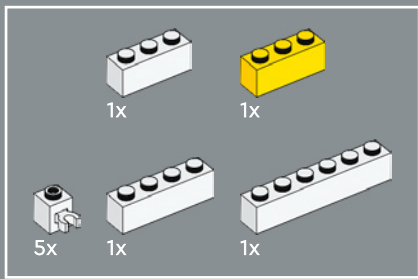

109

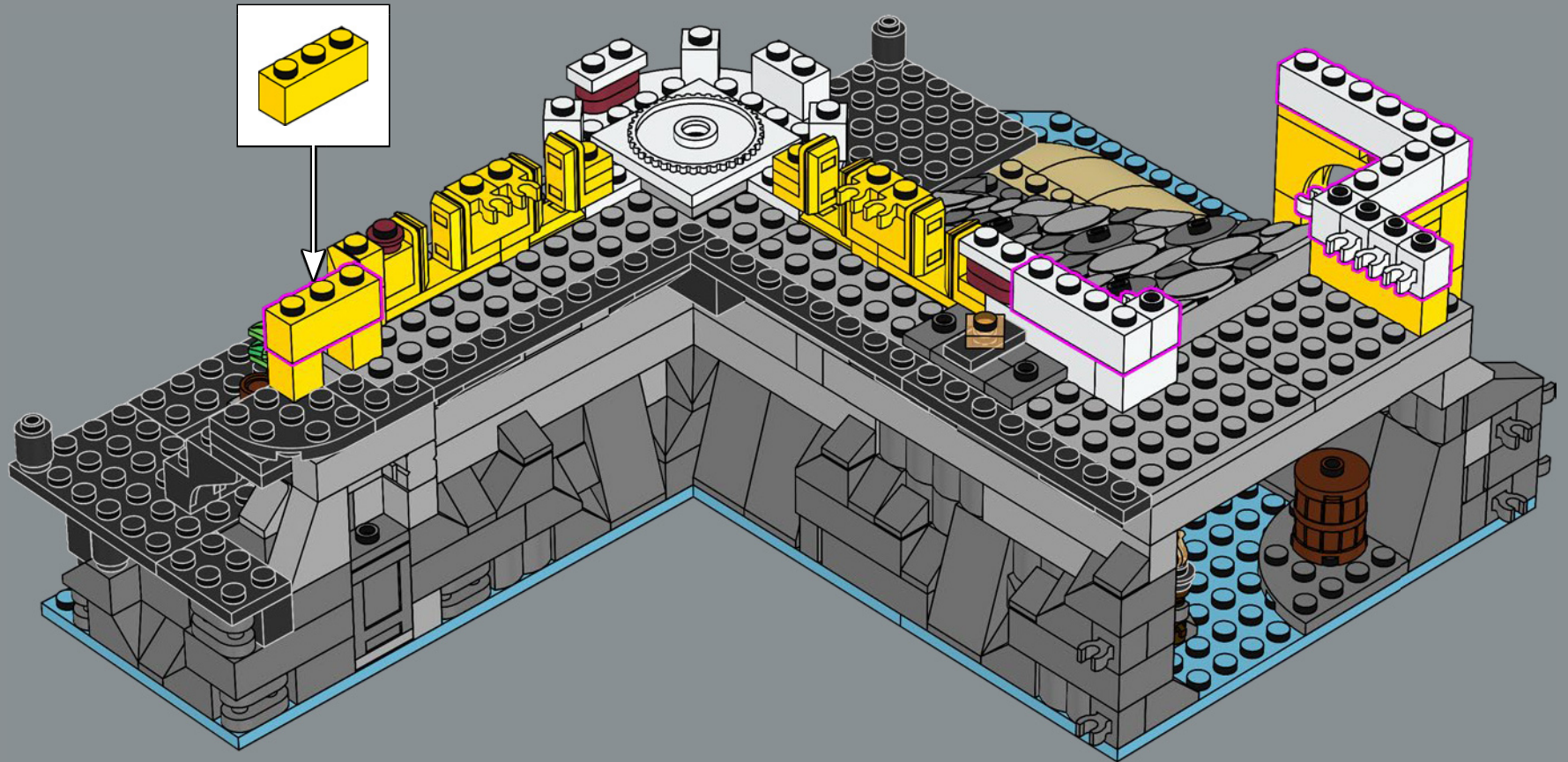

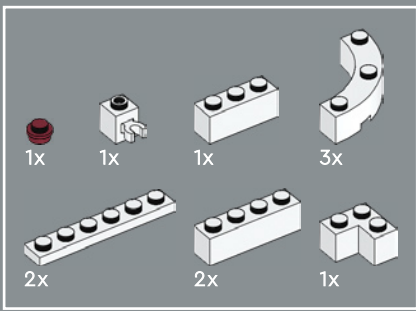

110

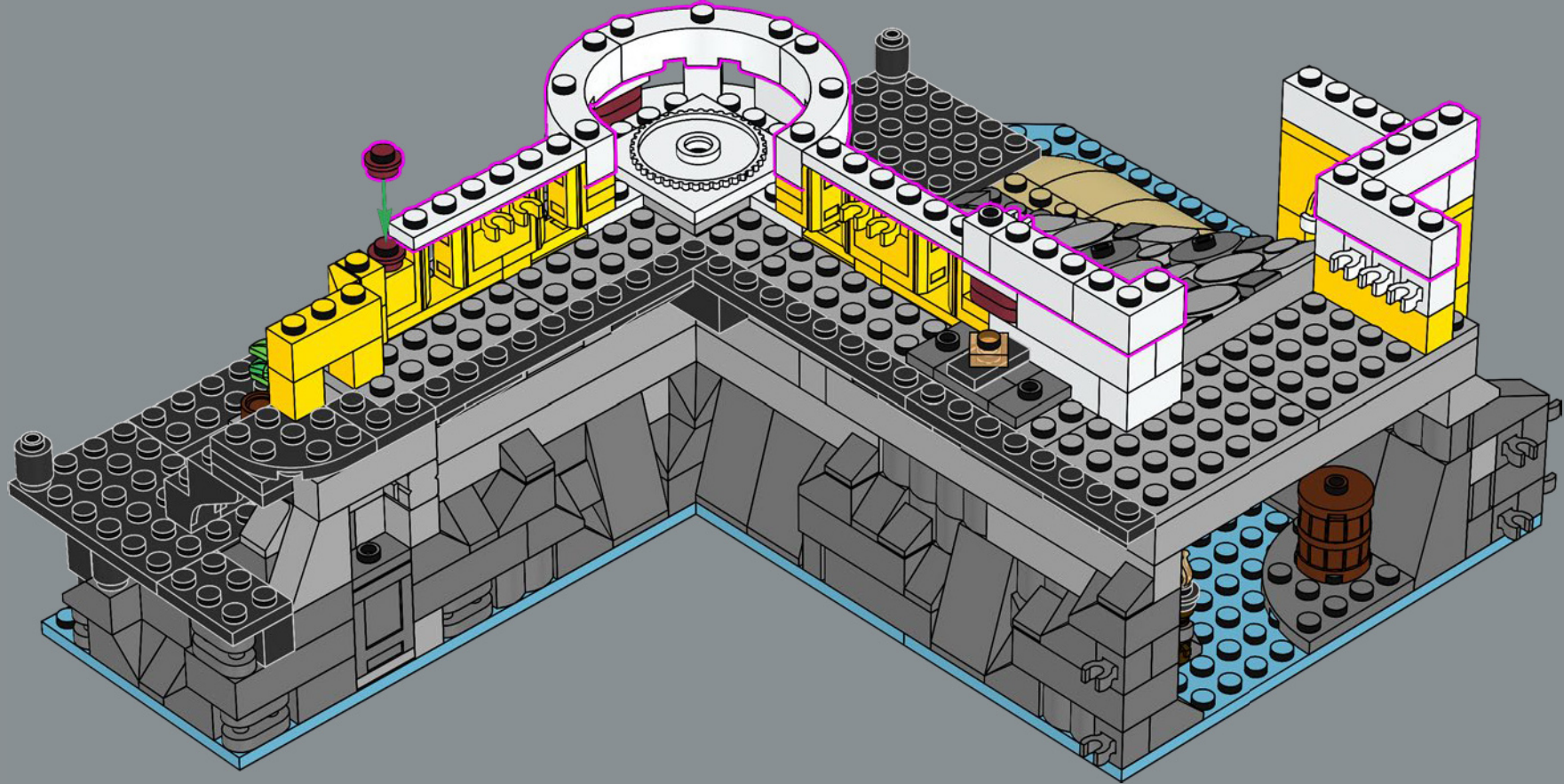

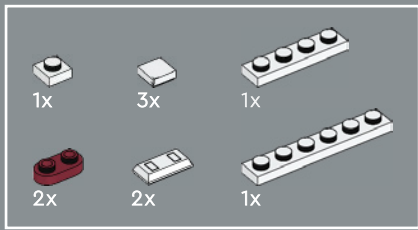

111

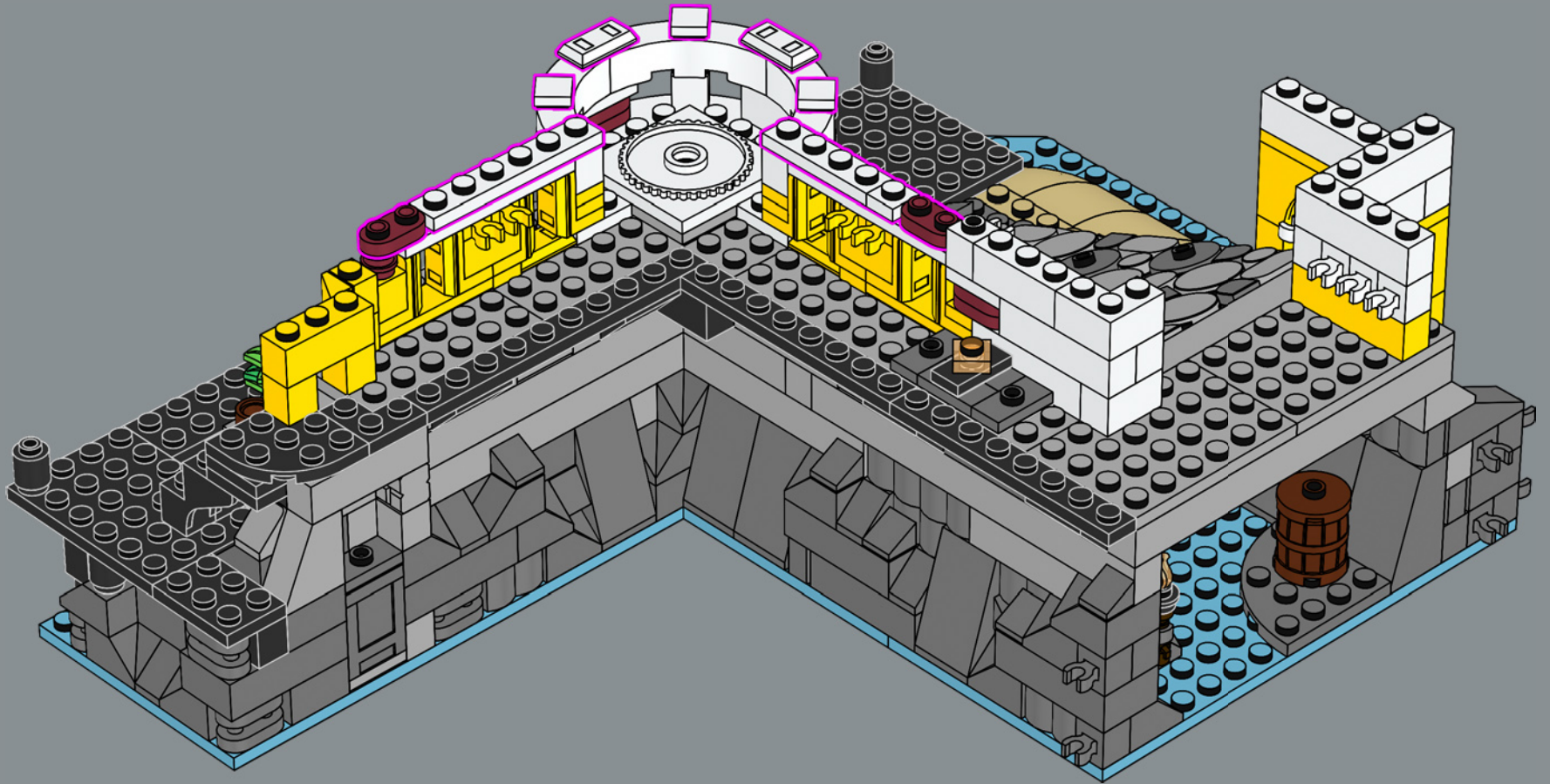

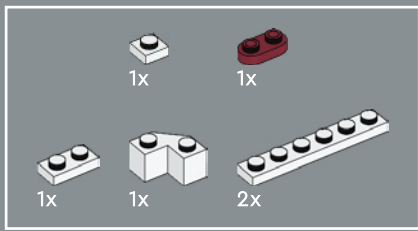

112

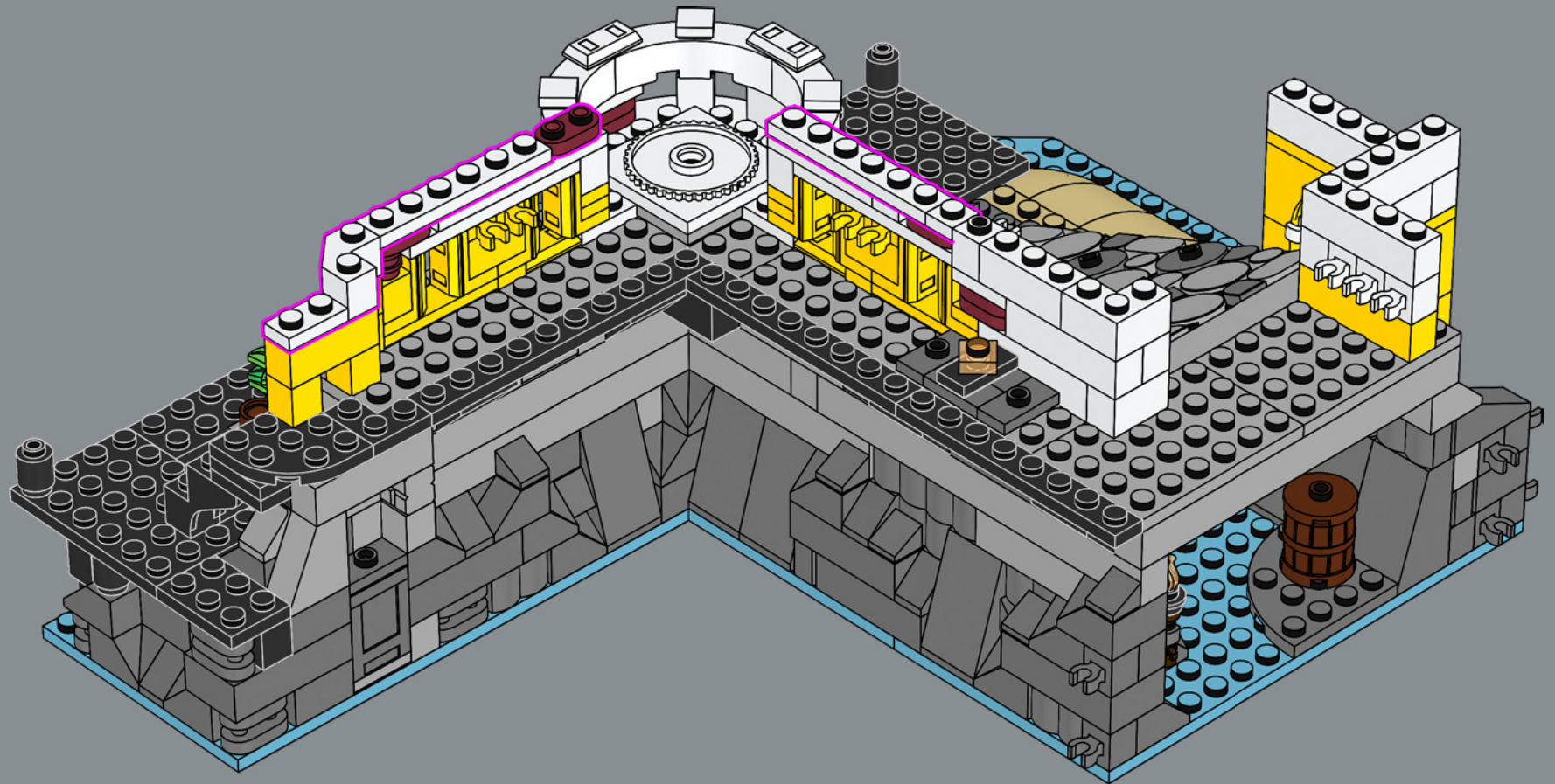

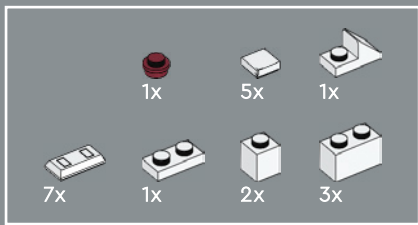

113

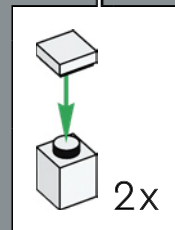
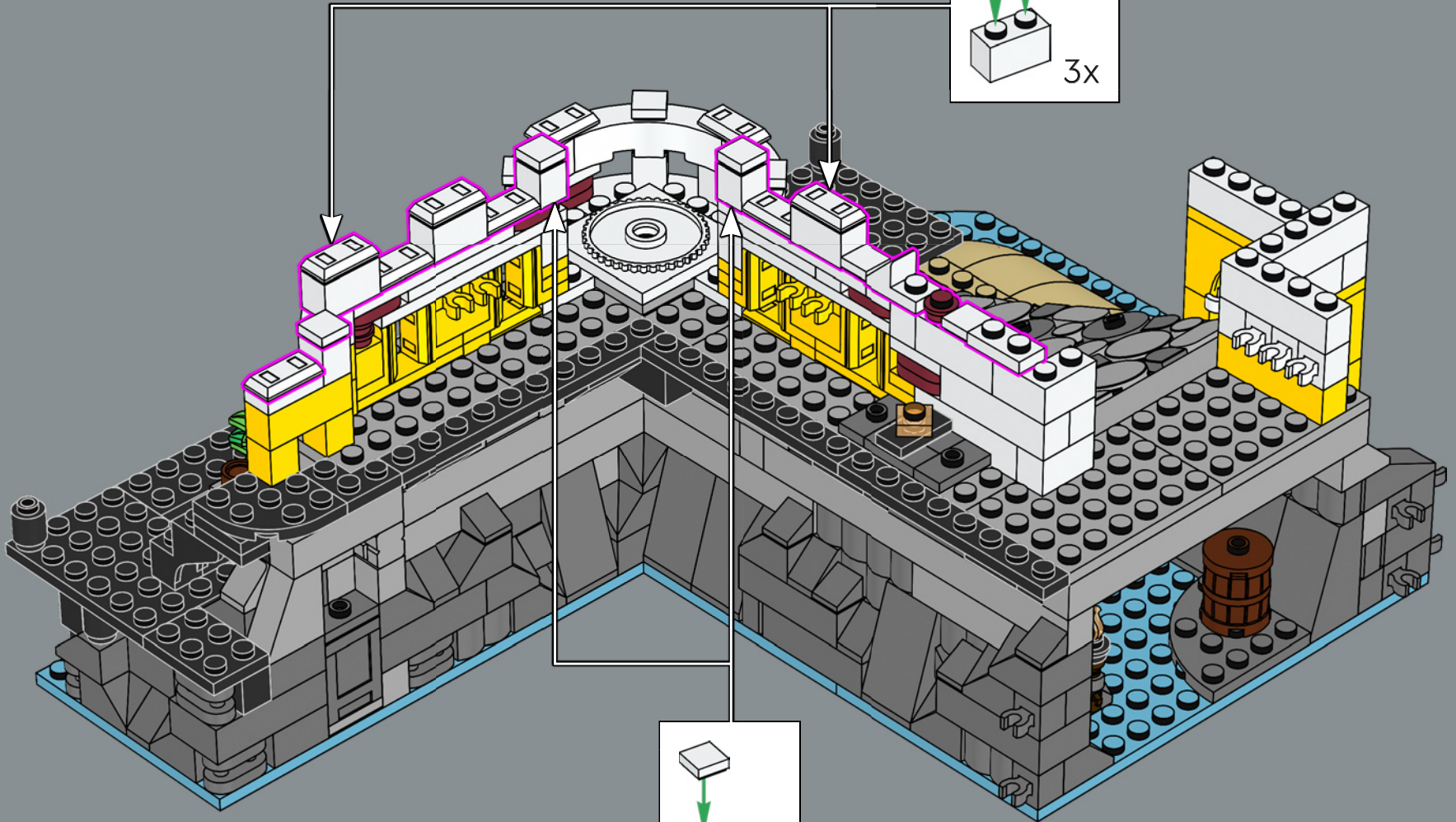
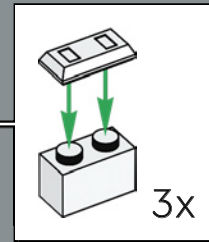

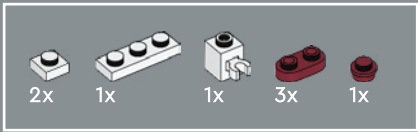

114

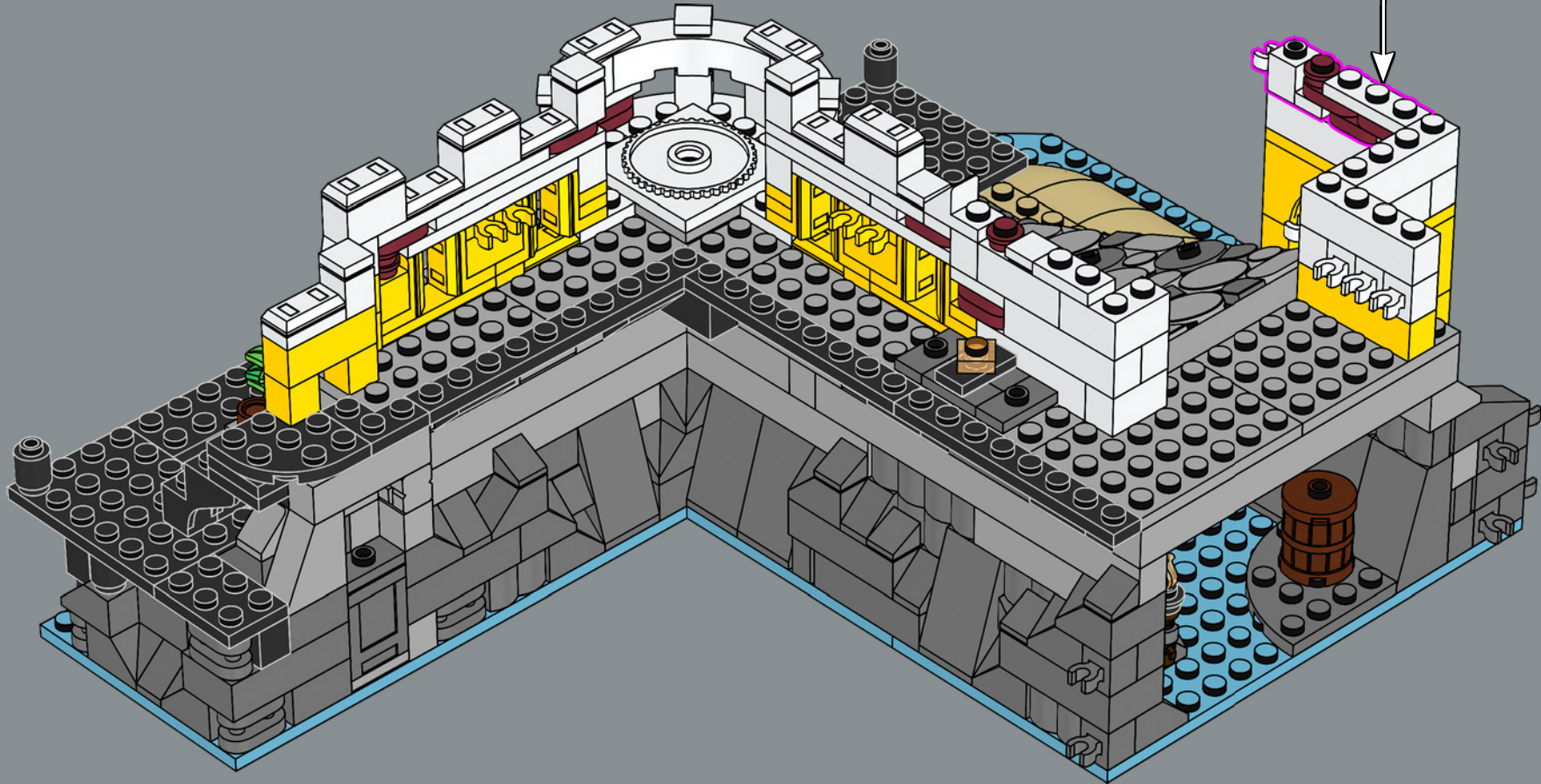
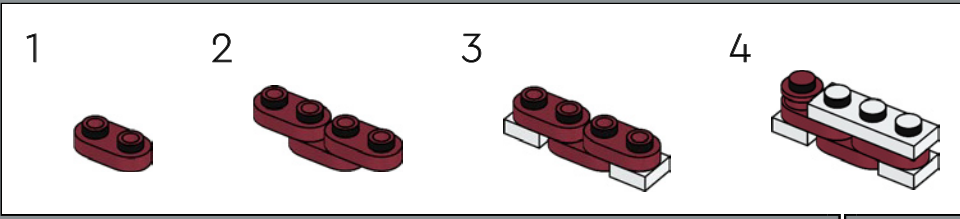

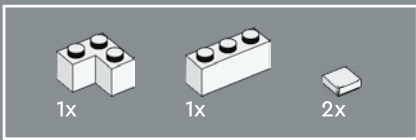

115

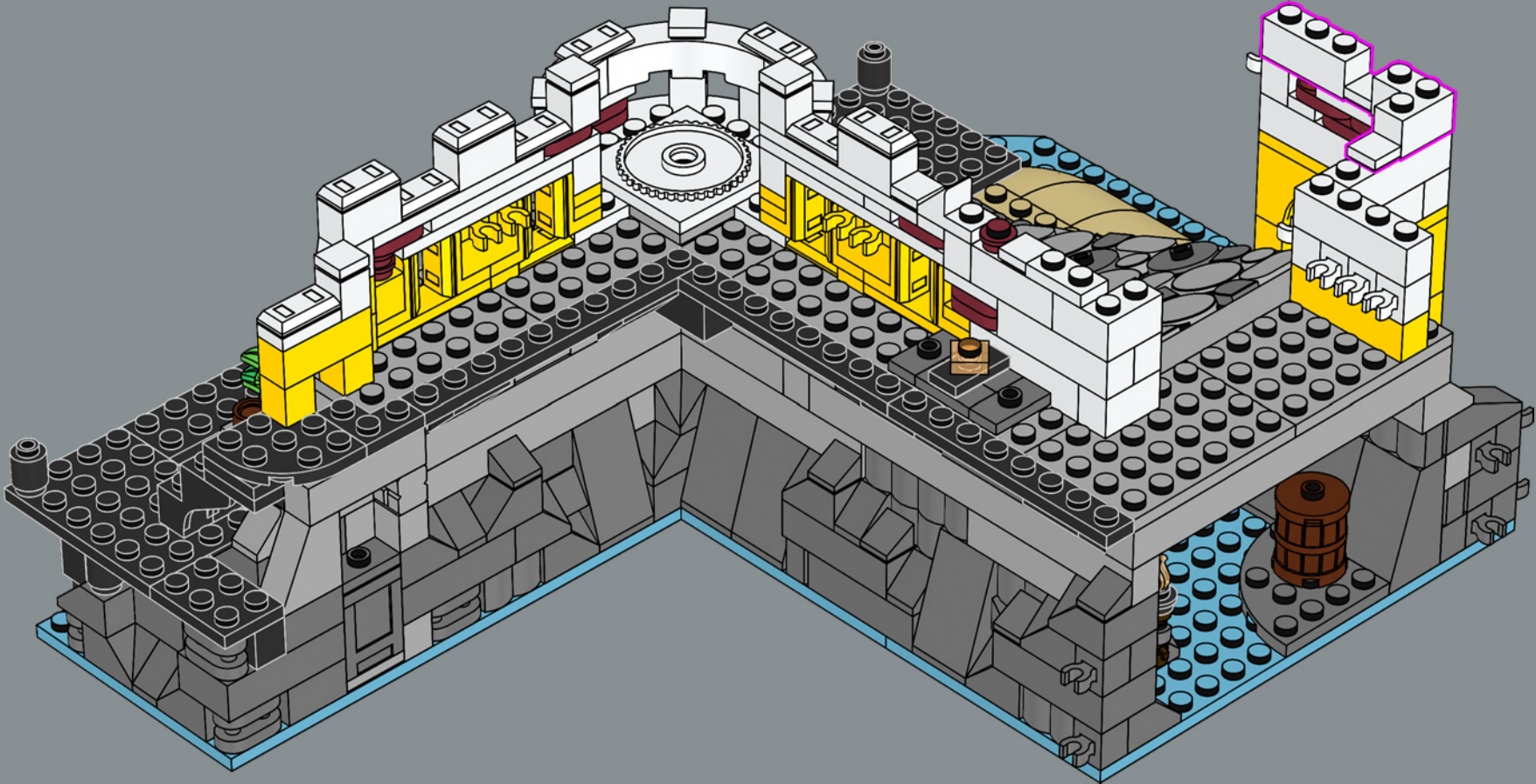

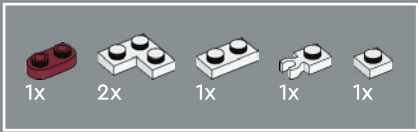

116

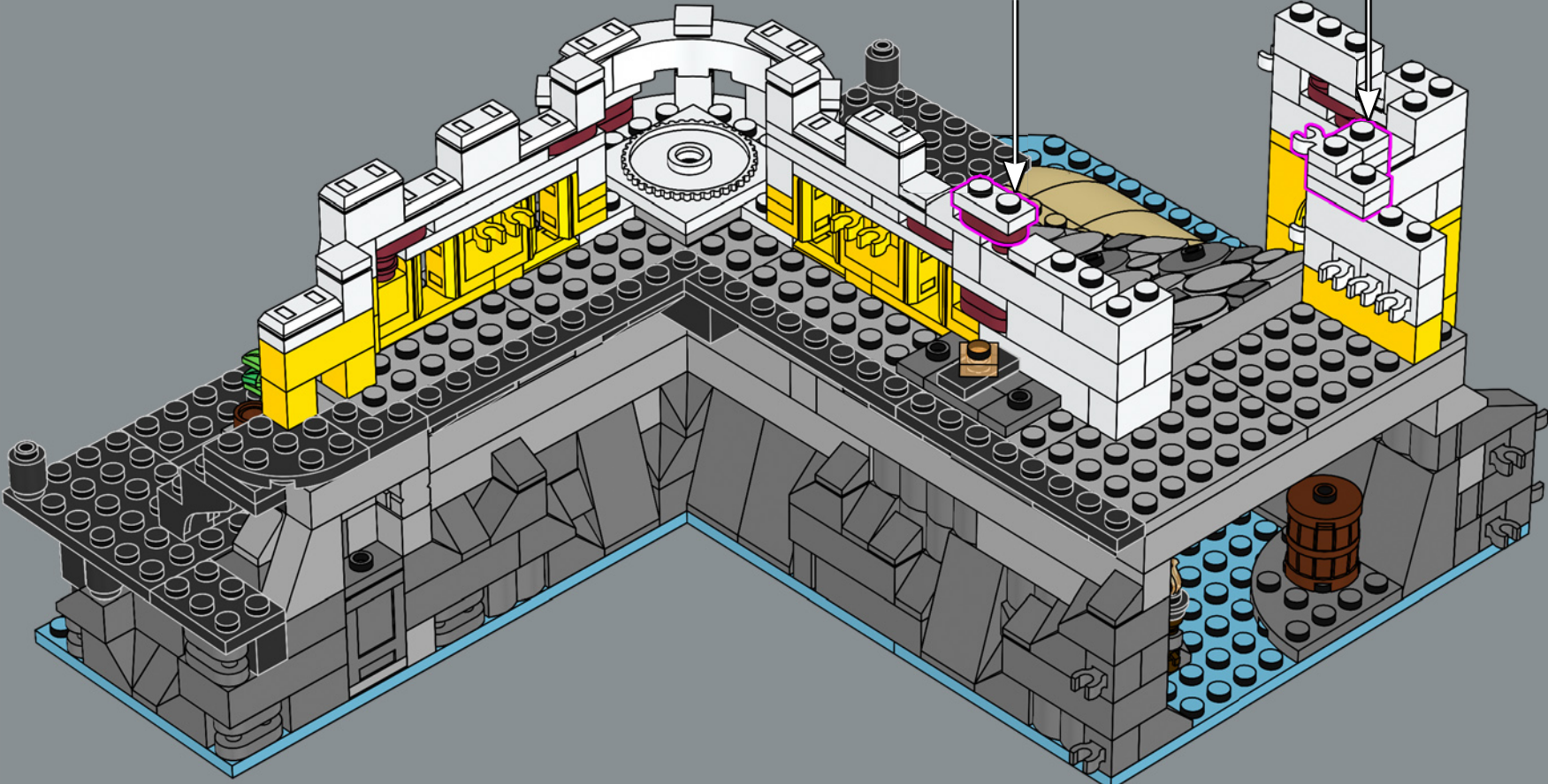
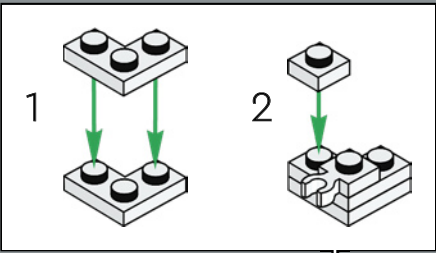
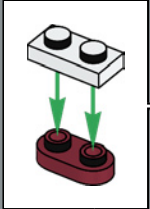



117

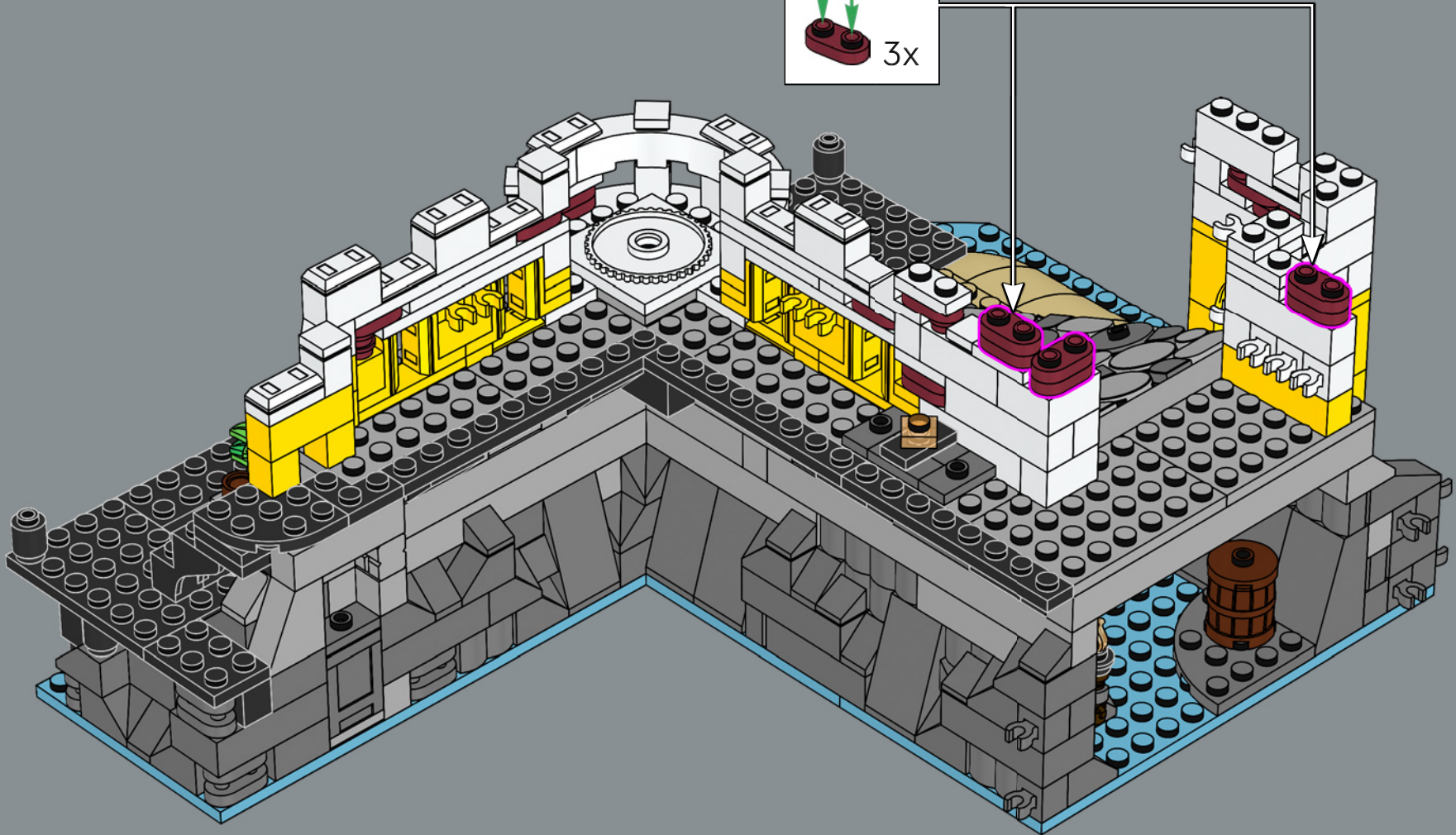
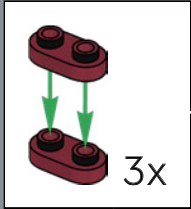

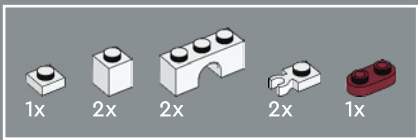

118

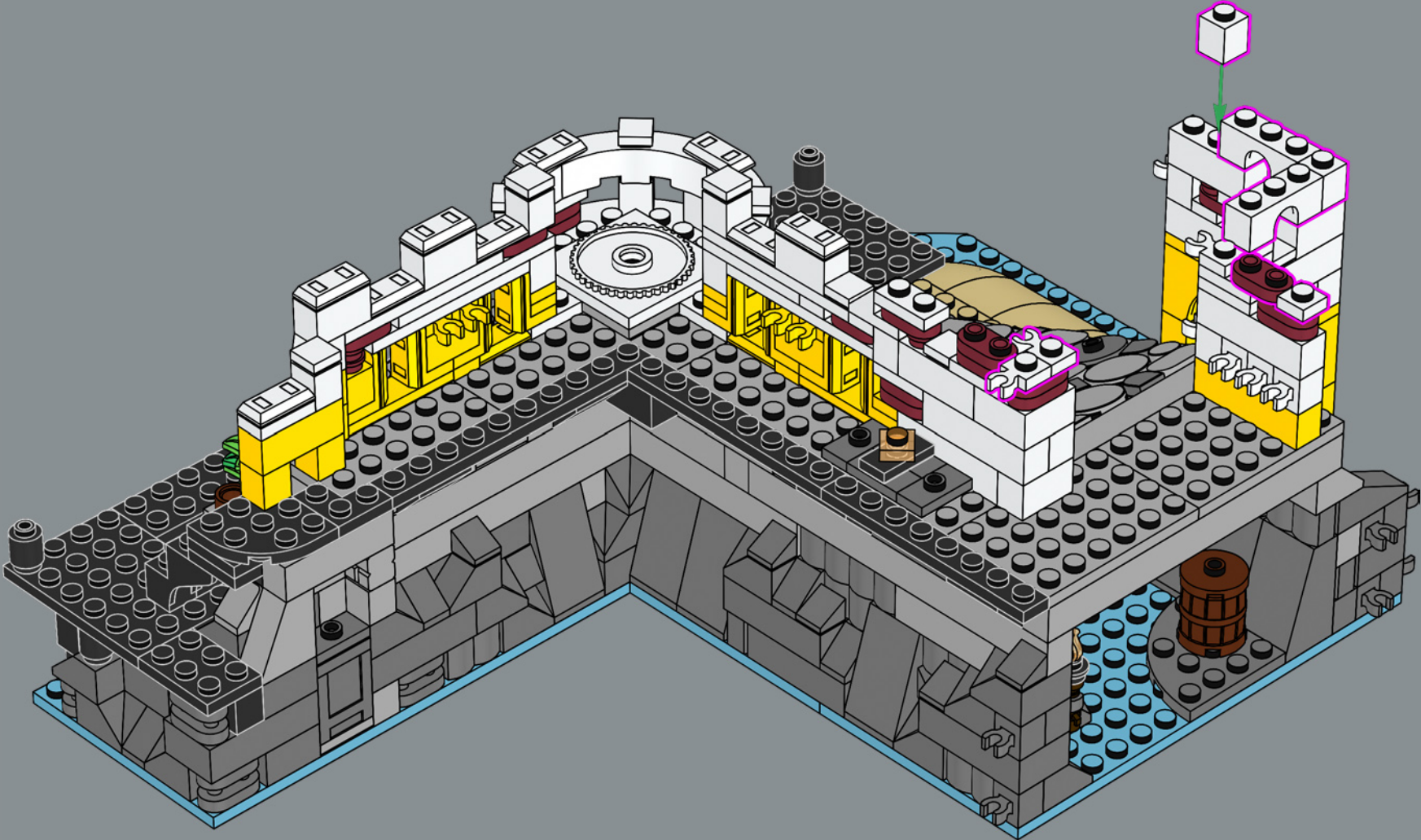

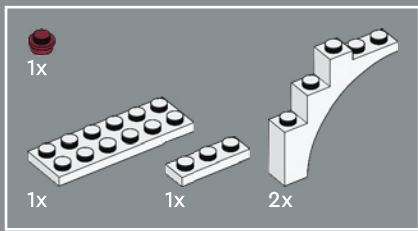

119

1

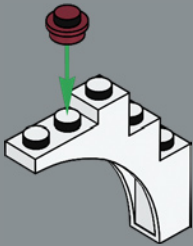

2

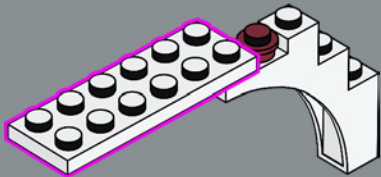

3

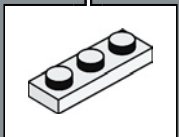
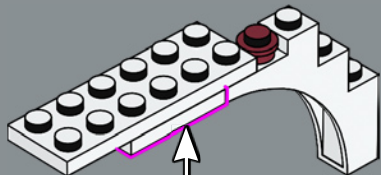

4

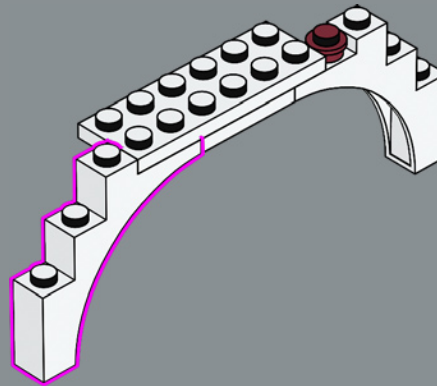

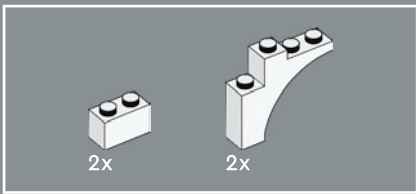

121

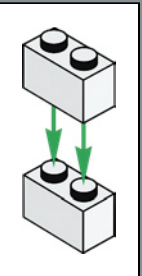
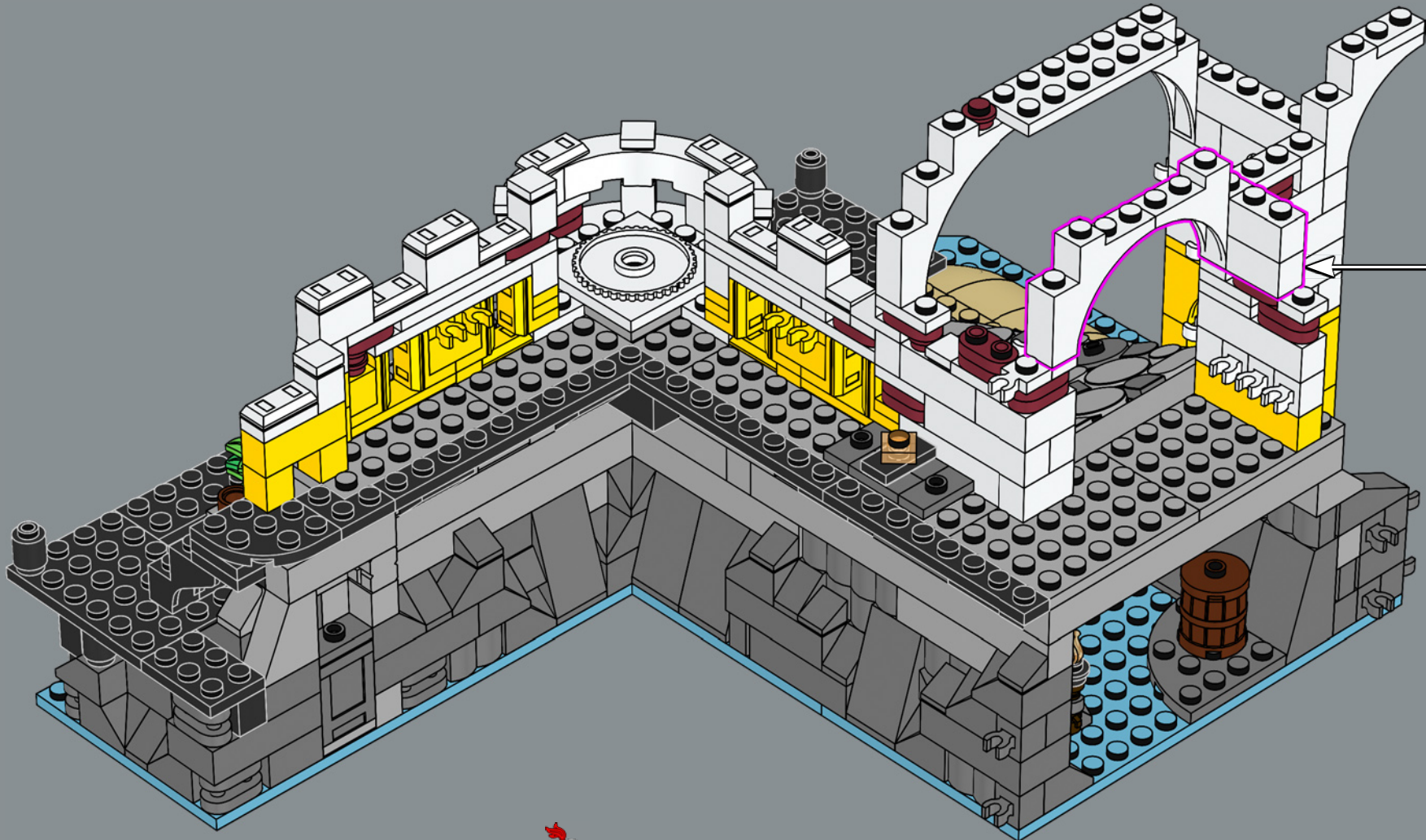

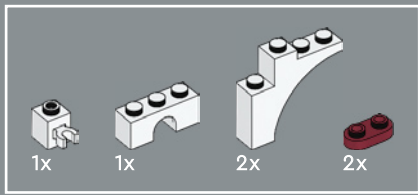

122

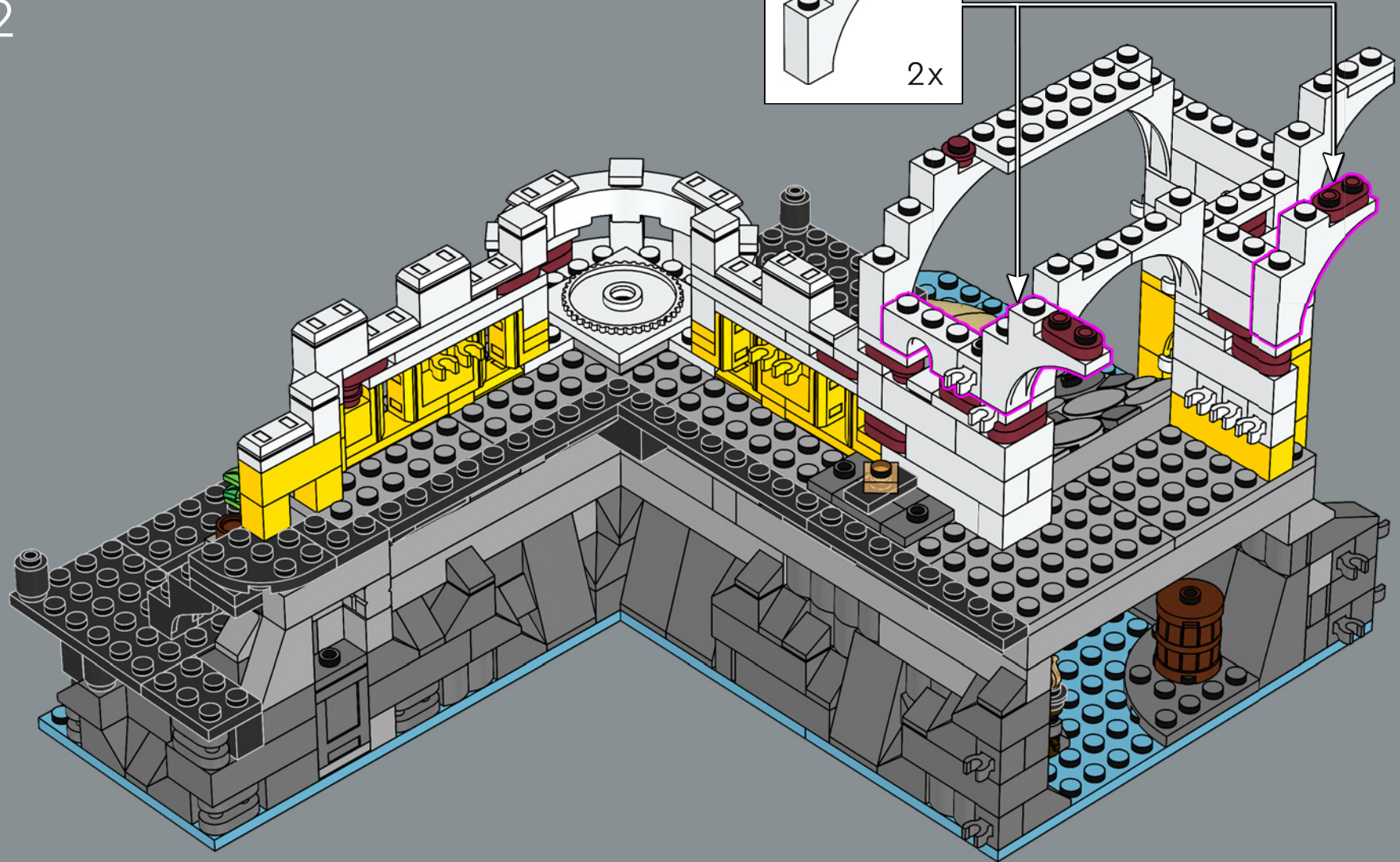
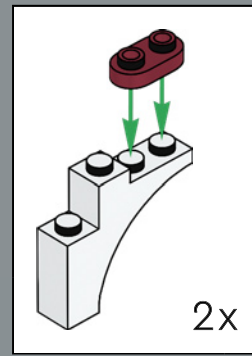



123

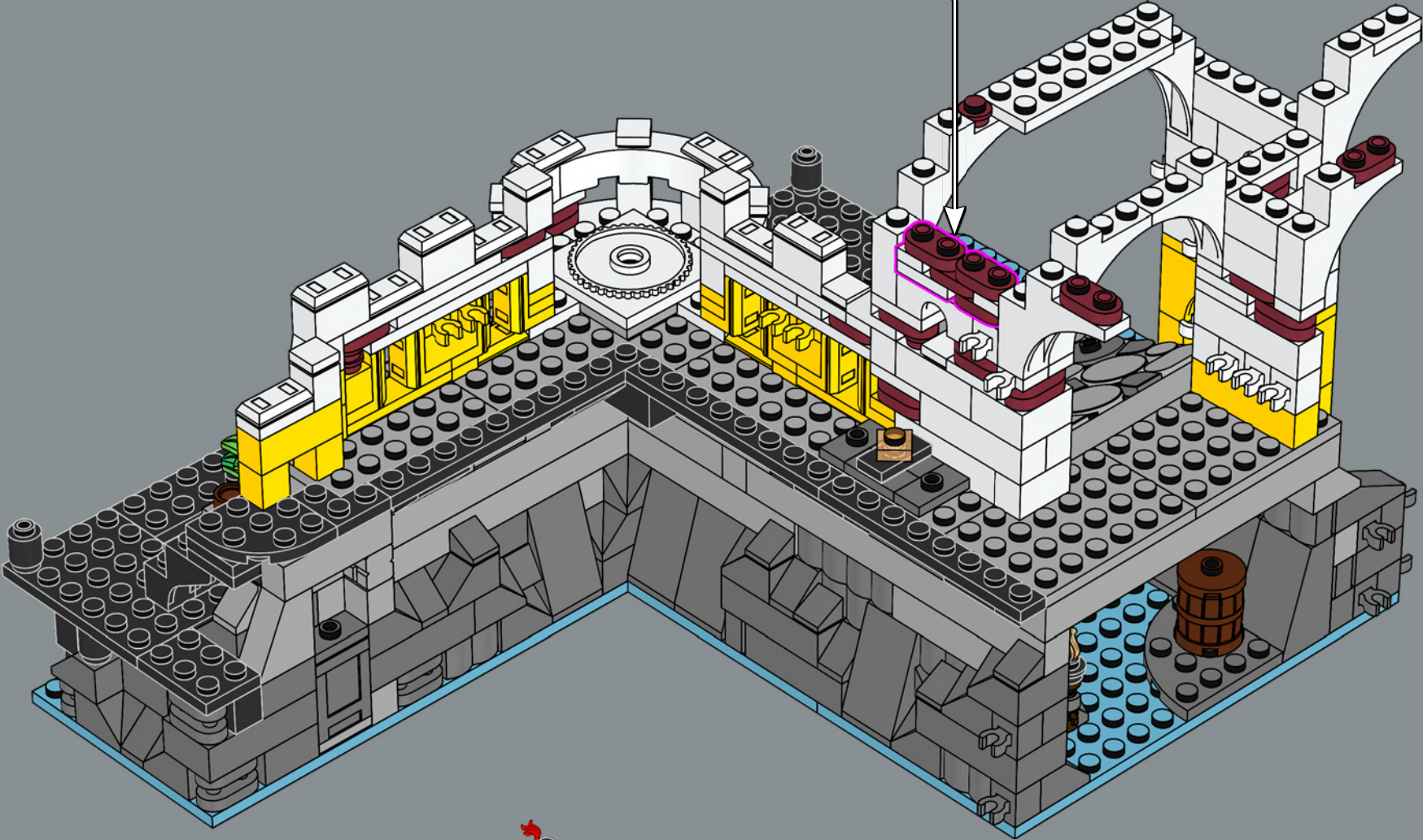
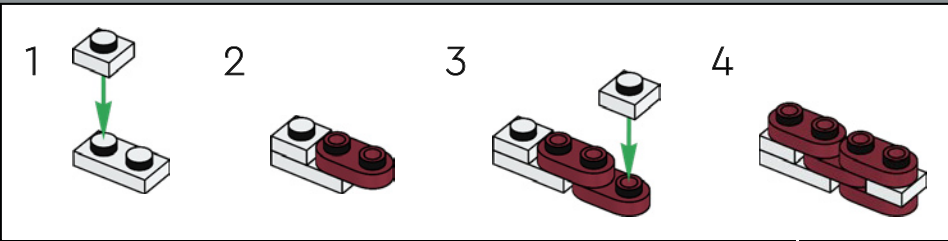

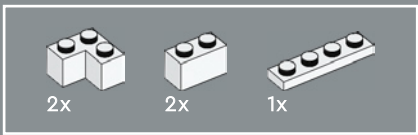

124

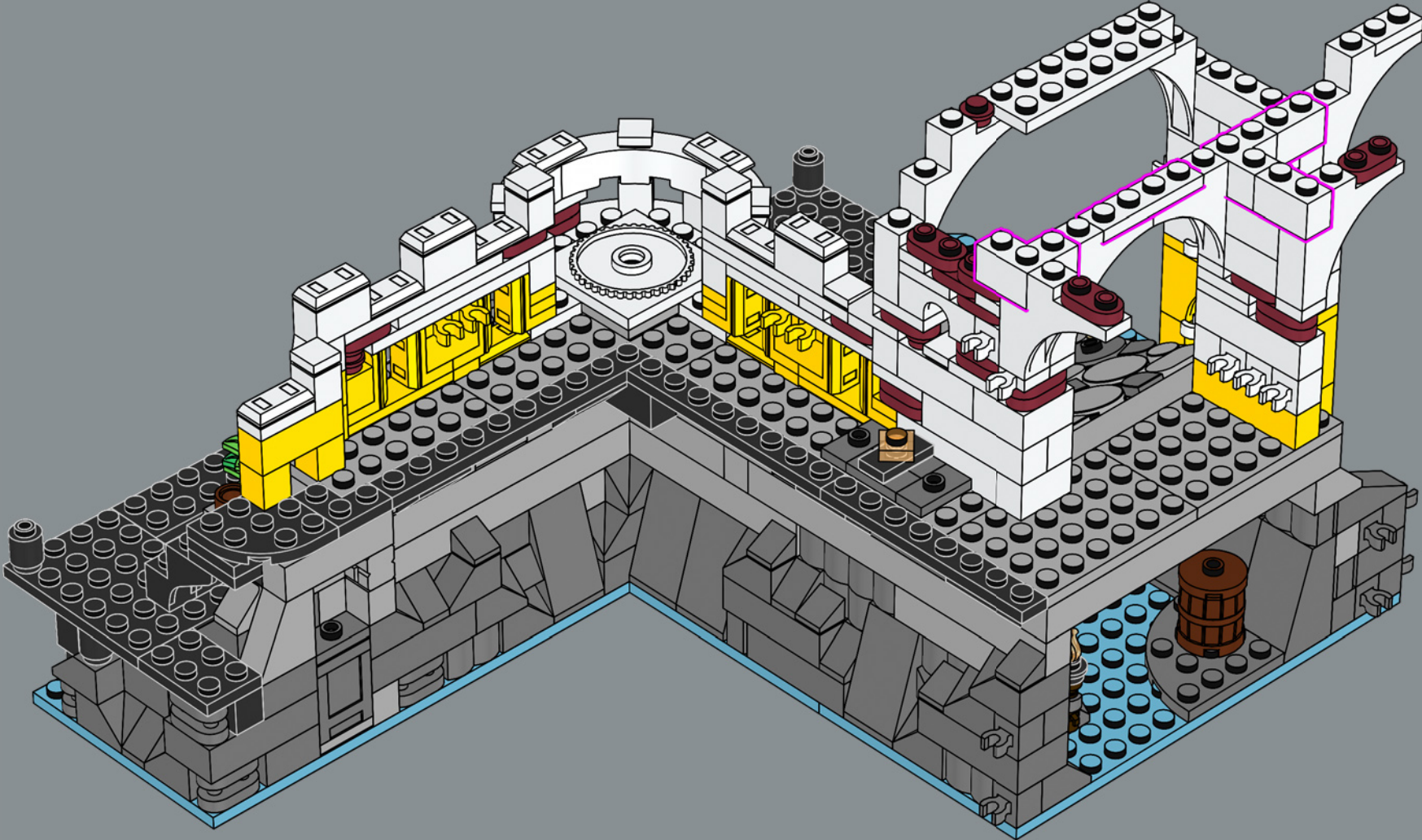

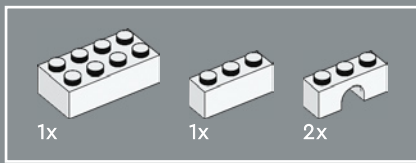

125

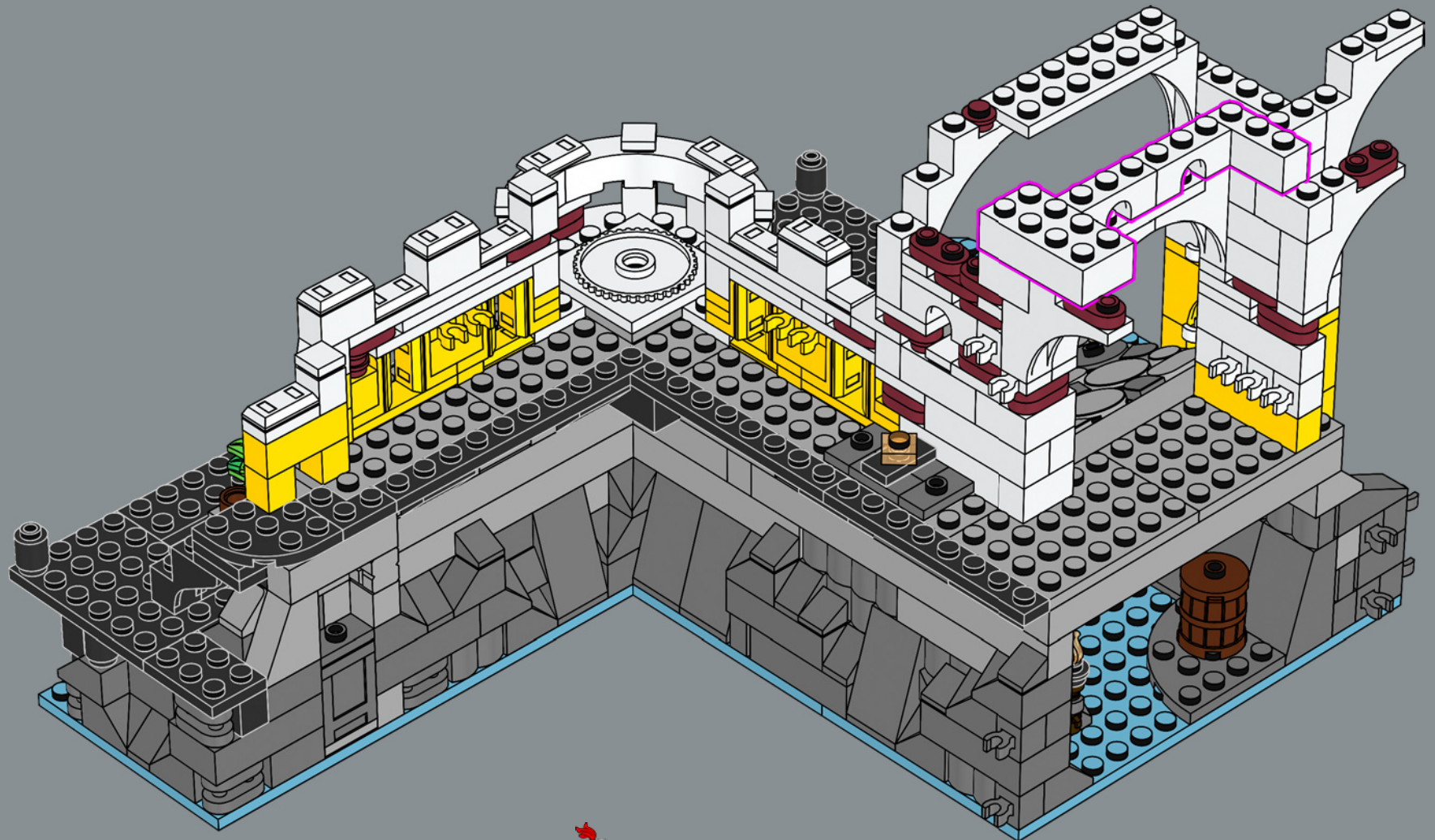

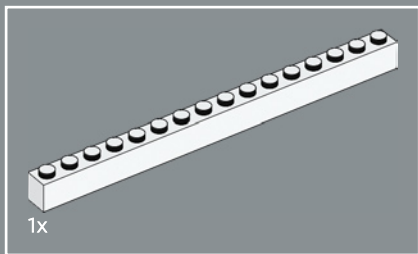

126

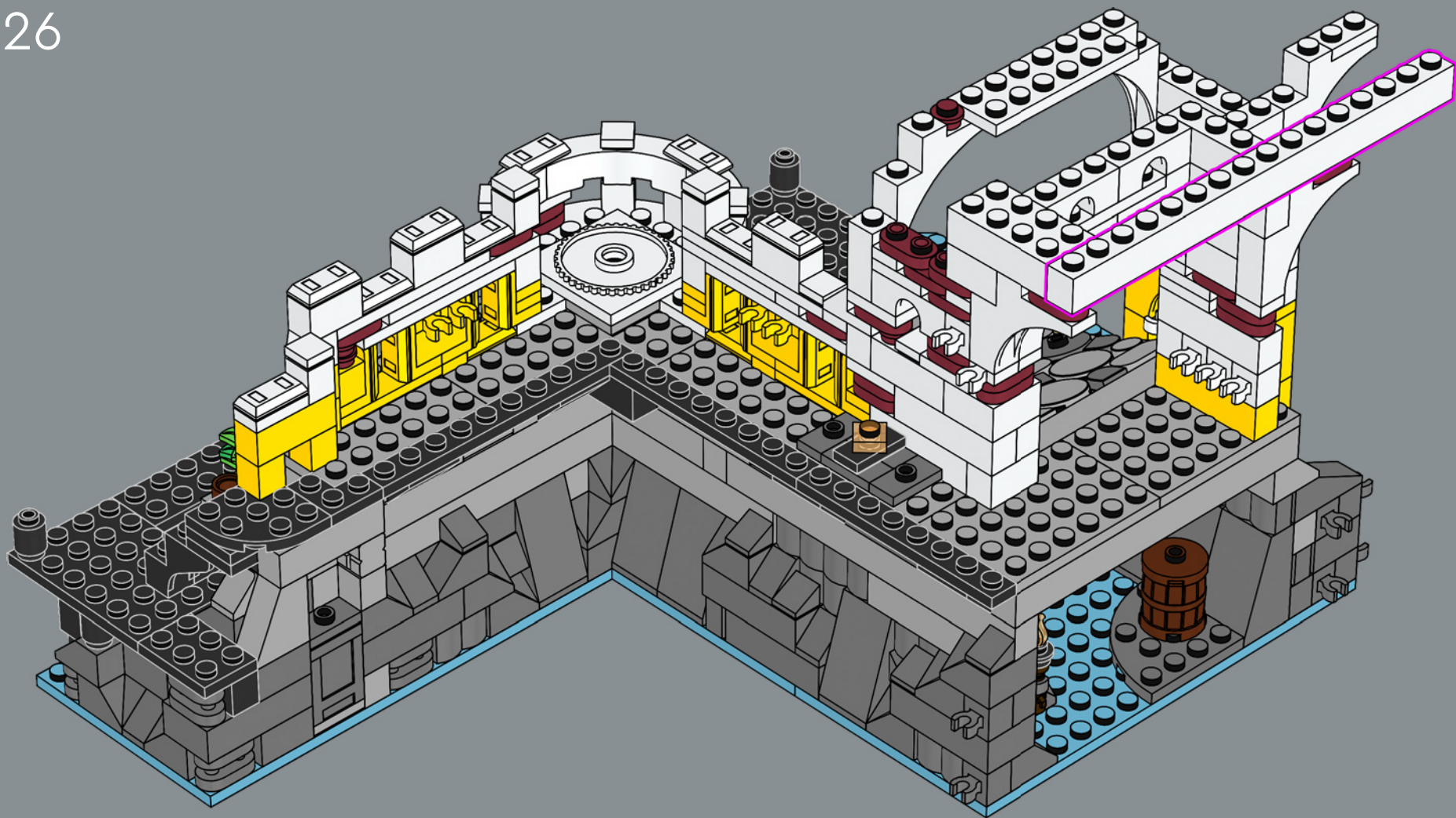

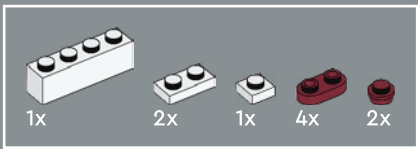

128

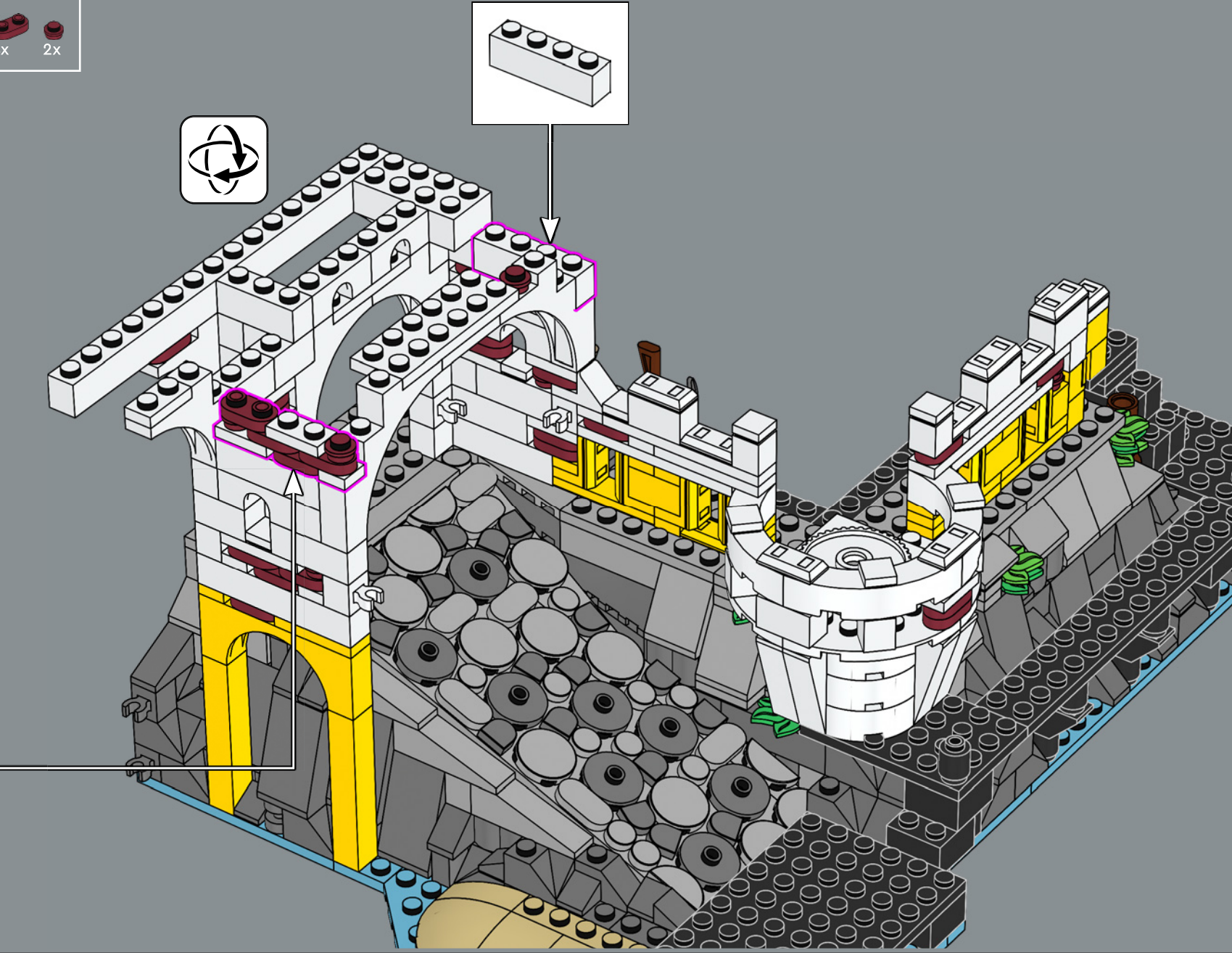
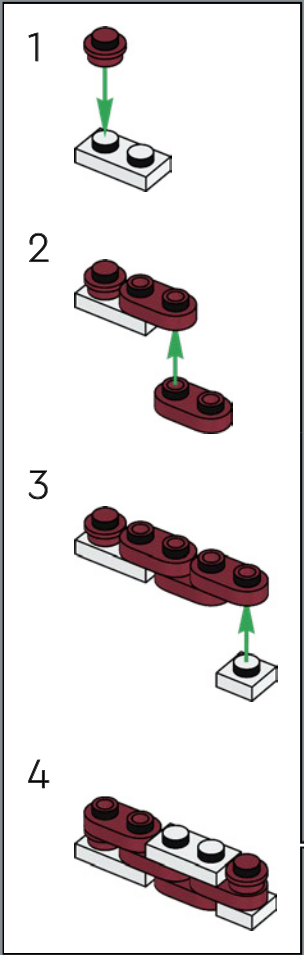
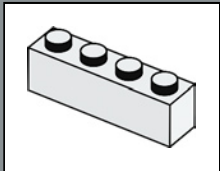

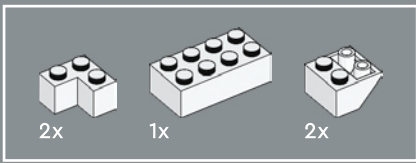

129

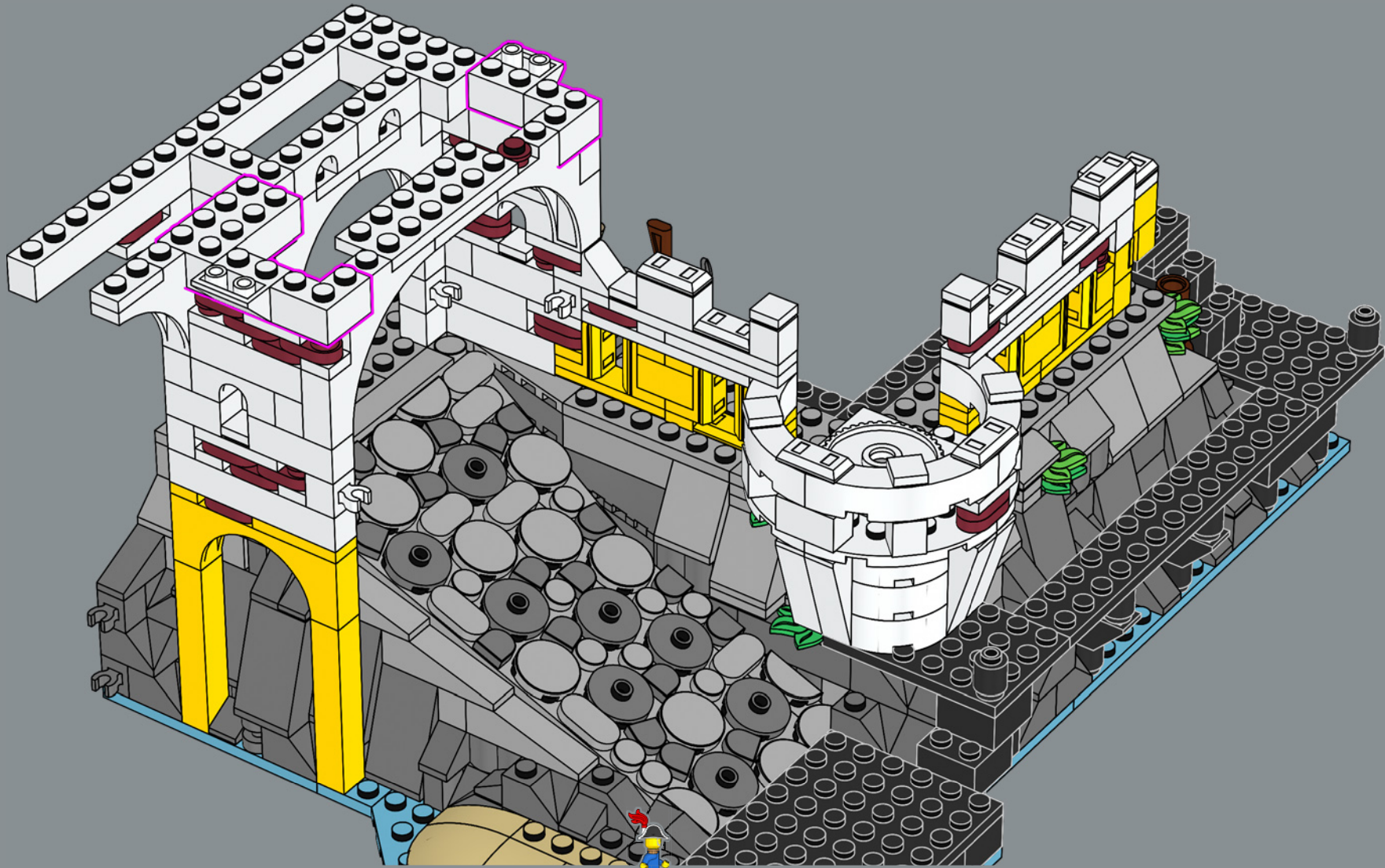

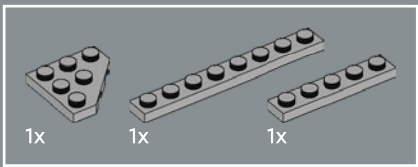

130

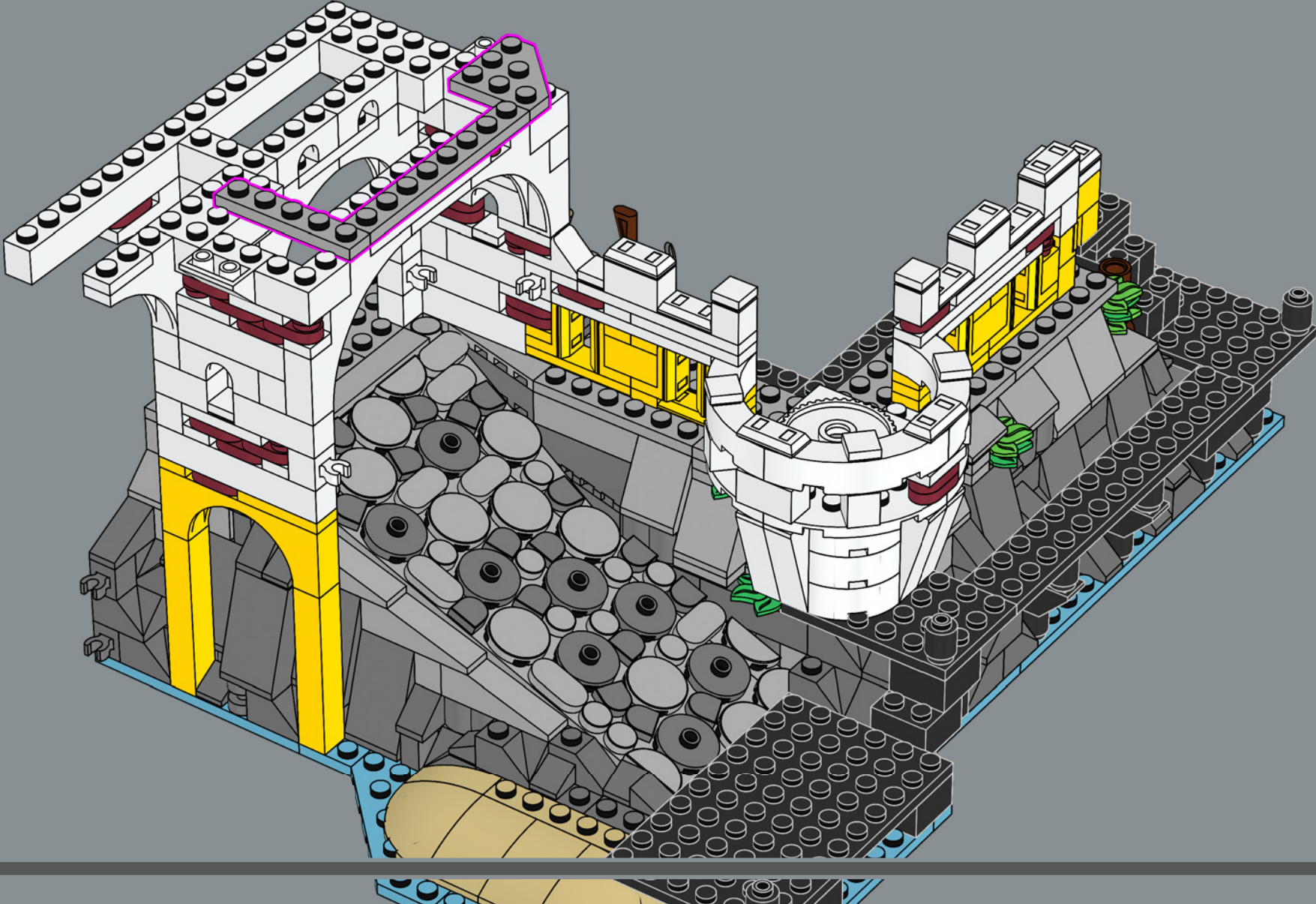

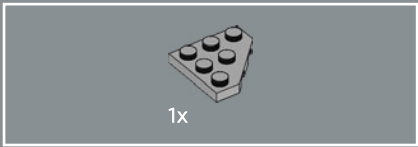

131

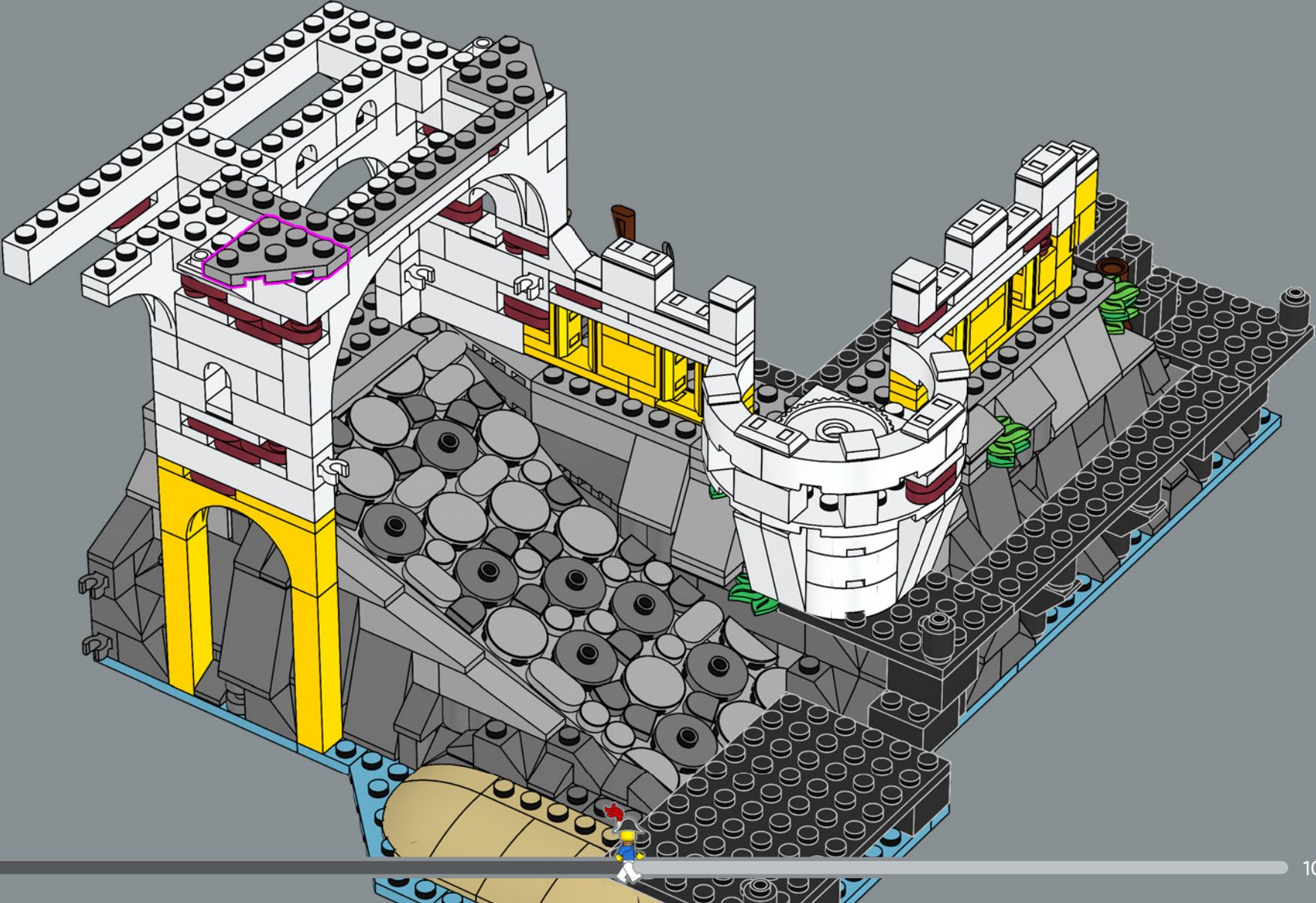

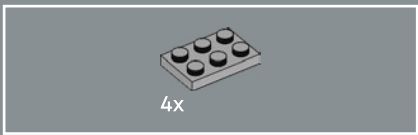

132

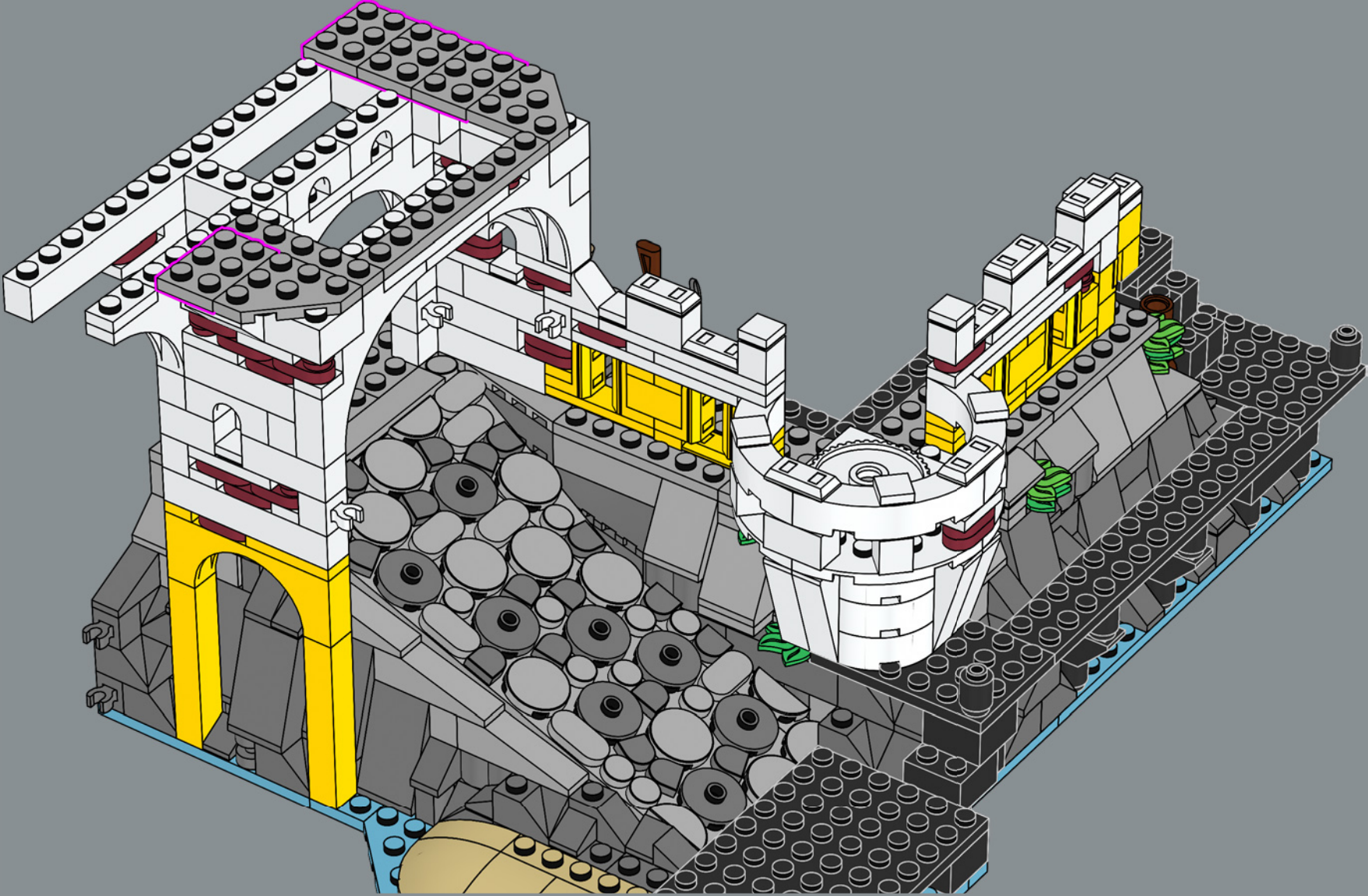

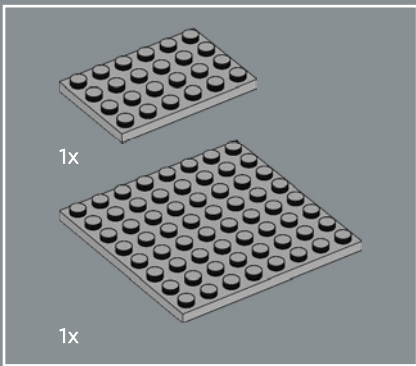

133

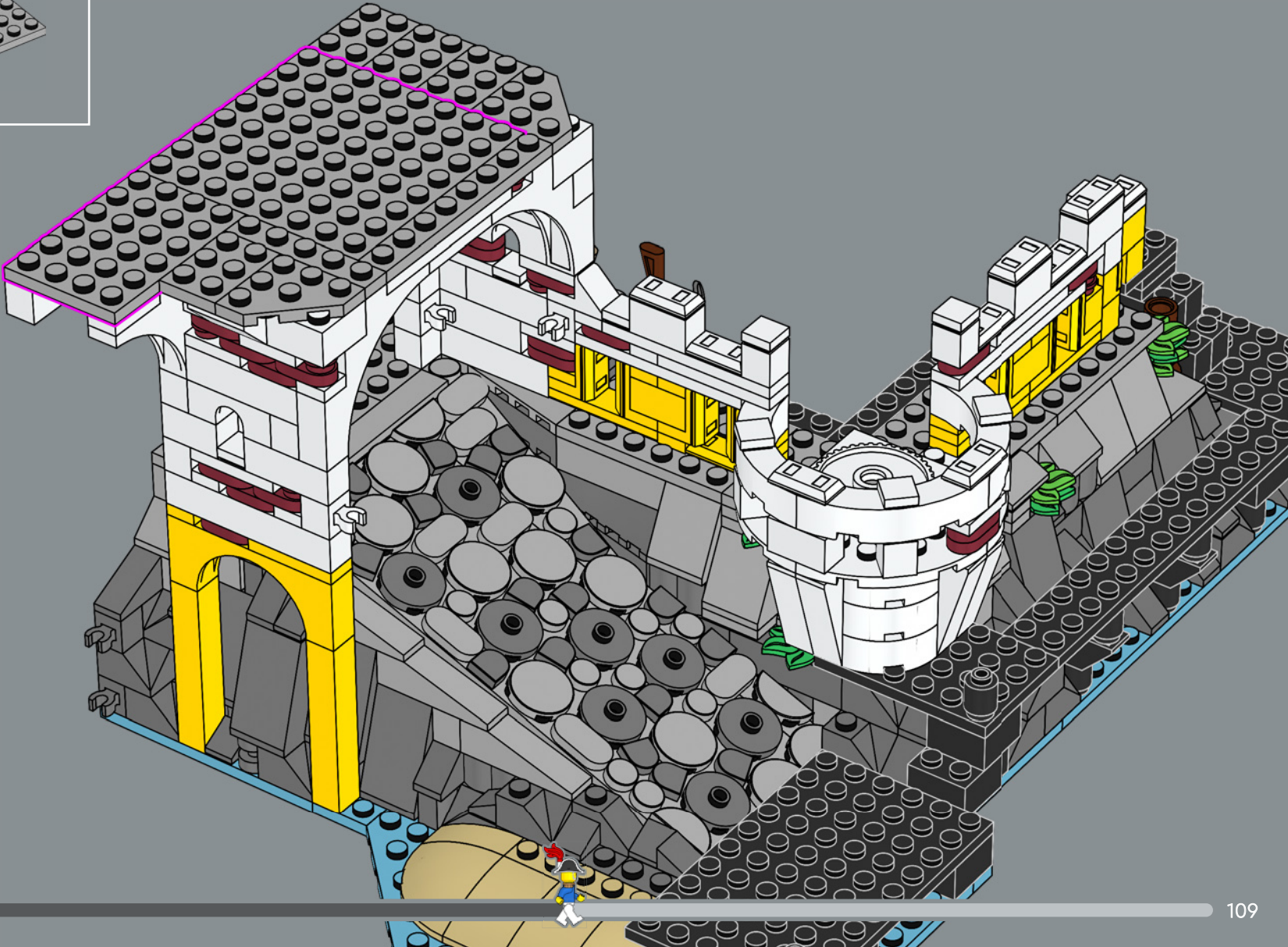

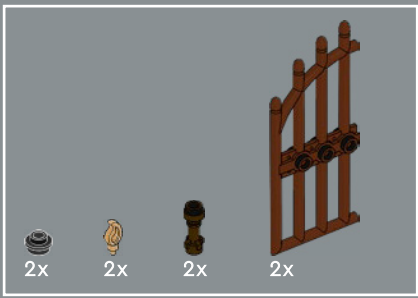

134

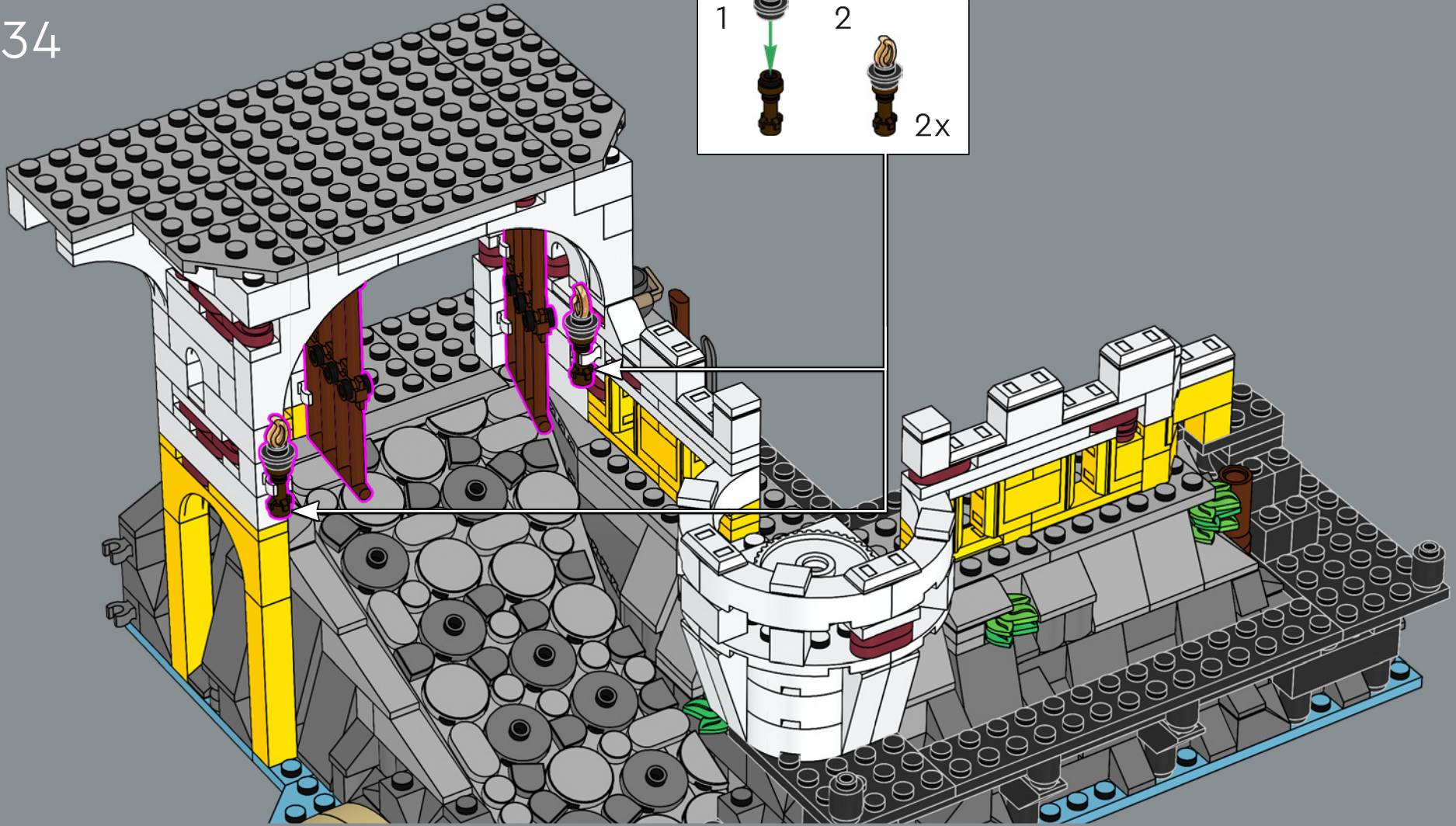
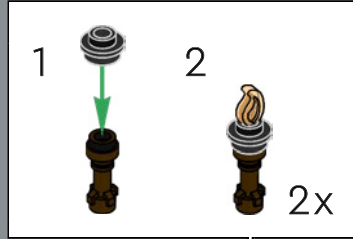

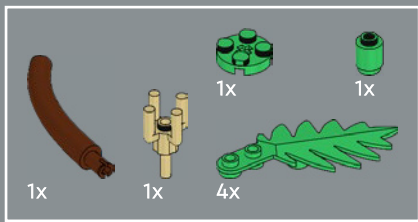

135

1

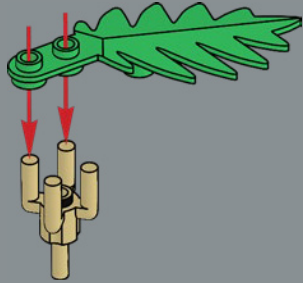

2

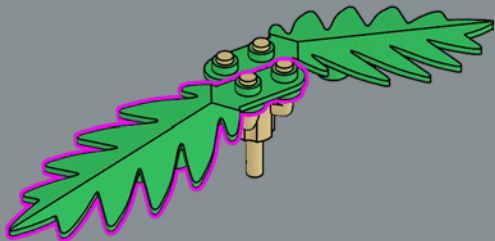

3



4



5



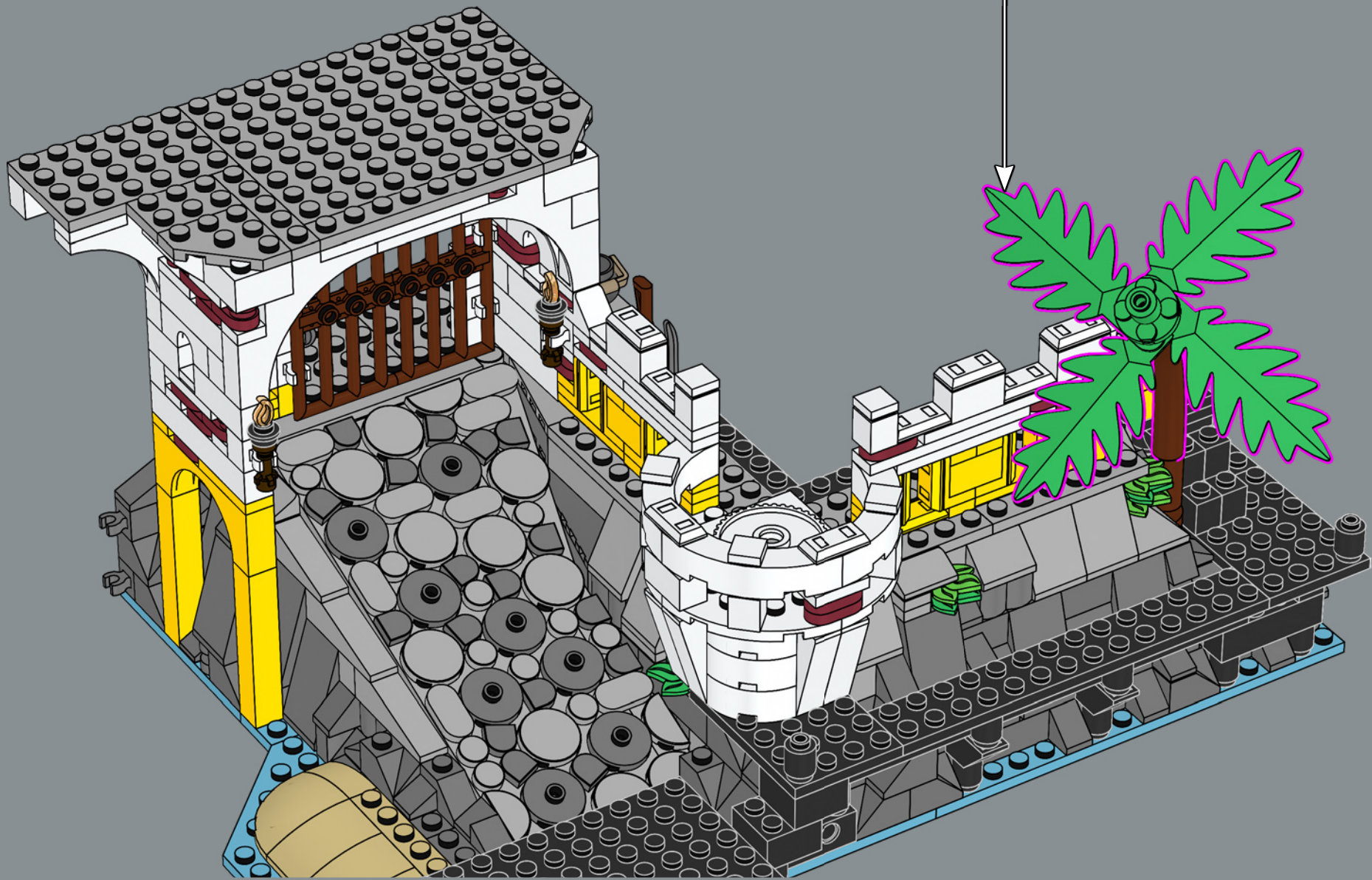

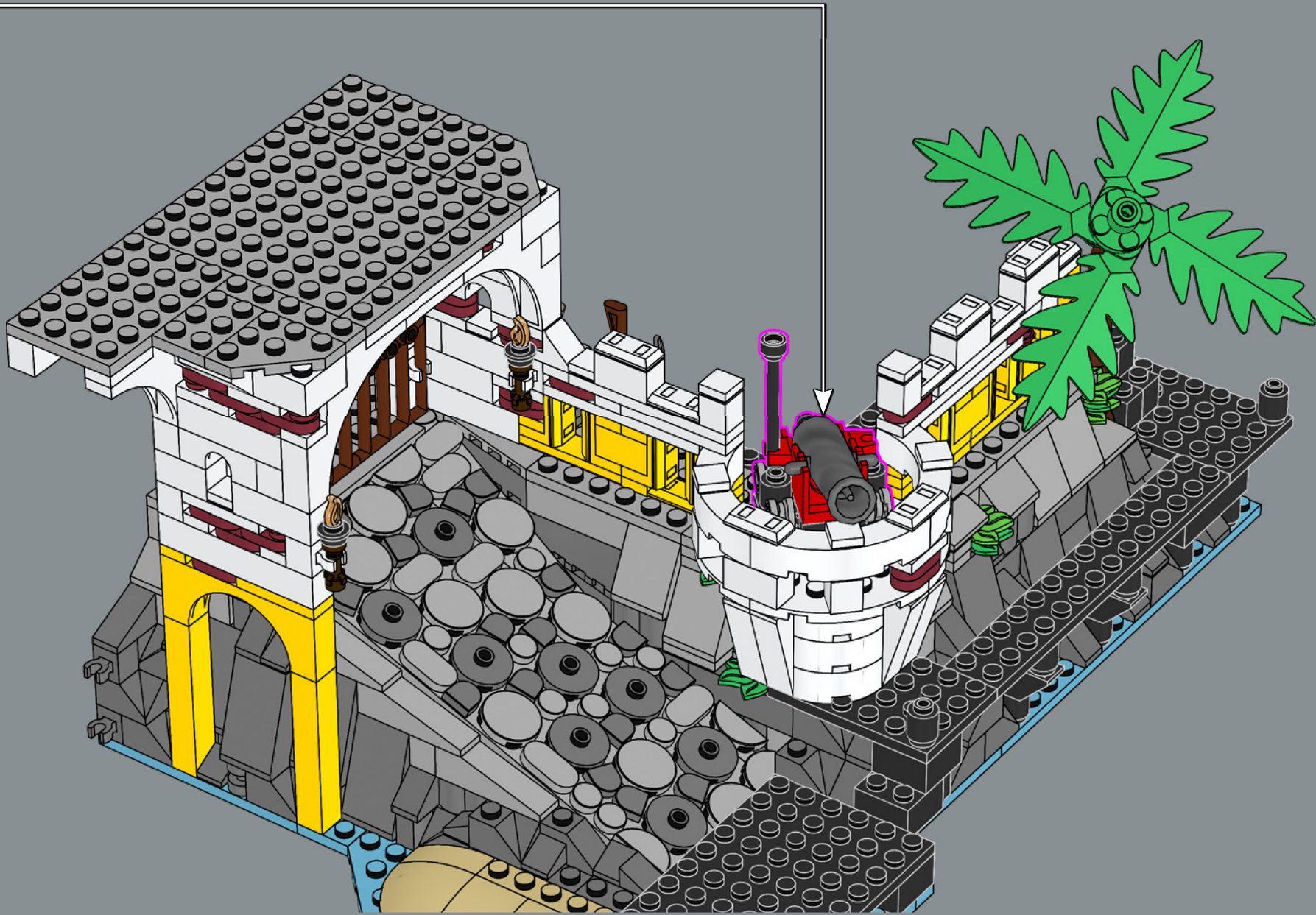

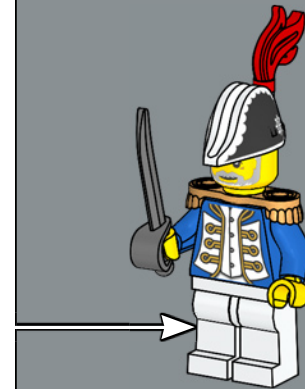
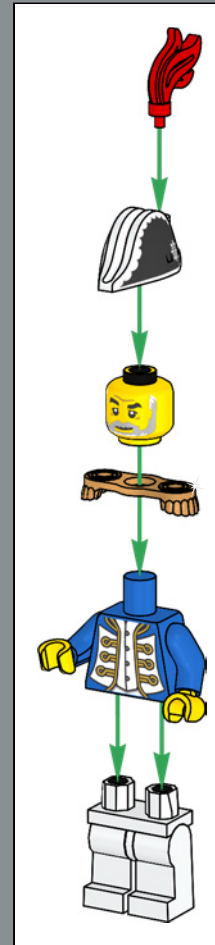



137

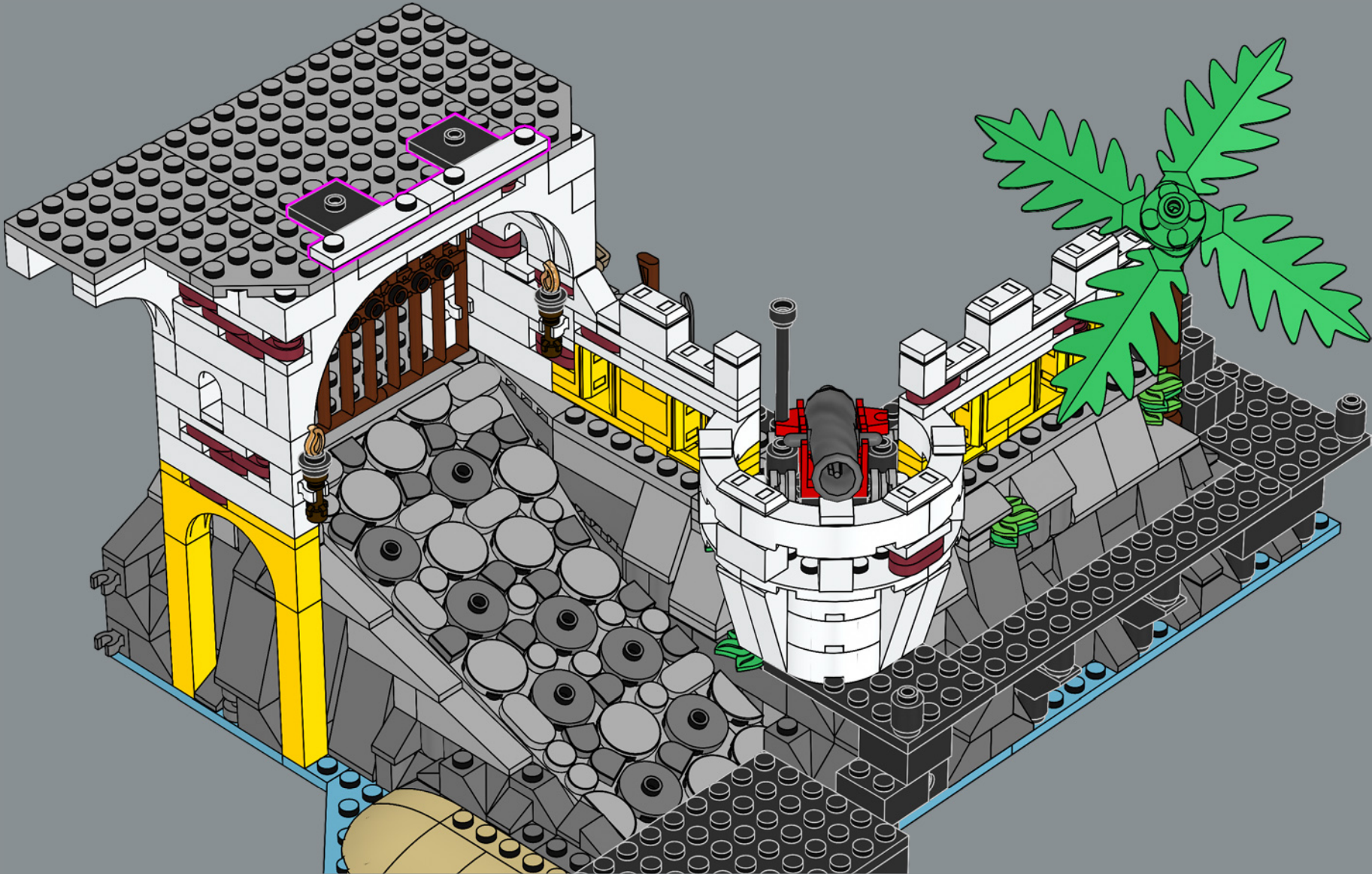

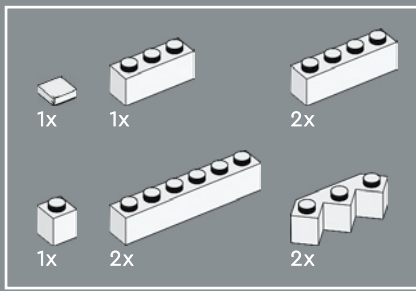

138



1x 5x 1x



139



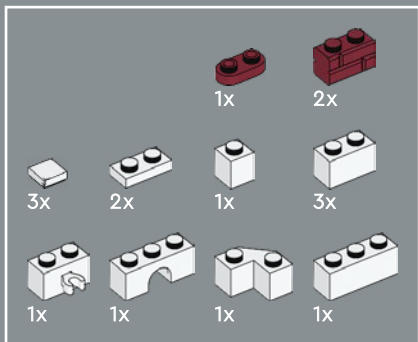

140

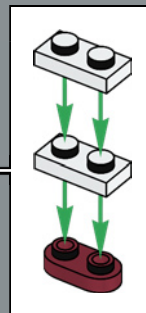

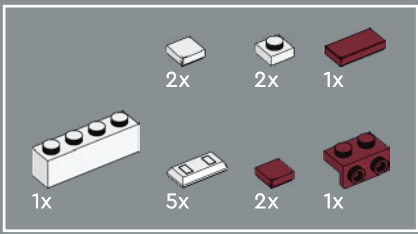

141

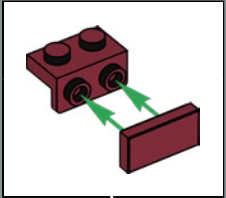



142

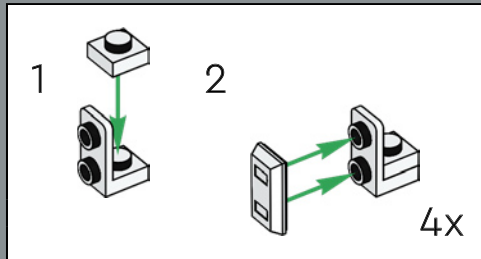



143

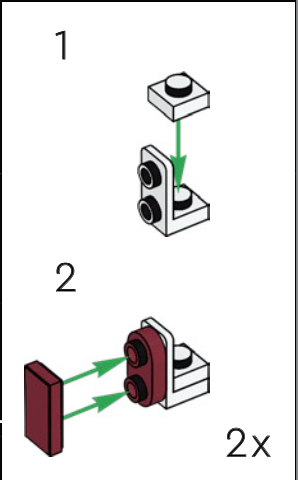

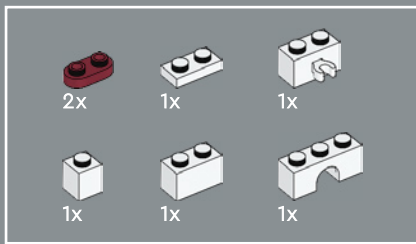

144



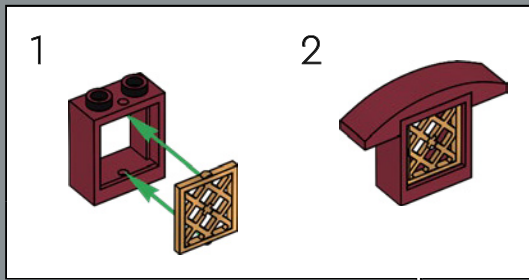
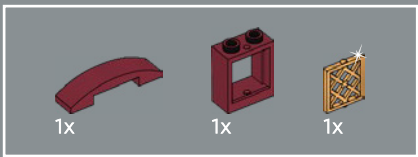

145



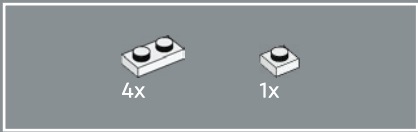

147



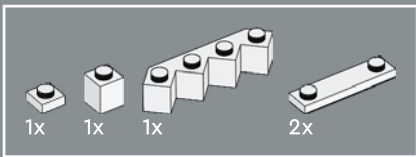

148

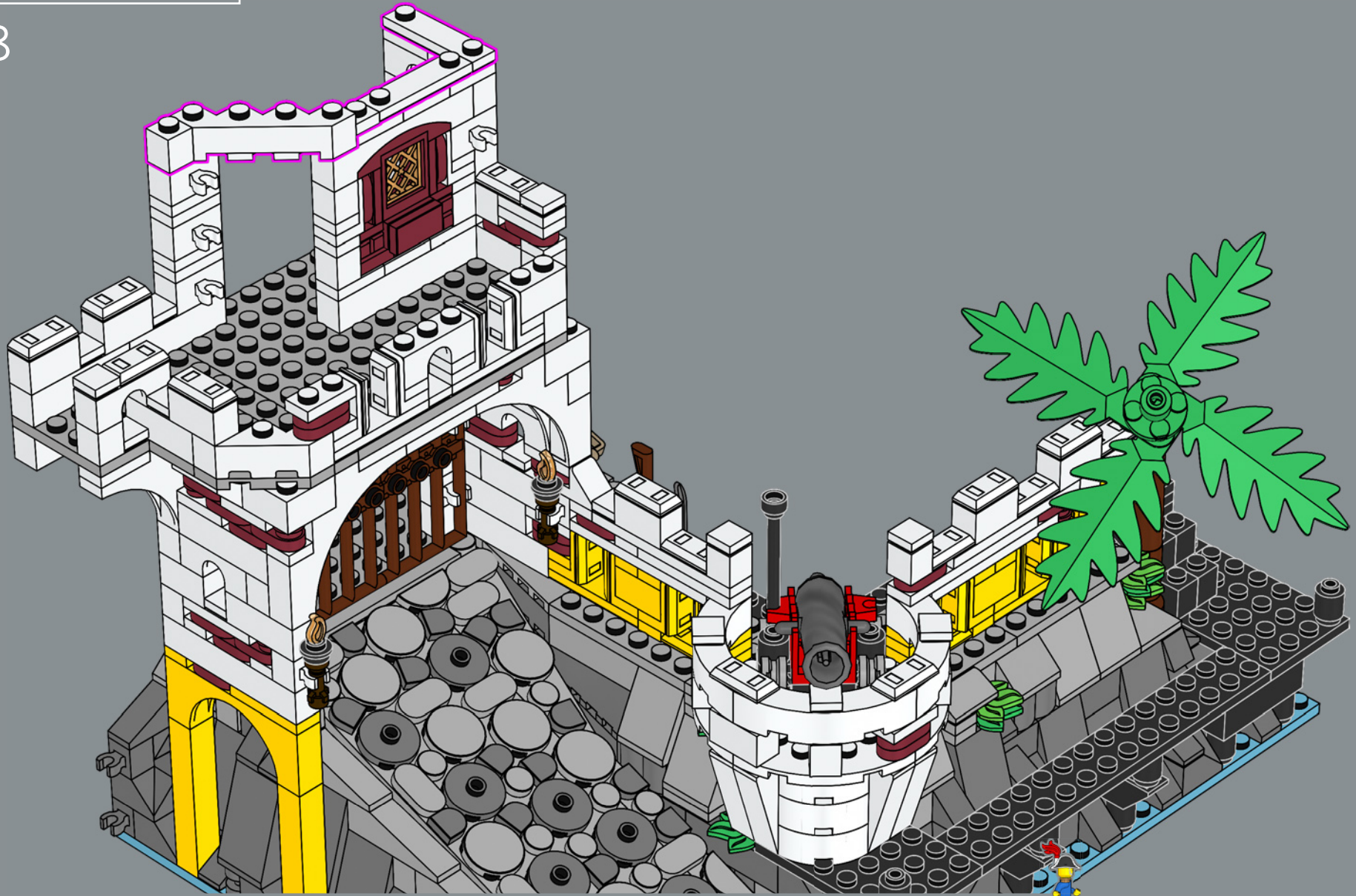

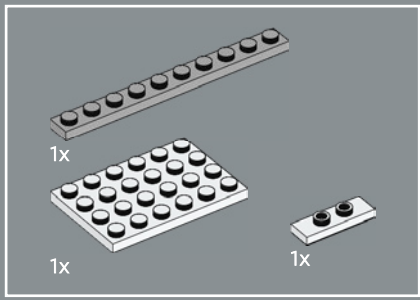

149

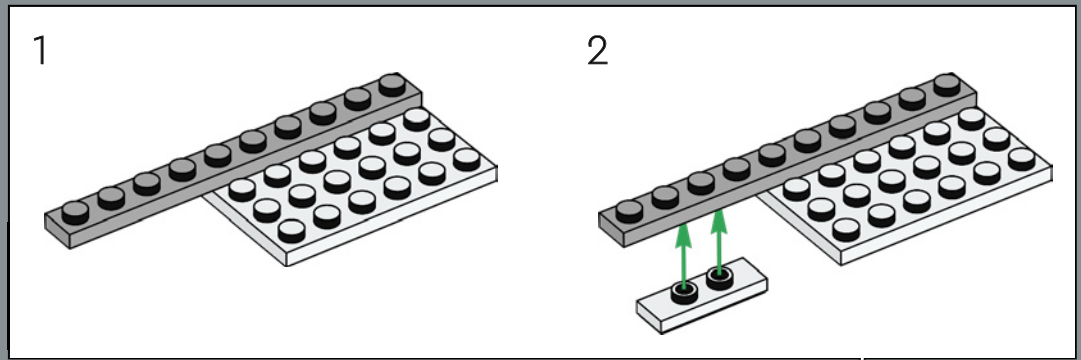

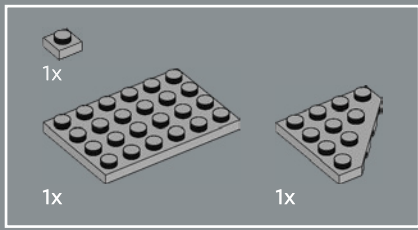

150



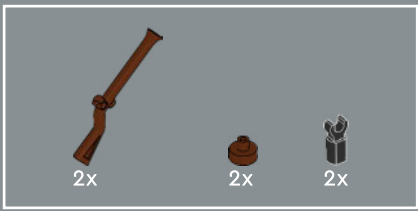

151

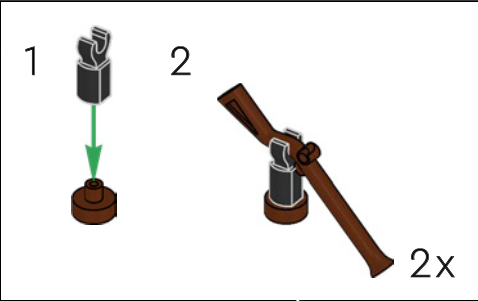

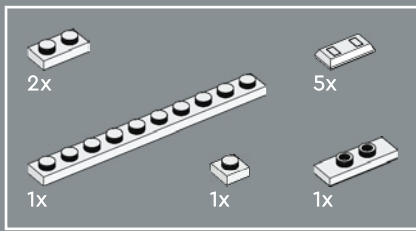

152

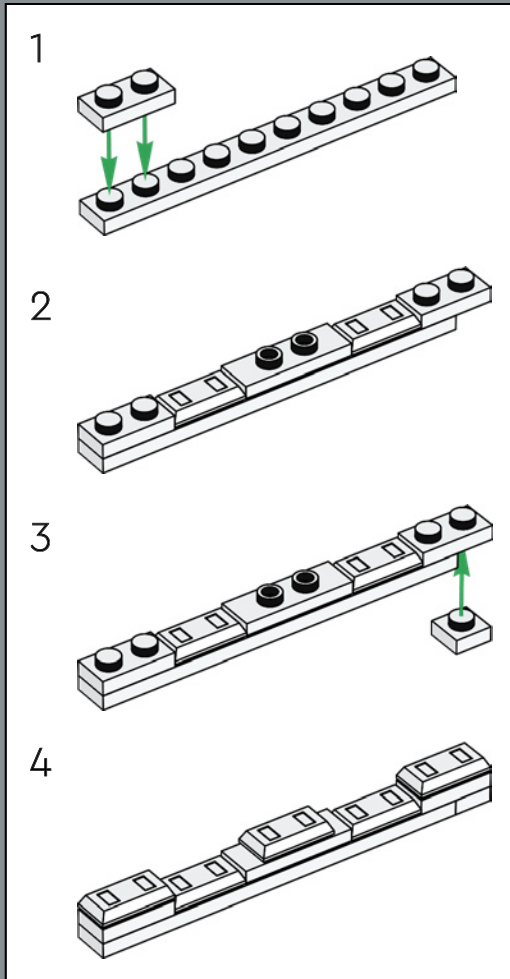

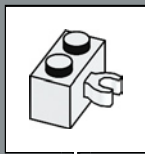
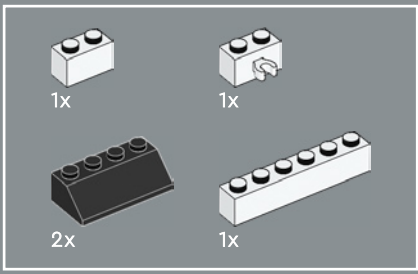

153



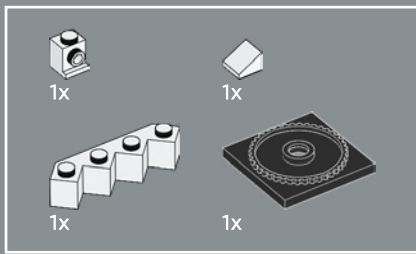

154



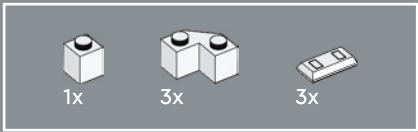

155





156



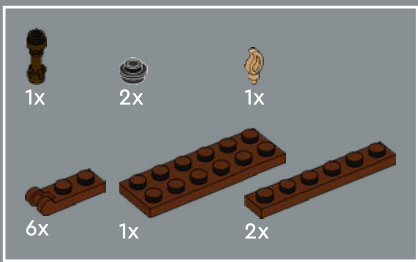

157

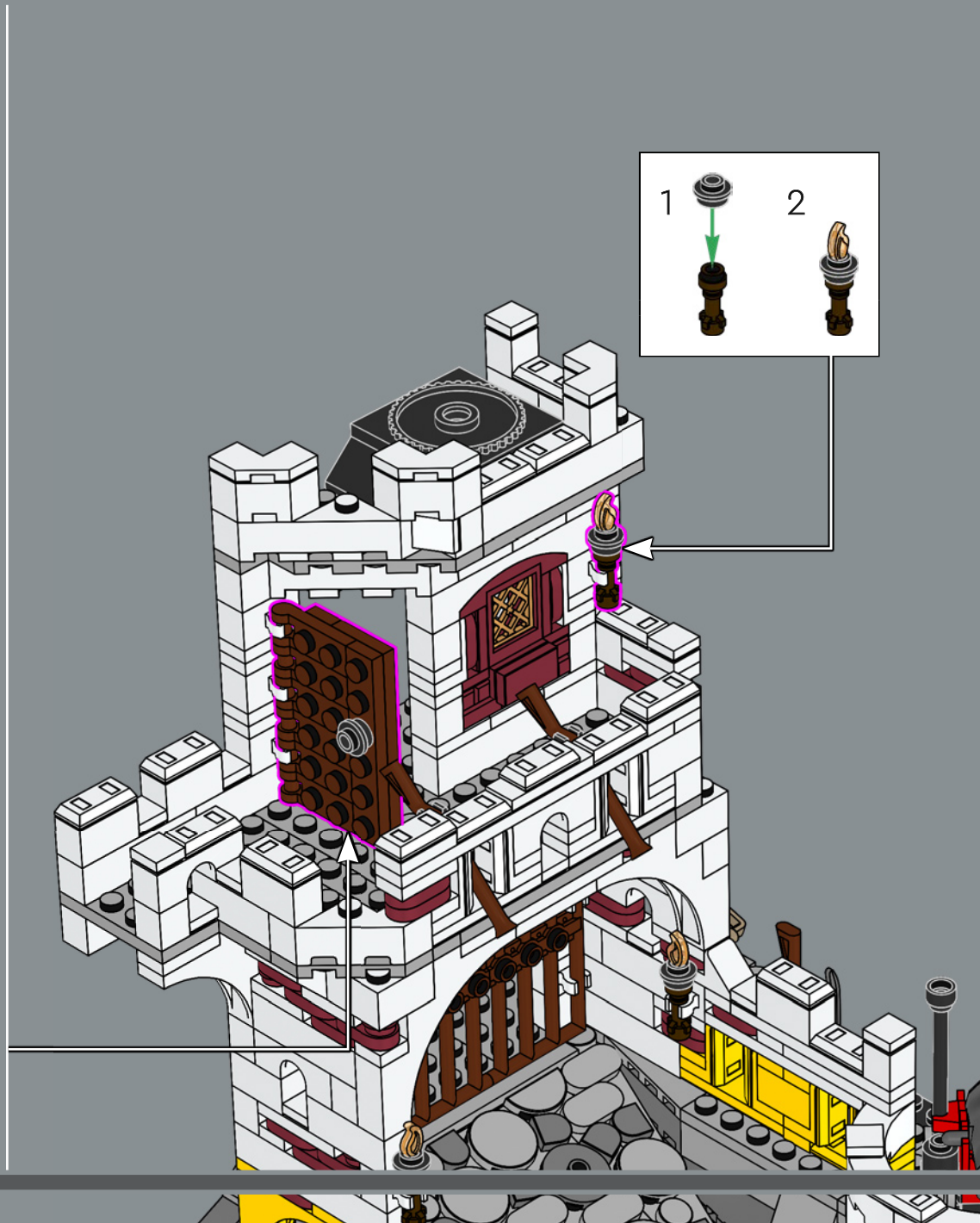
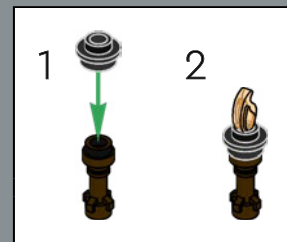
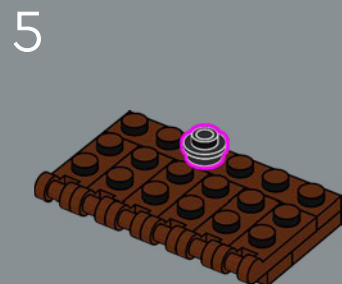
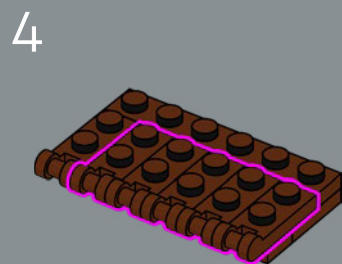
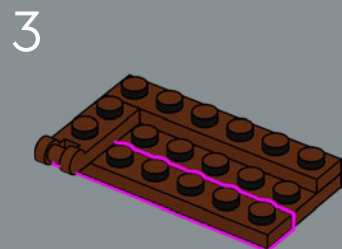
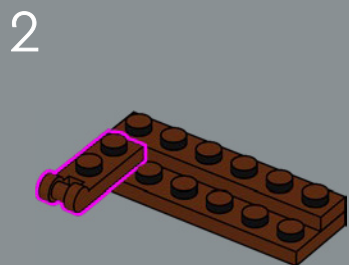
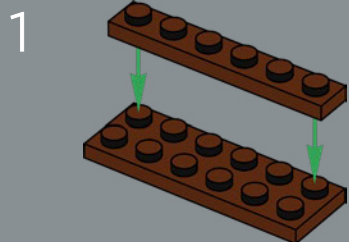



Nell'ufficio del Governatore sono custoditi i suoi beni più preziosi e i documenti più importanti.

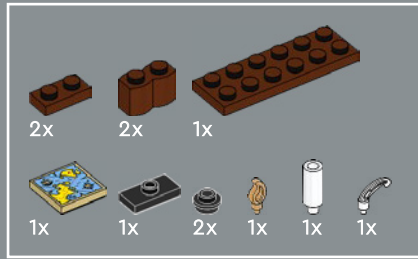

158

1

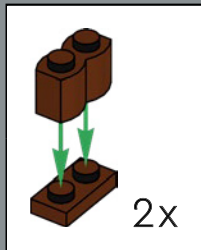
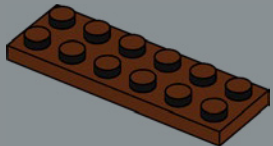

2

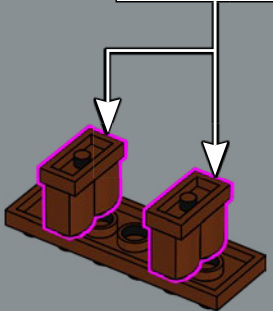

3



4

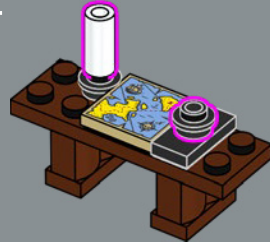

5



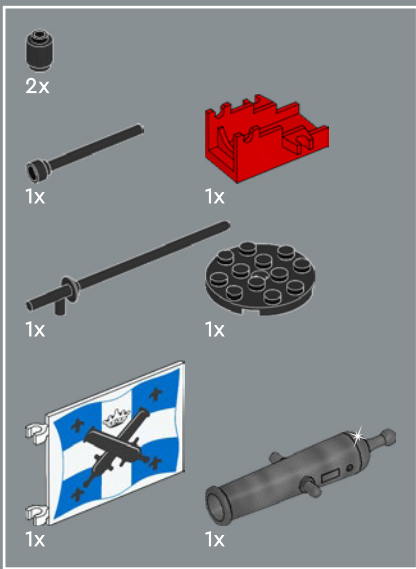

159

1



2

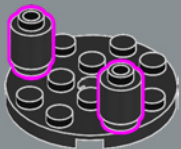

3

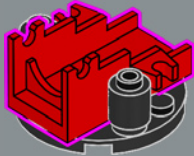

4

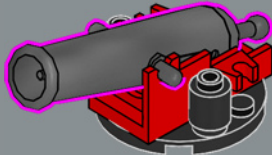

5

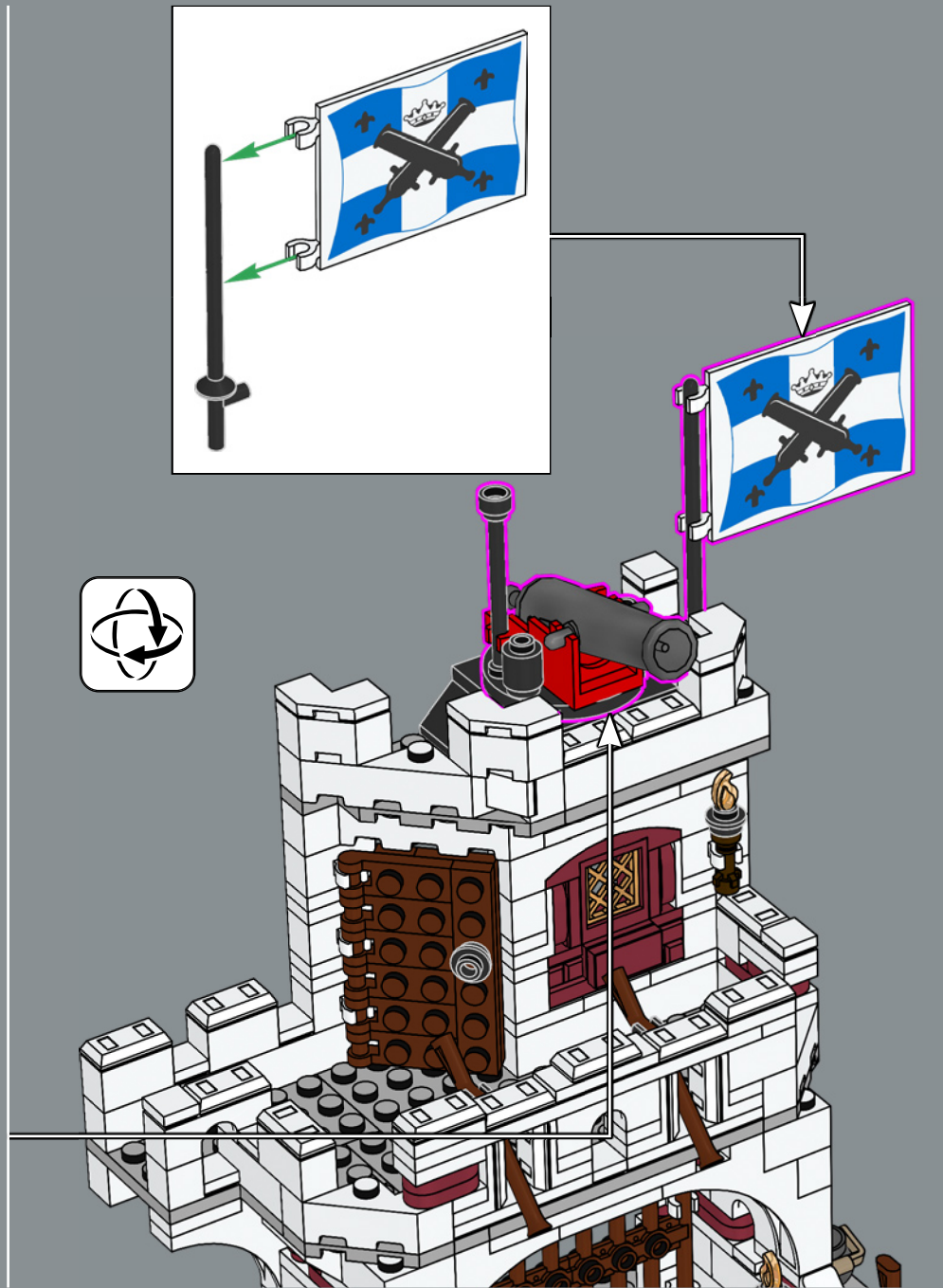
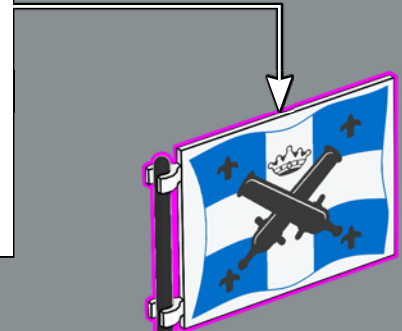
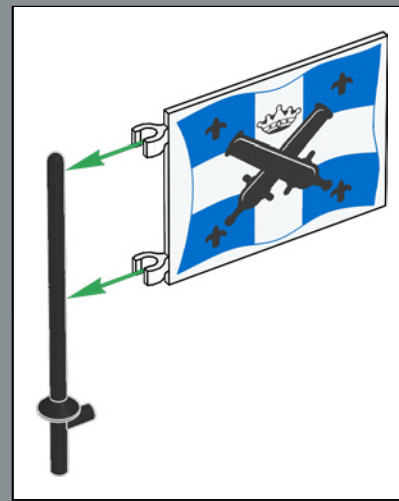
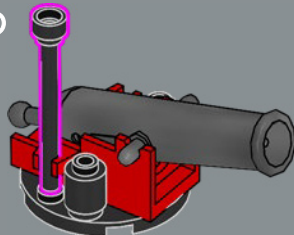





LEGO and the LEGO logo are trademarks of the LEGO Group.
©2023 The LEGO Group.