



duplo



10919

LEGO.com/DUPL0

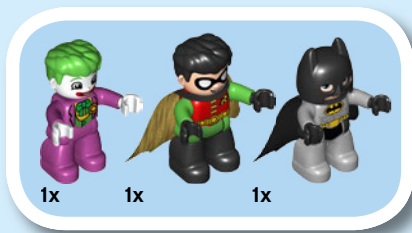

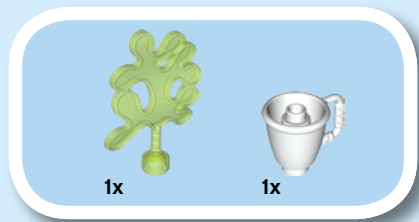

**1**



**2**





1





2



3



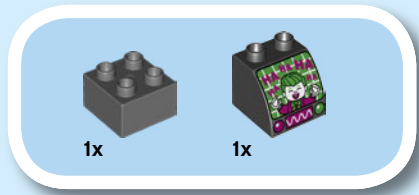

1

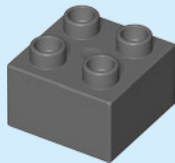

2



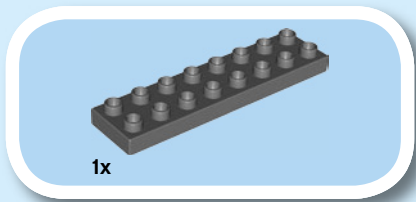

1

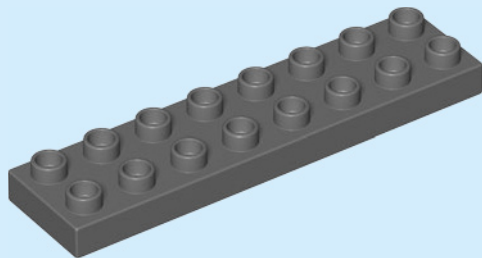

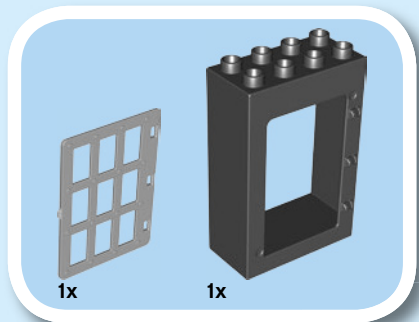

2

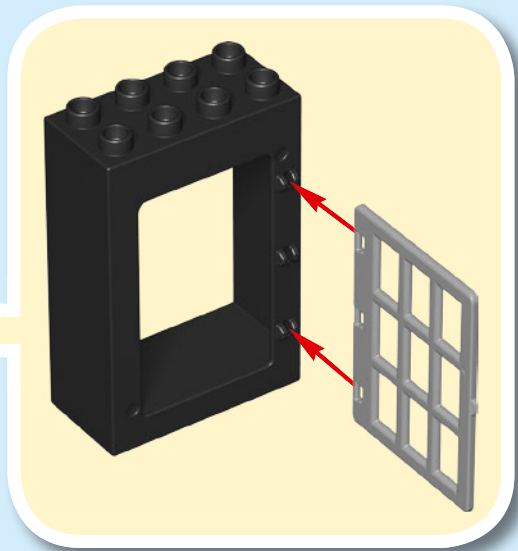
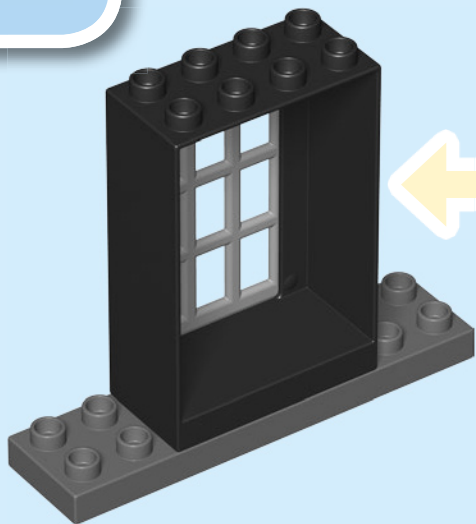

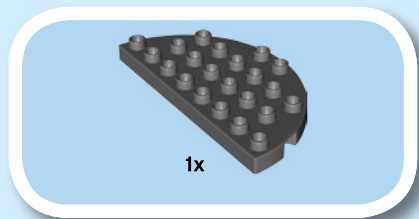

3

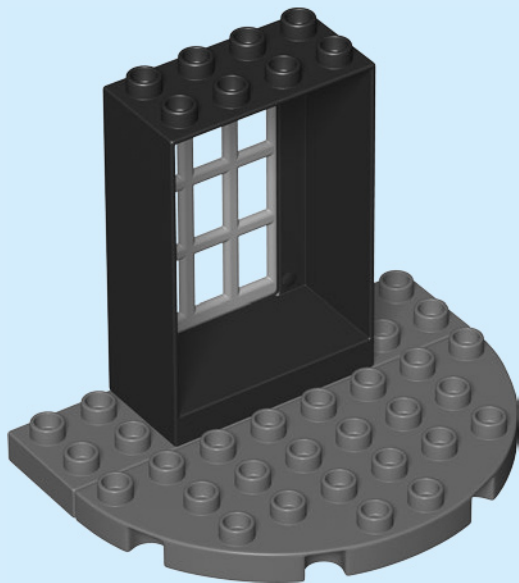

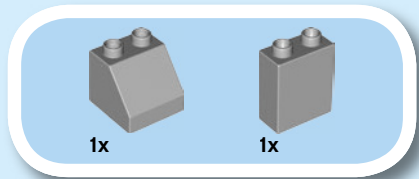

4

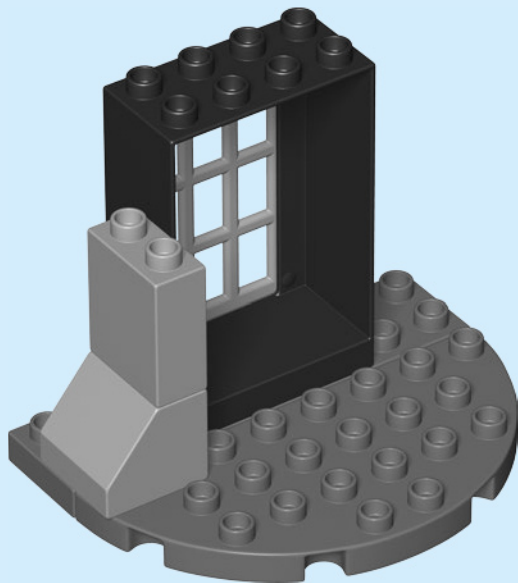

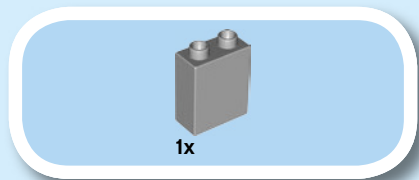

5

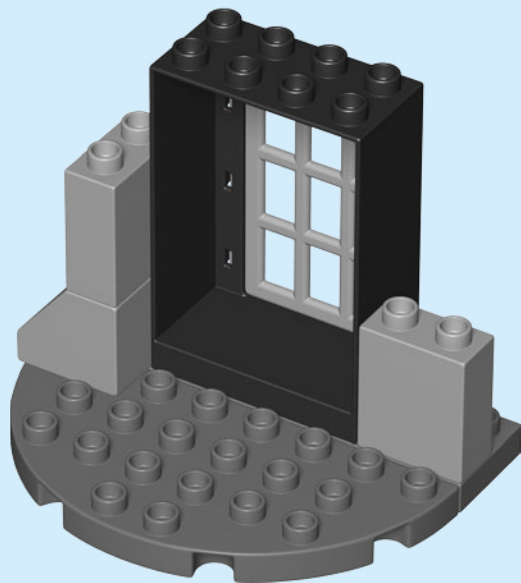

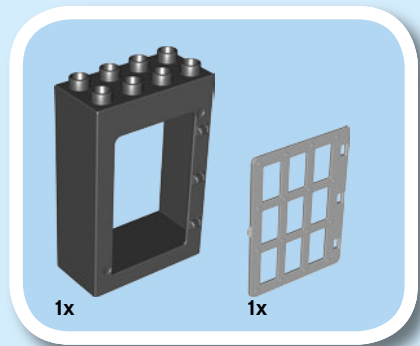

6

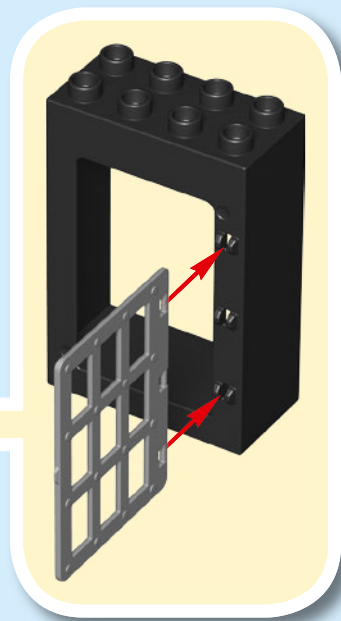
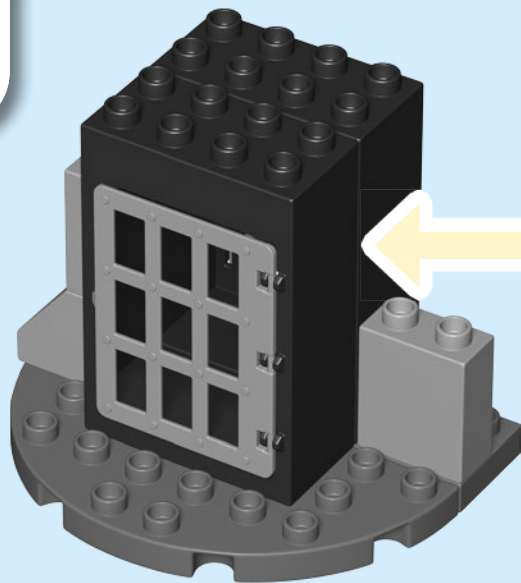



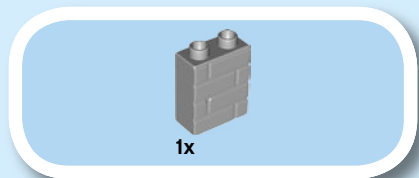

7

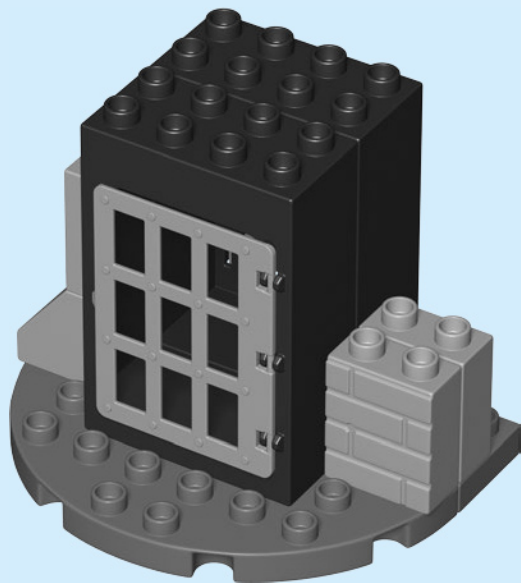

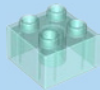

1x

8

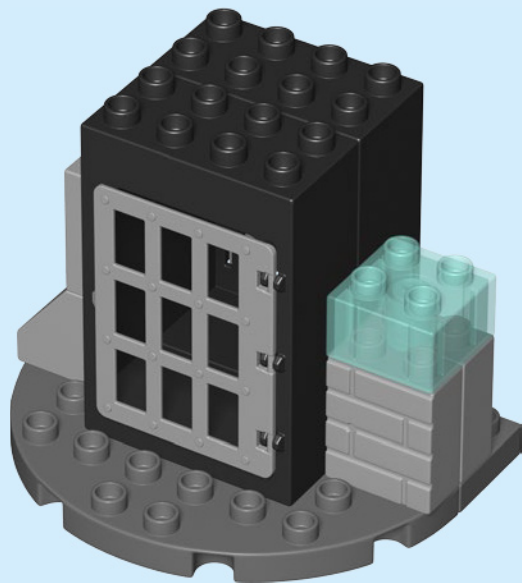

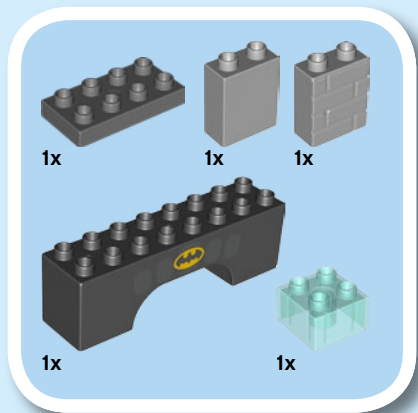

9

1

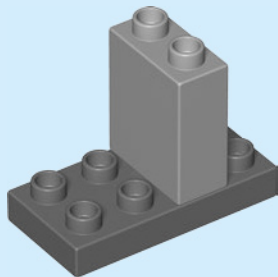

2

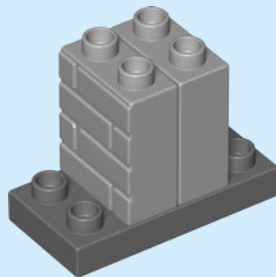

3

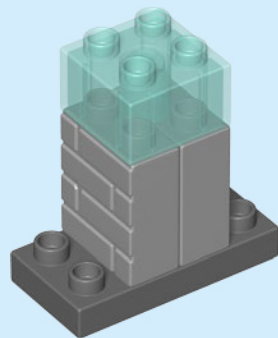

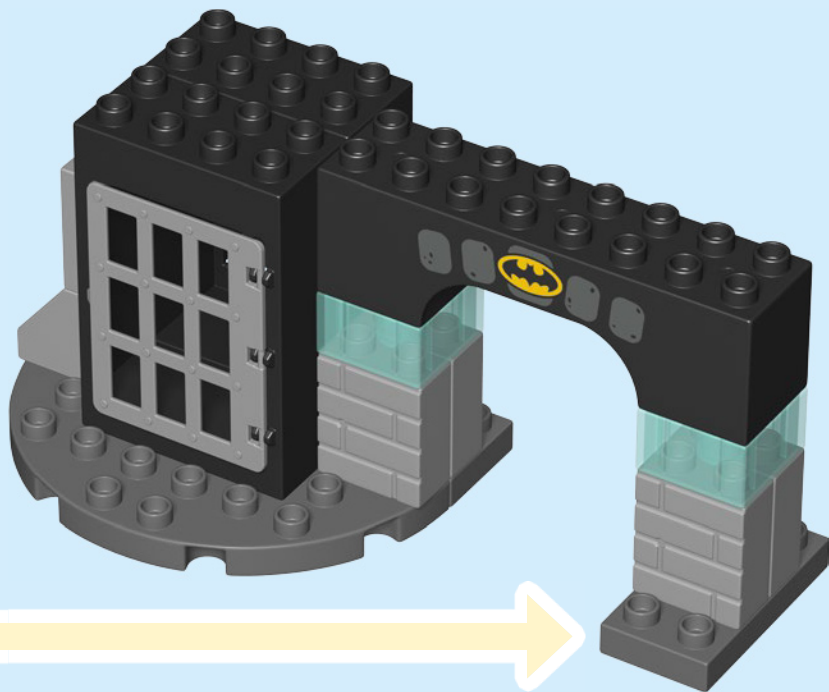

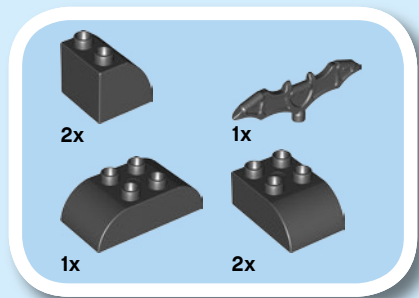

10

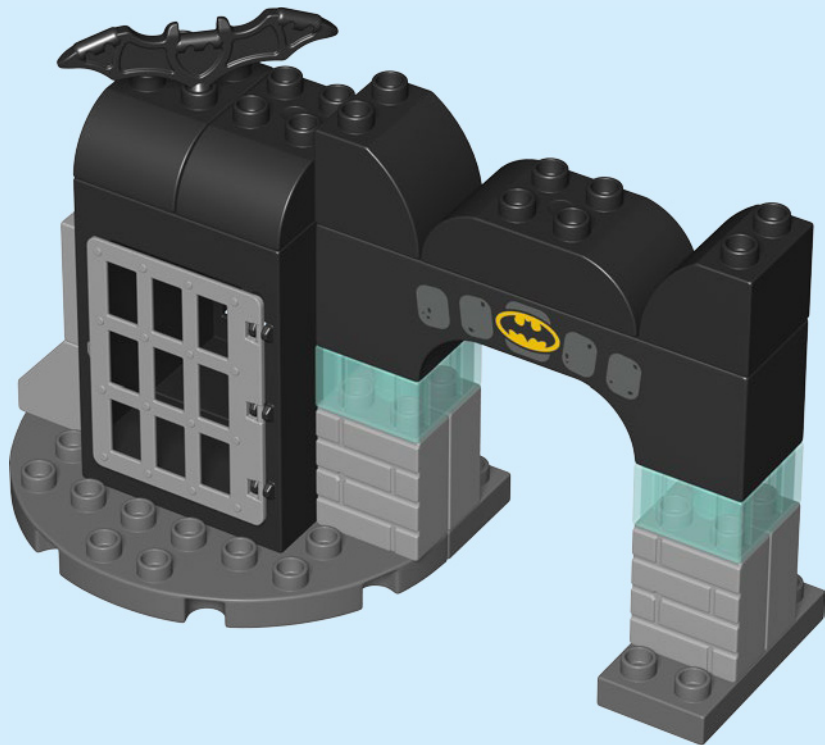



# duplo

Ages/edades

# 1 1/2

10915  
Ages 1 1/2+



10913  
Ages 1 1/2+



EXTRA  
IDEAS  
INCLUDED

D'AUTRES  
IDÉES  
INCLUSES

INCLUYE  
IDEAS  
EXTRA

LIGHT  
BRICK

# 2+

10933  
Ages 2+



LIGHT & SOUND

LIGHT & SOUND

PUSH & GO

BRIQUE  
LUMIERE  
LADRILLO  
LUMINOSO

LUMIERE  
ET SON  
LUZ Y  
SONIDO

ACTIONNE  
PAR POUSSEE  
PUSH-&-GO



**A WORLD OF LEGO® DUPLO®**  
**LE MONDE DE**  
**LEGO® DUPLO®**  
**UN MUNDO DE**  
**LEGO® DUPLO®**

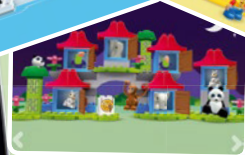

The availability of apps is subject to the local strategies of the LEGO Group.

La disponibilité des applications est soumise aux stratégies locales du Groupe LEGO.

La disponibilidad de las apps está sujeta a las estrategias regionales de The LEGO Group.



Customer Service  
Kundenservice  
Service Consommateurs  
Servicio Al Consumidor

LEGO.com/service or dial

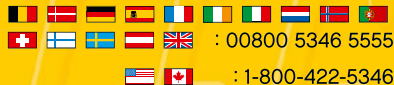
 : 00800 5346 5555  
: 1-800-422-5346





Go to [www.LEGO.com/productfeedback](http://www.LEGO.com/productfeedback)  
and give us your short  
**win**  
**feedback** about this  
LEGO® DUPLO® set for a chance to win  
a cool LEGO prize

Terms & Conditions apply

## LEGO.com/productfeedback

### GEWINNE

Erzähle uns auf  
[www.LEGO.com/productfeedback](http://www.LEGO.com/productfeedback)

etwas über die Erfahrungen, die du  
mit diesem LEGO® Set gemacht hast,  
und sichere dir die Chance auf einen  
coolen LEGO Preis!

Es gelten die Teilnahmebedingungen

### GAGNE

Rends-toi sur  
[www.LEGO.com/productfeedback](http://www.LEGO.com/productfeedback)

et donne-nous quelques commen-  
taires sur ce produit LEGO® pour  
avoir une chance de gagner un  
prix LEGO !

Voir Conditions Générales

### GANAN

Visita  
[www.LEGO.com/productfeedback](http://www.LEGO.com/productfeedback)

y envíanos tu opinión acerca de este  
set LEGO®. ¡Participarás en el sorteo  
de un premio LEGO!

Términos y Condiciones aplicables

### 获取奖品

登录  
[www.LEGO.com/productfeedback](http://www.LEGO.com/productfeedback)

给出关于此乐高®套装的简短反  
馈，就有机会获得炫酷乐高奖品

《条款及条件》适用



LEGO, the LEGO logo, DUPLO and the DUPLO logo are trademarks of the/son des marques de commerce du/son marcas registradas de LEGO Group.  
©2020 The LEGO Group. All rights reserved/Tous droits réservés/Todos los derechos reservados.  
BATMAN and all related characters and elements © & ™ DC Comics.  
WB SHIELD: © & ™ WBEI. (s20)

6321033