



Architecture

21044

Paris

France



Booklet available in English on
Heft in deutscher Sprache erhältlich auf
Livret disponible en français sur
Libretto disponibile in italiano su
Folleto disponible en español en
Folheto disponível em português em
A füzet magyarul ezen a honlapon olvasható
Buklets latviešu valodā pieejams vietnē
如需中文版手册, 请访问

LEGO.com/architecture



Paris, City of Lights

Paris, Ville lumière

Without a doubt, Paris deserves its reputation as one of the most beautiful and romantic cities in the world. Historically, it was a magnet for artists, writers and political dissidents and it remains the avant-garde in terms of art, fashion, gastronomy and culture. With its glorious boulevards full of bistros and boutiques, and its stunning UNESCO heritage-protected skyline, it is one of Europe's largest and most memorable cities. This LEGO® Architecture Paris skyline distills some of the city's most iconic monuments into a LEGO microscale keepsake. We hope that it evokes good memories and associations of this global city.

Paris mérite à coup sûr sa réputation d'être l'une des villes les plus belles et romantiques au monde. Autrefois, elle attirait les artistes, les écrivains et les dissidents politiques, mais elle conserve aujourd'hui son aura avant-gardiste dans les domaines de l'art, de la mode, de la gastronomie et de la culture. Avec ses majestueuses avenues bordées de bistros et de boutiques, et son époustouflant panorama urbain reconnu patrimoine protégé par l'UNESCO, cette ville est l'une des plus grandes et des plus remarquables d'Europe. Ce LEGO® Architecture Paris Skyline reprend quelques-uns des monuments les plus emblématiques de la ville pour en faire un souvenir miniature signé LEGO. Nous espérons qu'il vous rappellera de bons souvenirs de cette ville d'envergure internationale.

"A walk about Paris will provide lessons in history, beauty, and in the point of Life."

Thomas Jefferson

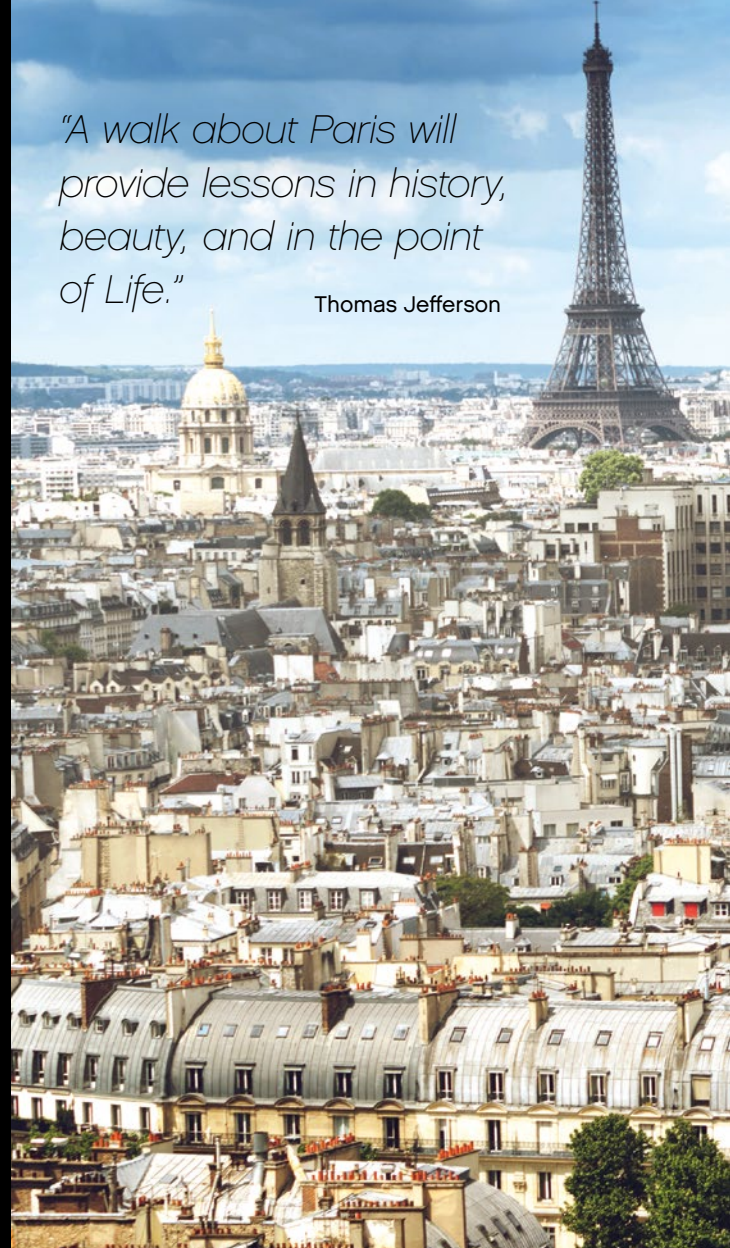

*« Une promenade dans Paris
vous donnera une leçon d'histoire
et de beauté ainsi que sur le
sens de la vie. »*

Thomas Jefferson



Arc de Triomphe

L'Arc de Triomphe

Think of Paris and the Arc de Triomphe will spring to mind as one of its most significant commemorative monuments. The beautiful neoclassical arch was ordered in 1806 by Napoleon and designed by the architect Jean Chalgrin to honor those who fought and died for France in the French Revolution and Napoleonic Wars. Since then, it has been the rallying point of French troops parading after successful military campaigns and the site of the annual Bastille Day Parade.

En pensant à Paris, l'Arc de Triomphe nous vient à l'esprit comme étant l'un de ses monuments commémoratifs les plus significatifs. Cet arc néoclassique magistral a été commandé en 1806 par Napoléon et conçu par l'architecte Jean Chalgrin en l'honneur des combattants et des morts pour la France lors de la Révolution française et des guerres napoléoniennes. Depuis lors, il est devenu le point de ralliement des troupes françaises qui défilent à l'occasion de victoires militaires, et accueille le traditionnel défilé du 14 juillet pour célébrer la fête nationale française.



Champs-Élysées

Les Champs-Élysées

One of the world's most beautiful and famous boulevards, the Champs-Élysées is synonymous with all that is glamorous and grand about Paris; luxury shops, cafes and theaters. Running almost 1.25 miles (2 kilometers) through the 8th arrondissement, it initially was an extension of the Tuilleries Gardens leading to the palace at Versailles, opened by Louis XIV in 1667, a date that many consider to be the birth of Paris as a grand city.

Comptant parmi les plus belles et plus célèbres avenues au monde, les Champs-Élysées sont synonymes de tout ce qui est glamour et prestigieux à Paris ; boutiques de luxe, cafés et théâtres. S'étendant sur près de 2 kilomètres dans le 8^e arrondissement, il s'agissait initialement d'une extension du jardin des Tuileries menant au Palais de Versailles, ouverte par Louis XIV en 1667, une date que beaucoup considèrent comme la naissance de Paris en tant que grande ville.





Tour Montparnasse

La tour Montparnasse

This 688.9 ft. (210m) monolithic skyscraper is located in the Montparnasse area of Paris. Designed by the architects Eugène Beaudouin, Urbain Cassan, and Louis de Hoÿm de Marien, it was built by Campenon Bernard. It was the tallest tower until 2011 when the Tour First surpassed it. Loved and hated, it is often criticized for being out of place in the Paris skyline but offers unique panoramic views of the city's famous attractions.

Ce gratte-ciel monolithique de 210 mètres de haut est situé dans le quartier de Montparnasse à Paris. Conçue par les architectes Eugène Beaudouin, Urbain Cassan et Louis de Hoÿm de Marien, la tour fut construite par l'entreprise Campenon Bernard. Elle est restée la plus haute tour de Paris jusqu'en 2011, l'année d'achèvement des travaux de la tour First, devenue plus haute qu'elle. Adulée et détestée à la fois, elle est souvent critiquée pour détonner dans le panorama parisien, mais elle a le mérite d'offrir une vue panoramique unique sur les plus célèbres pôles d'attractions de la ville.



Grand Palais Le Grand Palais

The Grand Palais des Champs-Élysées was built in 1897 in preparation for the Universal Exposition of 1900 and is now a historical site, exhibition hall and museum complex. Its original purpose was to be the home of great artistic events in the city of Paris. Since its inauguration, this ornate building with its spectacular glass roof has seen a parade of art and cultural shows of all types.

Le Grand Palais des Champs-Élysées a été érigé en 1897 en vue de l'Exposition universelle de 1900. Il est aujourd'hui devenu un site historique, et abrite un hall d'exposition ainsi qu'un complexe muséal. Son objectif initial était d'accueillir de grands événements artistiques dans la ville de Paris. Depuis son inauguration, ce bâtiment surmonté d'une immense verrière a vu défiler des manifestations artistiques et culturelles en tous genres.



Eiffel Tower

La tour Eiffel

Nothing represents Paris more than the iconic Tour Eiffel, or Eiffel Tower. Built between 1887-1889, it is named after the engineer Gustav Eiffel, who designed and built the wrought iron structure.

The actual design of the tower was by Maurice Koechlin and Émile Nougier, who worked for Eiffel at the time, together with architect Stephen Sauvestre, and was inspired by the Latting Observatory in New York.

This much-loved global cultural icon of Paris was not, however, so popular on its inception; it was much maligned by leading artists and intellectuals of the time. Today, however, it is considered to be a magnificent example of structural art.

Rien ne symbolise mieux Paris que son emblématique tour Eiffel. Construite entre 1887 et 1889, elle porte le nom de l'ingénieur Gustave Eiffel, réputé être à l'origine de la conception et de la construction de sa structure en fer forgé.

Mais en réalité, la tour a été conçue par Maurice Koechlin et Émile Nougier, qui travaillaient pour Eiffel à l'époque, en collaboration avec l'architecte Stephen Sauvestre. Elle s'inspirait de l'Observatoire de Latting à New York.

Cette icône parisienne culturelle d'envergure mondiale très appréciée n'était cependant pas si populaire au moment de sa création ; elle était très décriée par les grands artistes et intellectuels de l'époque. Toutefois, aujourd'hui, elle est considérée comme un magnifique exemple d'art structurel.

Musée du Louvre

The Musée du Louvre opened in 1793, during the French Revolution, and from the very beginning was intended to provide inspiration for contemporary art. As a former royal residence, the Louvre is inextricably linked to eight centuries of French history. Over 35,000 artworks are displayed, including universally admired works such as the Mona Lisa by Leonardo da Vinci, the Winged Victory of Samothrace and the Venus de Milo.

Ouvert en 1793 pendant la Révolution française, le musée du Louvre a, dès ses débuts, eu pour ambition d'être une source d'inspiration pour les artistes contemporains. Ancienne résidence royale, le musée du Louvre est intimement lié à huit siècles d'histoire de France. Plus de 35 000 œuvres d'art y sont exposées, dont des chefs-d'œuvre universellement admirés comme la Joconde de Léonard de Vinci, la Victoire de Samothrace et la Vénus de Milo.



1



2



3

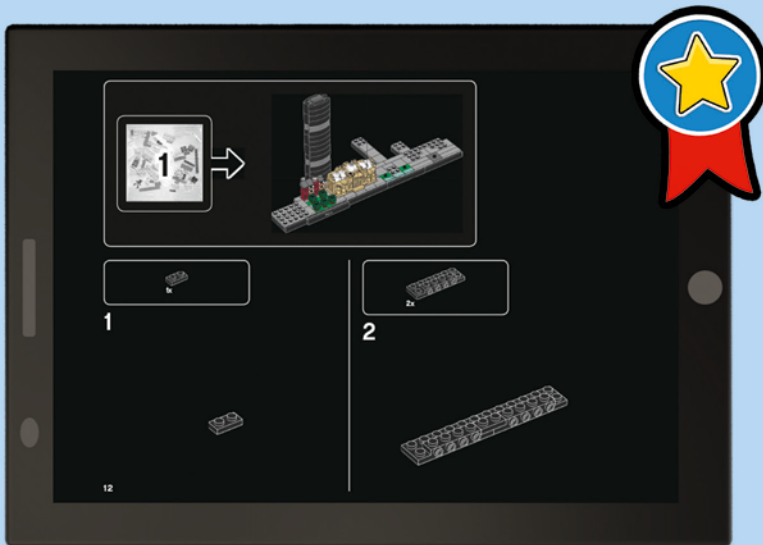

LEGO.com/apps

- Check for compatibility
- Kompatibilität prüfen
- Vérifier la compatibilité
- Controlla la compatibilità
- Comprueba tu compatibilidad
- Verificar a compatibilidade
- Ellenőrizd a kompatibilitást
- Pārbaudīt saderību
- 检查兼容性

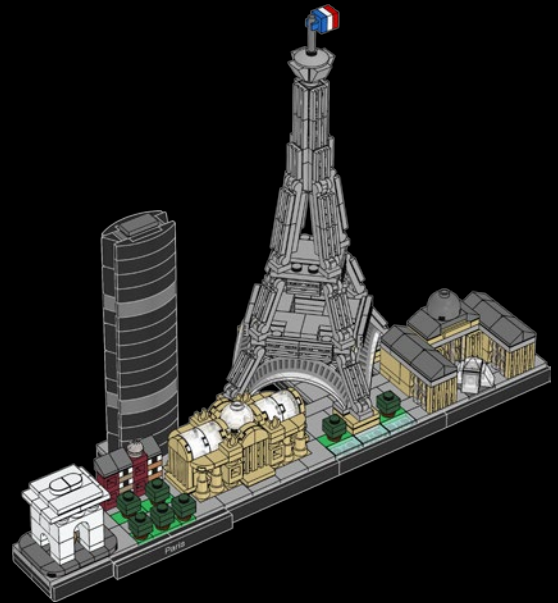
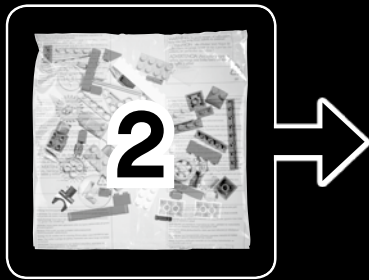
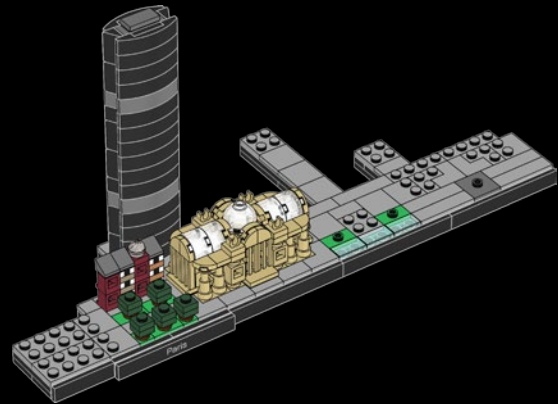
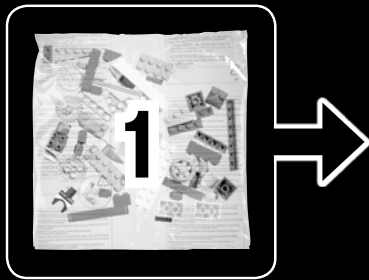

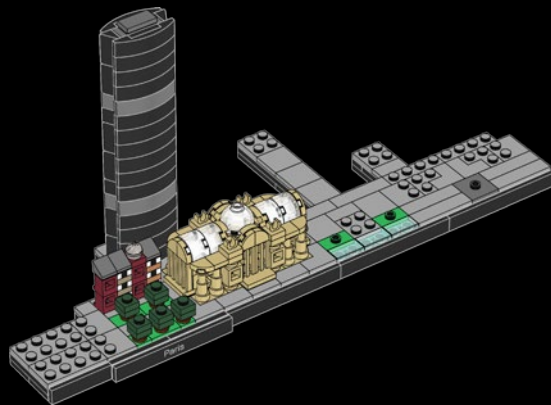

1x

1

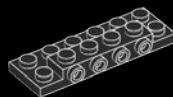
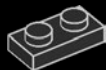

2x

2

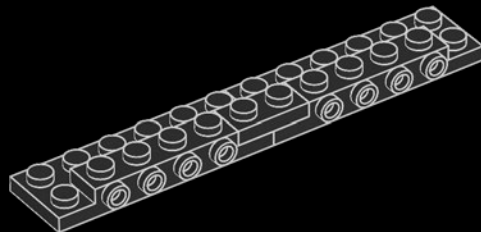



3

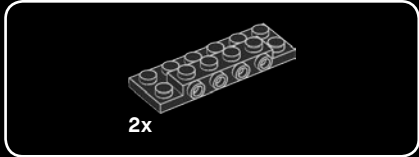
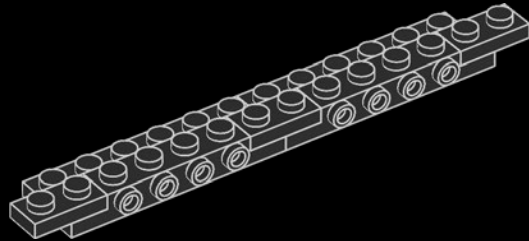

4

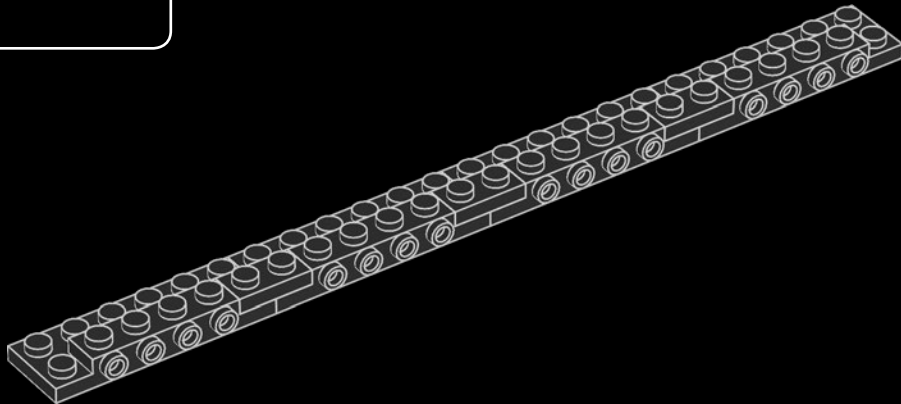



2x

5

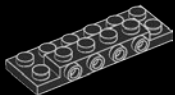
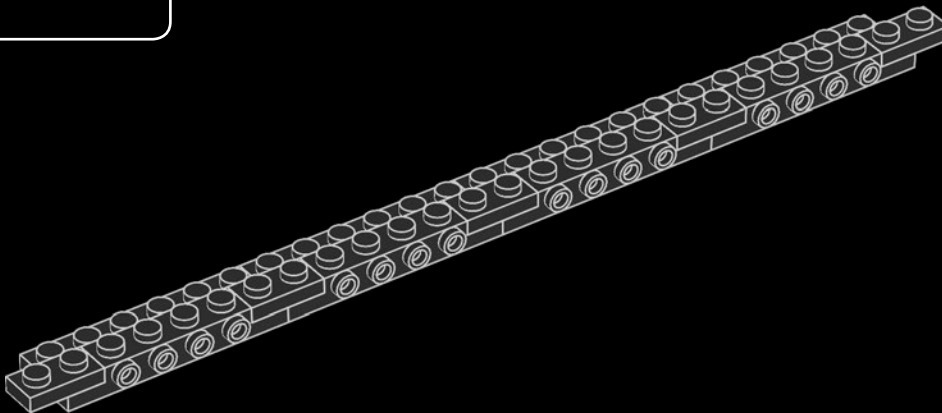

2x

6

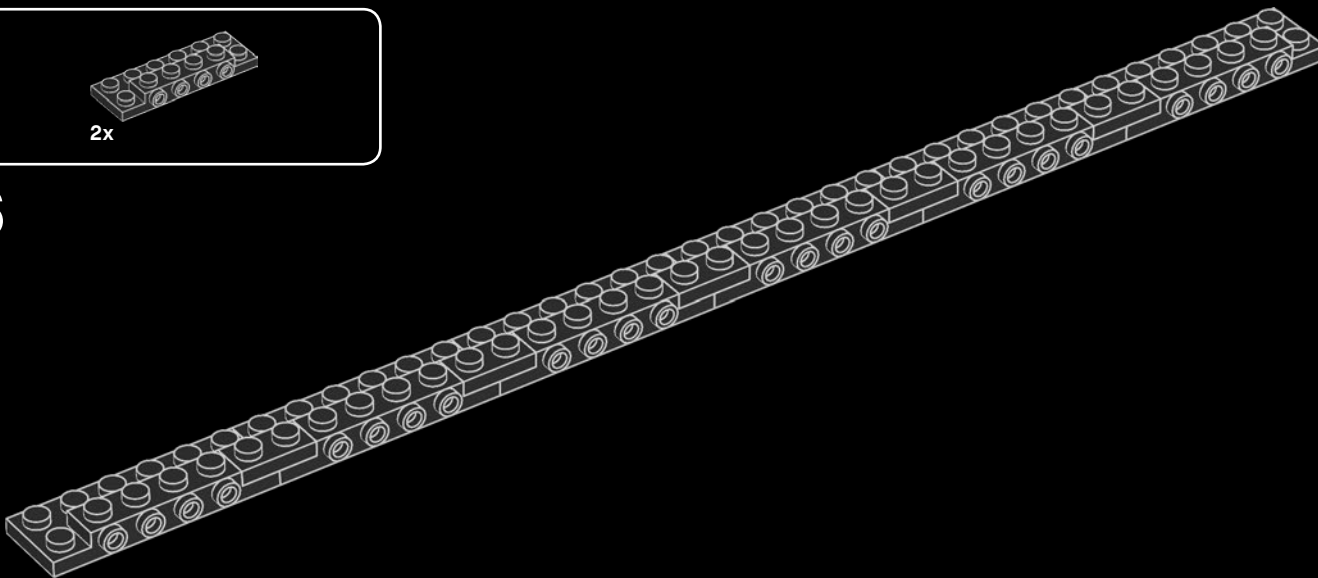

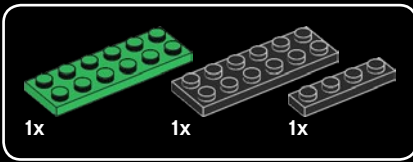

7

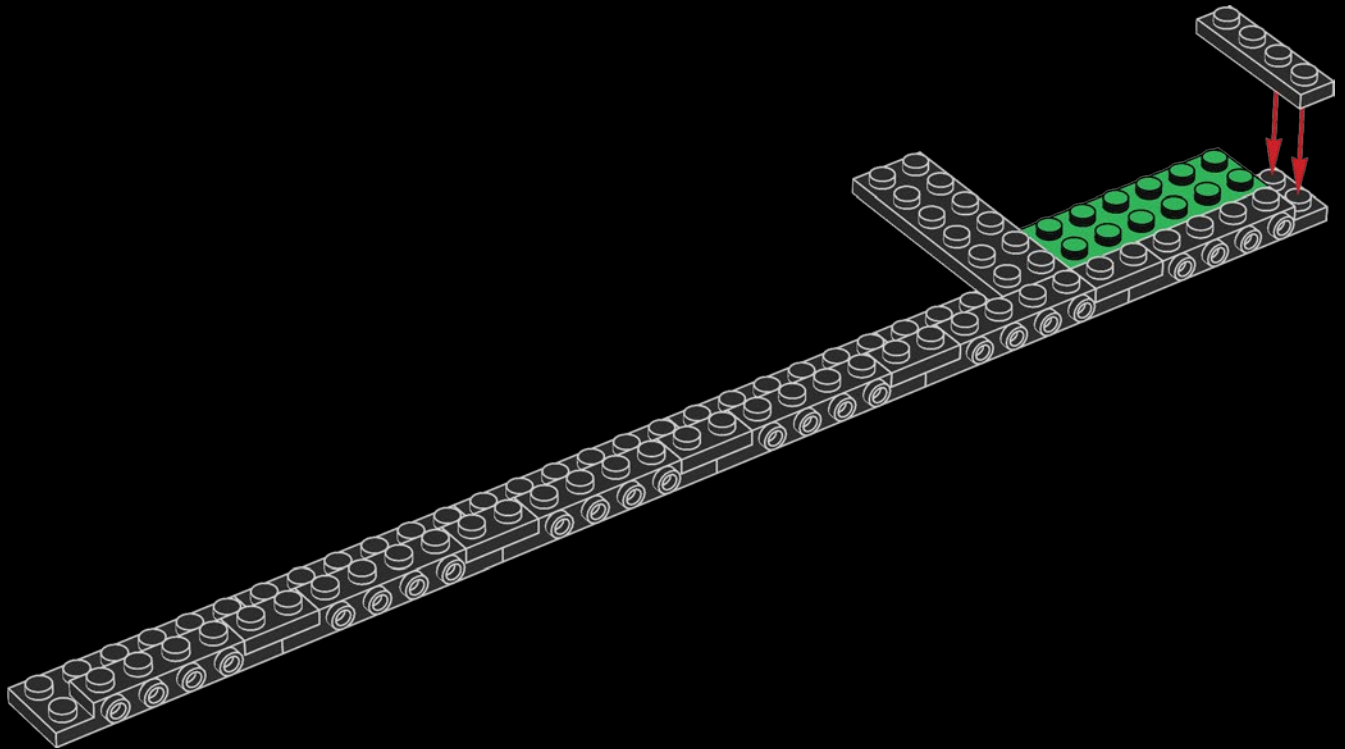

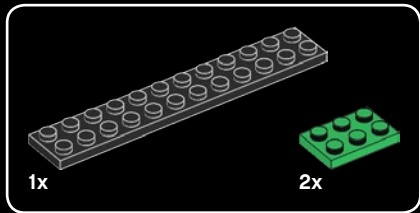

8

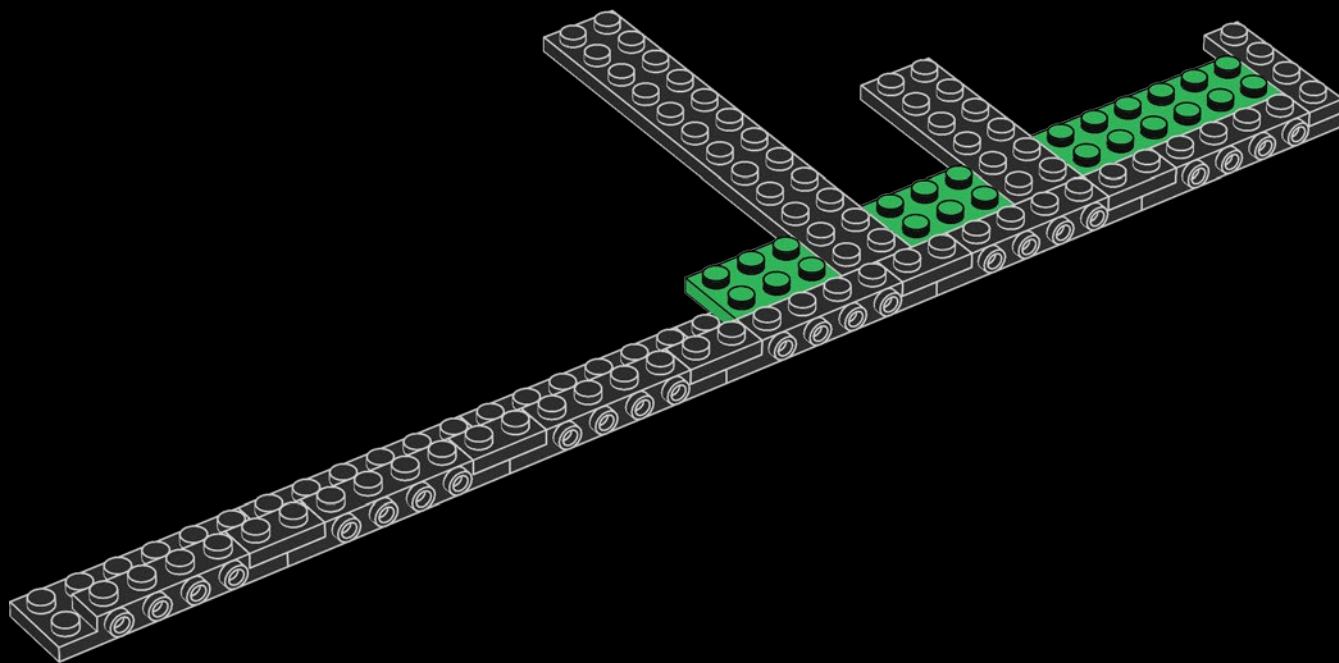

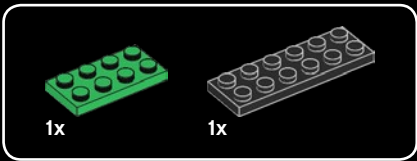

9

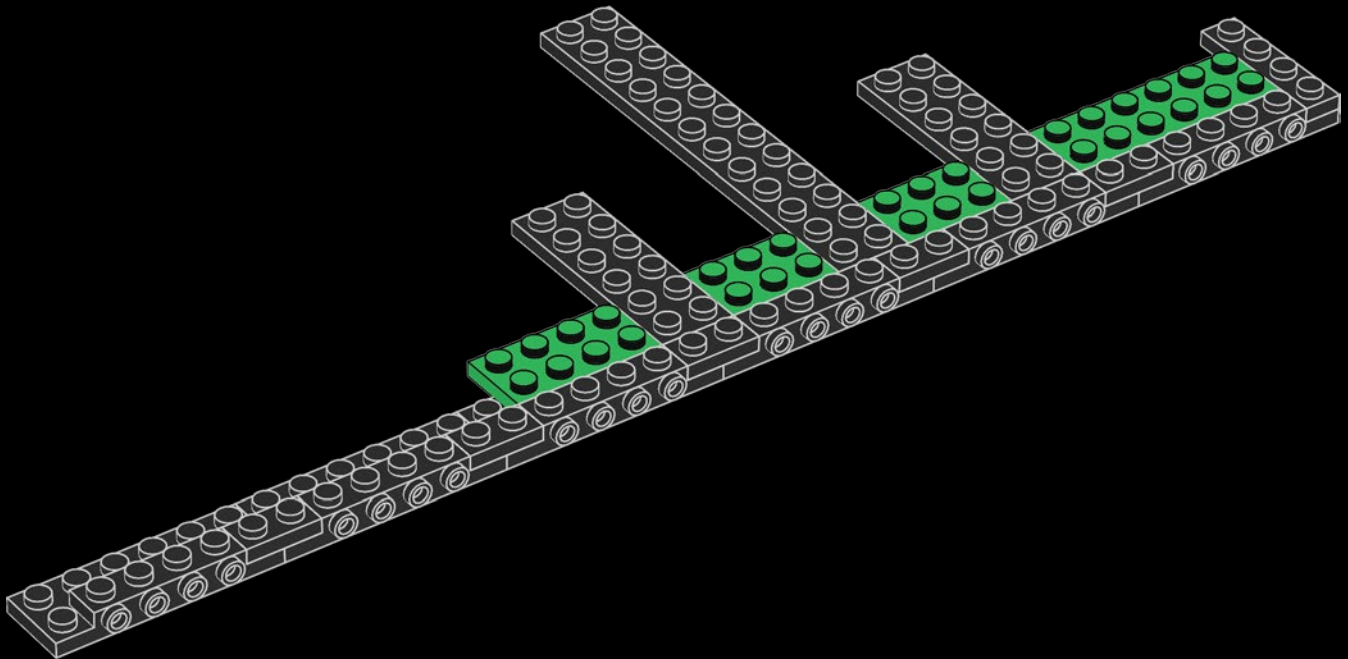

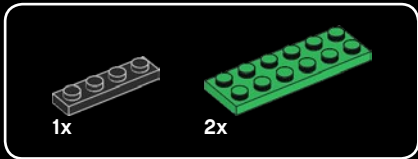

10

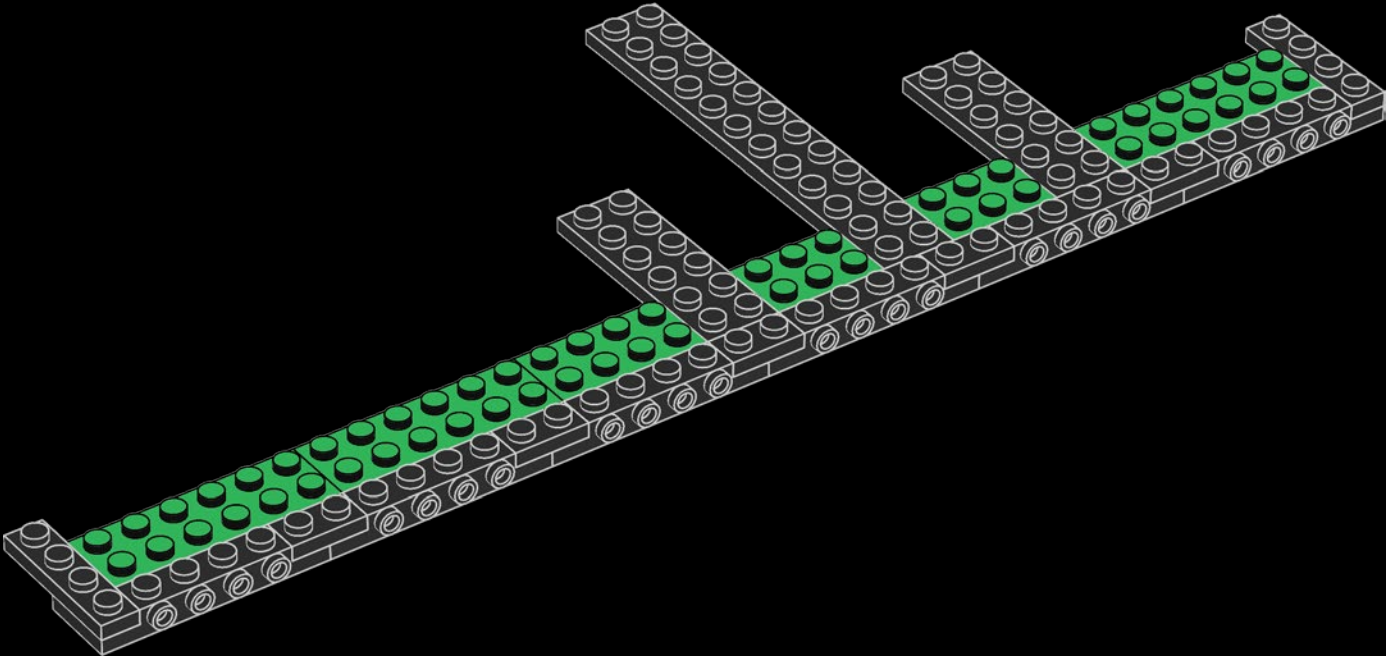

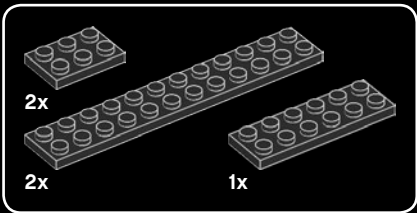

11

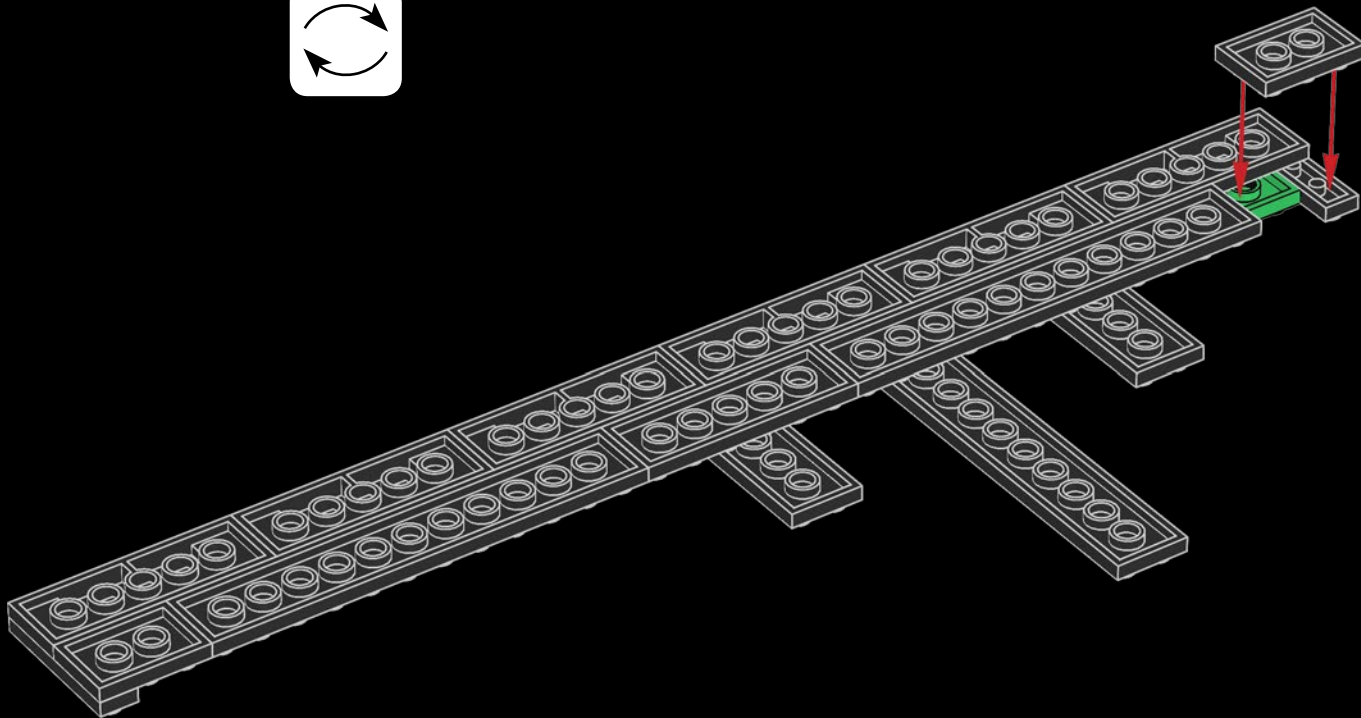

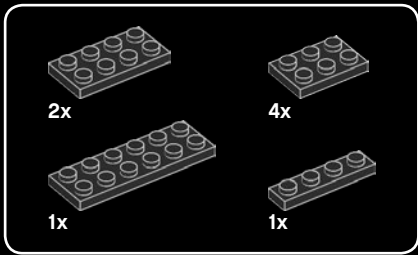

12

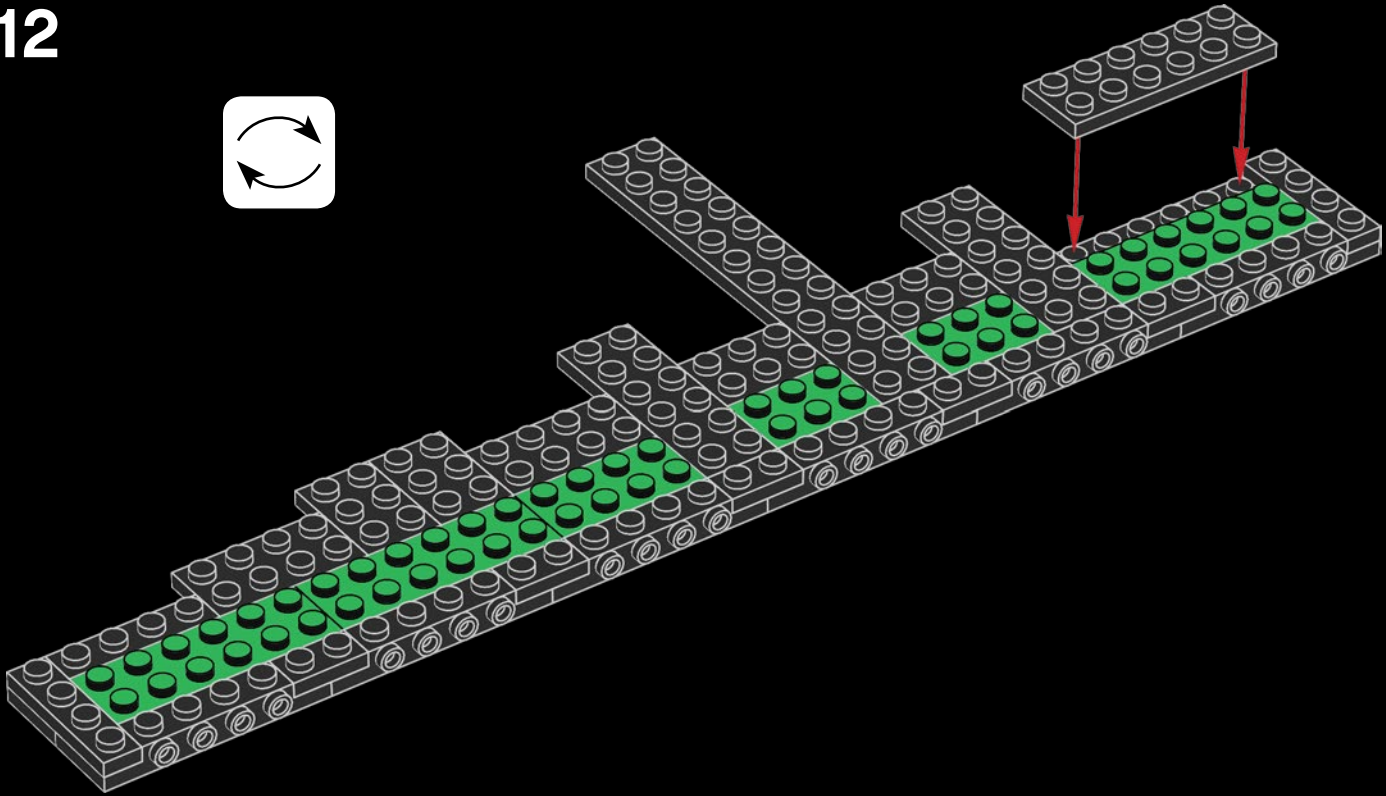

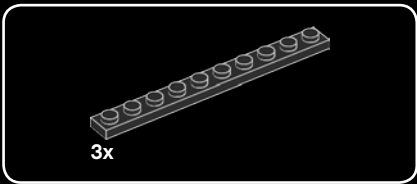

13

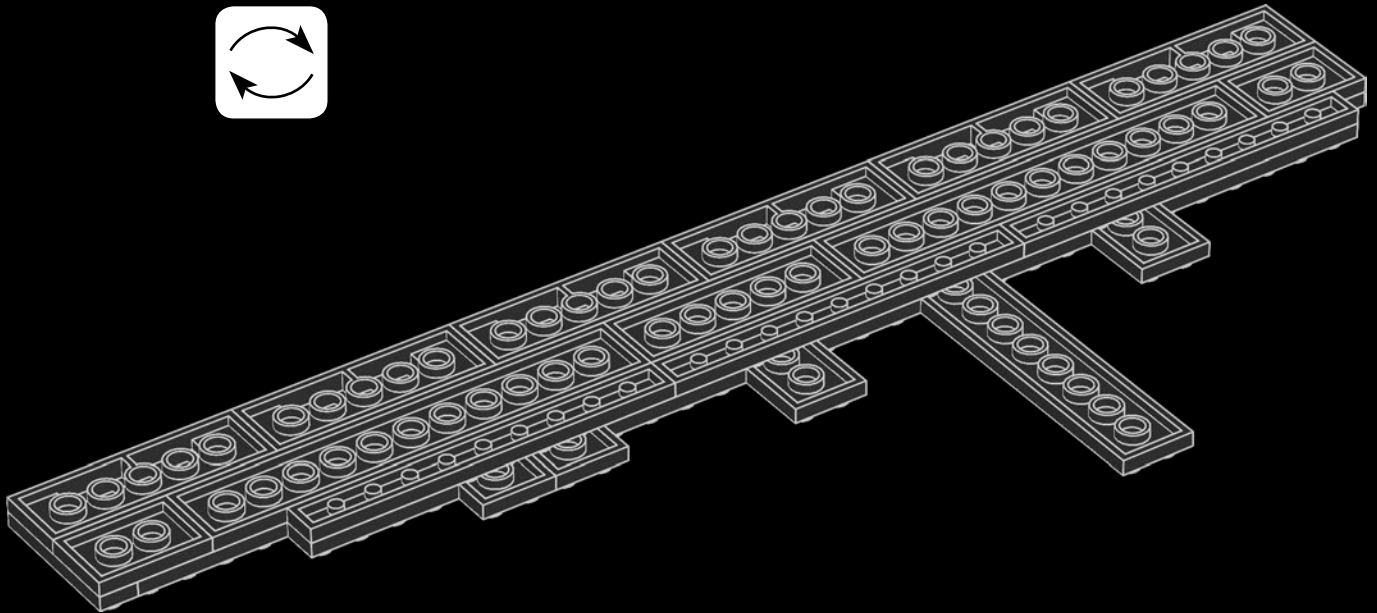
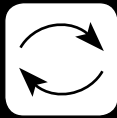

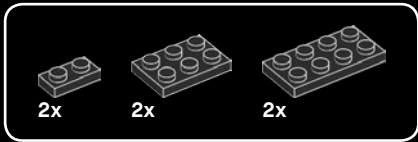

14

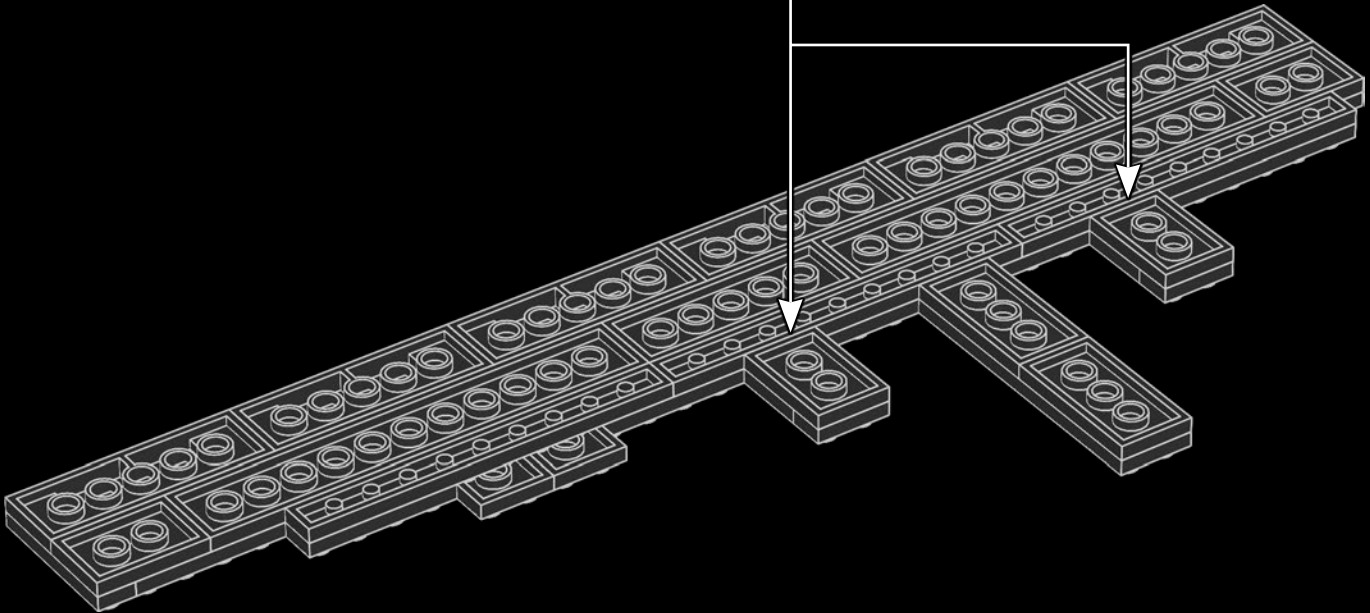
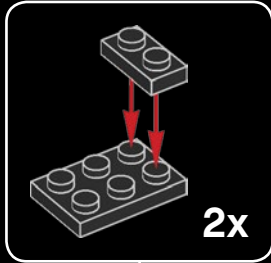

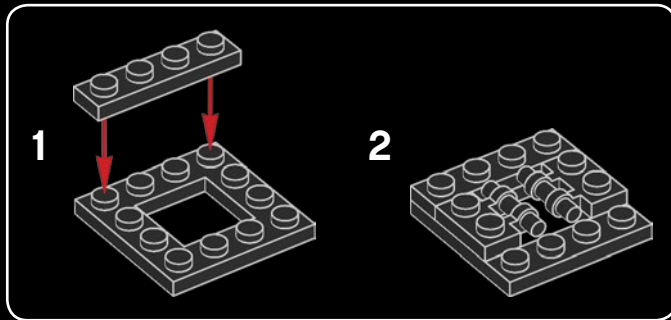
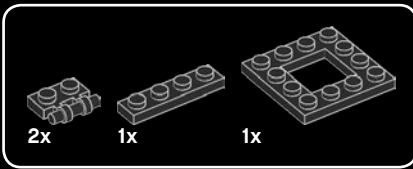

15

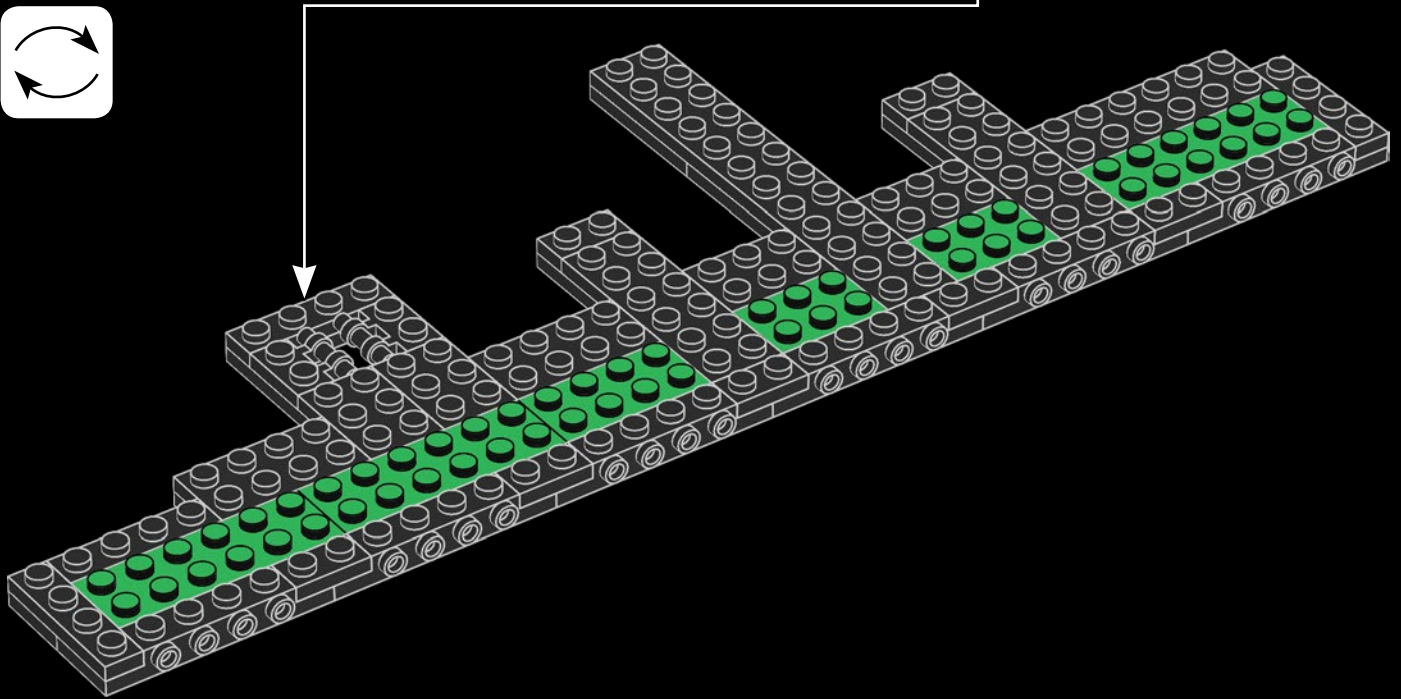

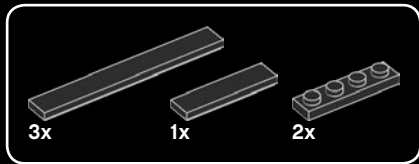

16

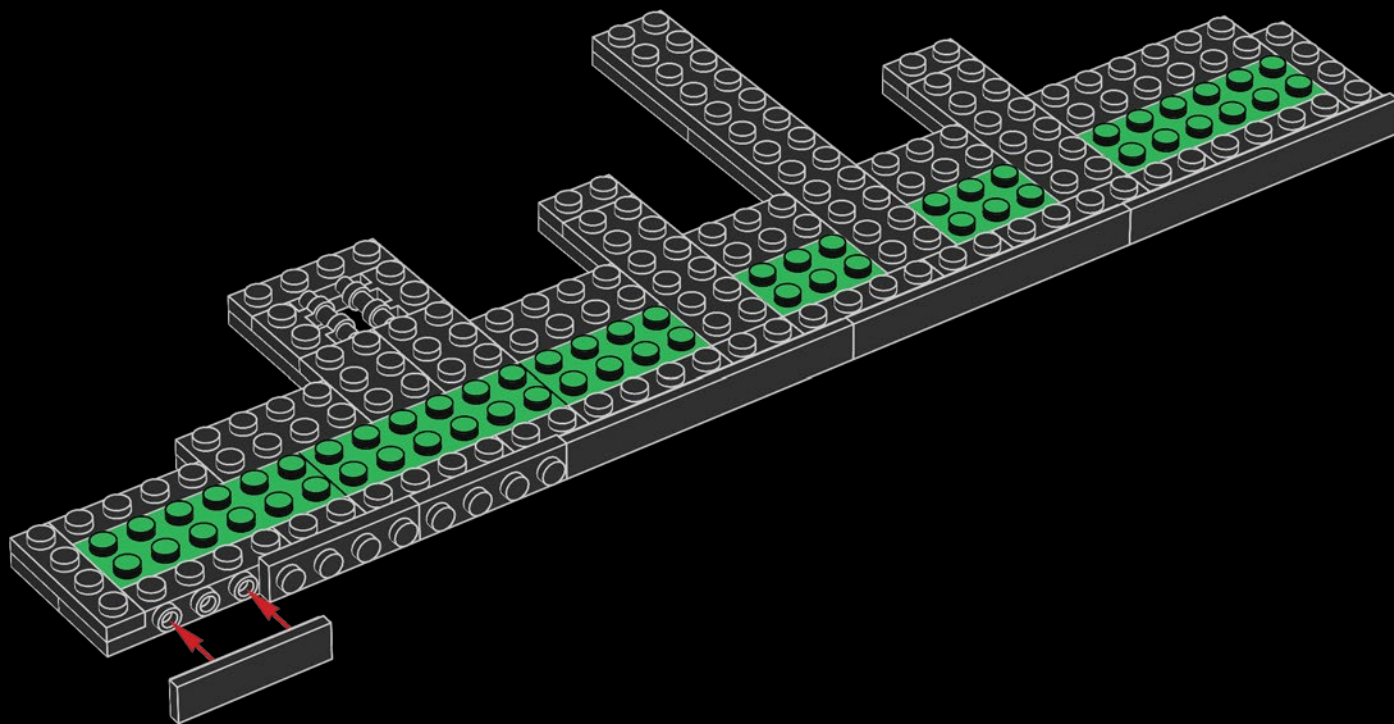

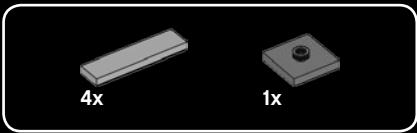

17

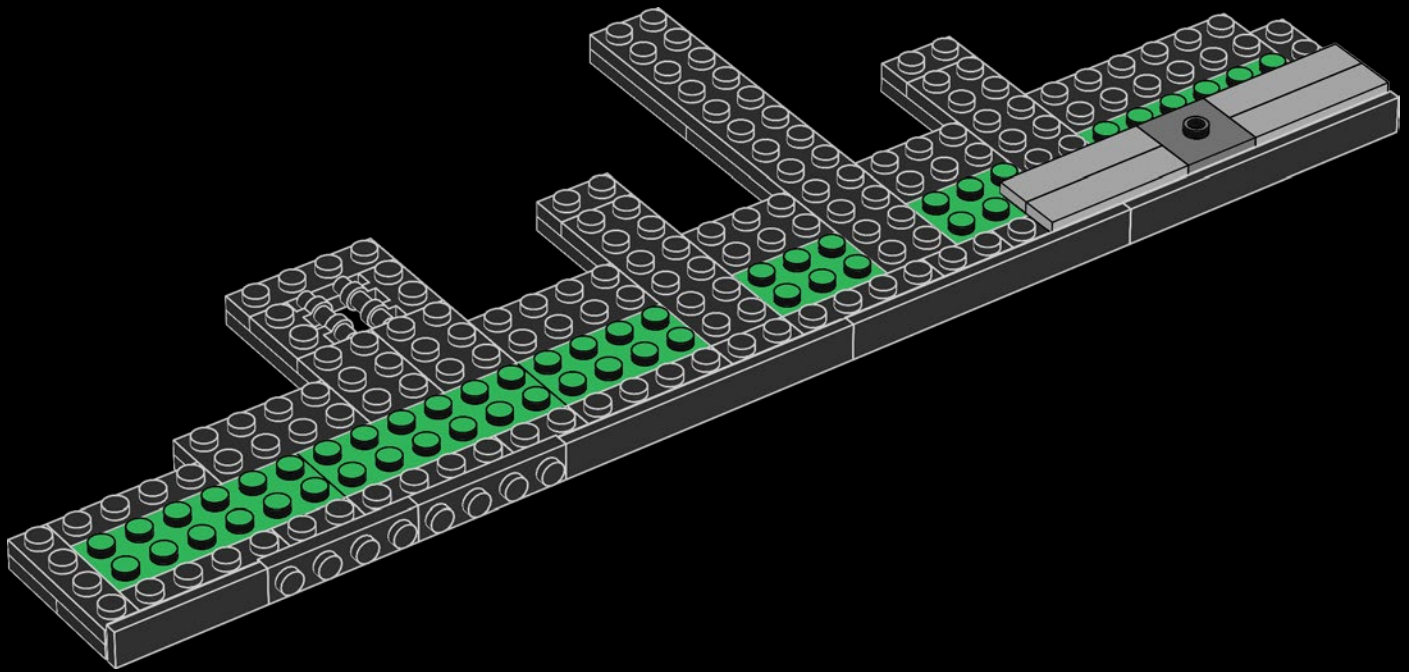

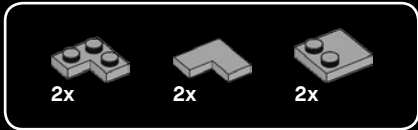

18

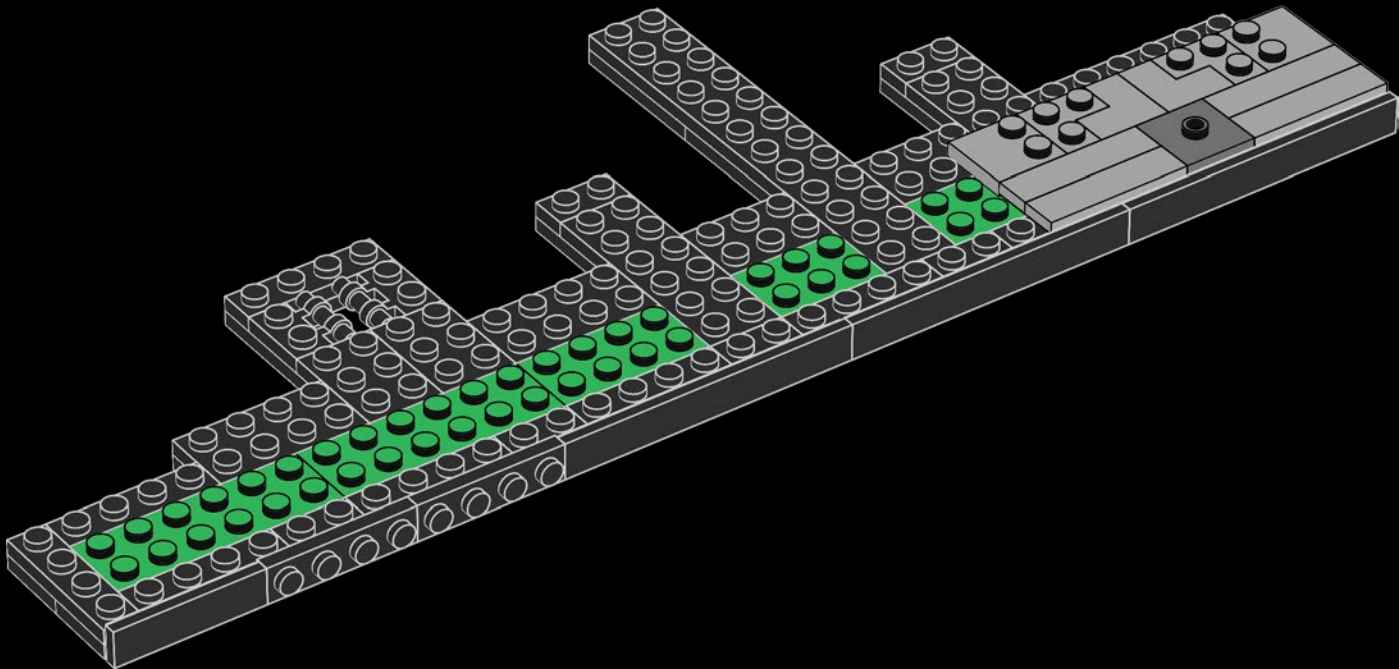

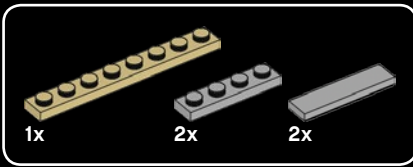

19

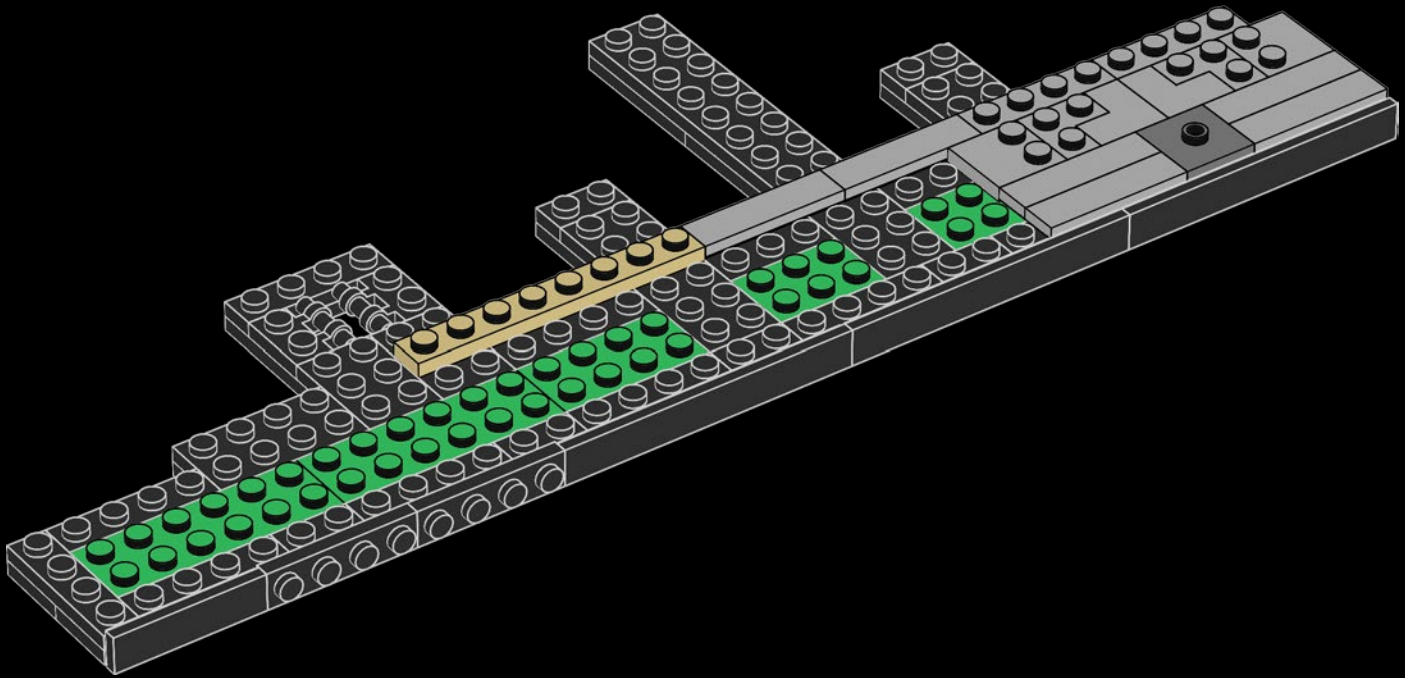

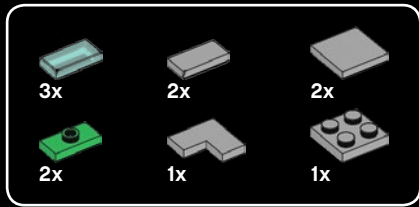

20

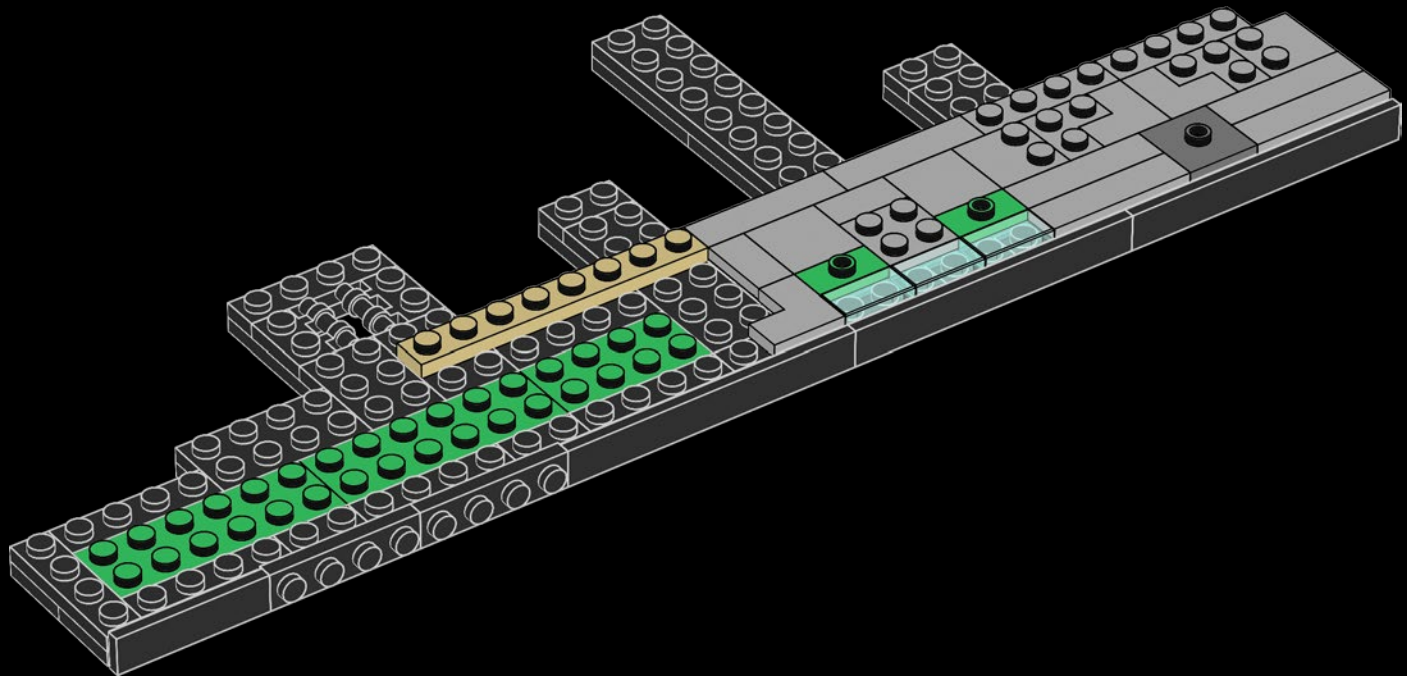

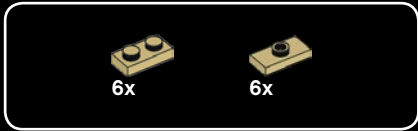

22

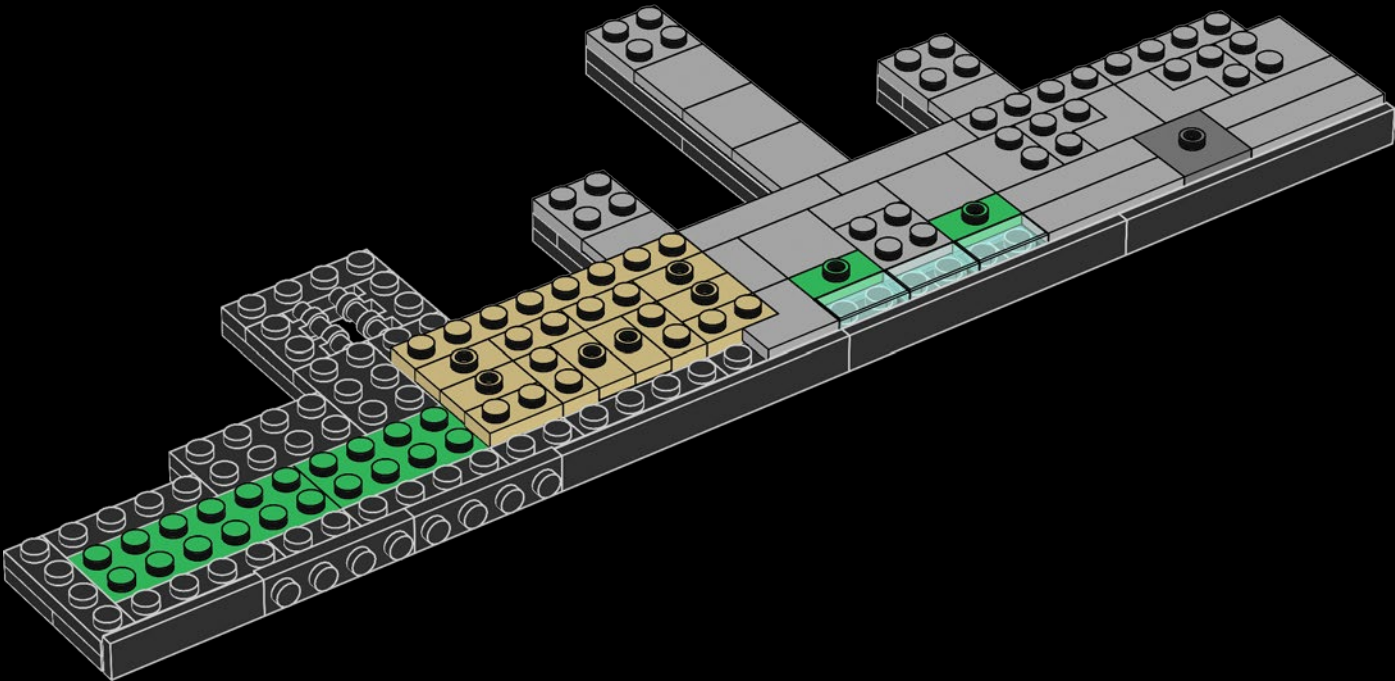



4x

24

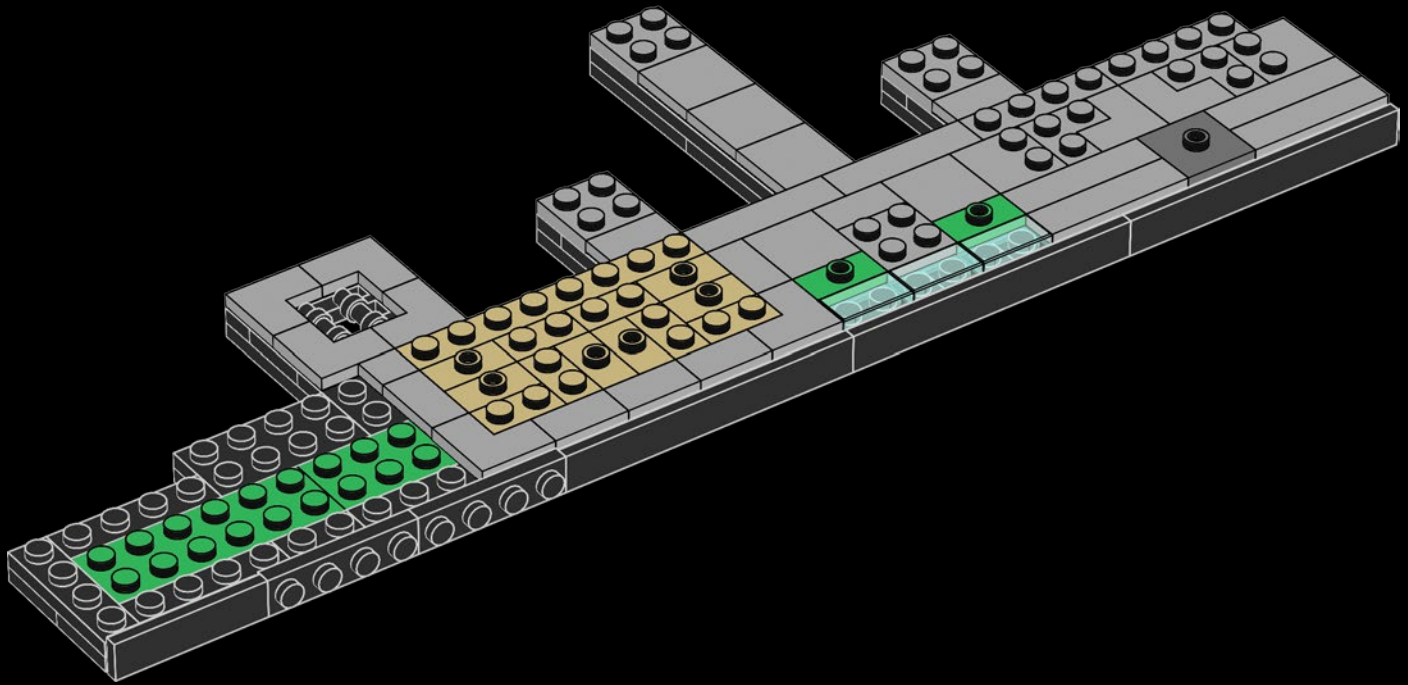

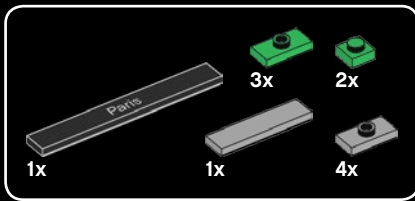

25

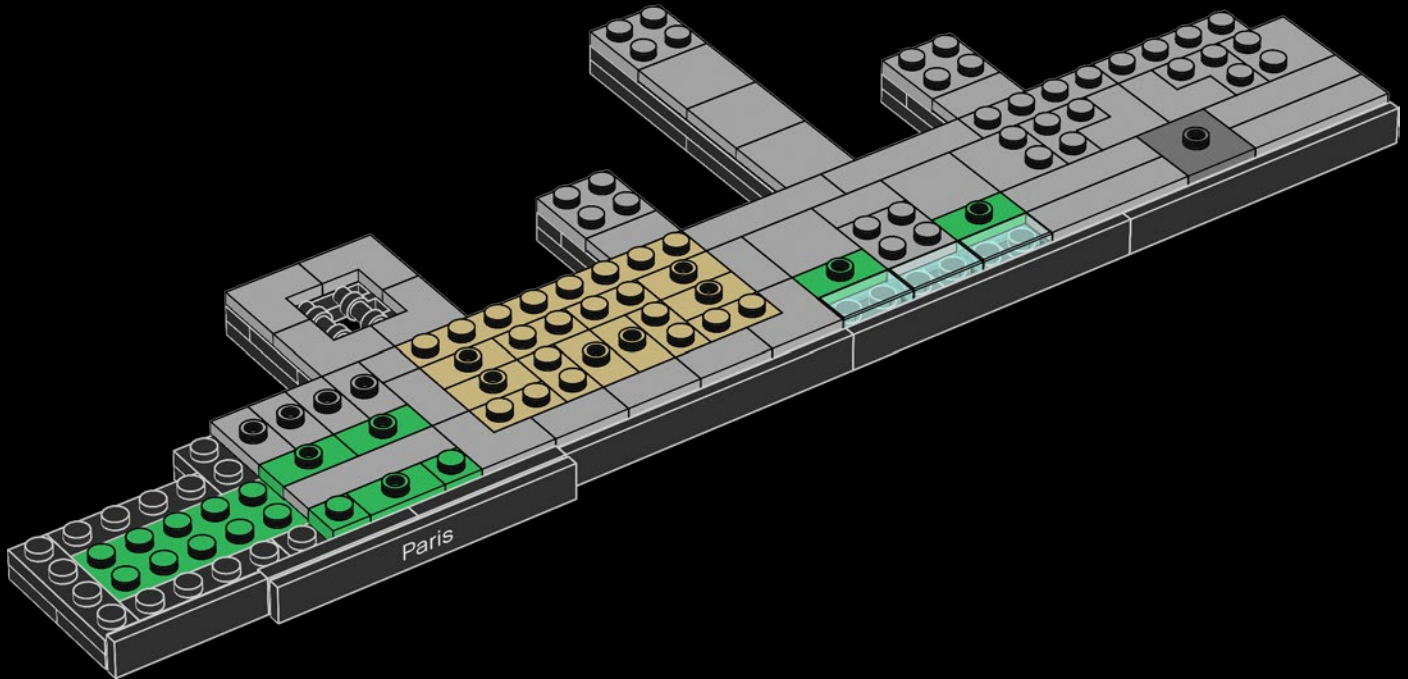

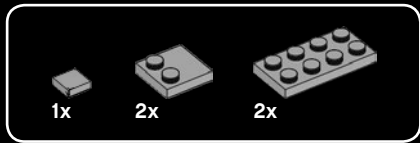

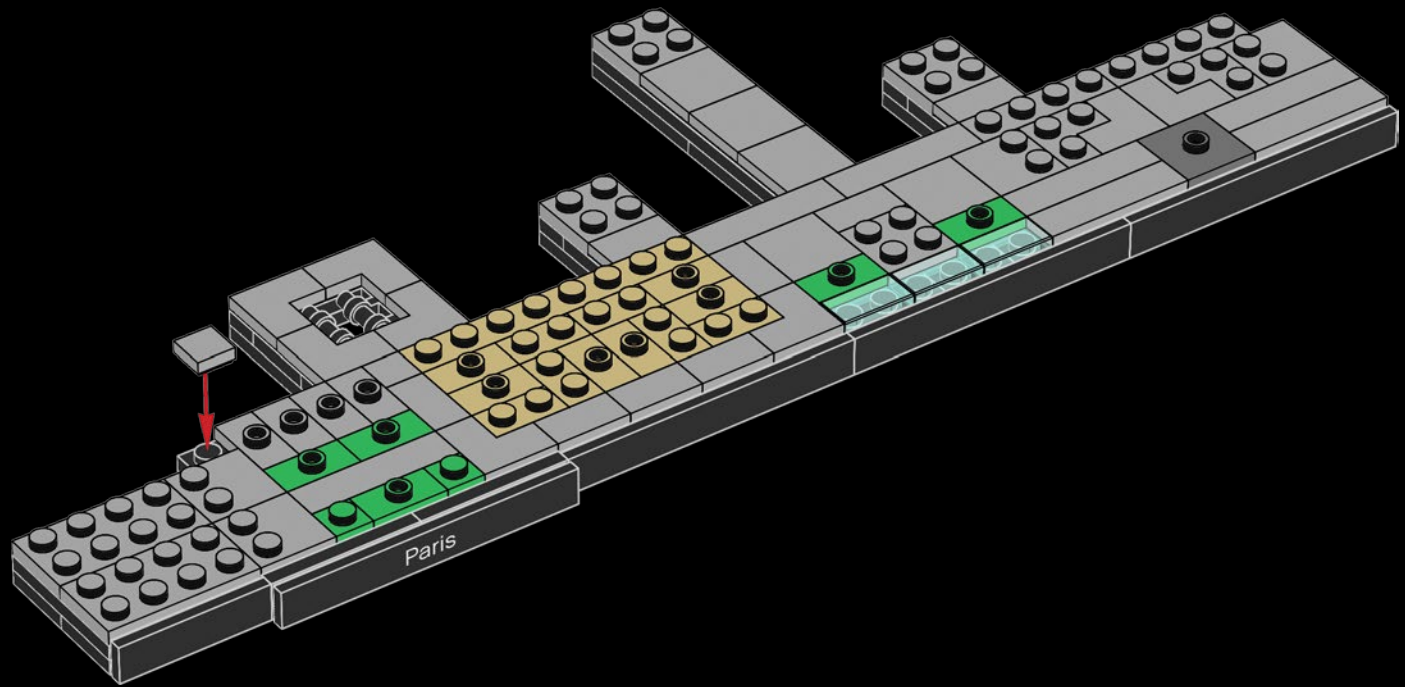

26



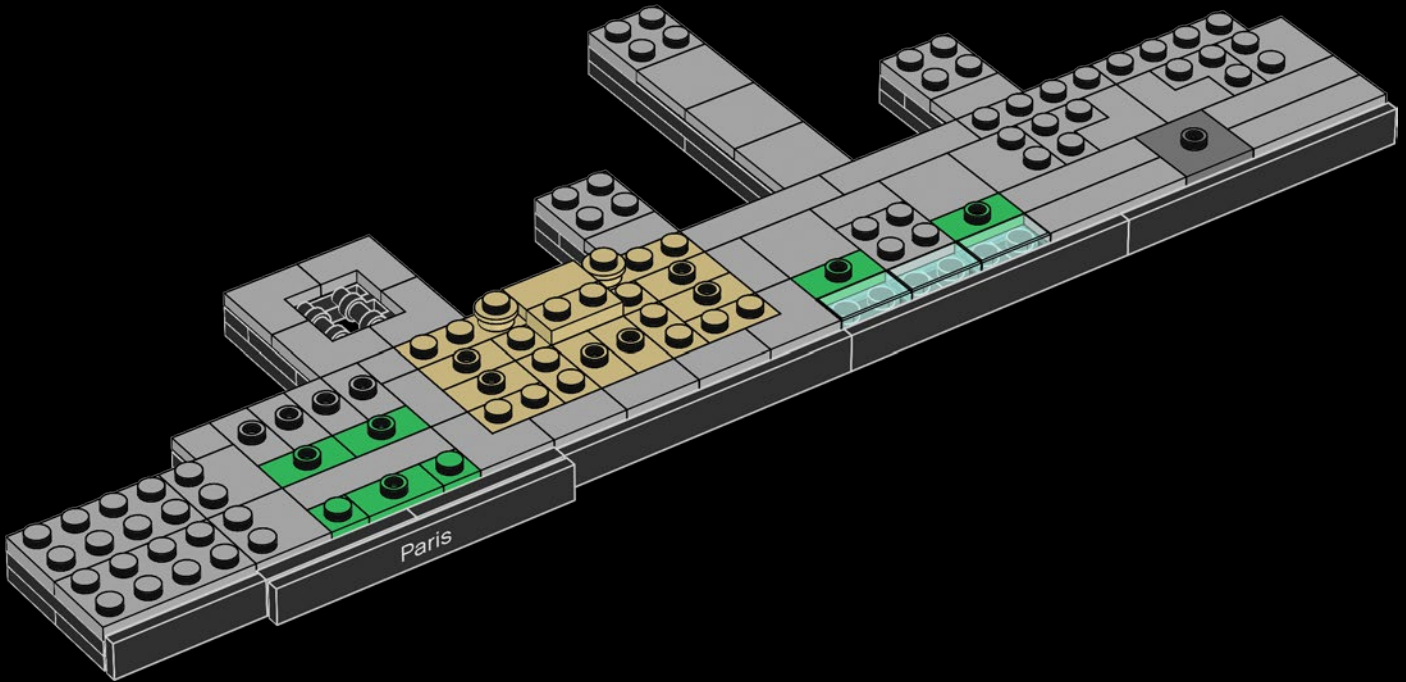

27



2x  3x 

28

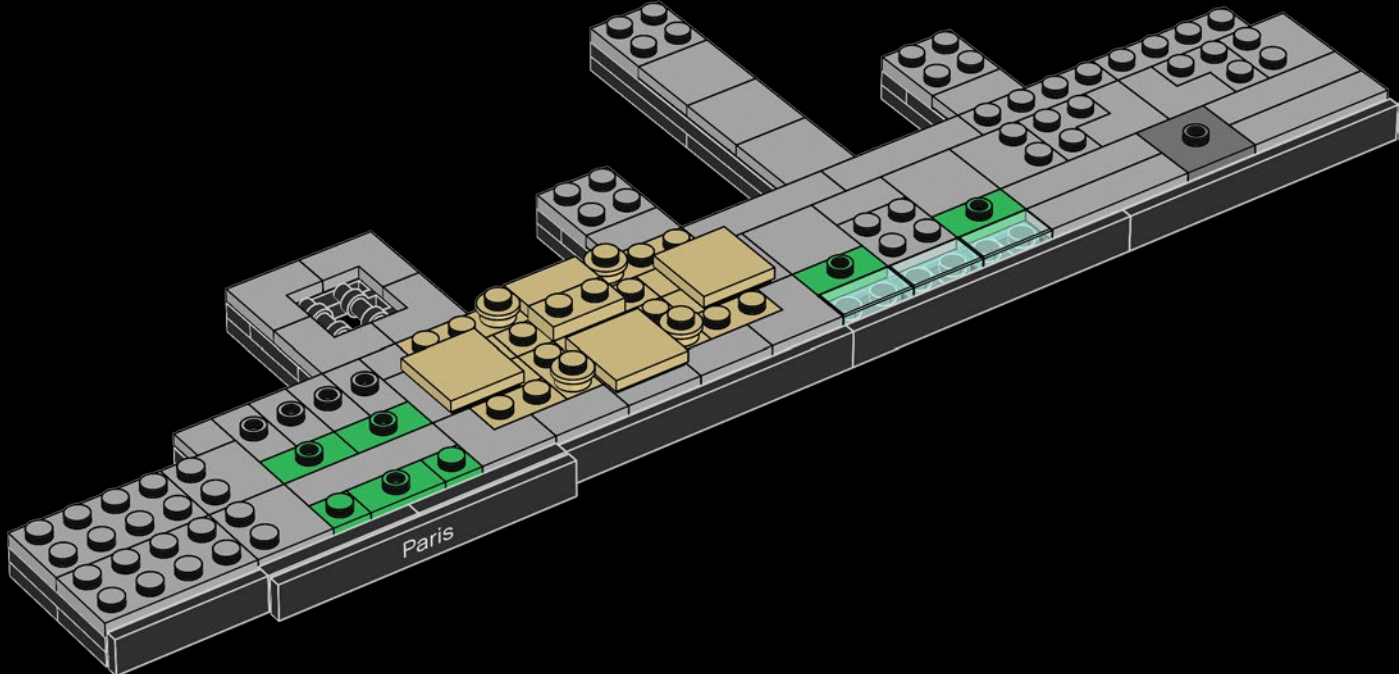



29

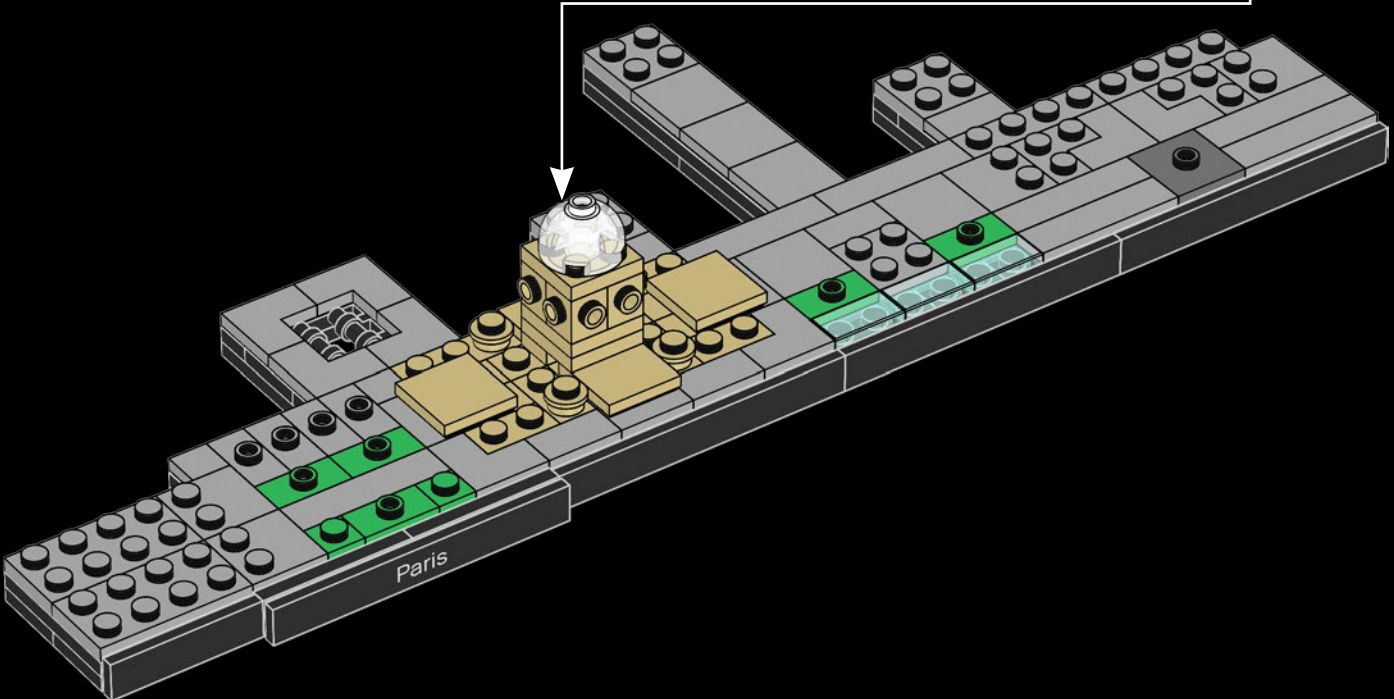
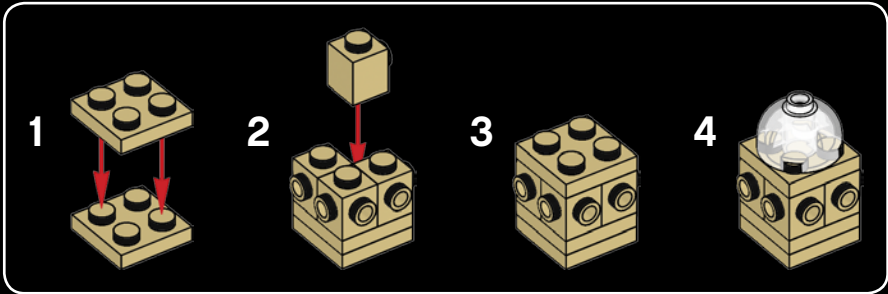



30

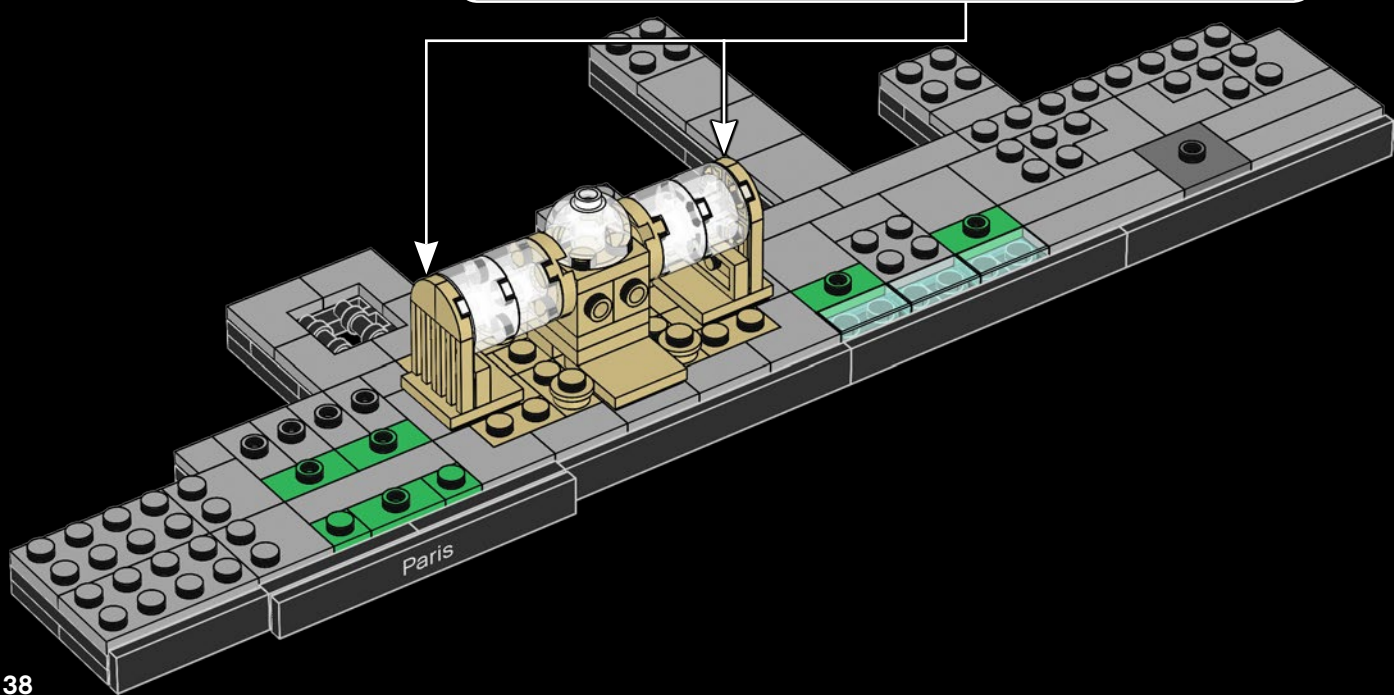
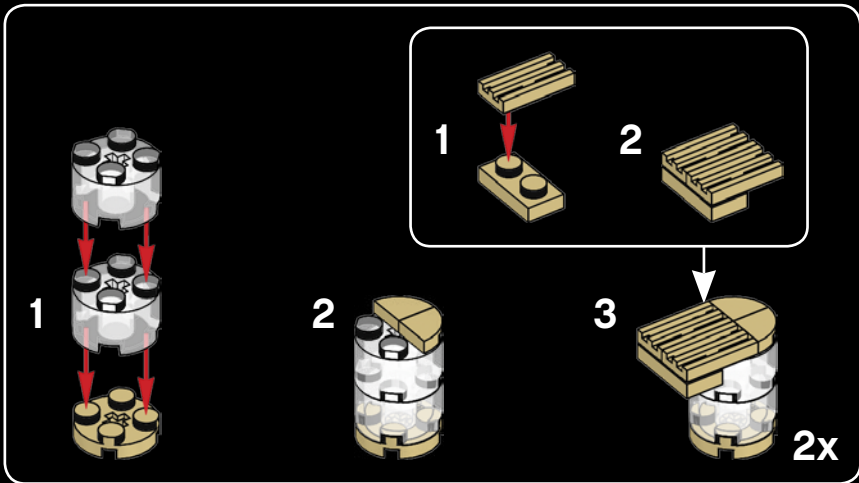



31

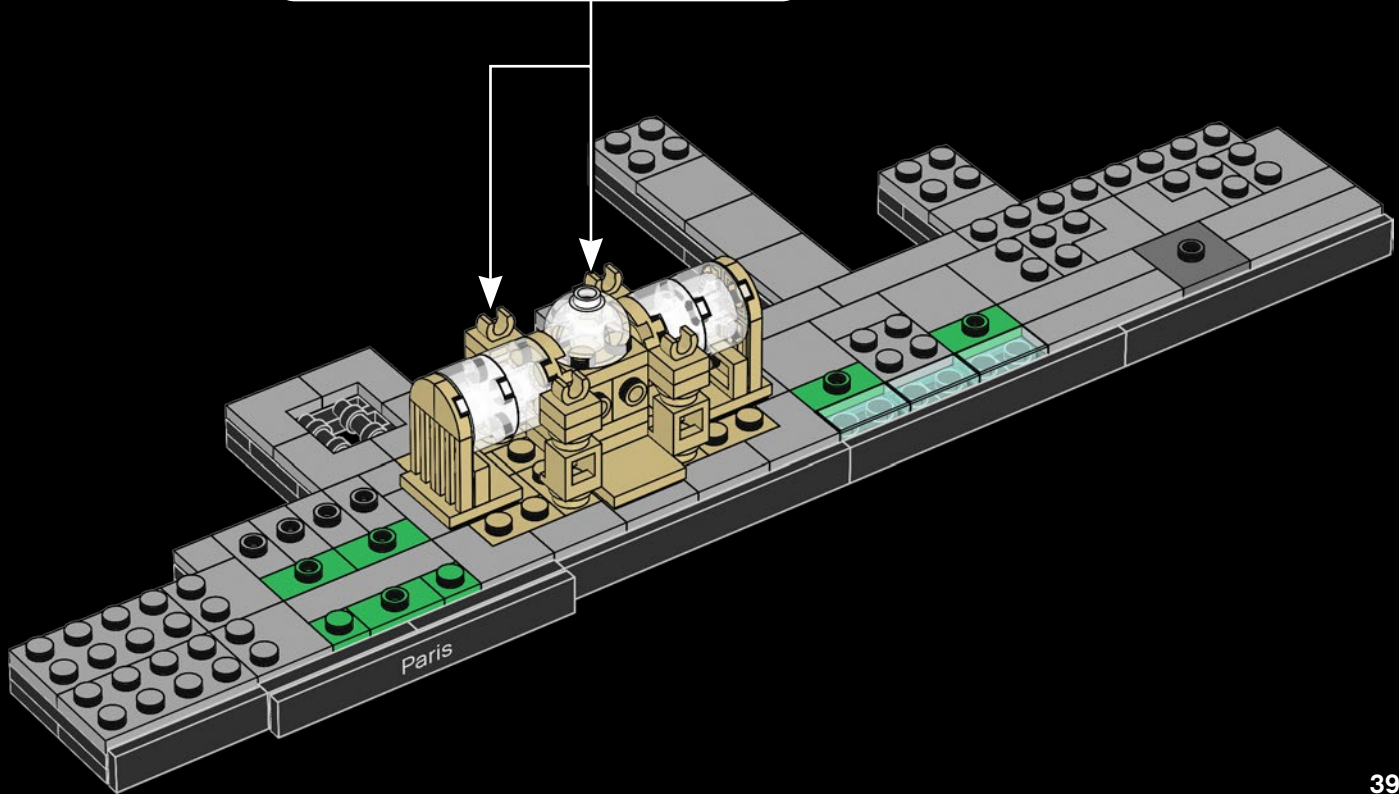
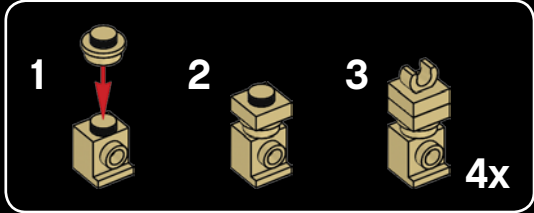



32

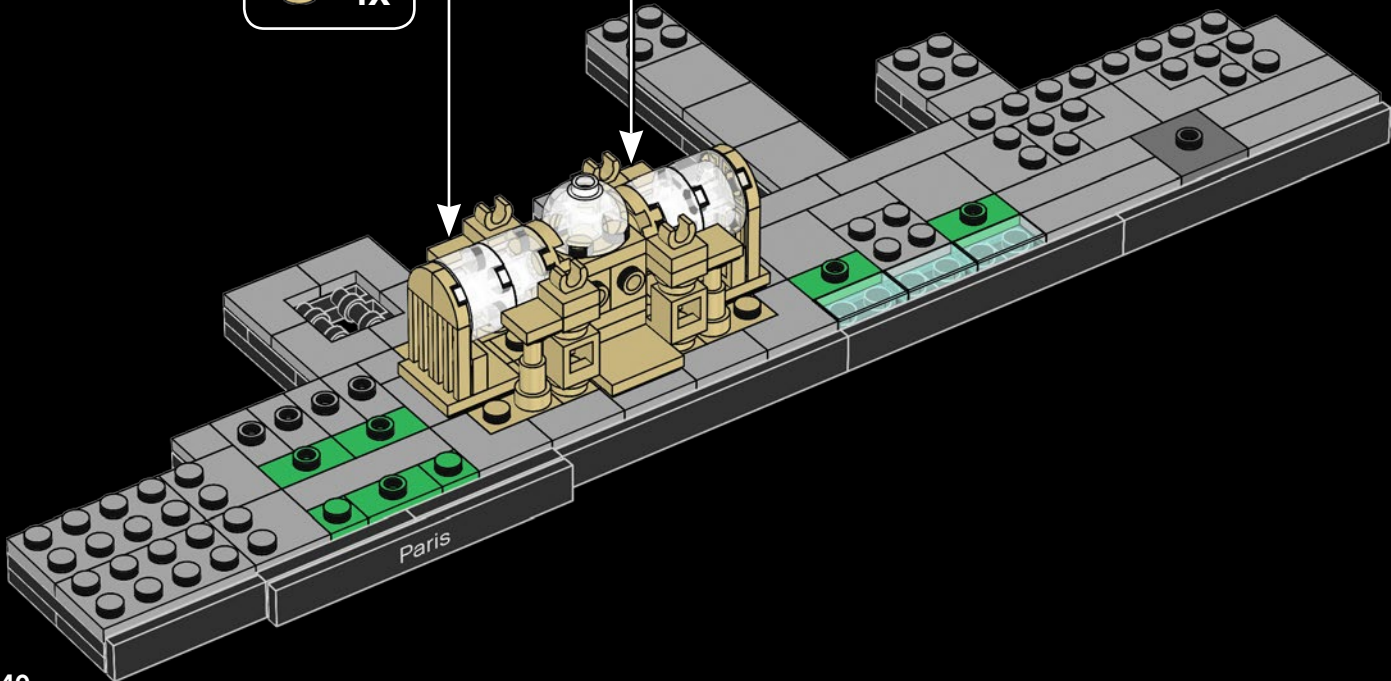
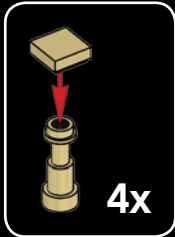



33

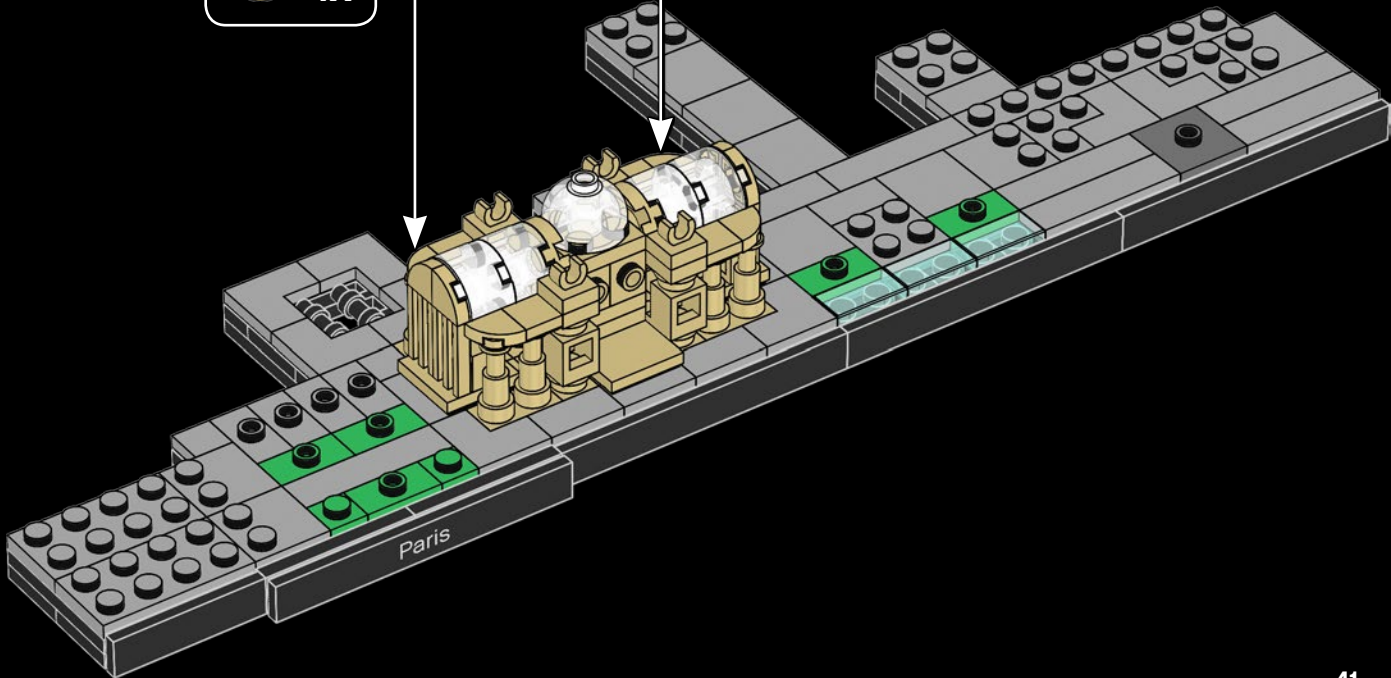
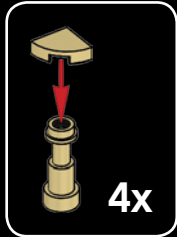

Delicate but strong
The Grand Palais is the largest existing ironwork and glass structure in the world.

Délicat mais résistant
Le Grand Palais est le plus grand ouvrage de ferronnerie et de structure en verre existant au monde.



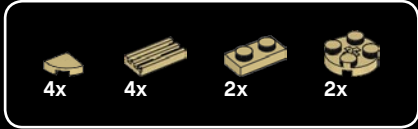

34

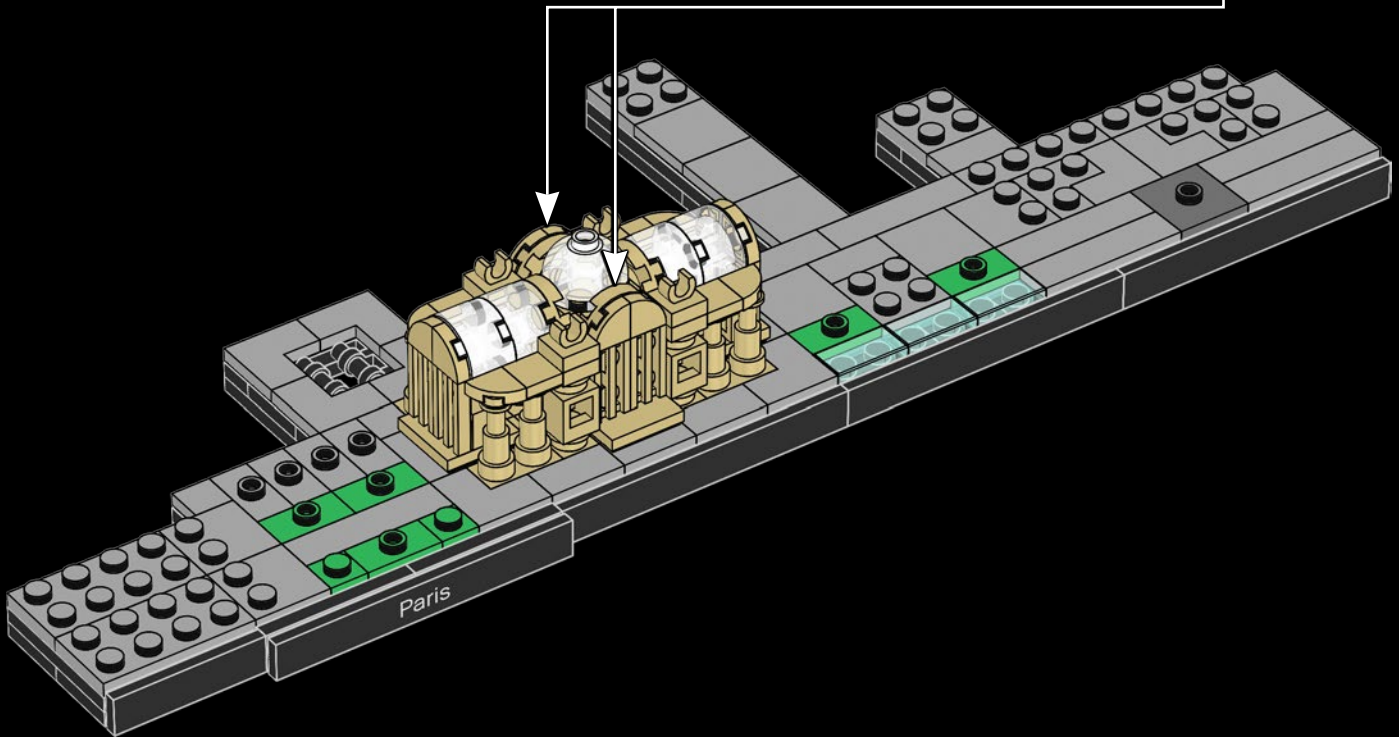
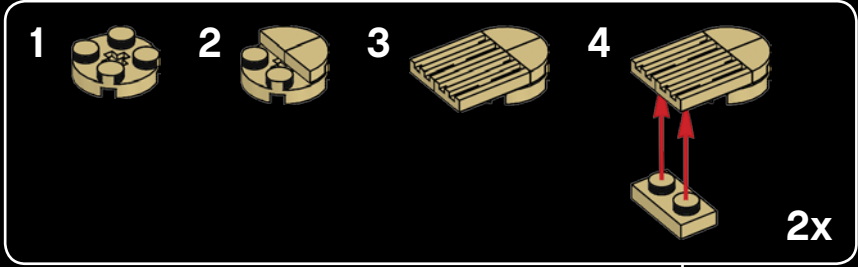

-  1x
-  1x
-  3x
-  3x
-  1x
-  2x

35

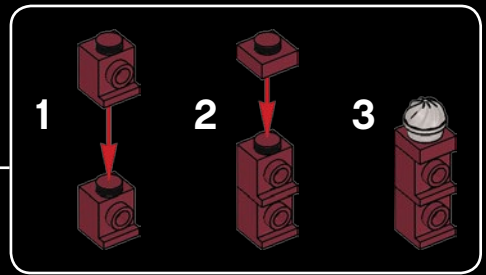
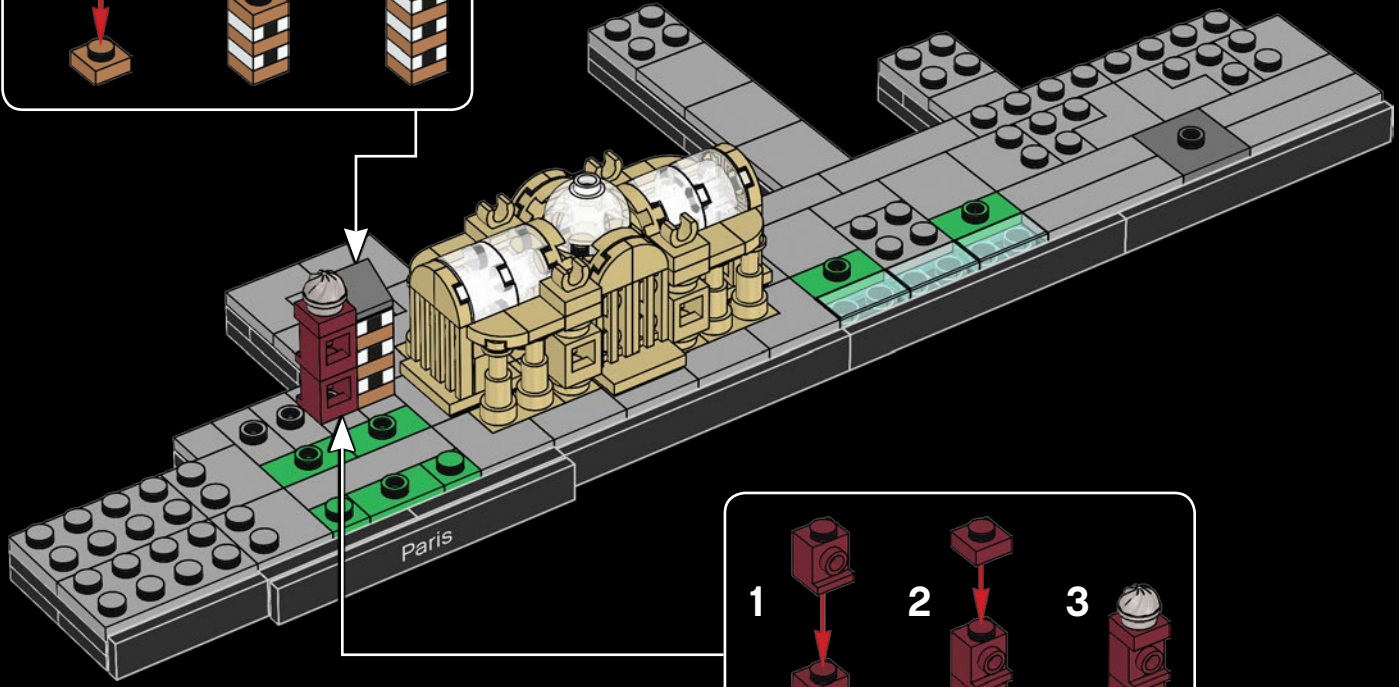
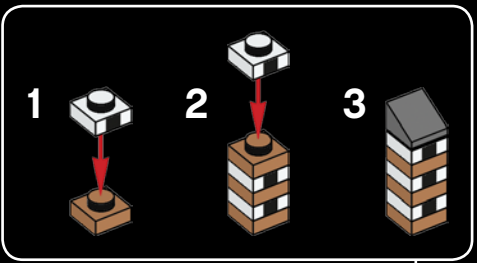



3x



3x



2x



2x

36

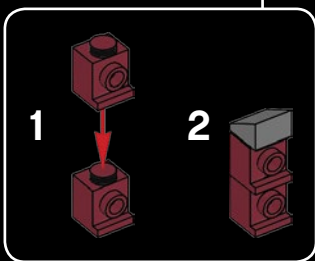
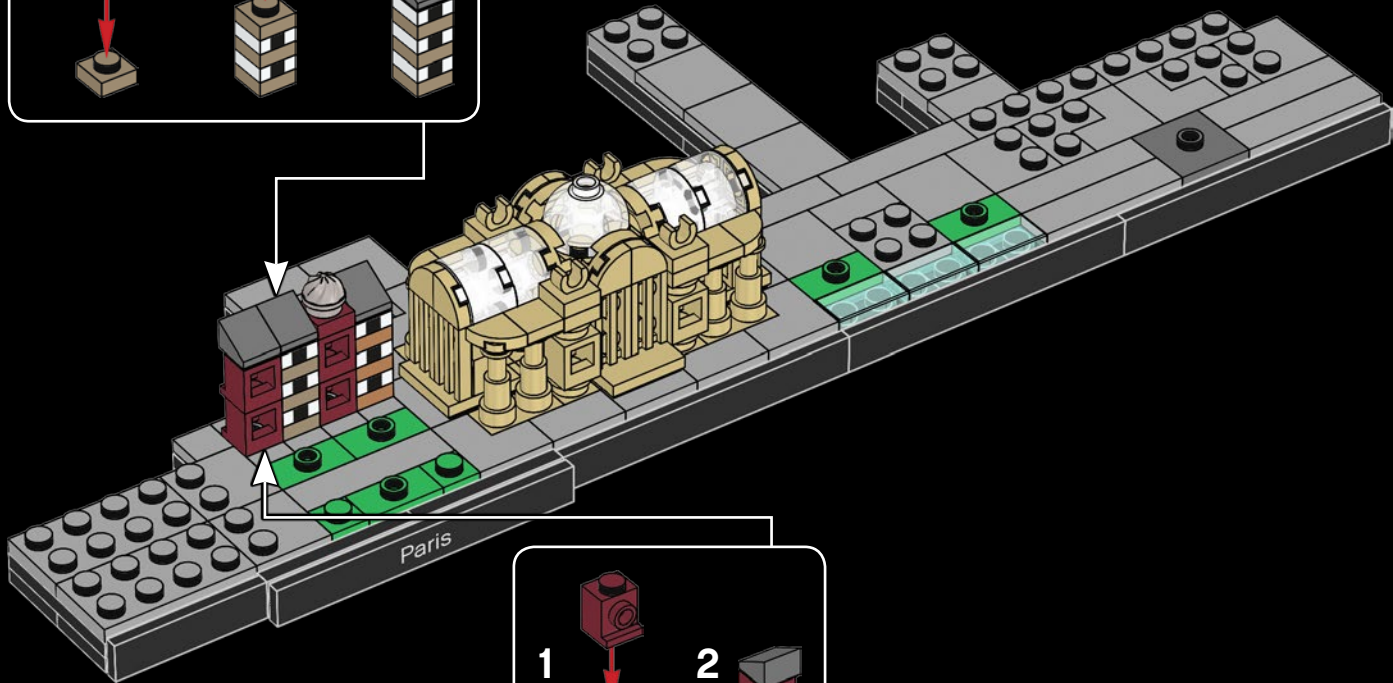
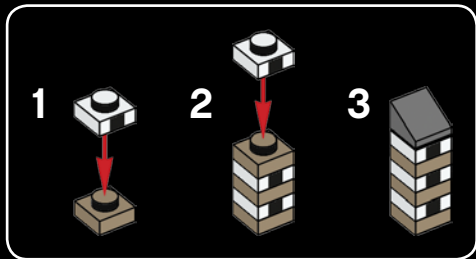



5x



10x

37

1



2



5x

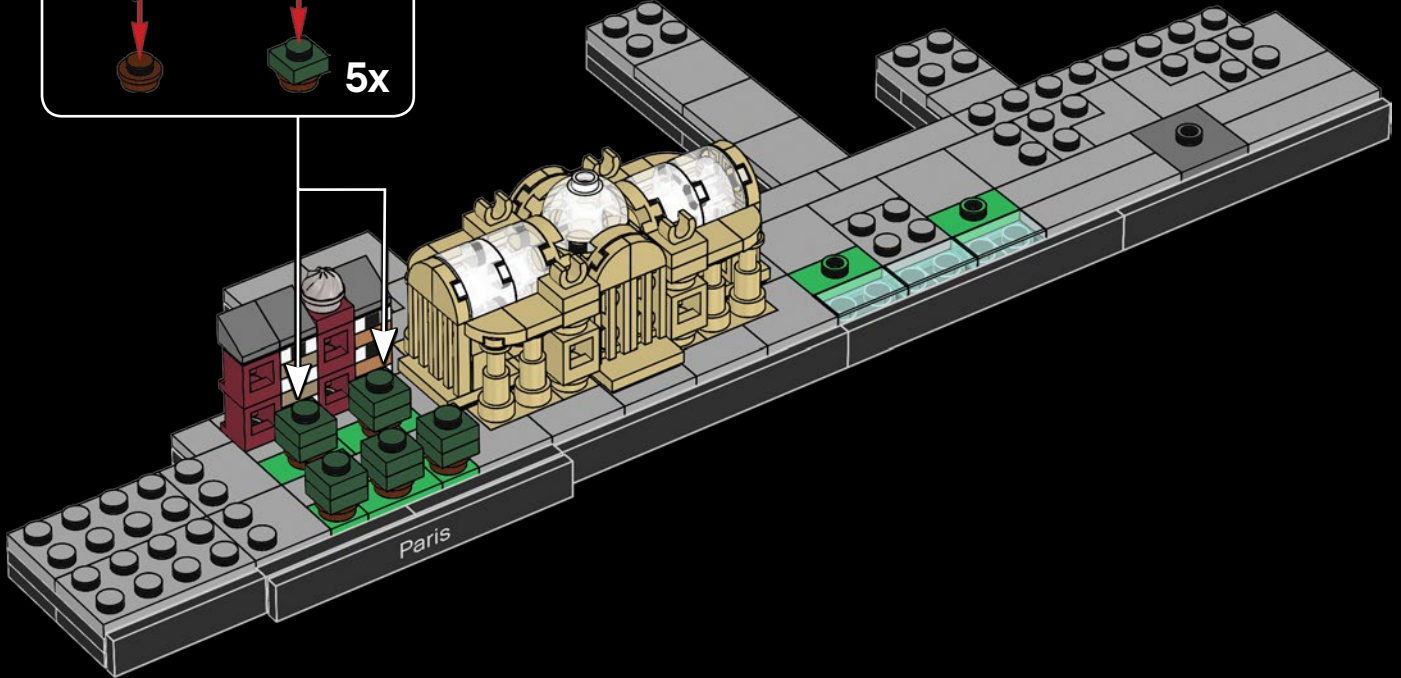

The Most Glamorous Cycle Path

This prestigious avenue has been the final destination of the Tour de France since 1975.

The riders do a series of circuits back and forth along the Champs-Élysées as a finale before the awards ceremony.

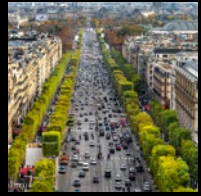

La piste cyclable au sommet du glamour

Cette prestigieuse avenue accueille l'arrivée du Tour de France depuis 1975. Les coureurs

font une série d'allées et venues le long de l'avenue des Champs-Élysées avant de franchir la ligne d'arrivée et d'assister à la cérémonie de remise des prix.

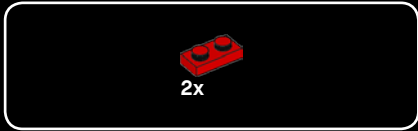
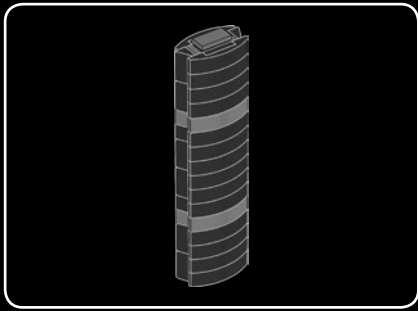

38

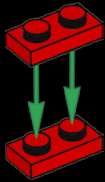

39

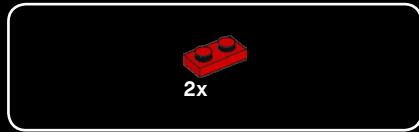

40

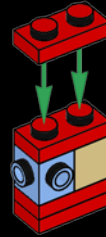

41



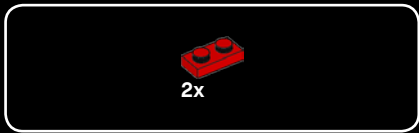

42



43

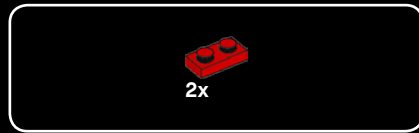

44



45





2x

46



1x



1x

47





2x

50



1x



1x



1x

51



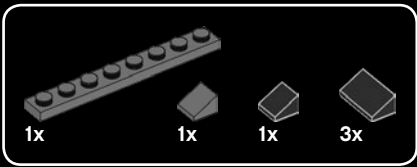

52

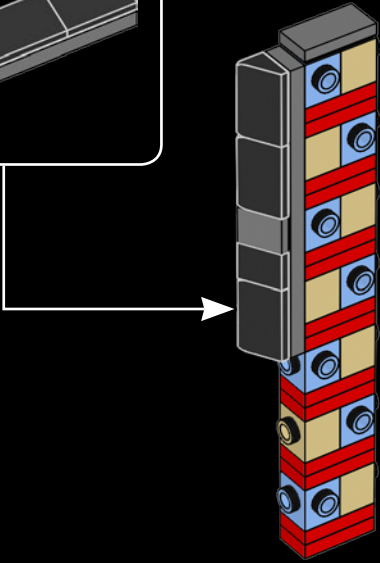
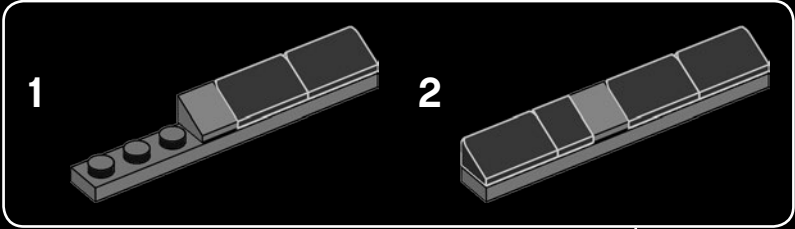

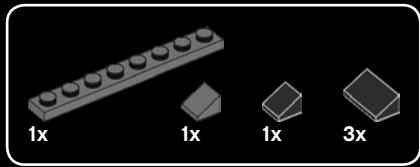

53

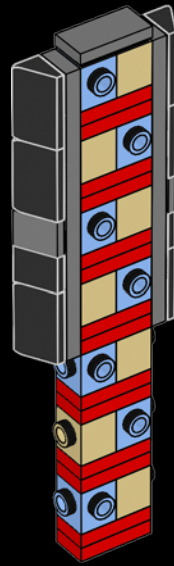
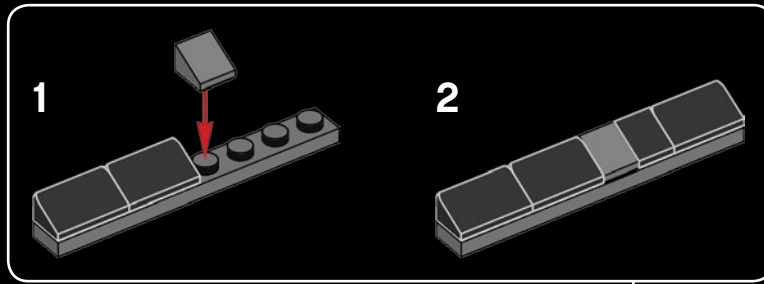

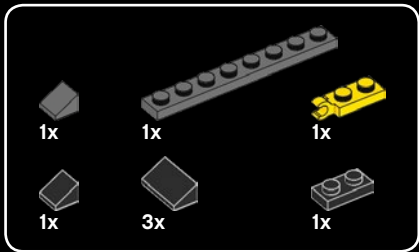

54

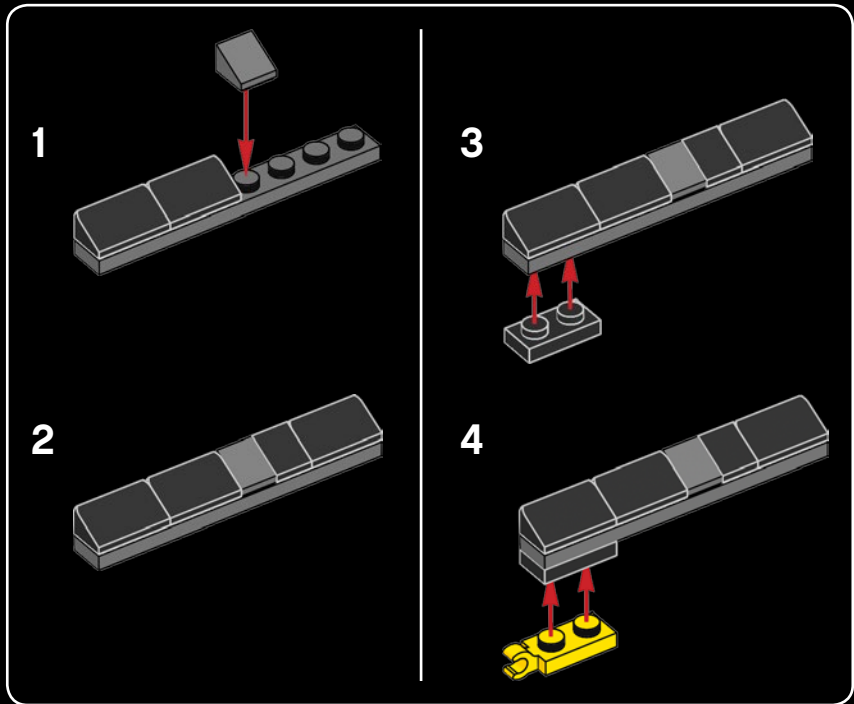
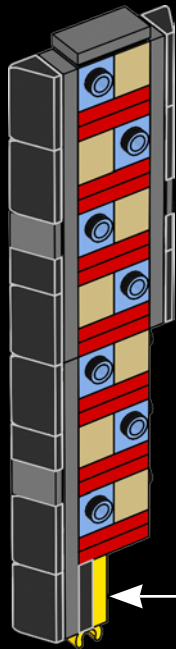

55

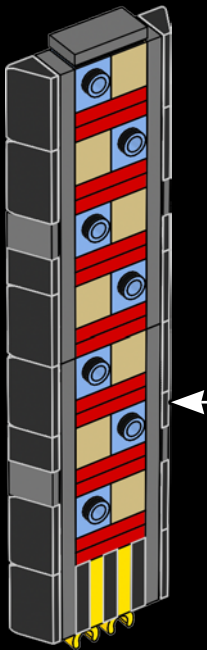
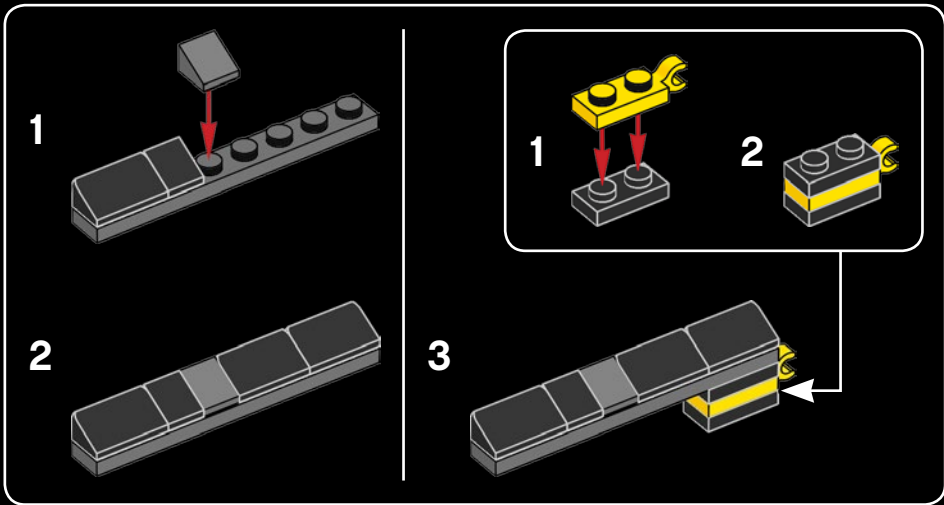
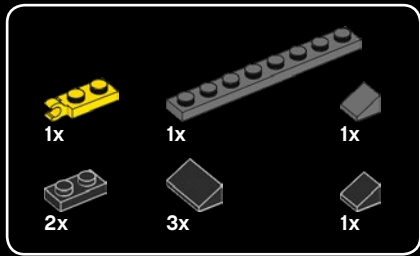

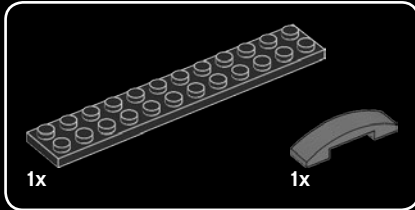
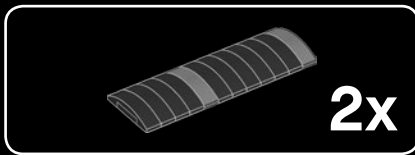

56

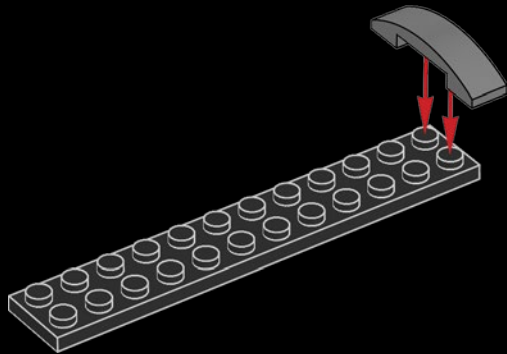

57

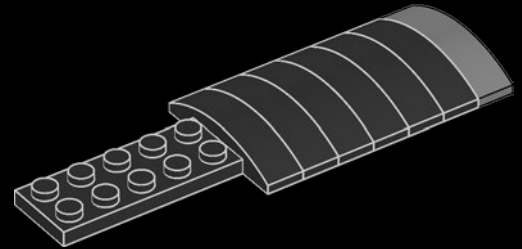

58

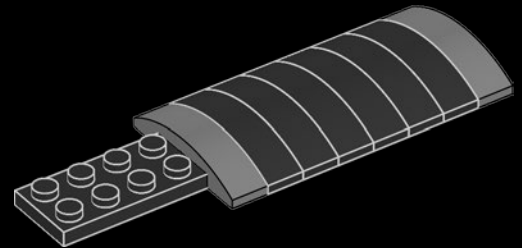



59

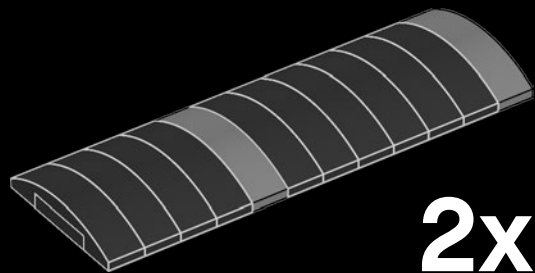

60

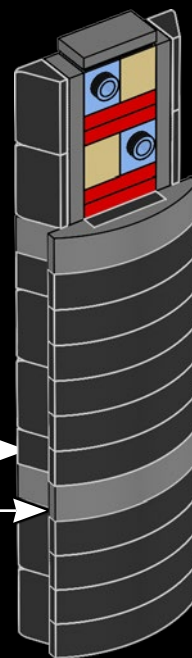

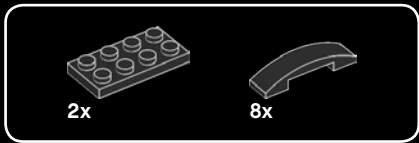

61

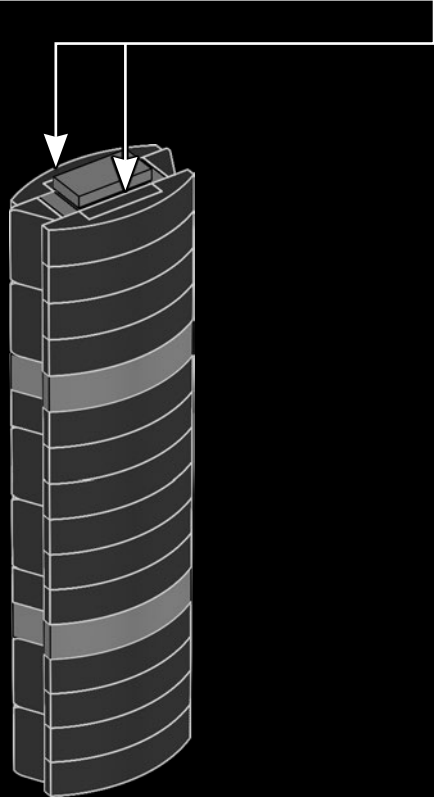
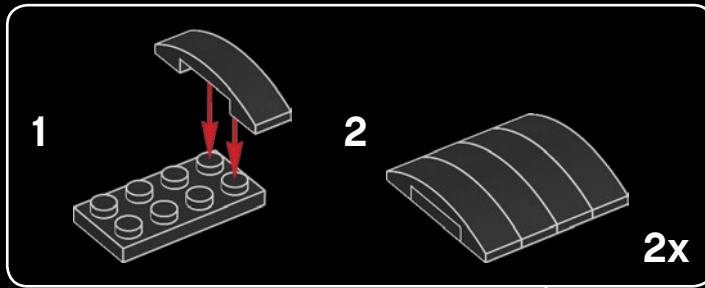

An Immense Window Cleaning Task
It is estimated that this 59-floor building has
7,200 windows.

**Une tâche colossale pour le nettoyage
des vitres**
On estime que ce bâtiment de 59 étages
compte 7 200 fenêtres.

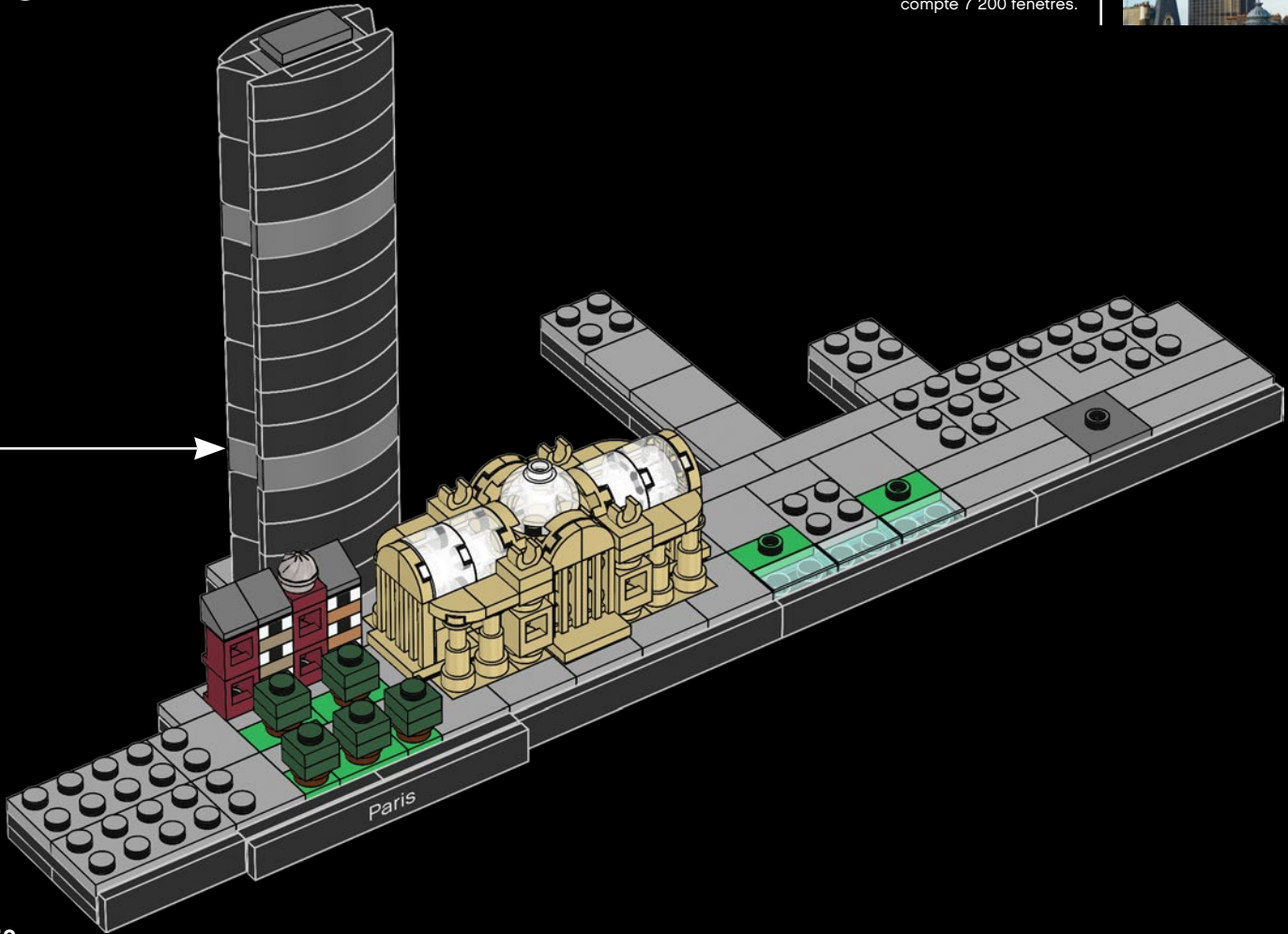

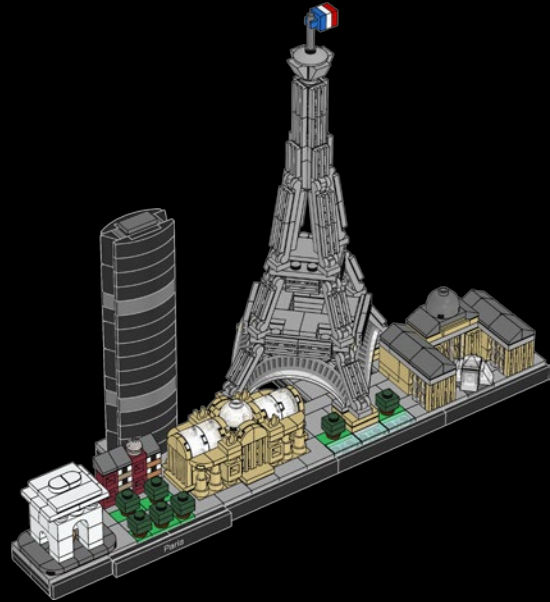

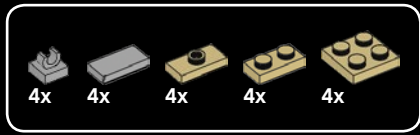

63

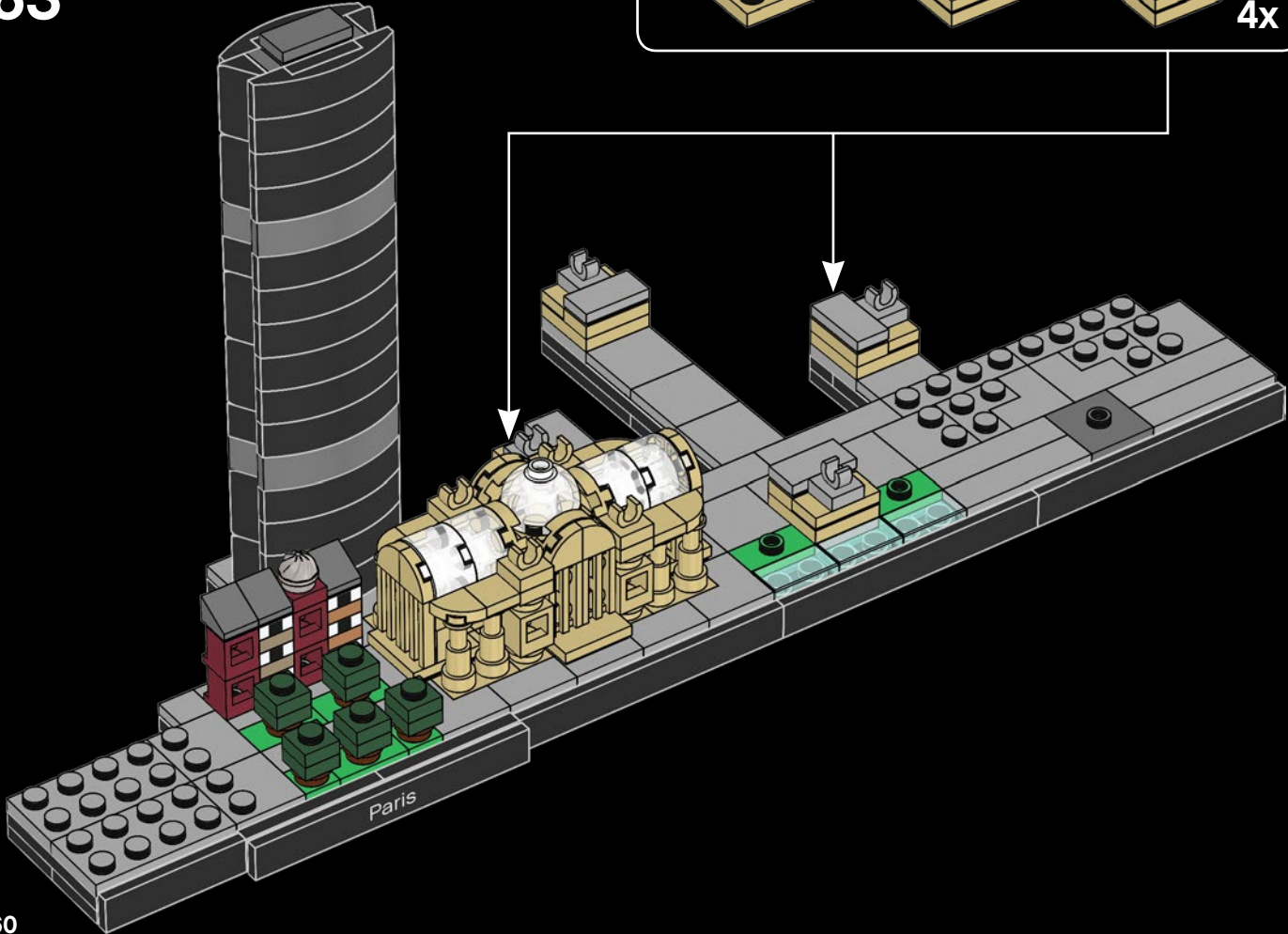
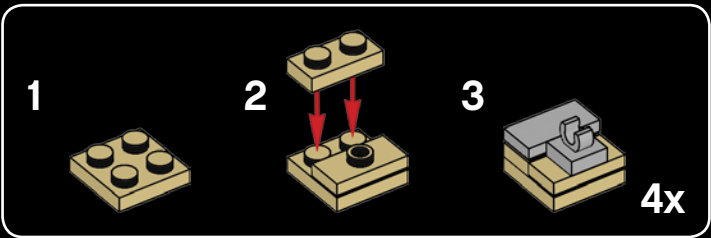

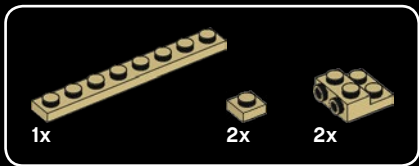

64

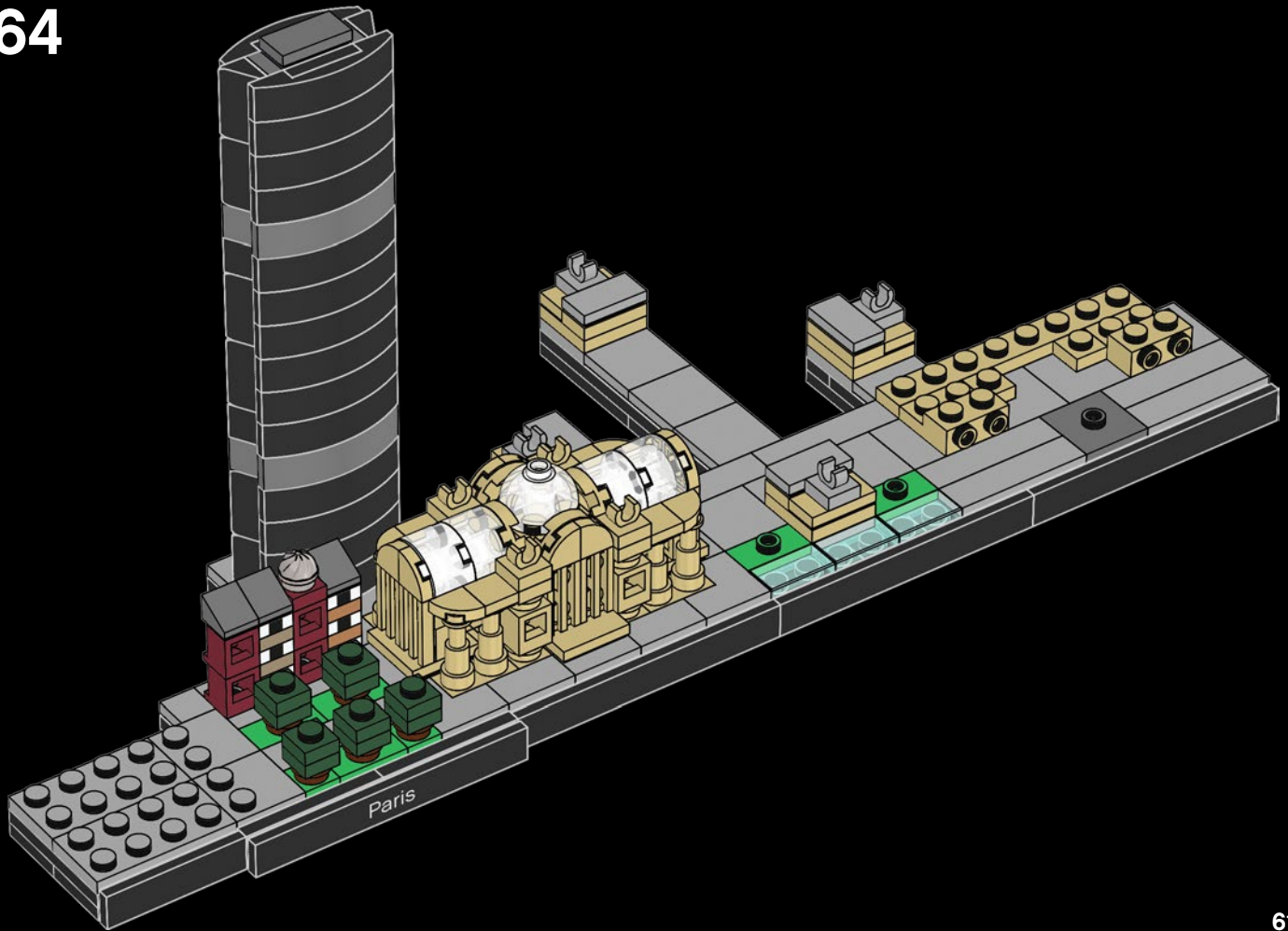



3x



2x

65

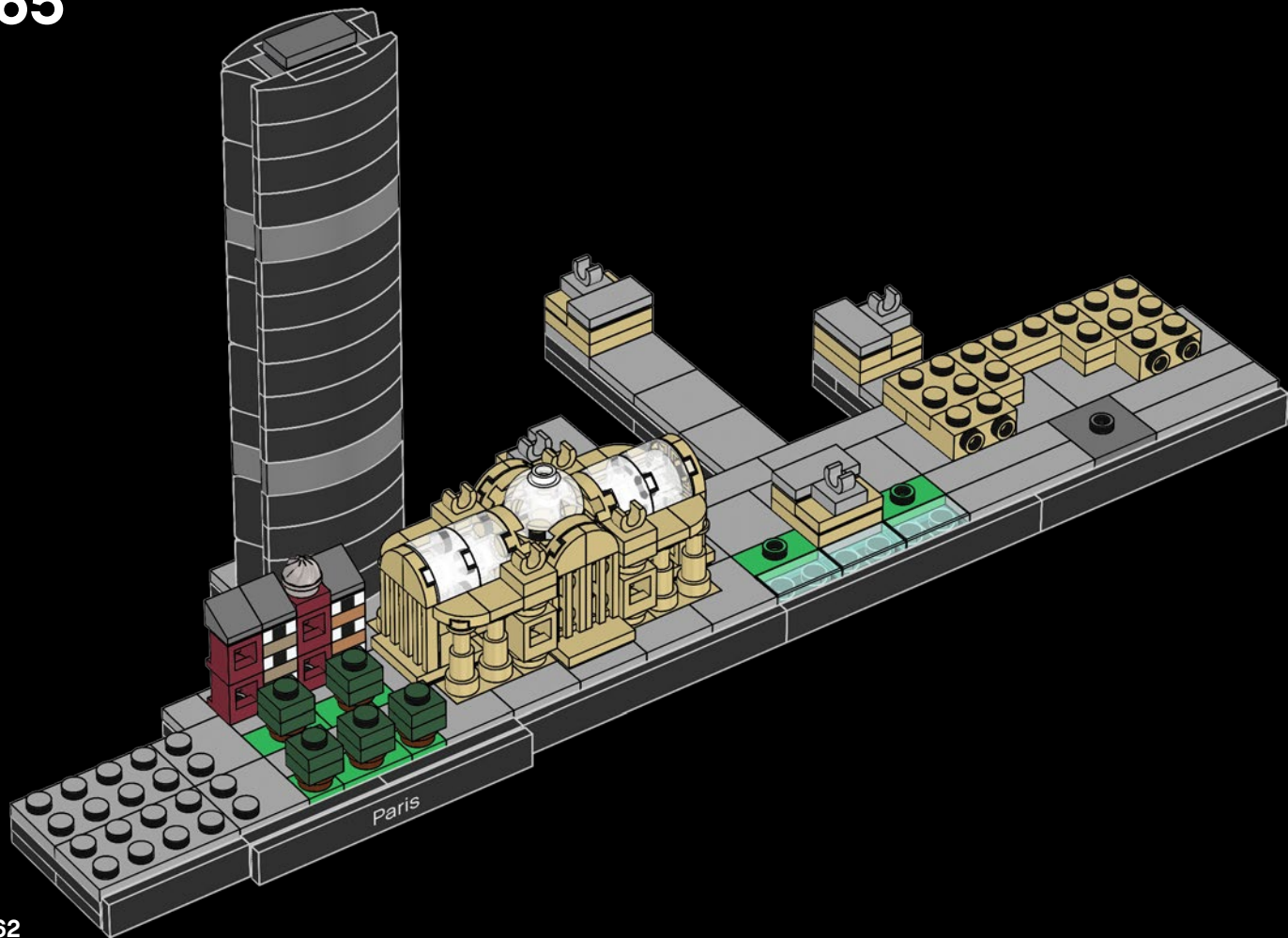

62

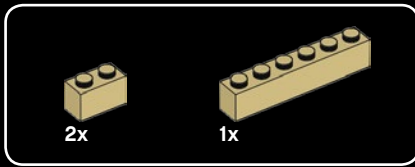

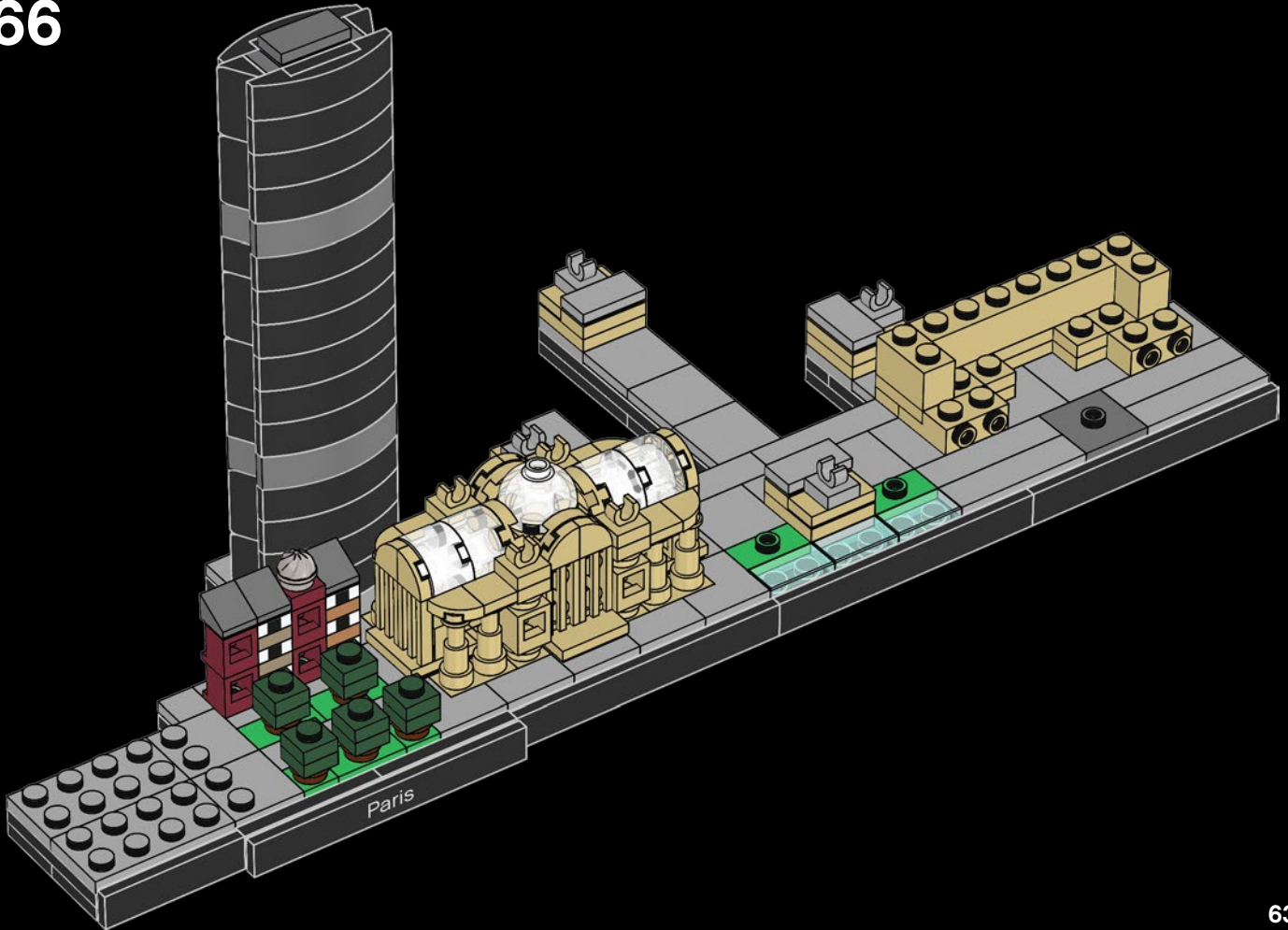

66

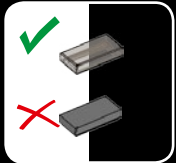

1x  4x  2x  1x 

67

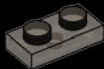
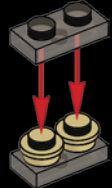
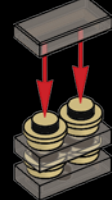
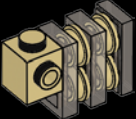

1  2  3  4  

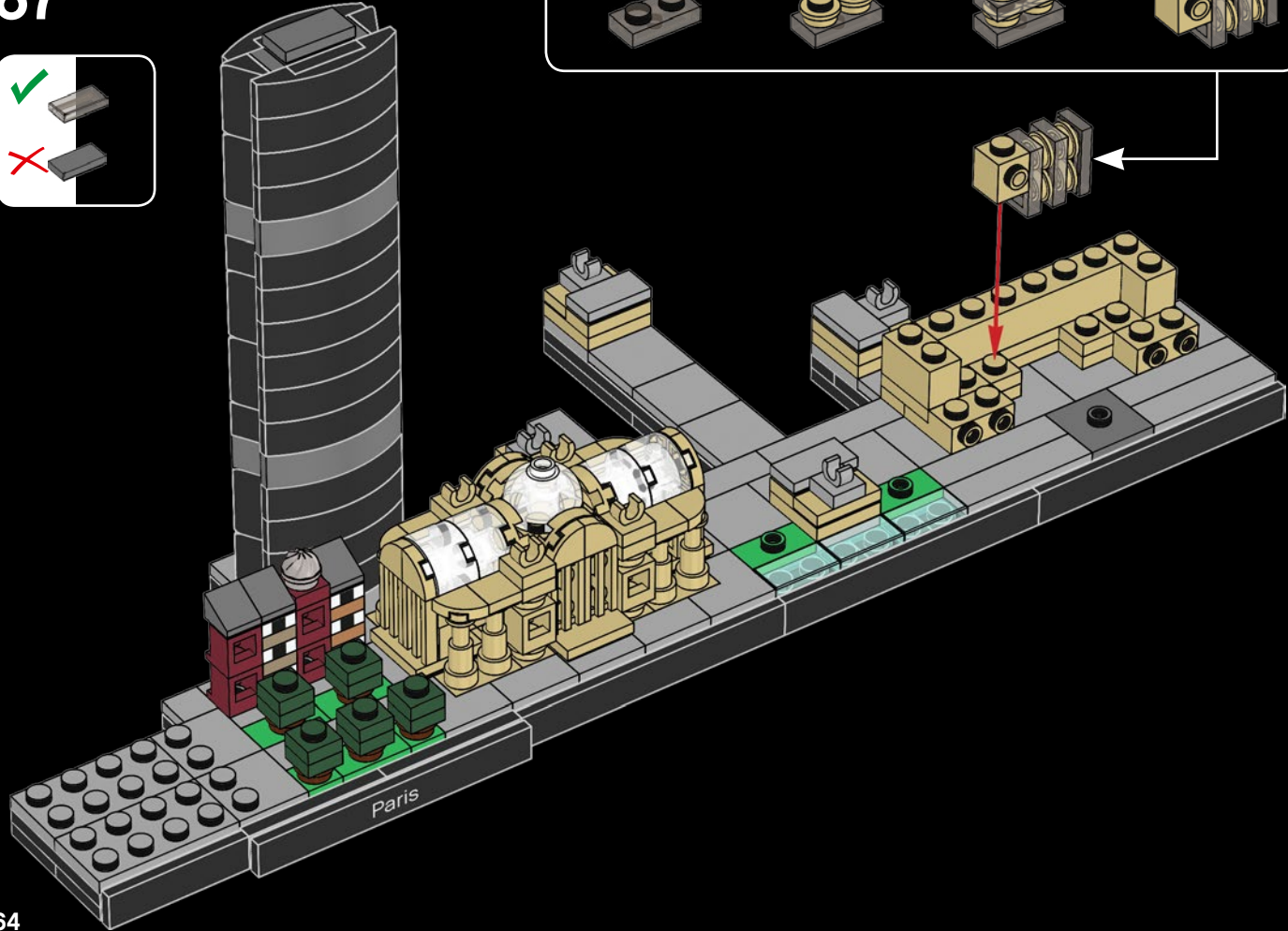



1x

68

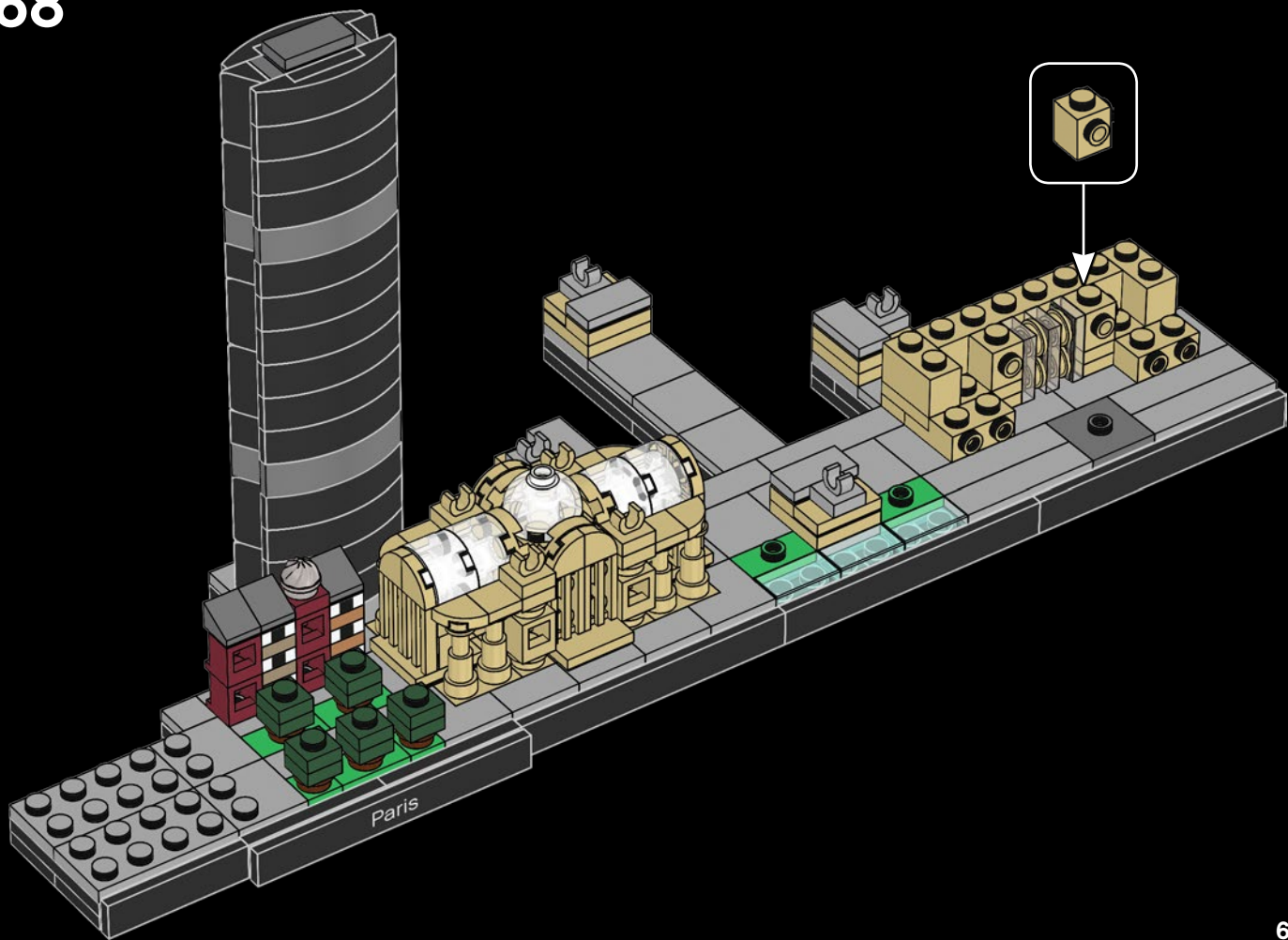

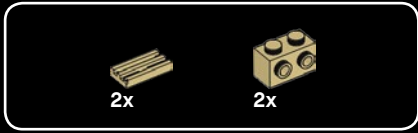

69

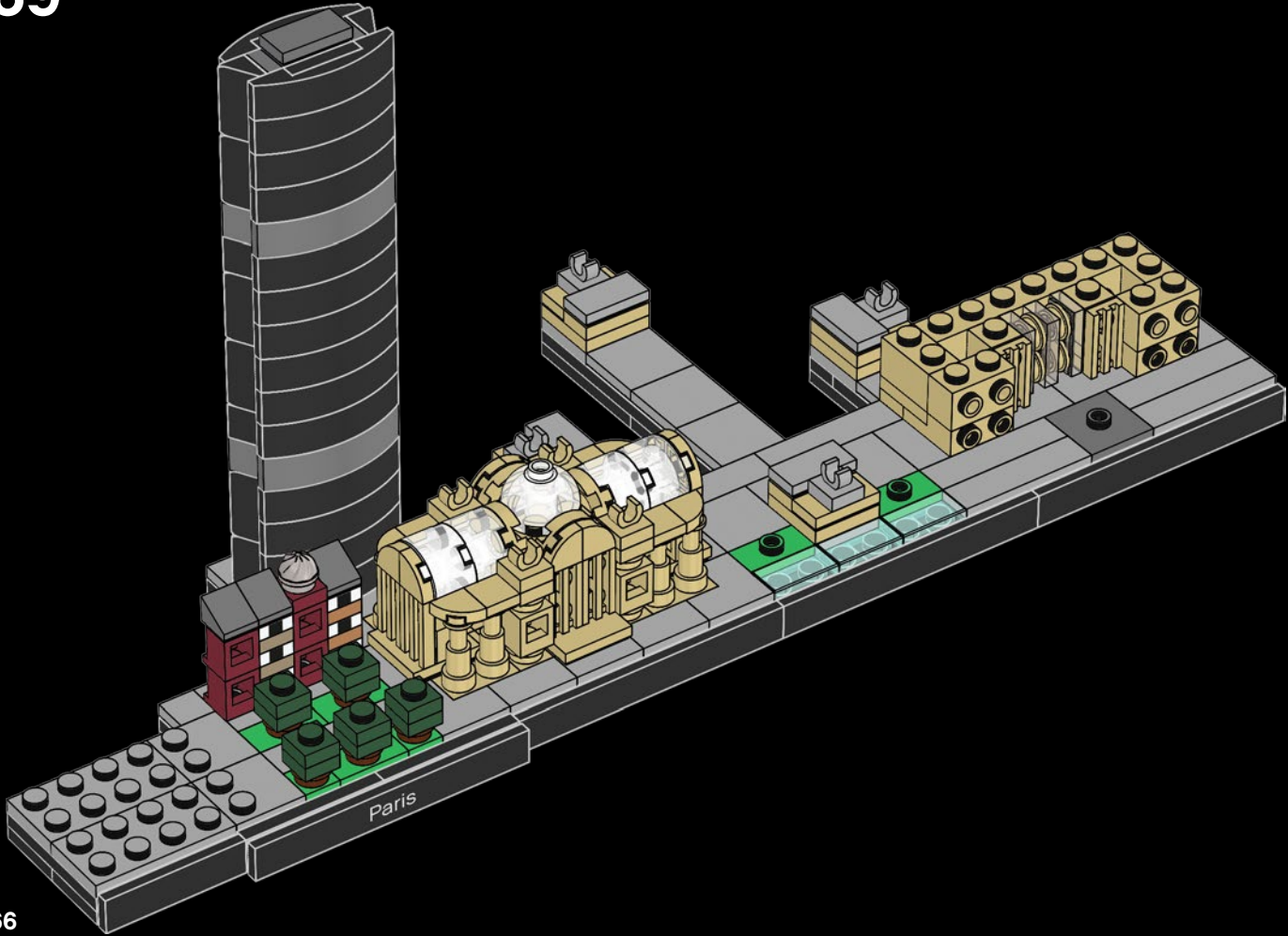



70

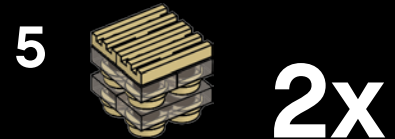
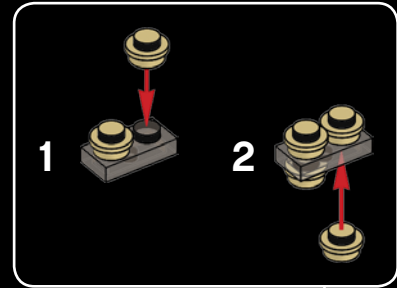
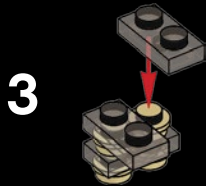
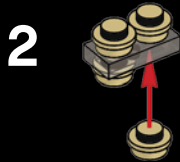
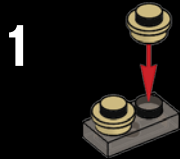

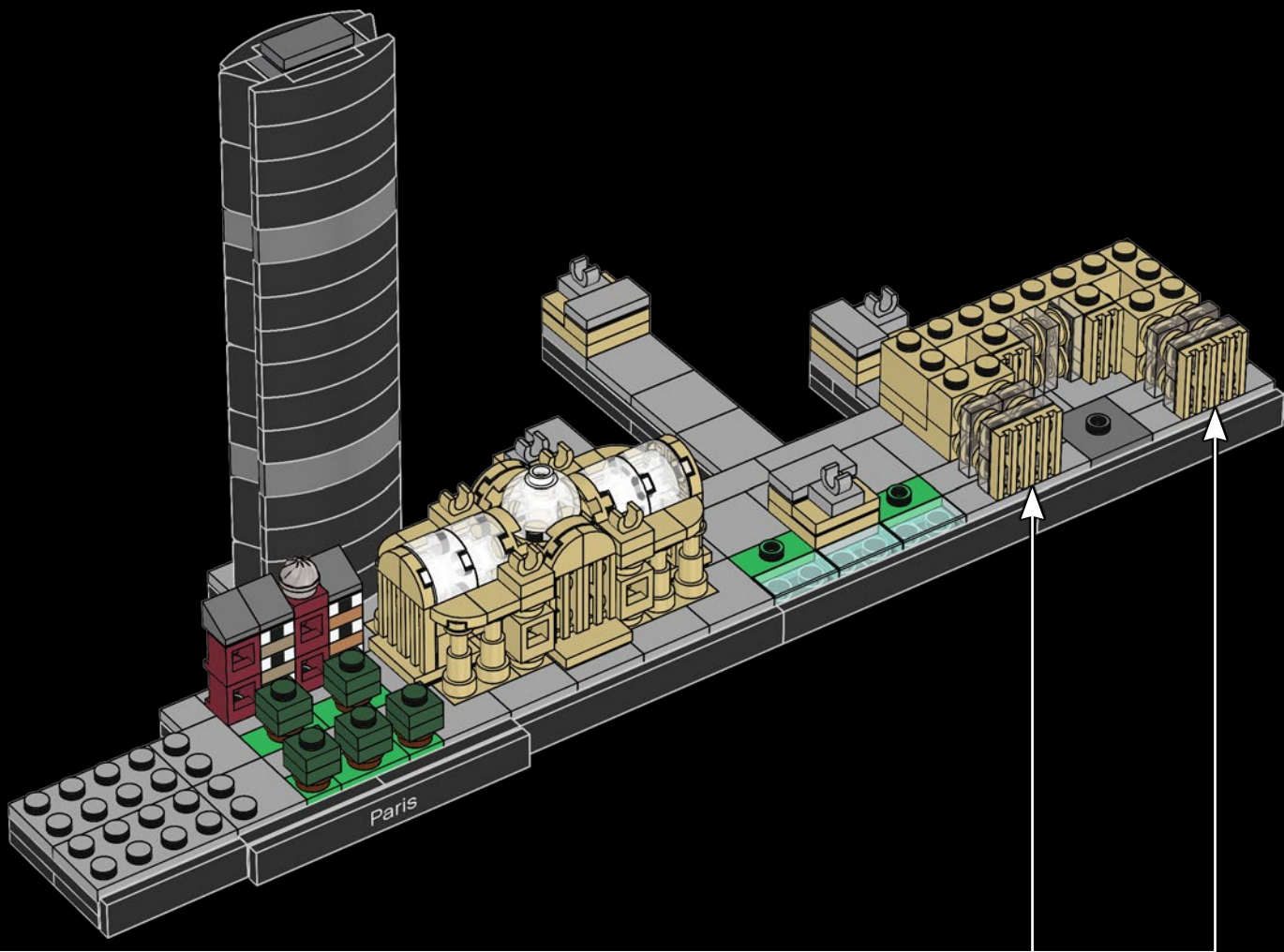

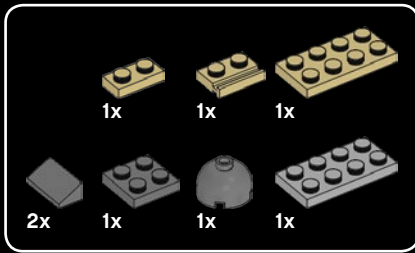

71

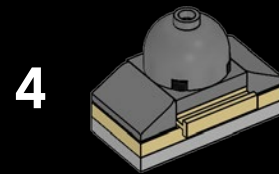
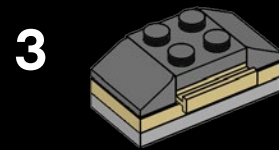
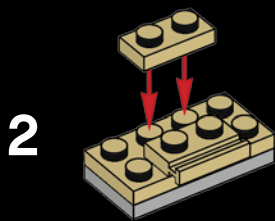
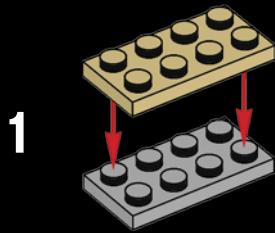

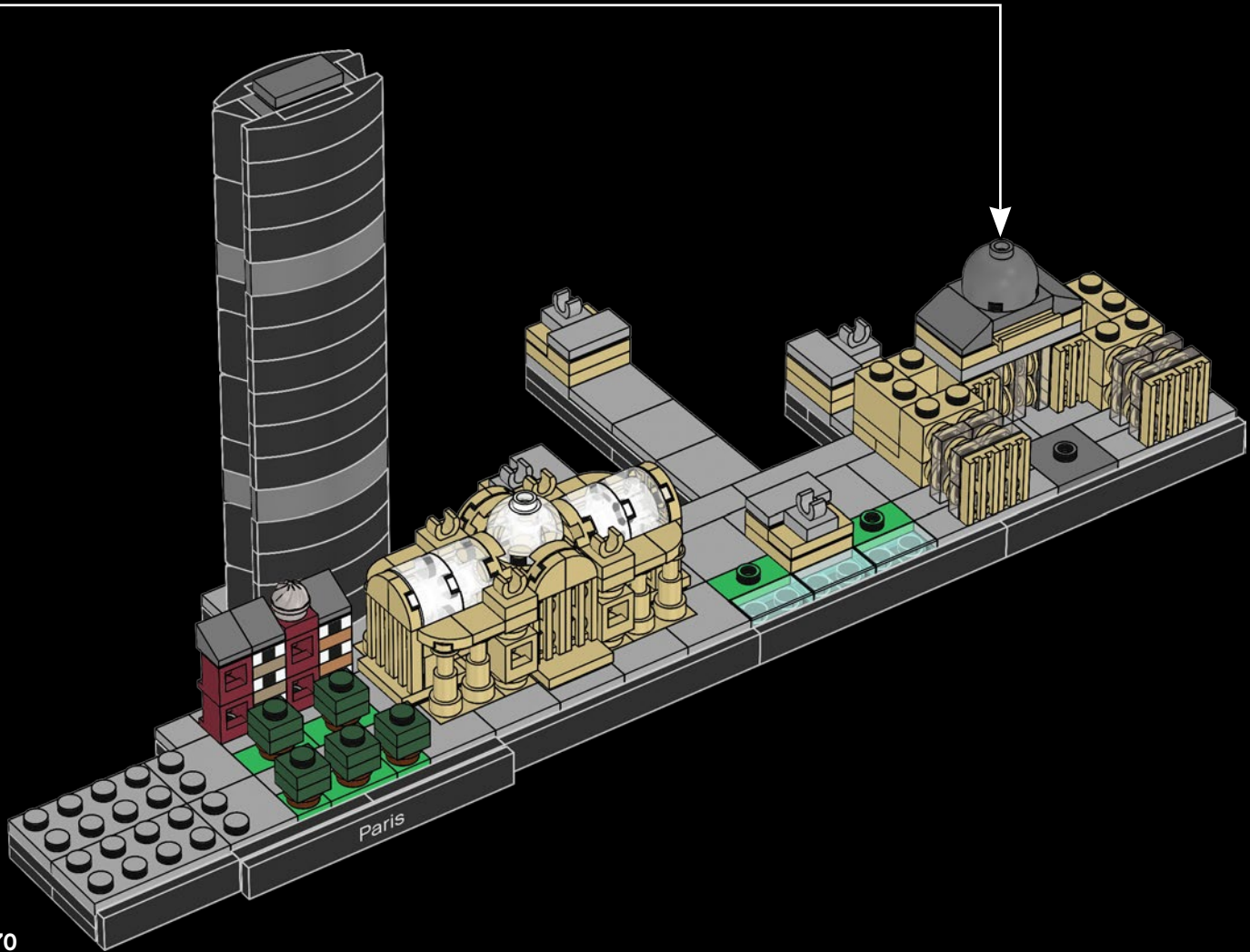

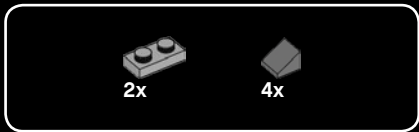

72

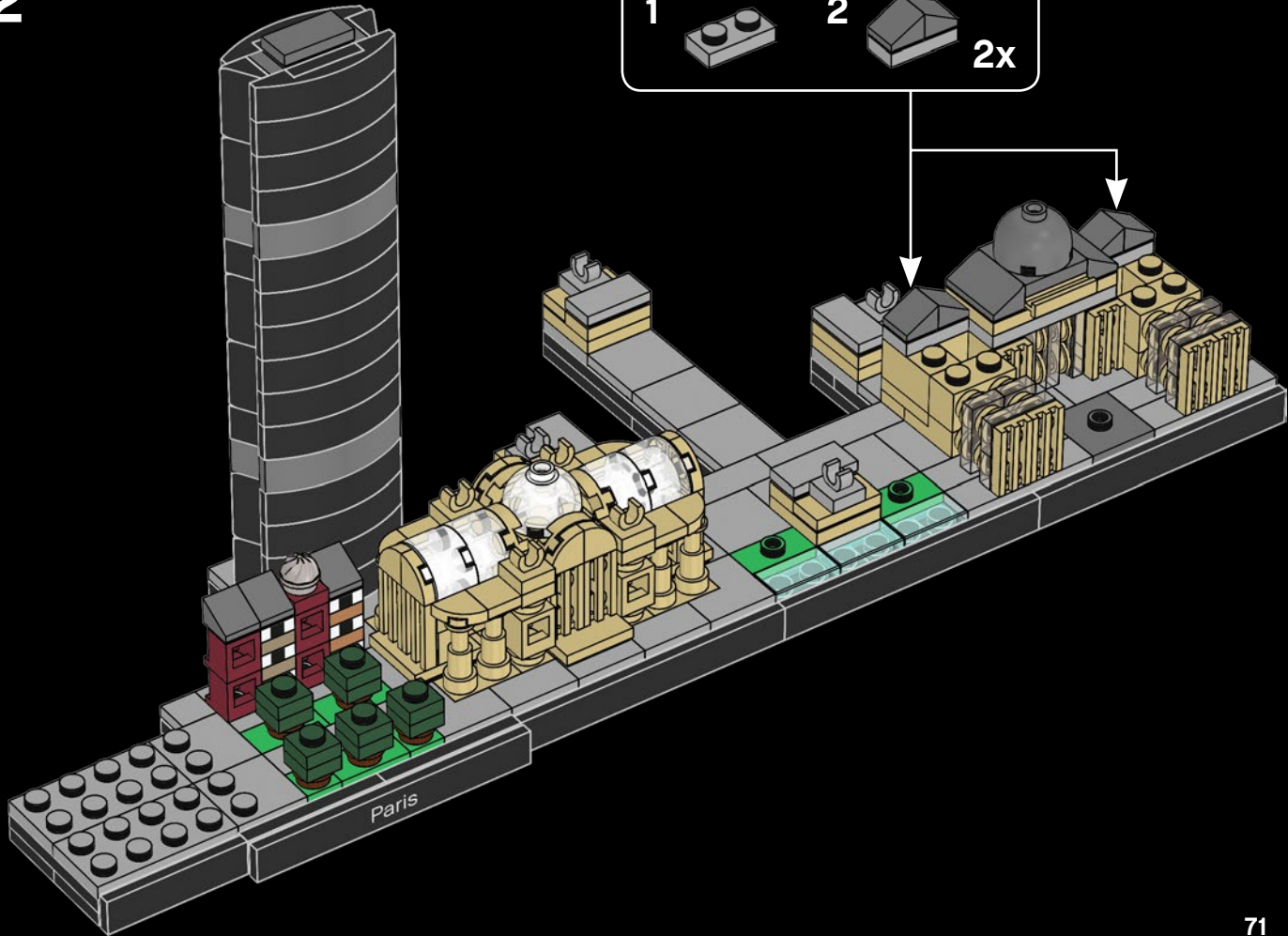
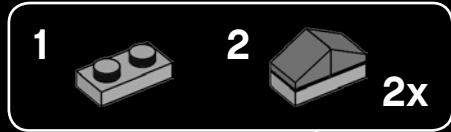

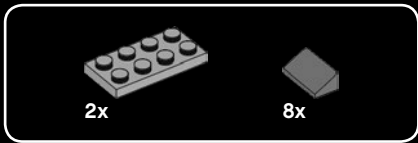

73

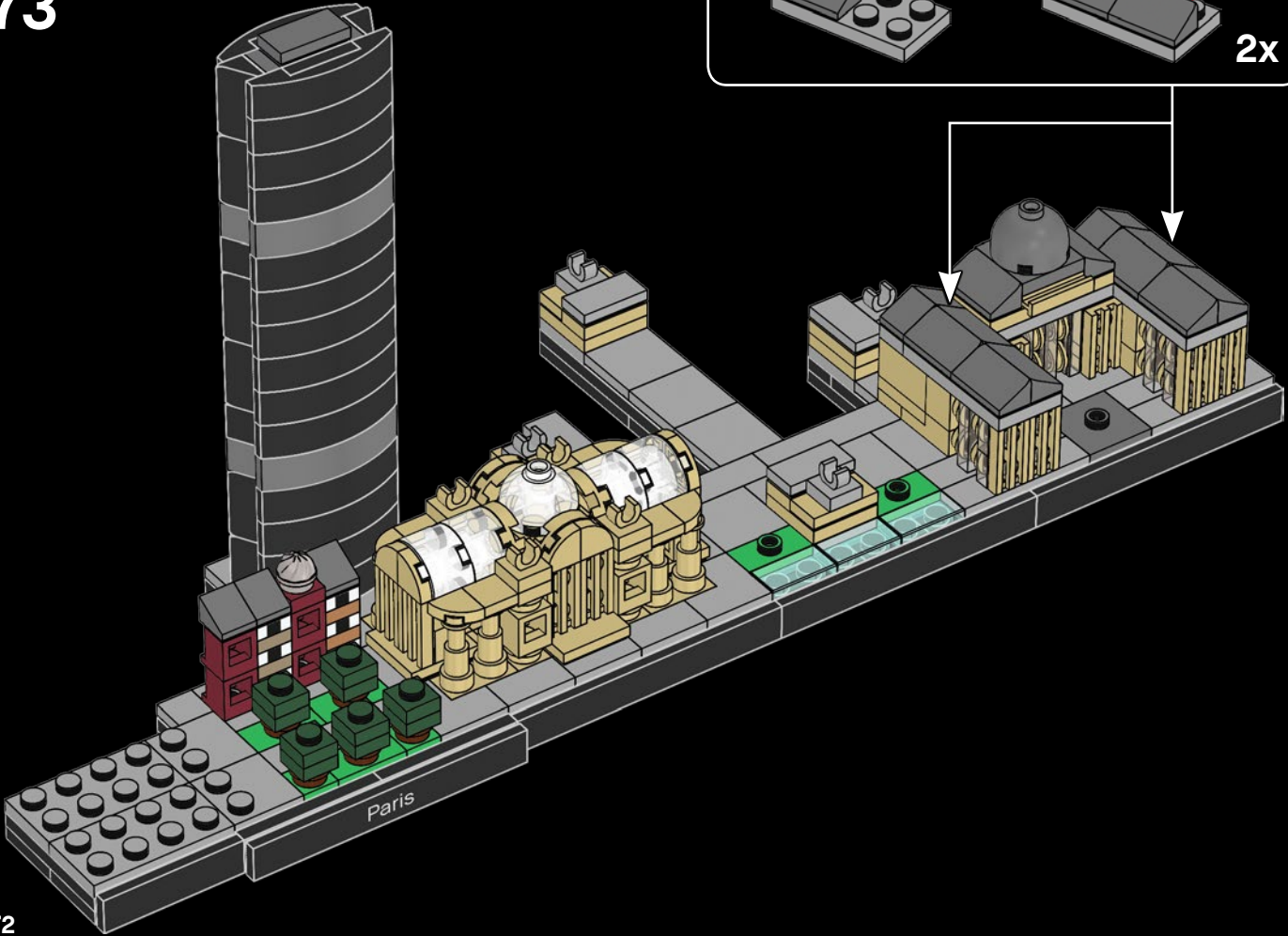
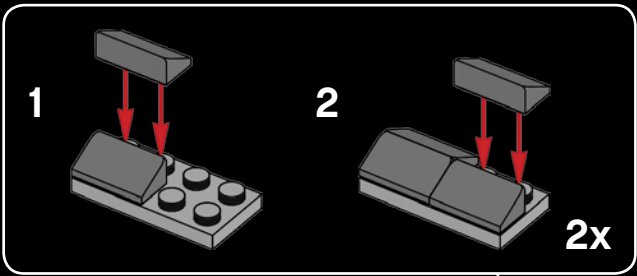



1x



4x



1x

74

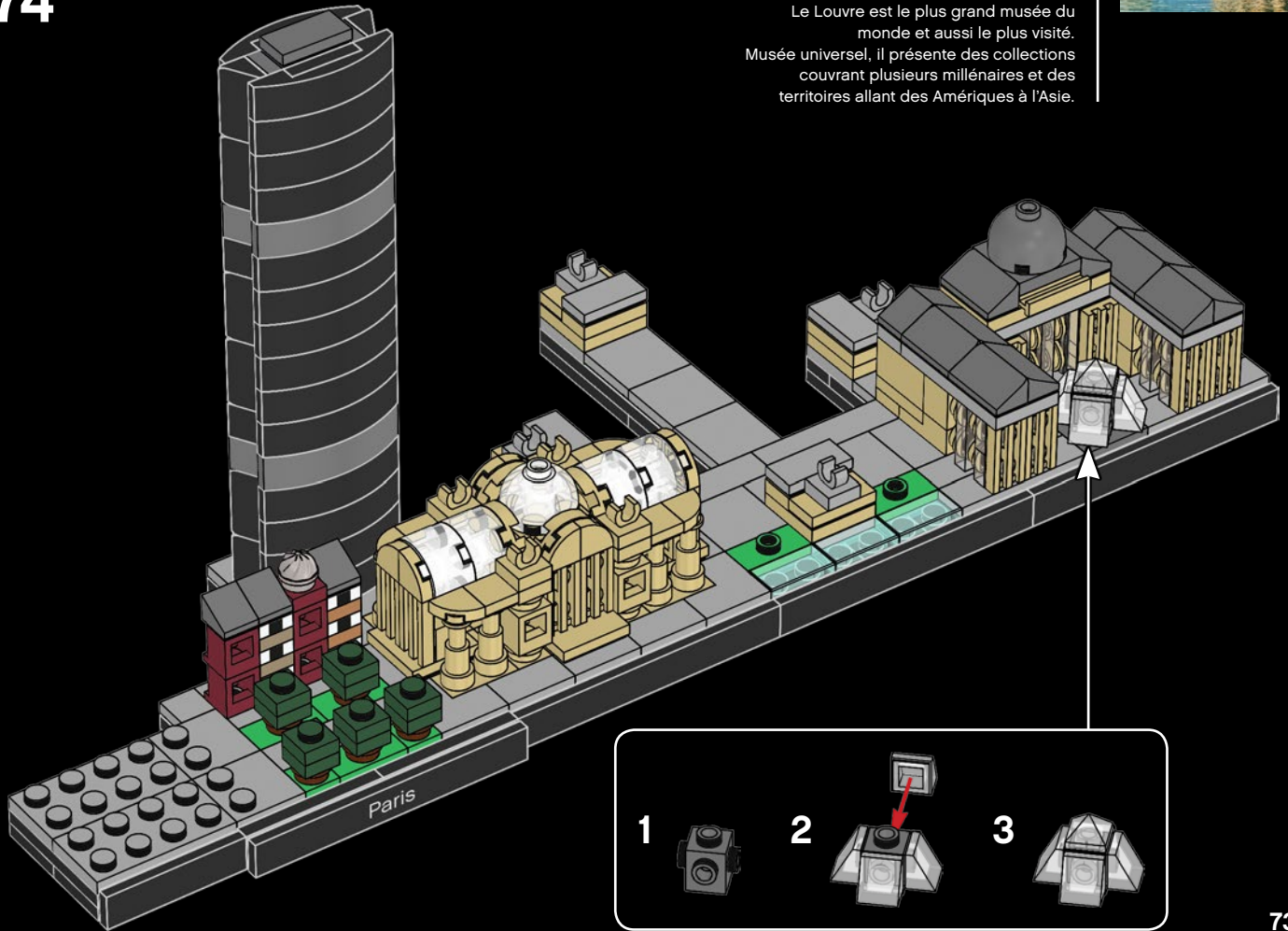

A universal museum

The Louvre is the largest and the most visited museum in the world.

As a universal museum, its renowned collections span many millennia and miles, from the Americas to Asia.

Un musée universel

Le Louvre est le plus grand musée du monde et aussi le plus visité.

Musée universel, il présente des collections couvrant plusieurs millénaires et des territoires allant des Amériques à l'Asie.





2x



4x

75

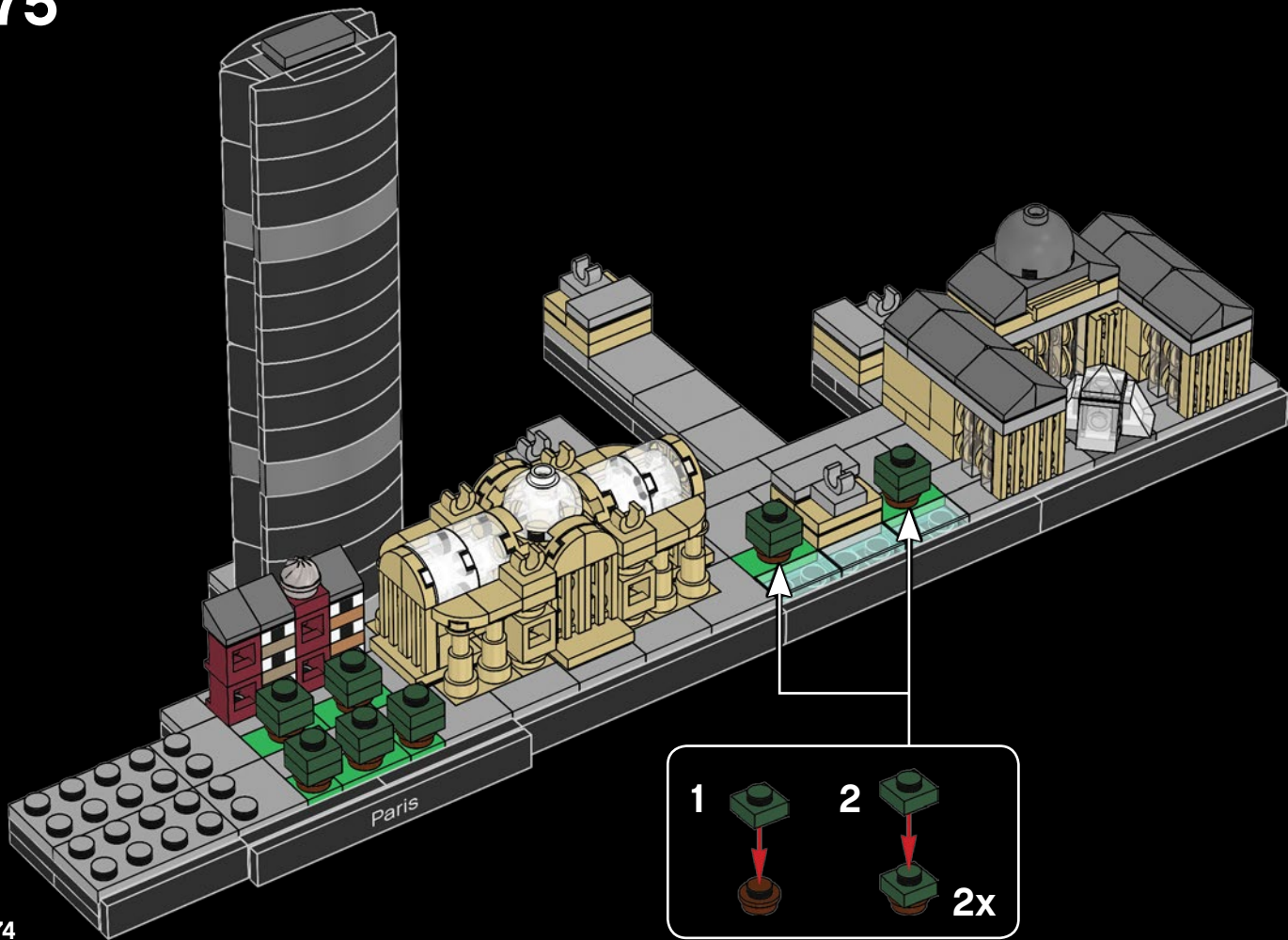

74

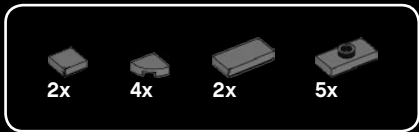

76

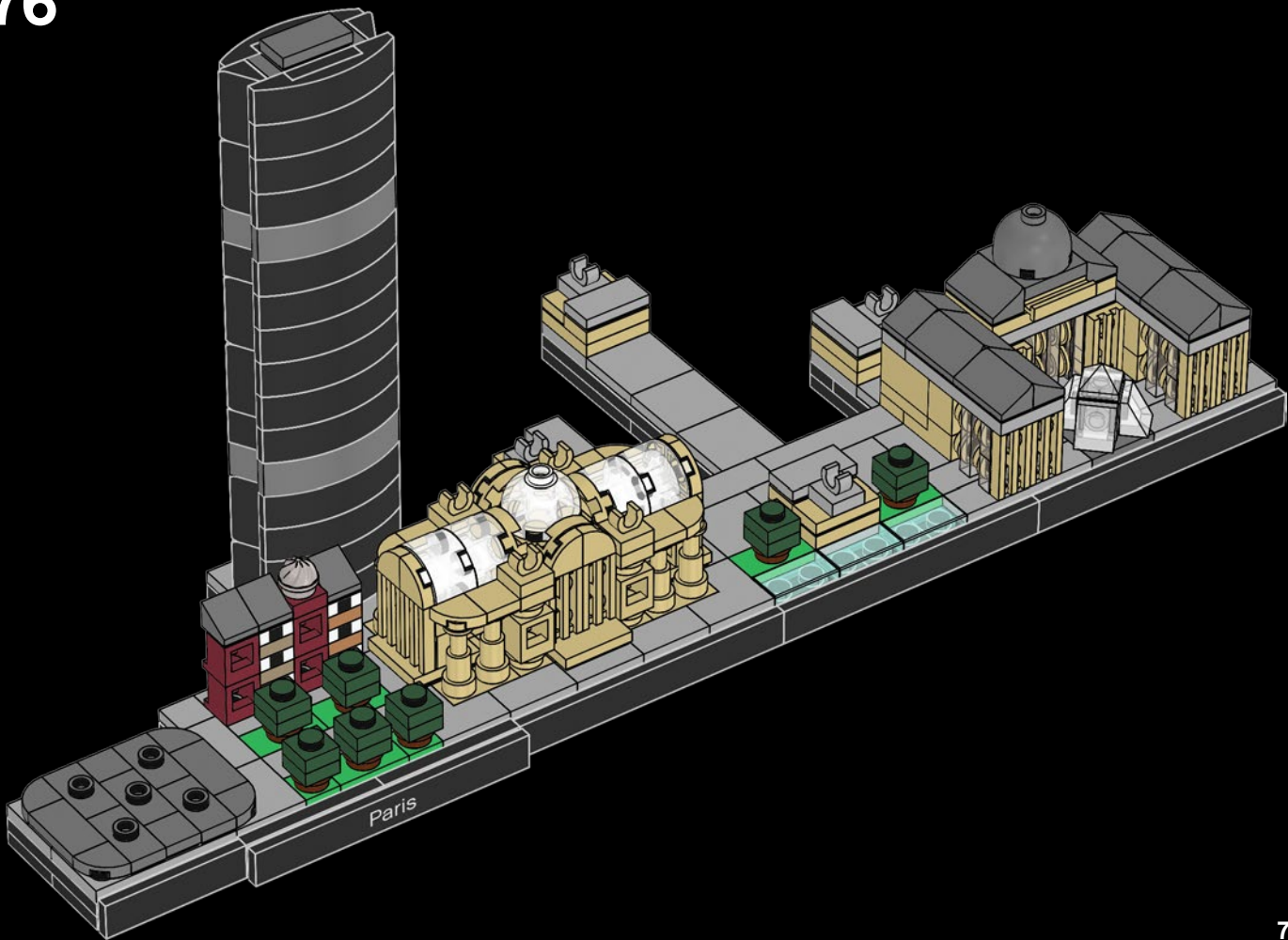



4x



1x

77

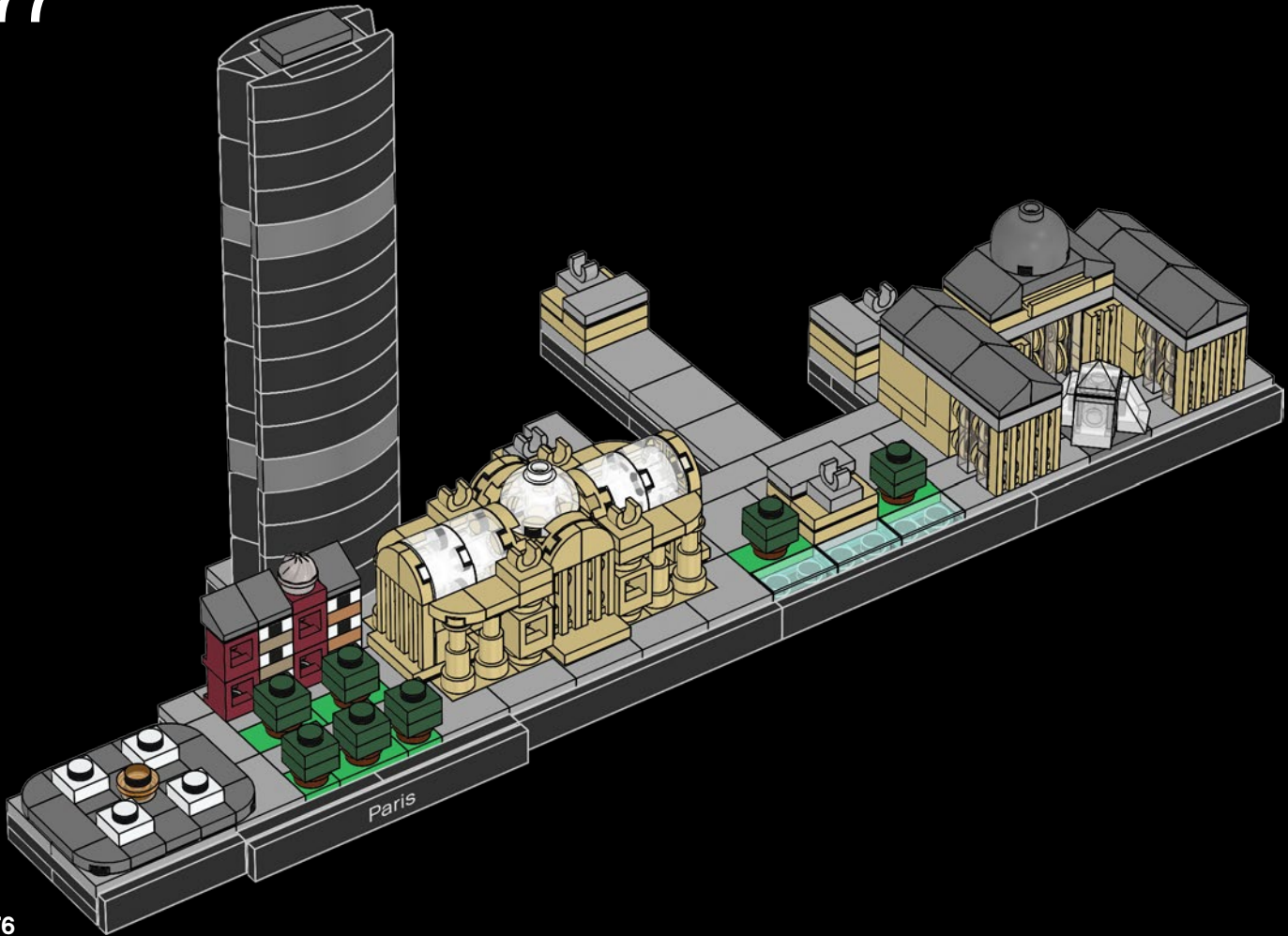

76

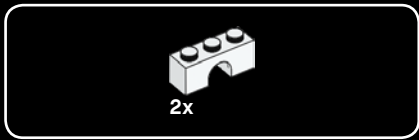

78

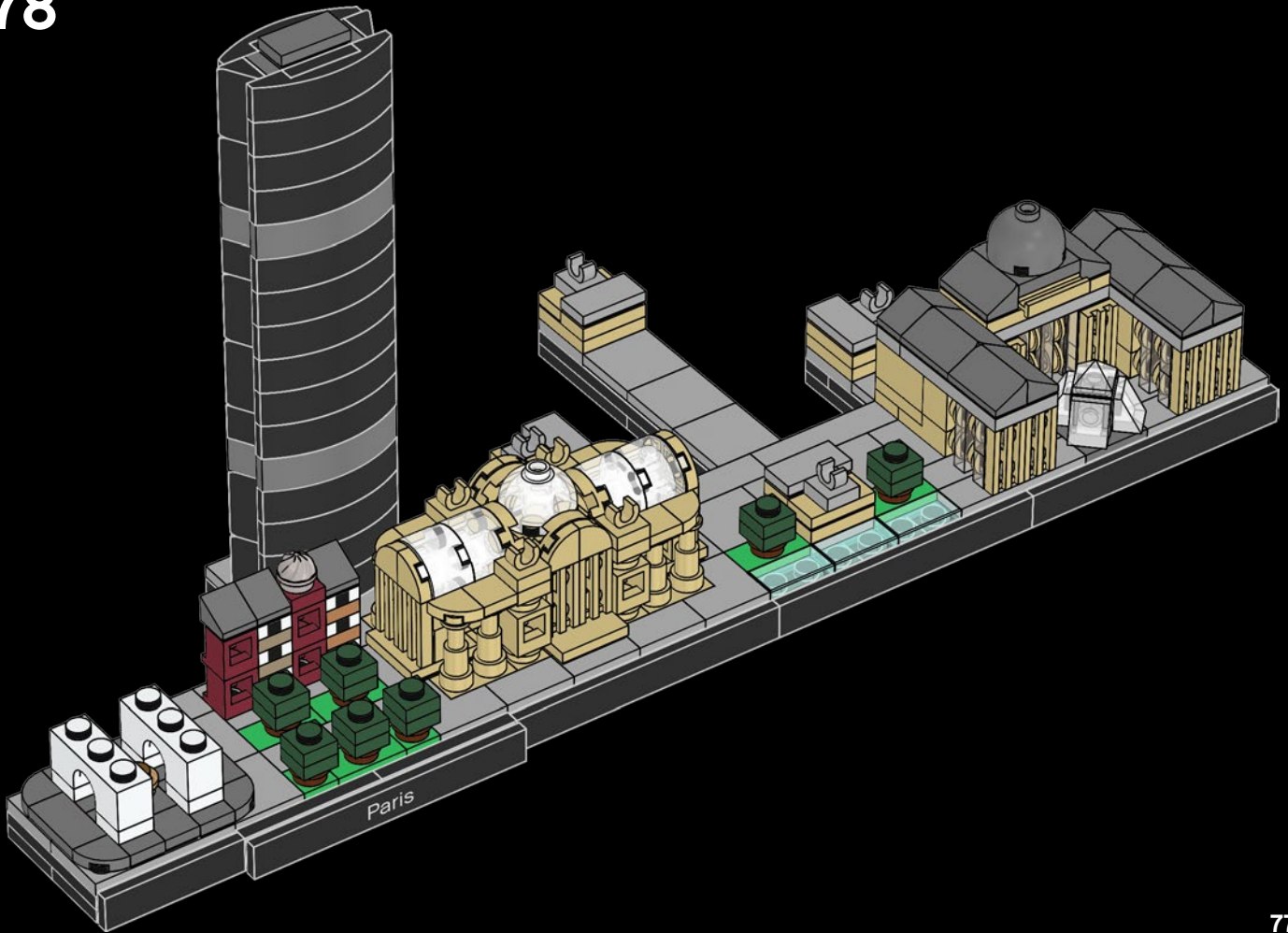



3x

79

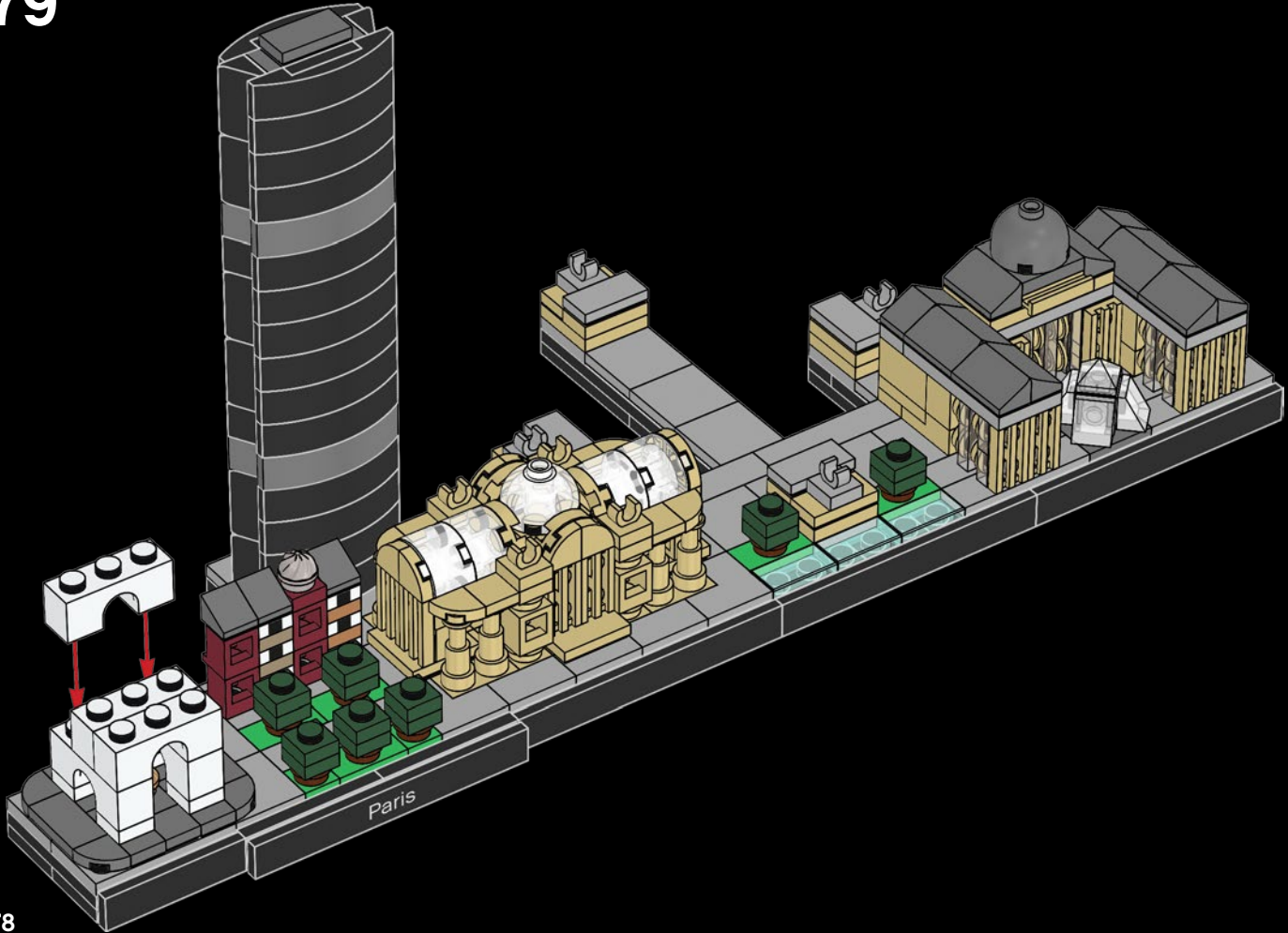

Paris

78



6x



2x

80

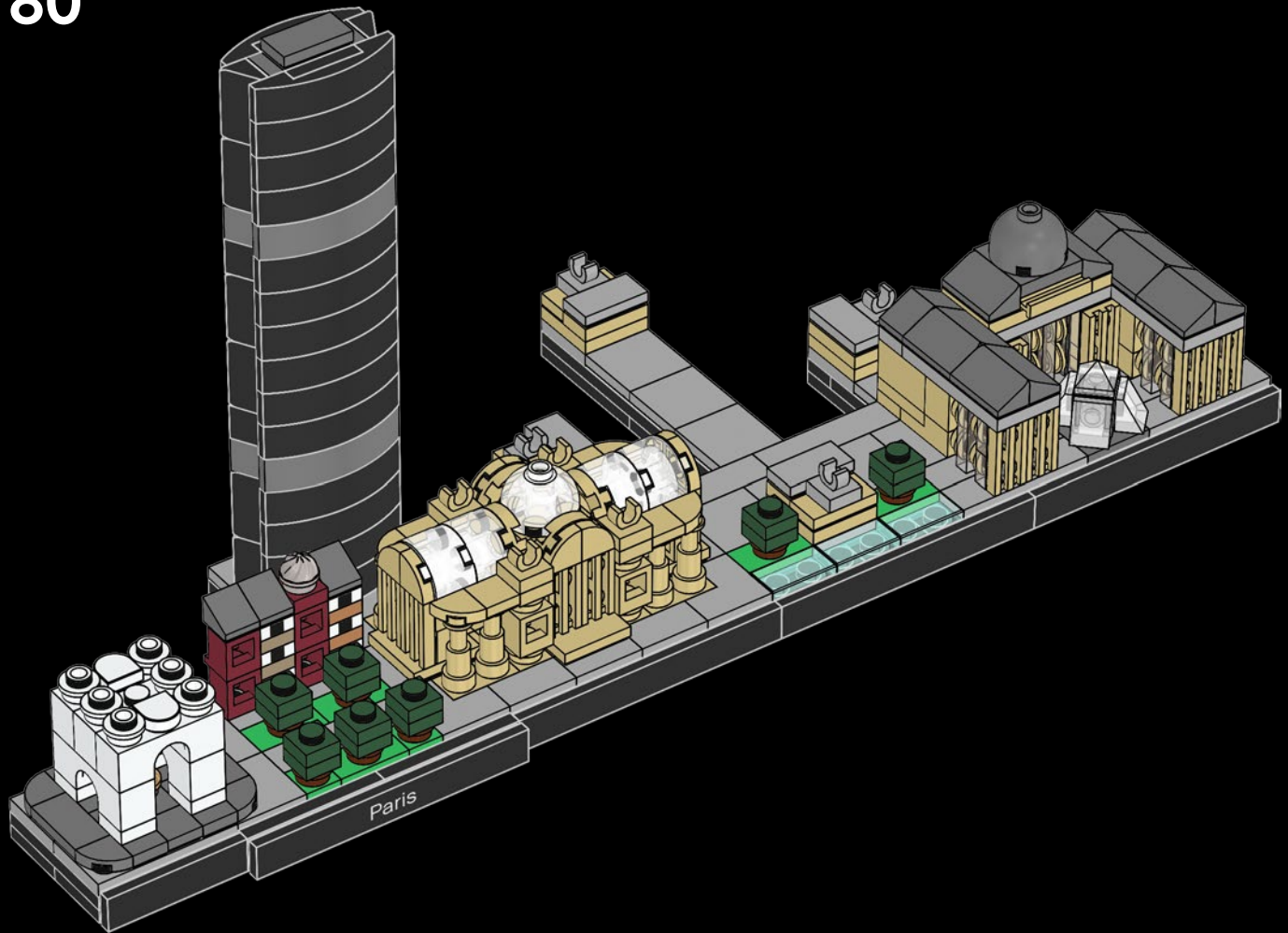



6x

81

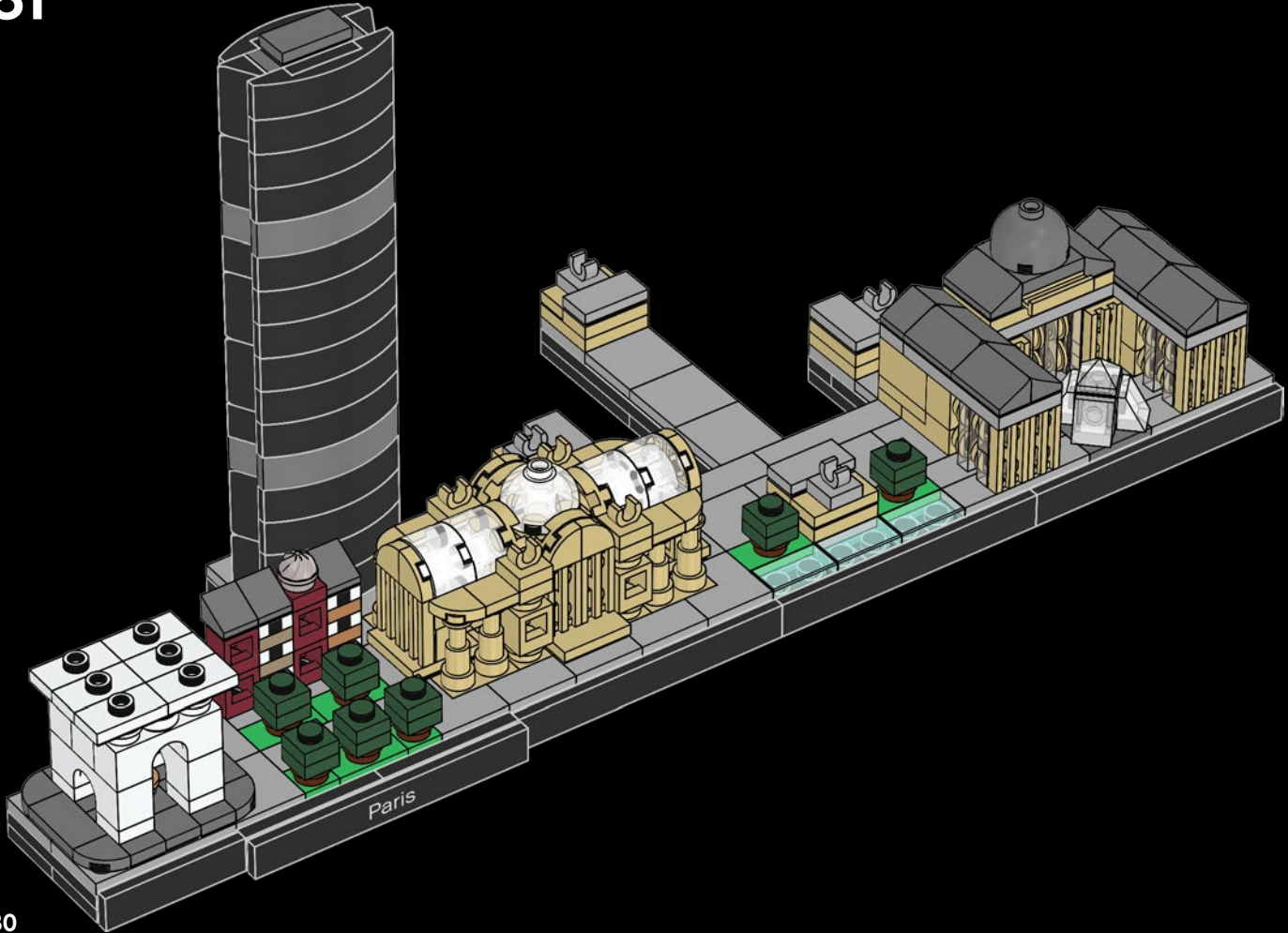

80

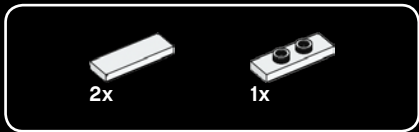

82

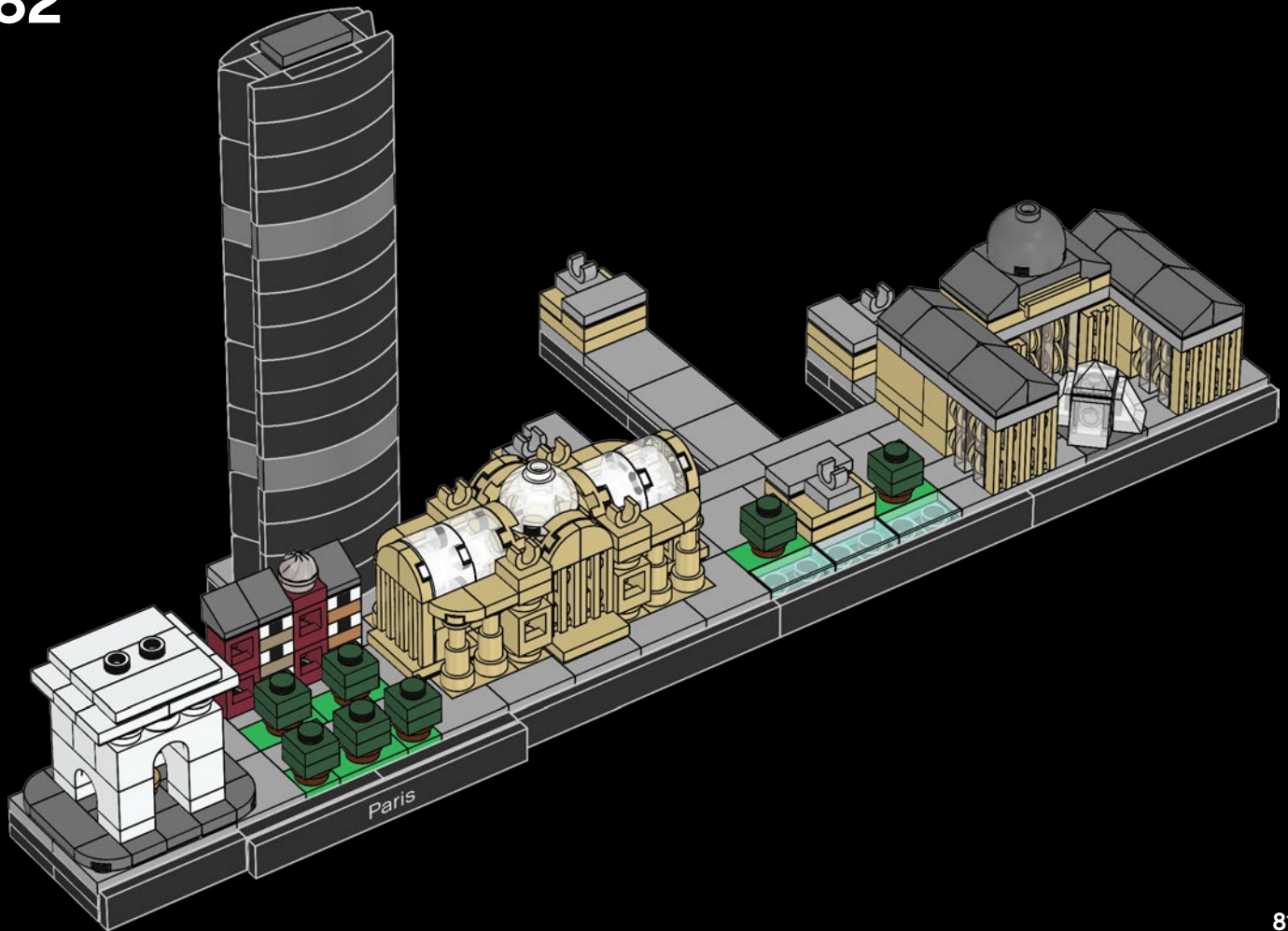

2x

83

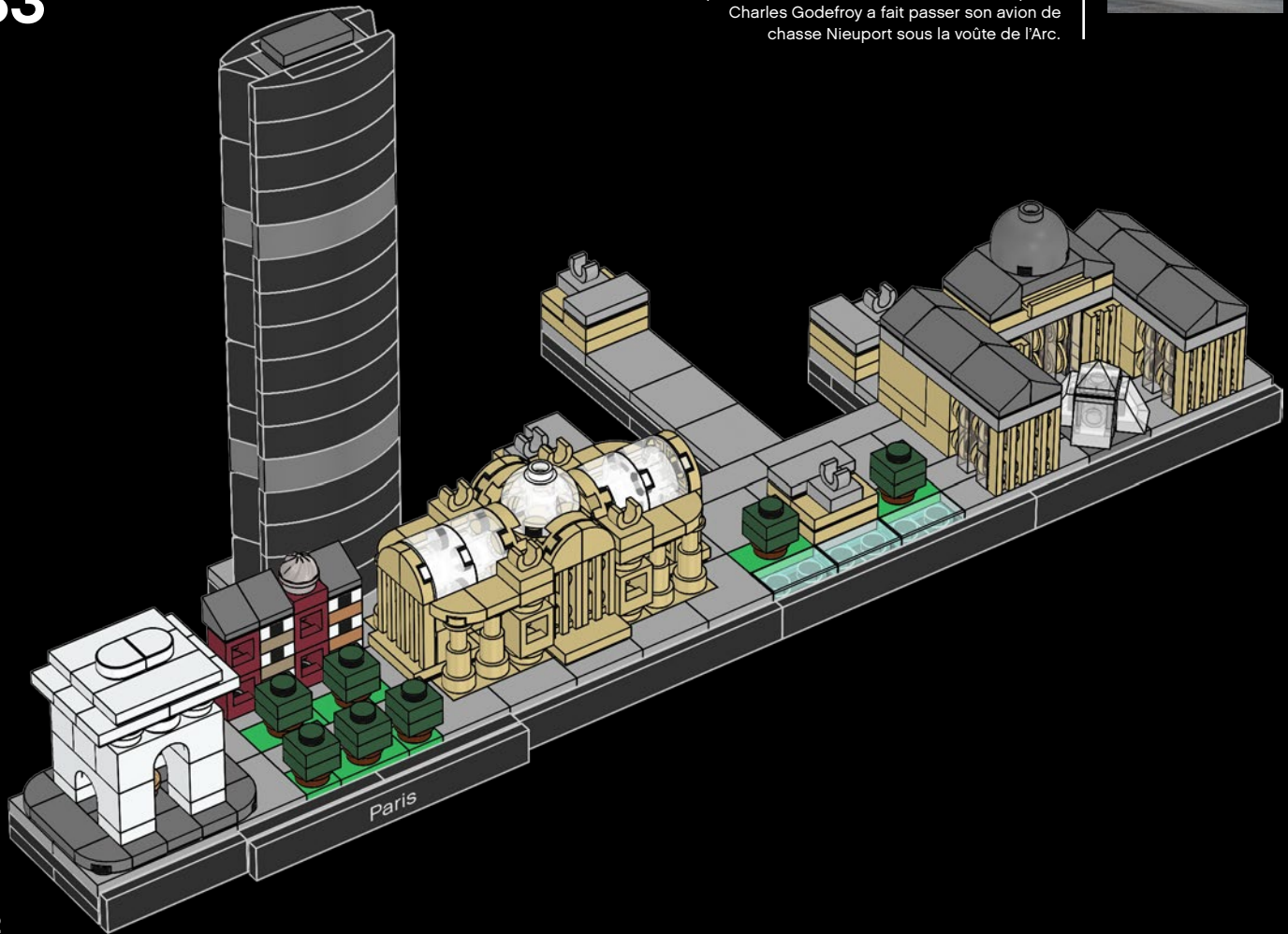

A Victorious Flight

As a salute to the airmen killed during WWI, pilot Charles Godefroy flew his Nieuport fighter plane through the Arch.

Un vol victorieux

Pour rendre hommage aux aviateurs tombés pendant la Première Guerre mondiale, le pilote Charles Godefroy a fait passer son avion de chasse Nieuport sous la voûte de l'Arc.



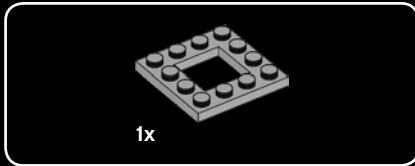
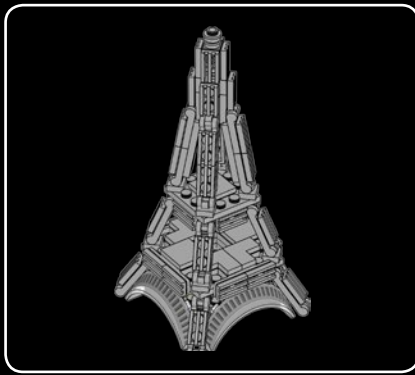

1x

84

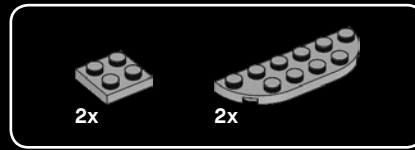
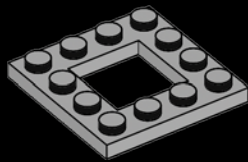

2x

2x

85

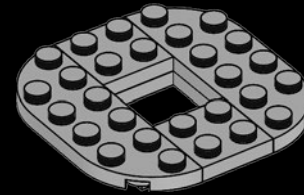

4x

86

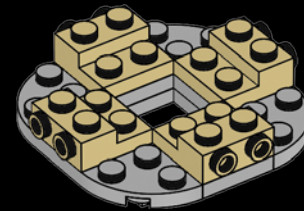



4x

87

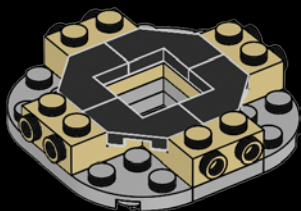

4x

88

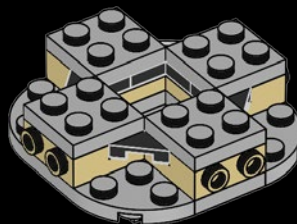



89

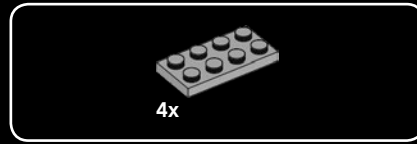
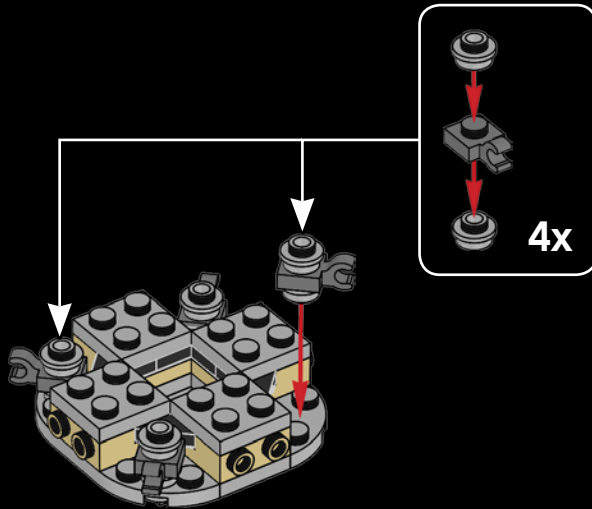

90

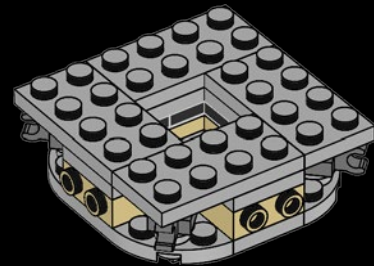

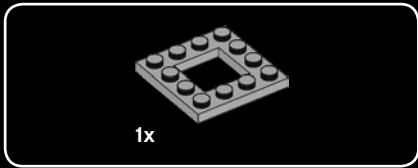

91

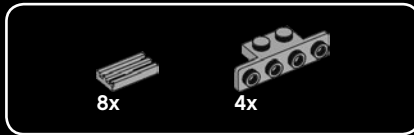
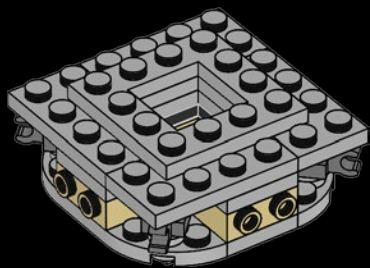

92

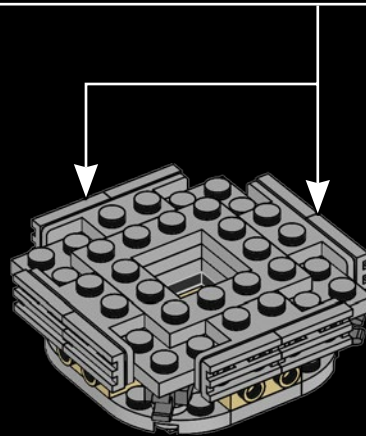
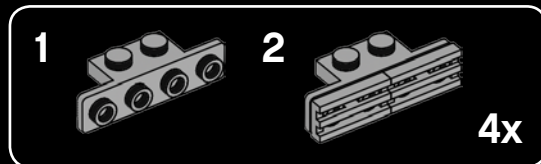

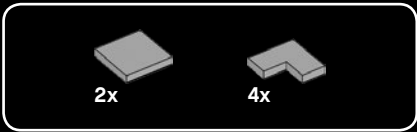

93

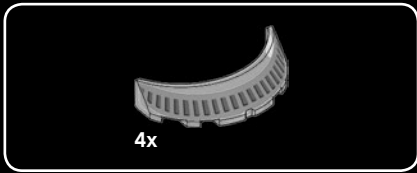
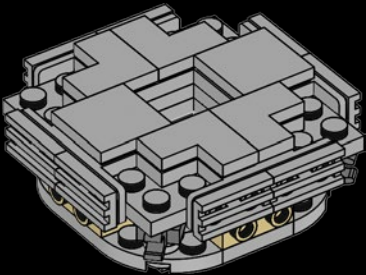

94

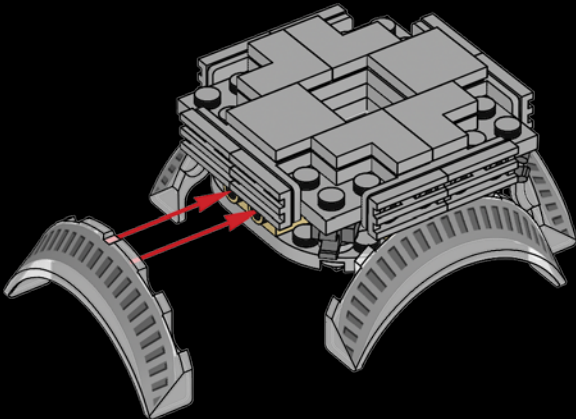

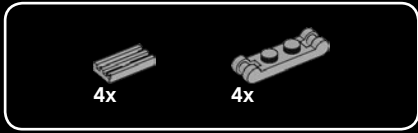

95

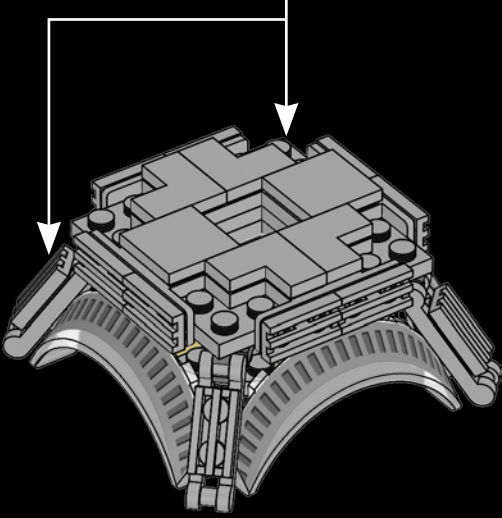
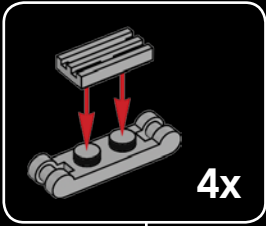

96

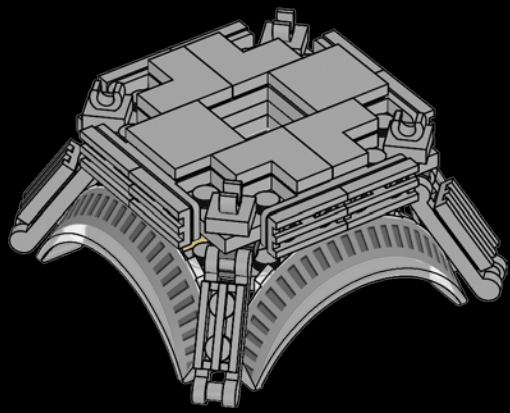

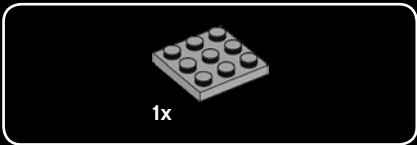
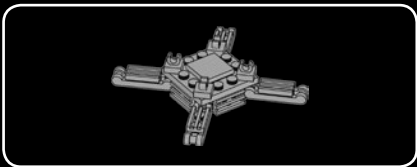

1x

97



2x

98

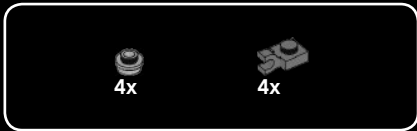
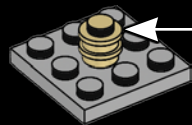

4x

4x

99

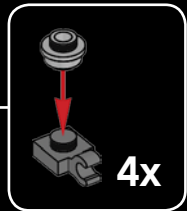
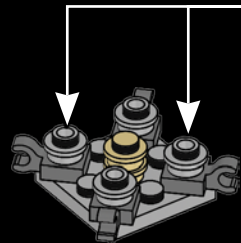

4x

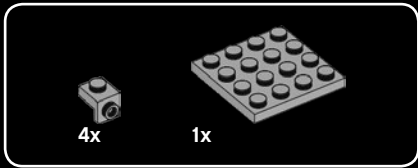

100

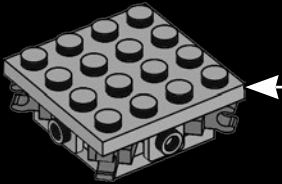
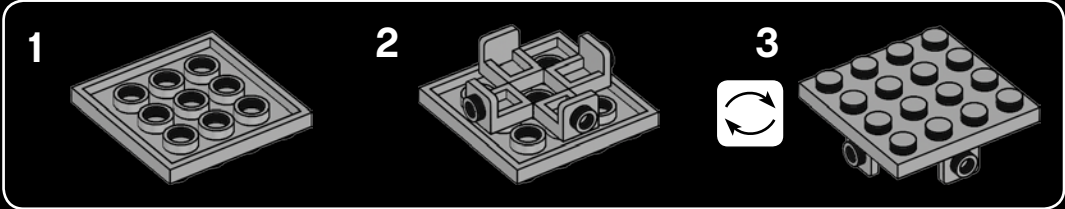

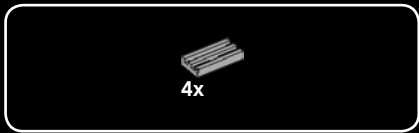

101

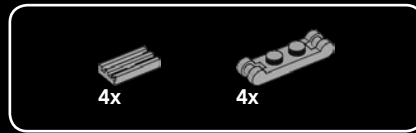
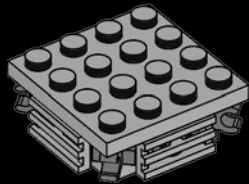

102

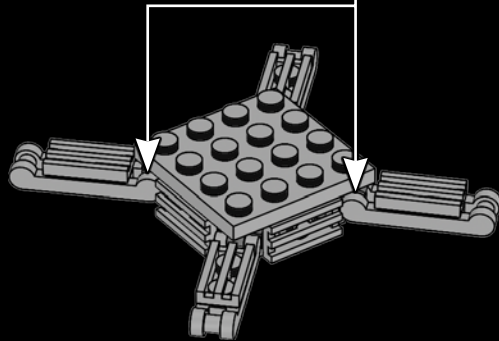
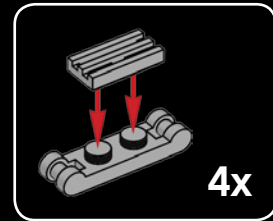

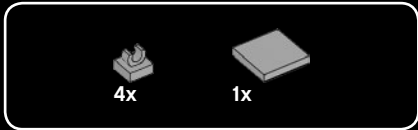

103

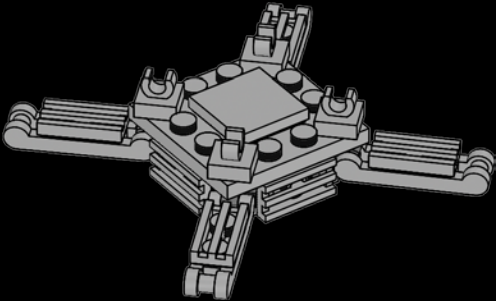

104

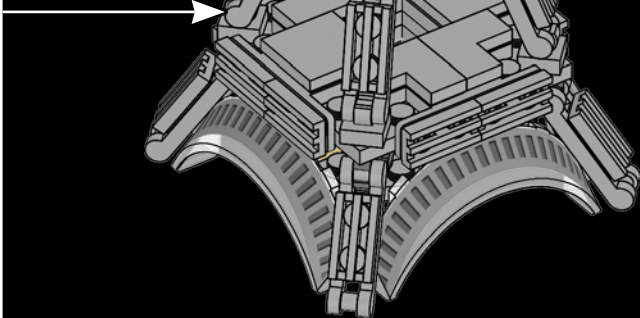

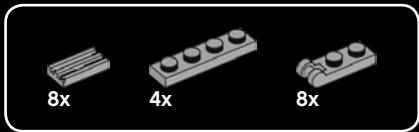

105

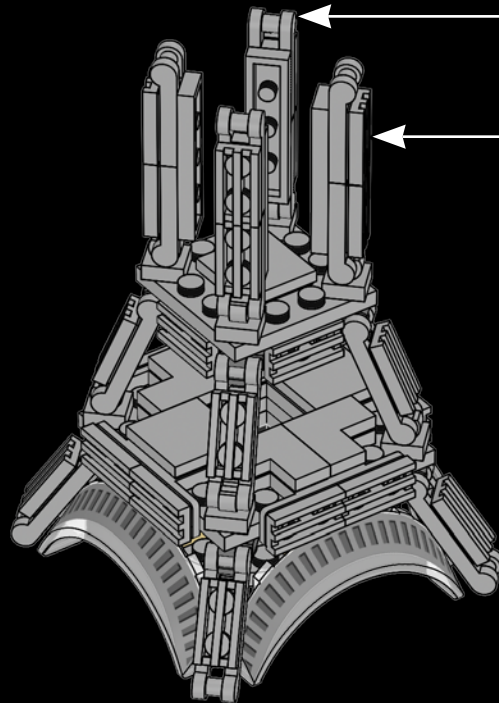
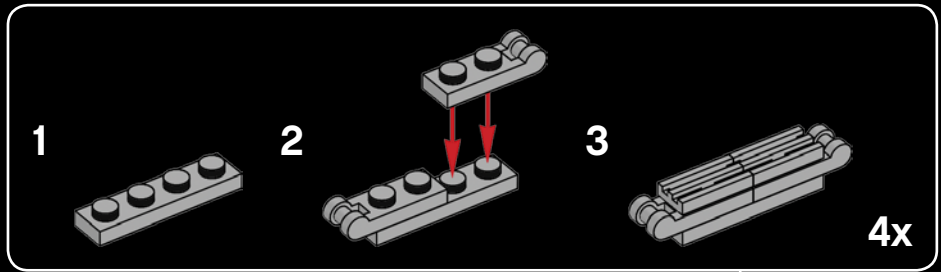



1x



1x

106

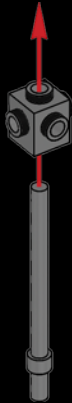

2x

107



1x

108



2x

109



1x

110



2x

111



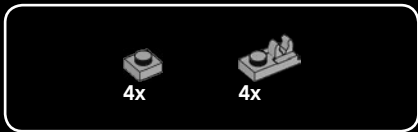

112

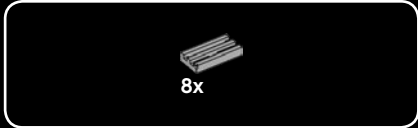
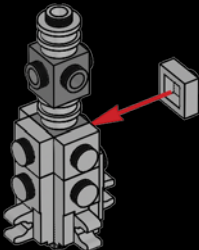

113

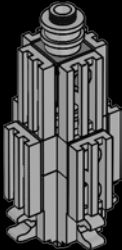

114

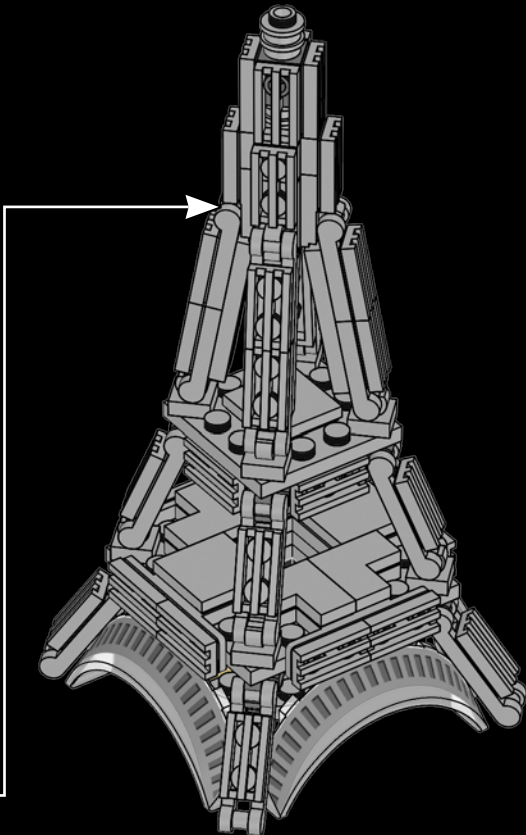

115

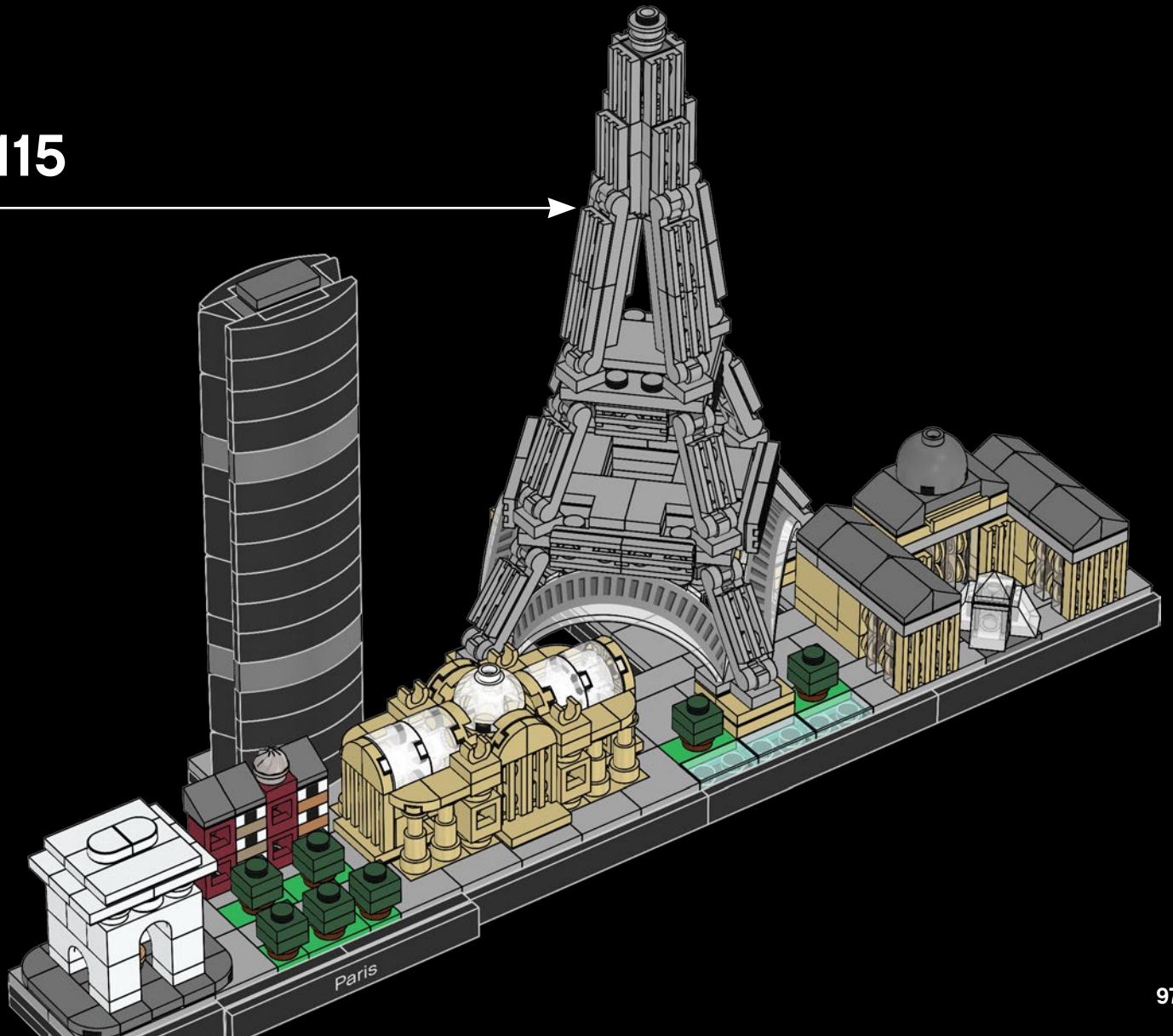

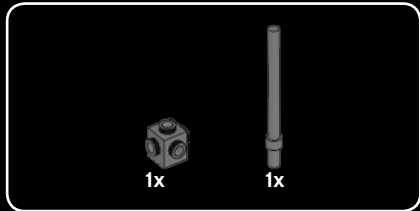
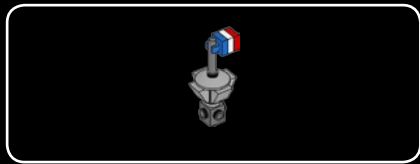

116

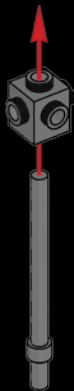

117

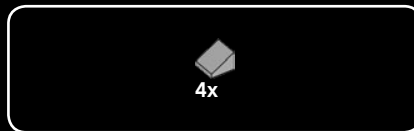

118





119



120

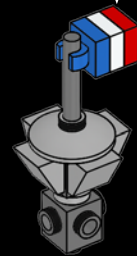
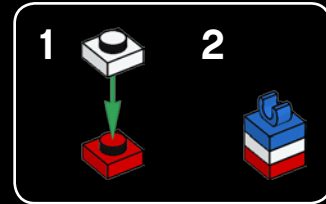

121

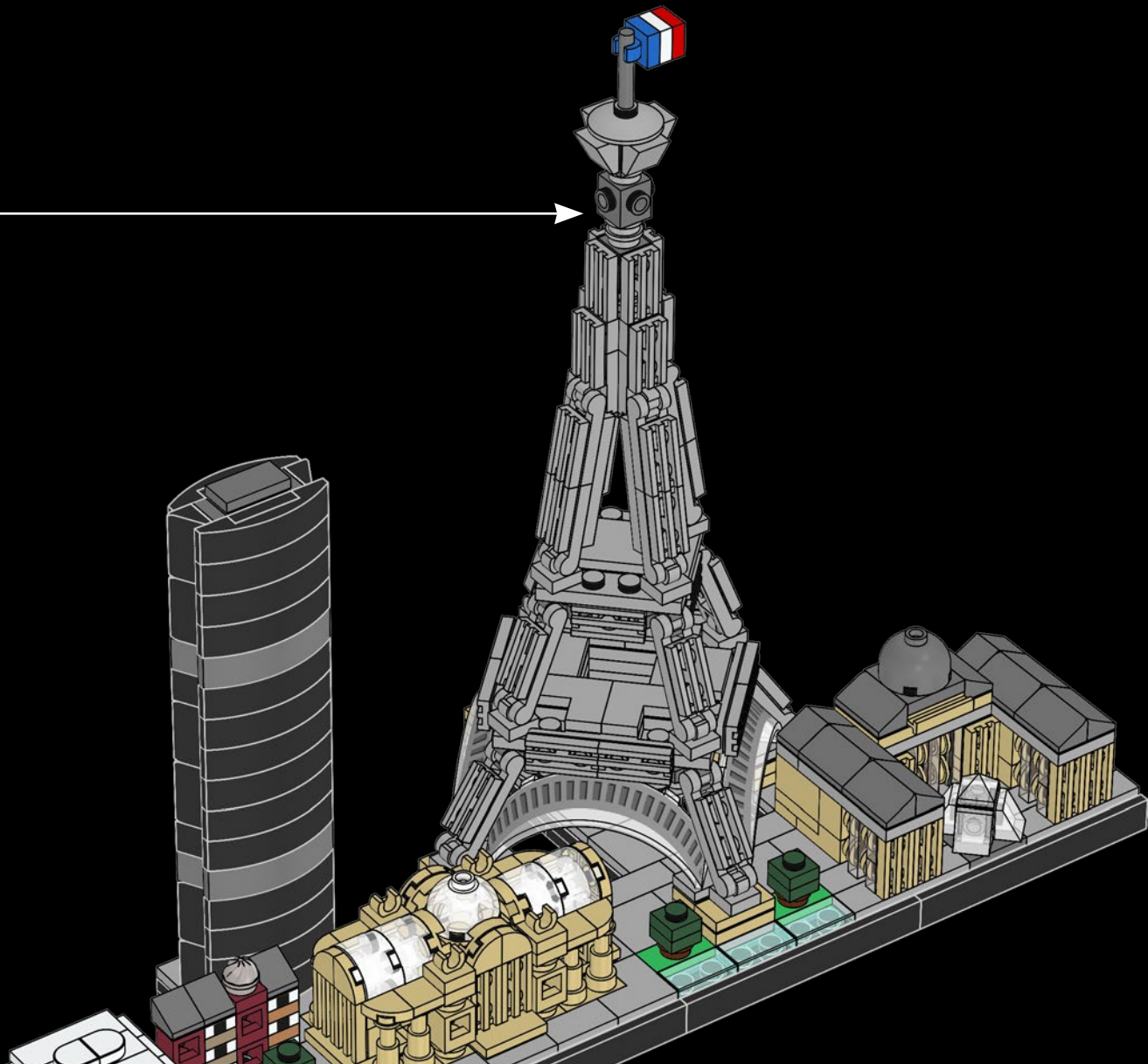

100

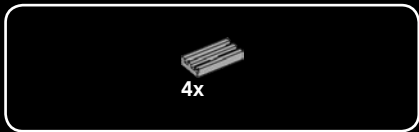

122

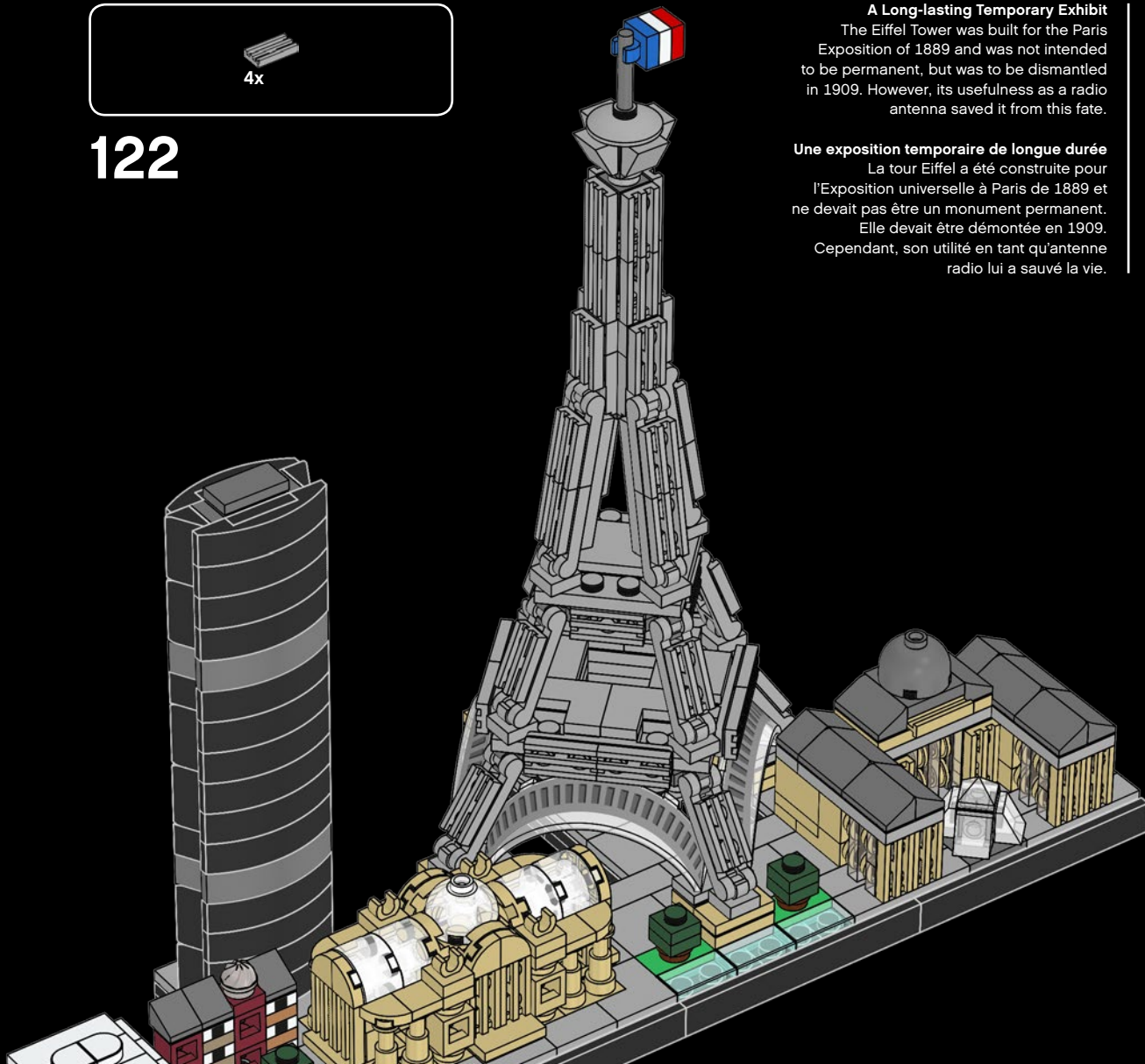

A Long-lasting Temporary Exhibit

The Eiffel Tower was built for the Paris Exposition of 1889 and was not intended to be permanent, but was to be dismantled in 1909. However, its usefulness as a radio antenna saved it from this fate.

Une exposition temporaire de longue durée

La tour Eiffel a été construite pour l'Exposition universelle à Paris de 1889 et ne devait pas être un monument permanent. Elle devait être démontée en 1909. Cependant, son utilité en tant qu'antenne radio lui a sauvé la vie.





LEGO® Architecture – do you like it? Aimez-vous LEGO® Architecture ?

The LEGO Group would like your opinion on the new product you have just purchased. Your feedback will help shape the future development of this product series. Please visit:

Le groupe LEGO aimerait connaître votre opinion sur le produit que vous venez d'acheter. Vos commentaires nous aideront à concevoir les futurs produits de cette gamme. Veuillez visiter :

[LEGO.com/productfeedback](https://www.lego.com/productfeedback)

By completing our short feedback survey, you will be automatically entered into a drawing to win a LEGO® prize.

En complétant cette courte enquête sur le produit, vous participerez automatiquement à un tirage au sort pour gagner un prix LEGO®.

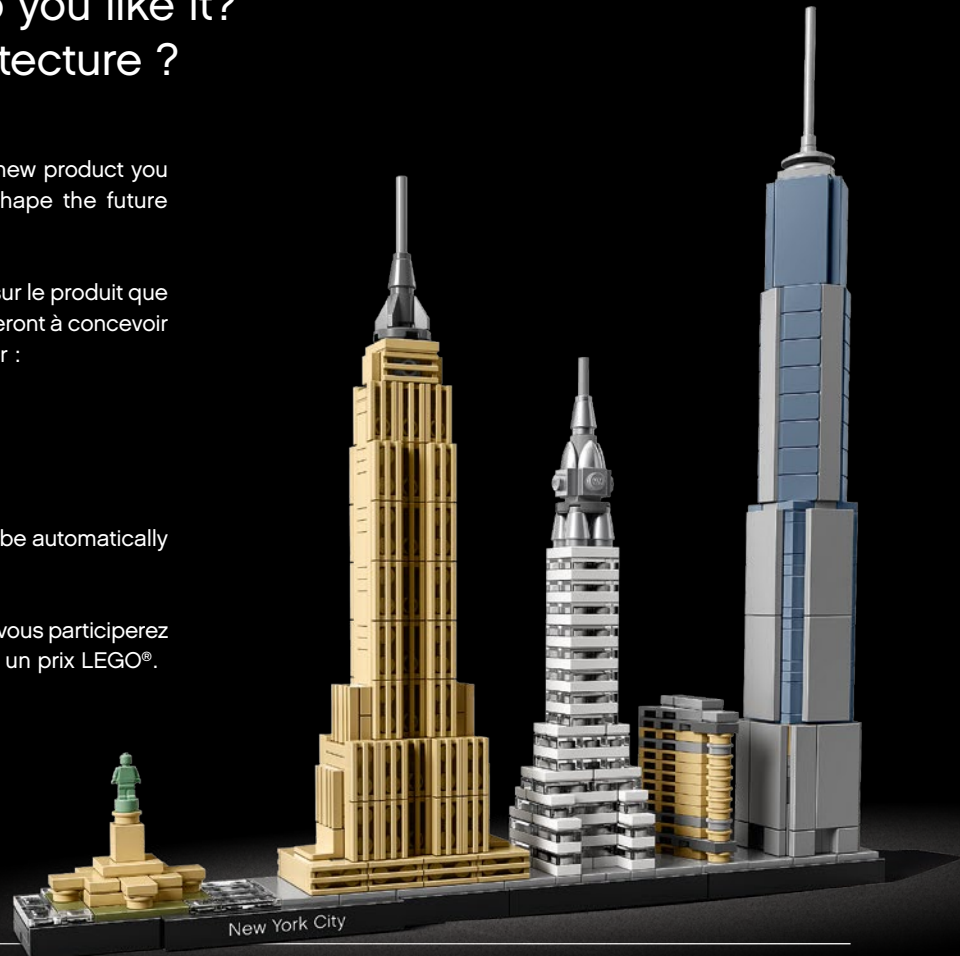

Terms & Conditions apply.
Offre soumise à conditions.

LEGO® Architecture

The LEGO® Architecture series creatively captures the essence of many of the world's most iconic landmarks while giving you an enjoyable and engaging LEGO building experience.

Whether your interest is in travel, design, history or architecture, these sets are a physical memento of a great trip abroad, a famous building you know well, or a city you still dream of visiting.



Every LEGO Architecture set is designed to be displayed. Much more than just a photo, building and displaying your model on your desk, in the bookcase or on the shelf, lets you be transported every time you admire the view.

La gamme LEGO® Architecture capture de manière créative l'essence d'une multitude de monuments comptant parmi les plus emblématiques du monde entier, tout en offrant une expérience de construction LEGO agréable et amusante.

Que vous soyez passionné(e) de voyages, de design, d'histoire ou d'architecture, ces ensembles feront jaillir chez vous le souvenir d'un voyage mémorable à l'étranger, d'un célèbre

bâtiment que vous connaissez bien ou d'une ville que vous rêvez toujours de visiter.

Chaque ensemble LEGO Architecture est conçu pour être exposé. Bien plus qu'une simple photo, votre modèle construit et exposé sur votre bureau, dans votre bibliothèque ou sur une étagère vous permet de voyager chaque fois que vous posez les yeux dessus.

Follow us on  
Suivez-nous sur

Adam Reed Tucker is the co-developer of the LEGO Architecture product line.

Adam Reed Tucker est le codéveloppeur de la ligne de produits LEGO Architecture.



Celebrate the world of architecture
and collect all the models

Mettez à l'honneur le monde de l'architecture
et collectionnez tous les modèles



21041
Great Wall of China
La Grande Muraille de Chine



21030
United States Capitol Building
Le Capitole des États-Unis



21042
Statue of Liberty
La Statue de la Liberté

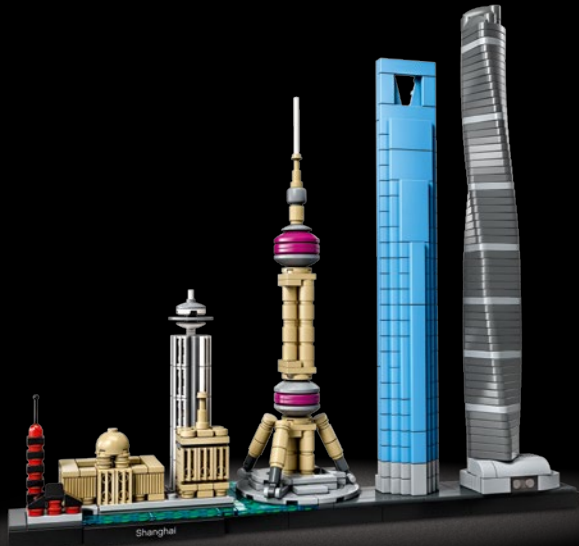

21039
Shanghai



21047
Las Vegas



21034
London
Londres



21028
New York City
New York

References

Références

*Pictures -
Images -*

© GettyImages

Customer Service
Kundenservice
Service Consommateurs
Servicio Al Consumidor
LEGO.com/service or dial

 00800 5346 5555 ;
 1-800-422-5346 ;



1



2



3

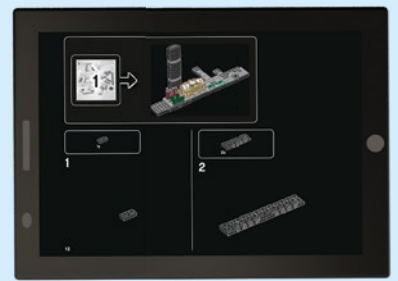



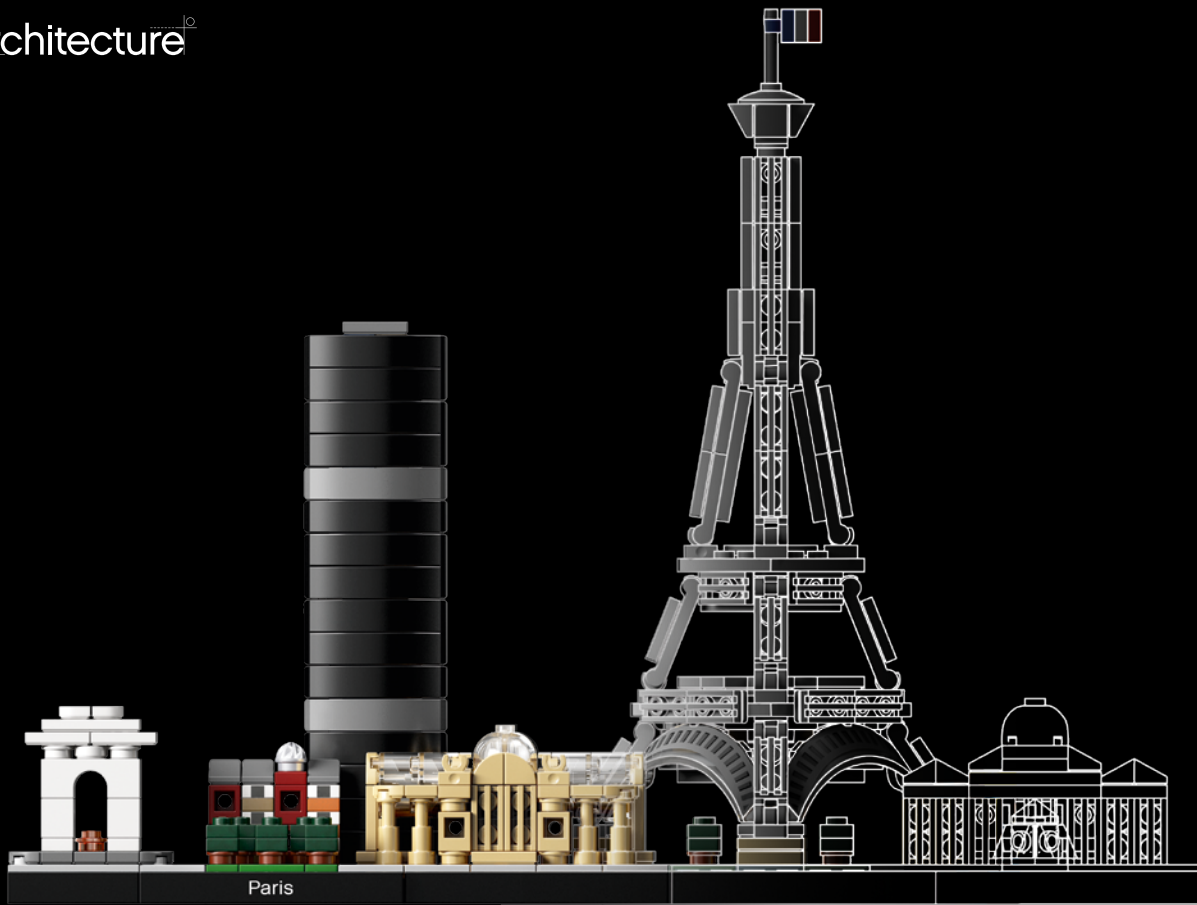

LEGO and the LEGO logo are trademarks of the LEGO Group.
©2019 The LEGO Group. 6281933

© Pyramide du Louvre, architecte I. M. Pei, musée du Louvre.

 [LEGO.com/architecture](https://www.lego.com/architecture)

Follow LEGO® Architecture on

