



MINECRAFT

21127





1

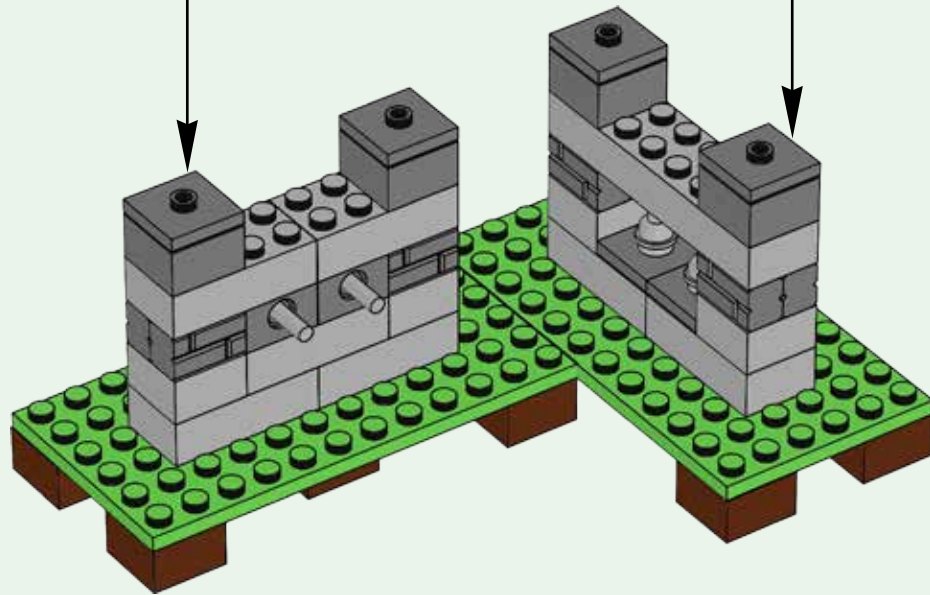
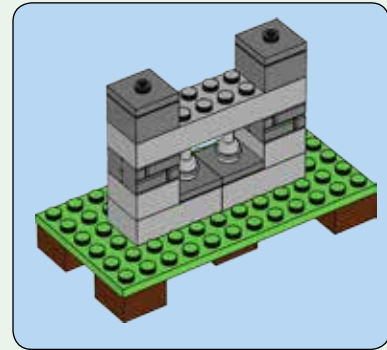
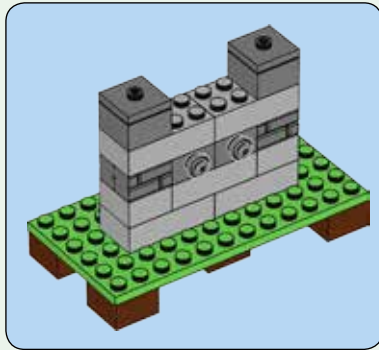

2

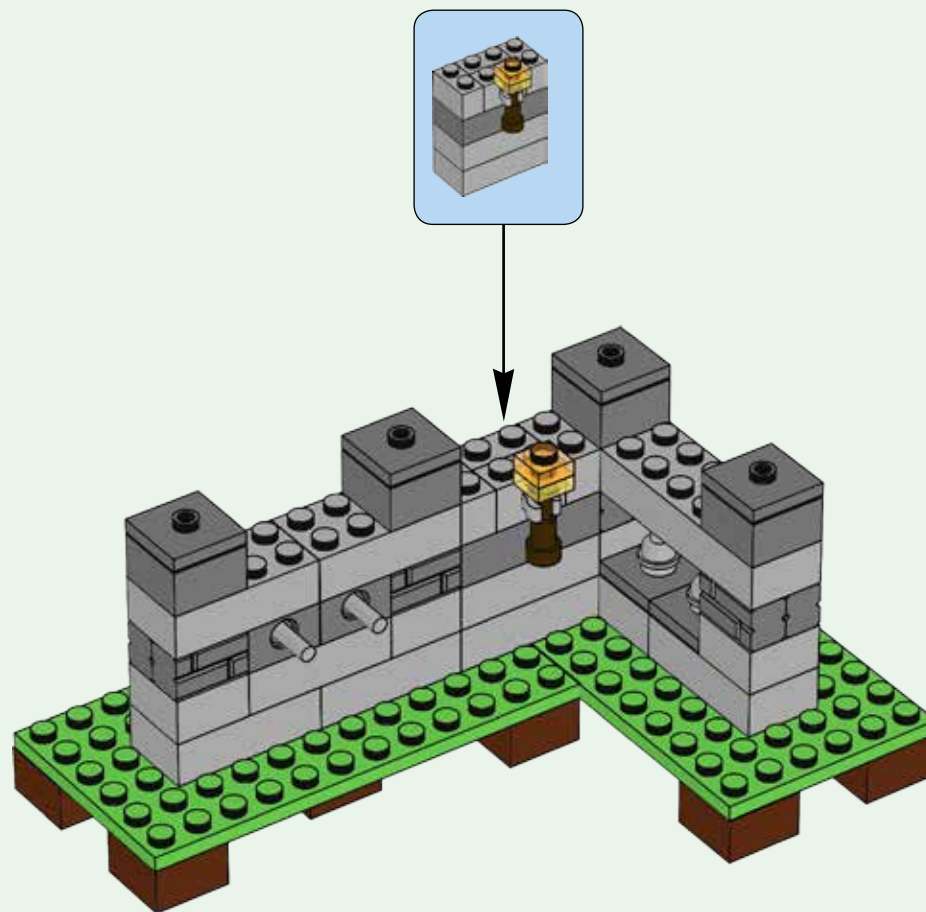

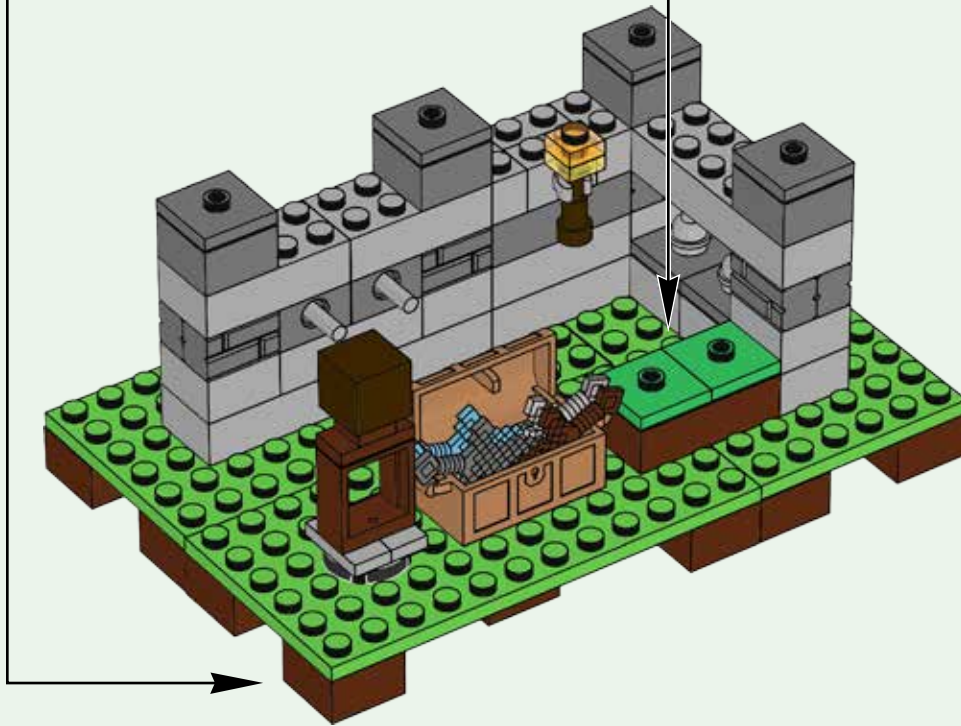
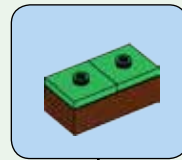
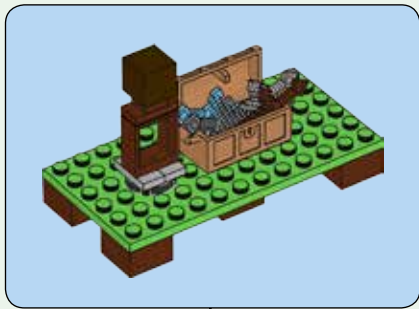

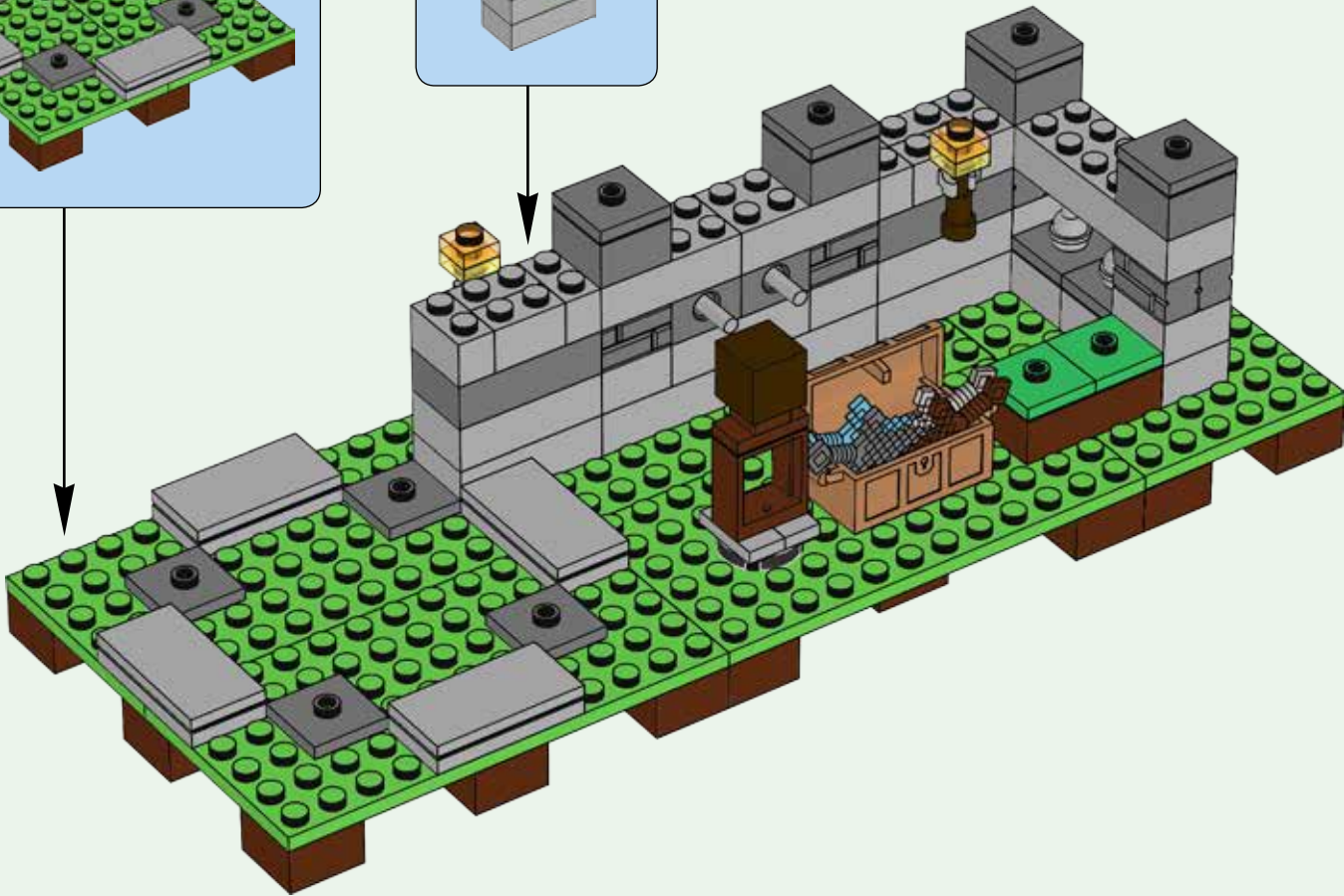
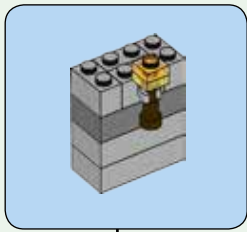
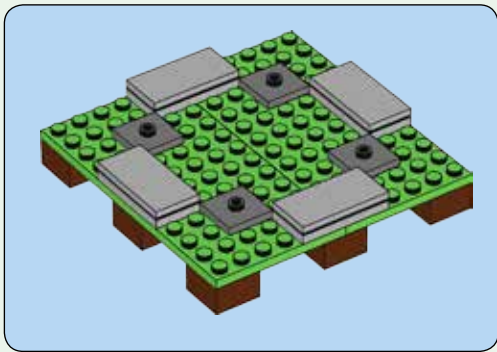

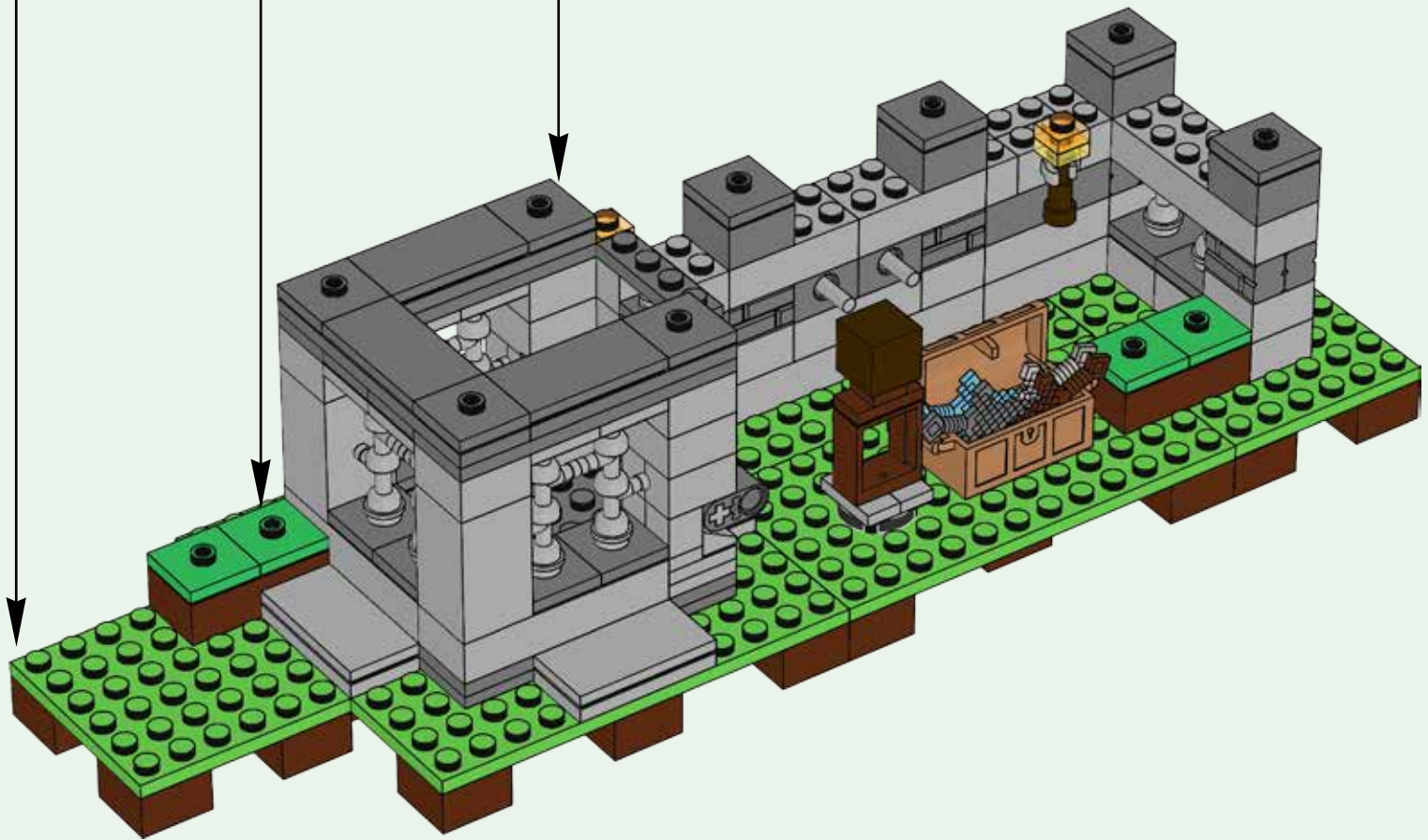
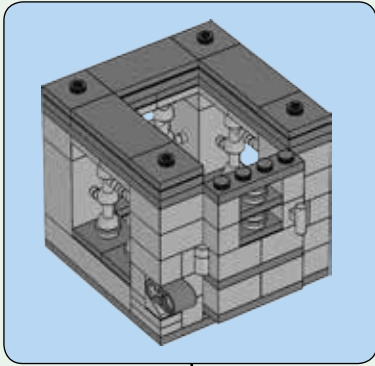
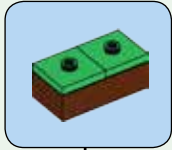
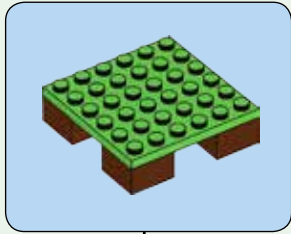

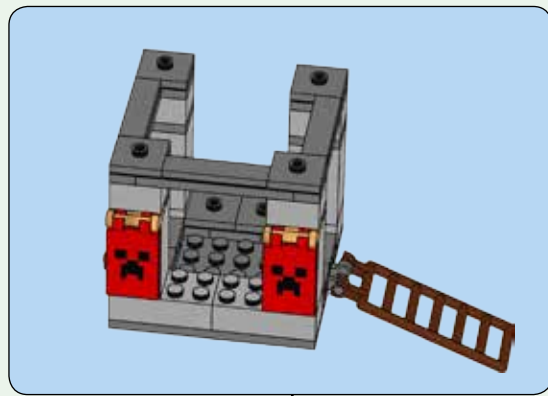

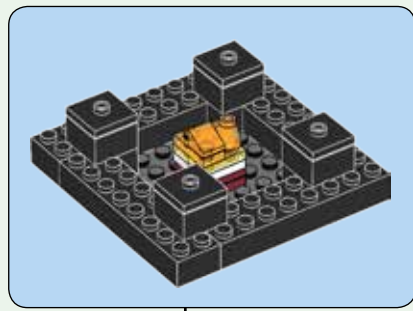
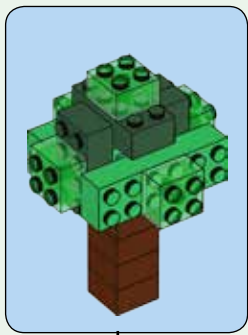



2

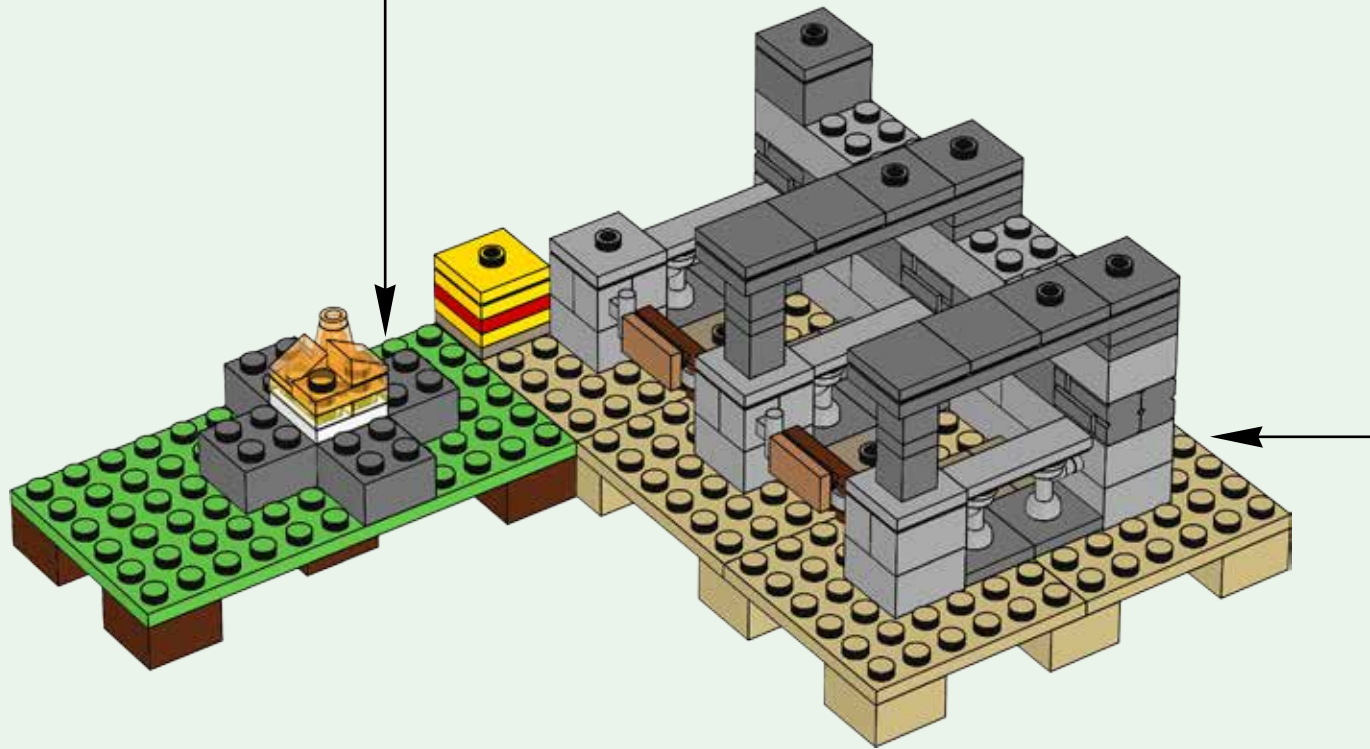
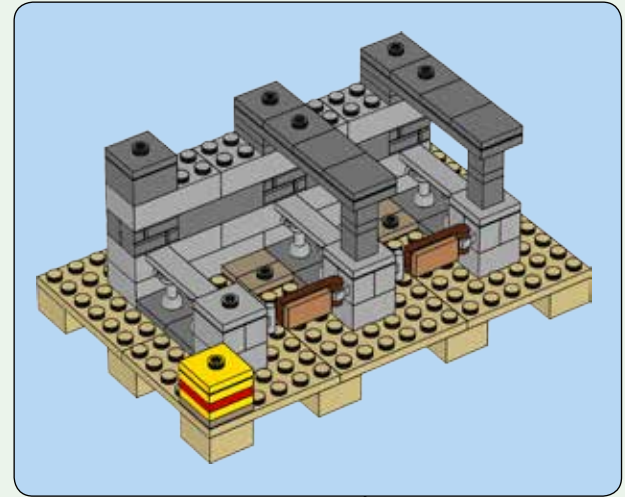
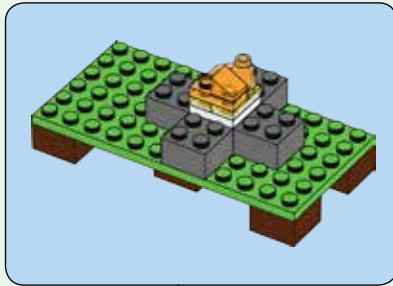

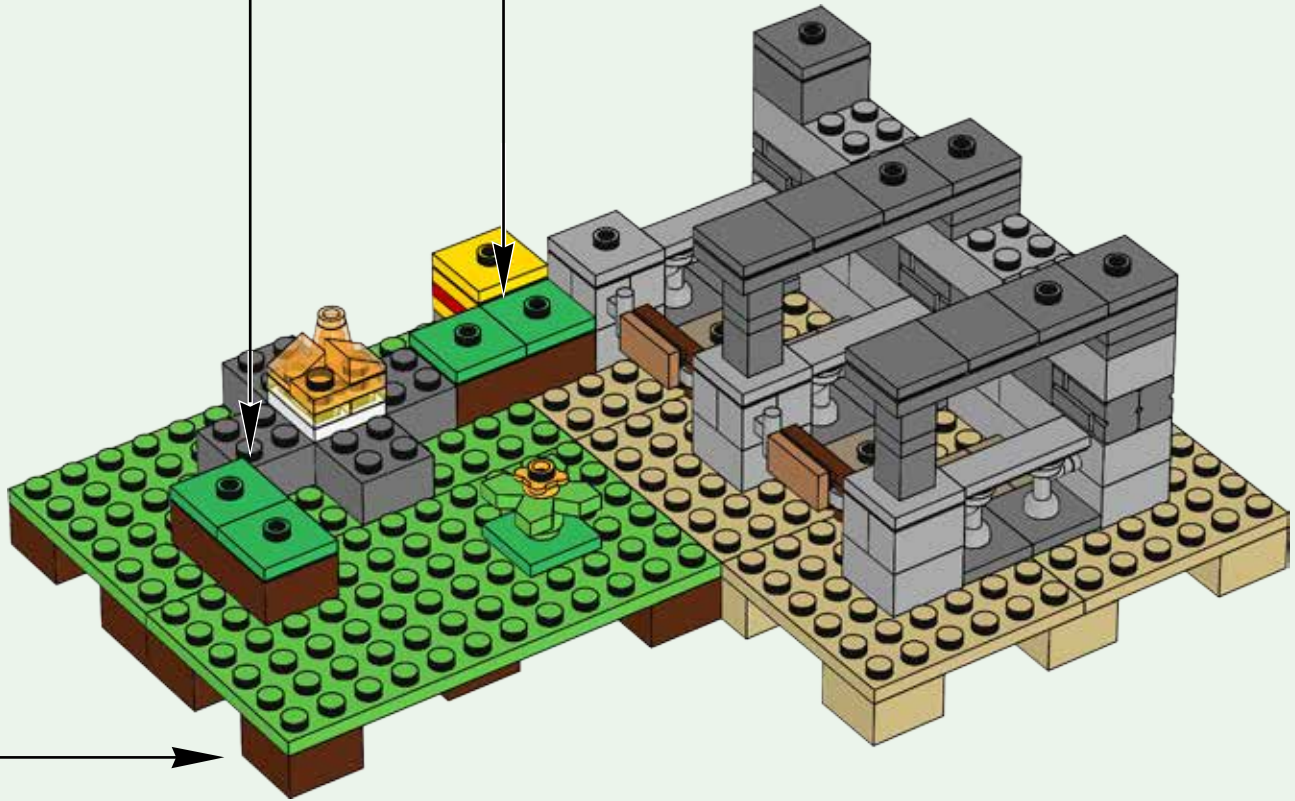
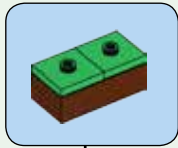
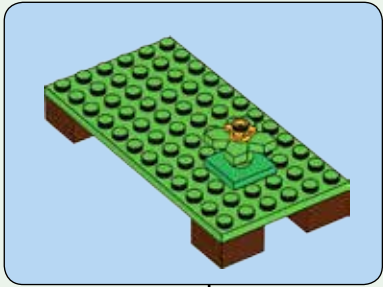

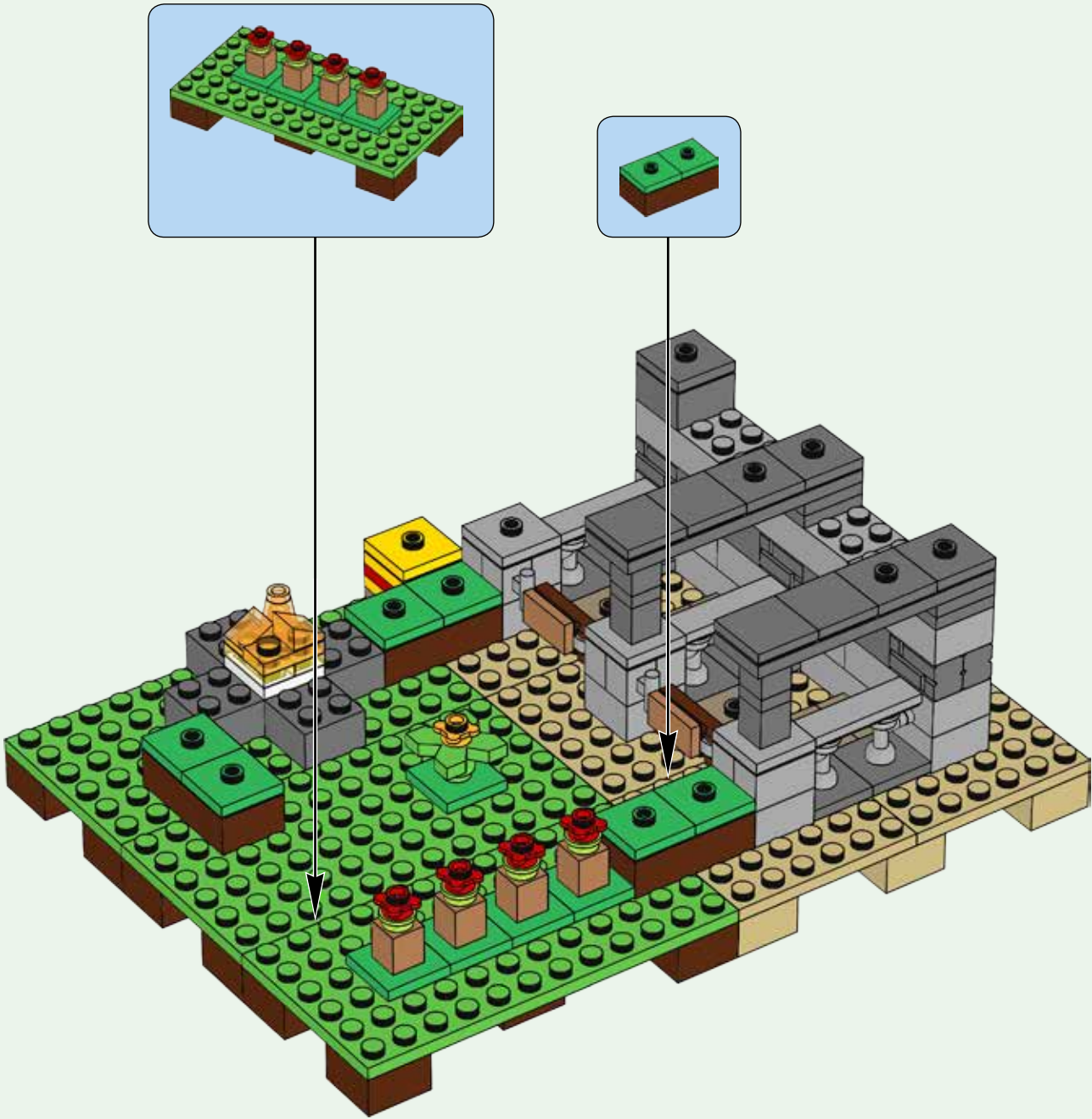

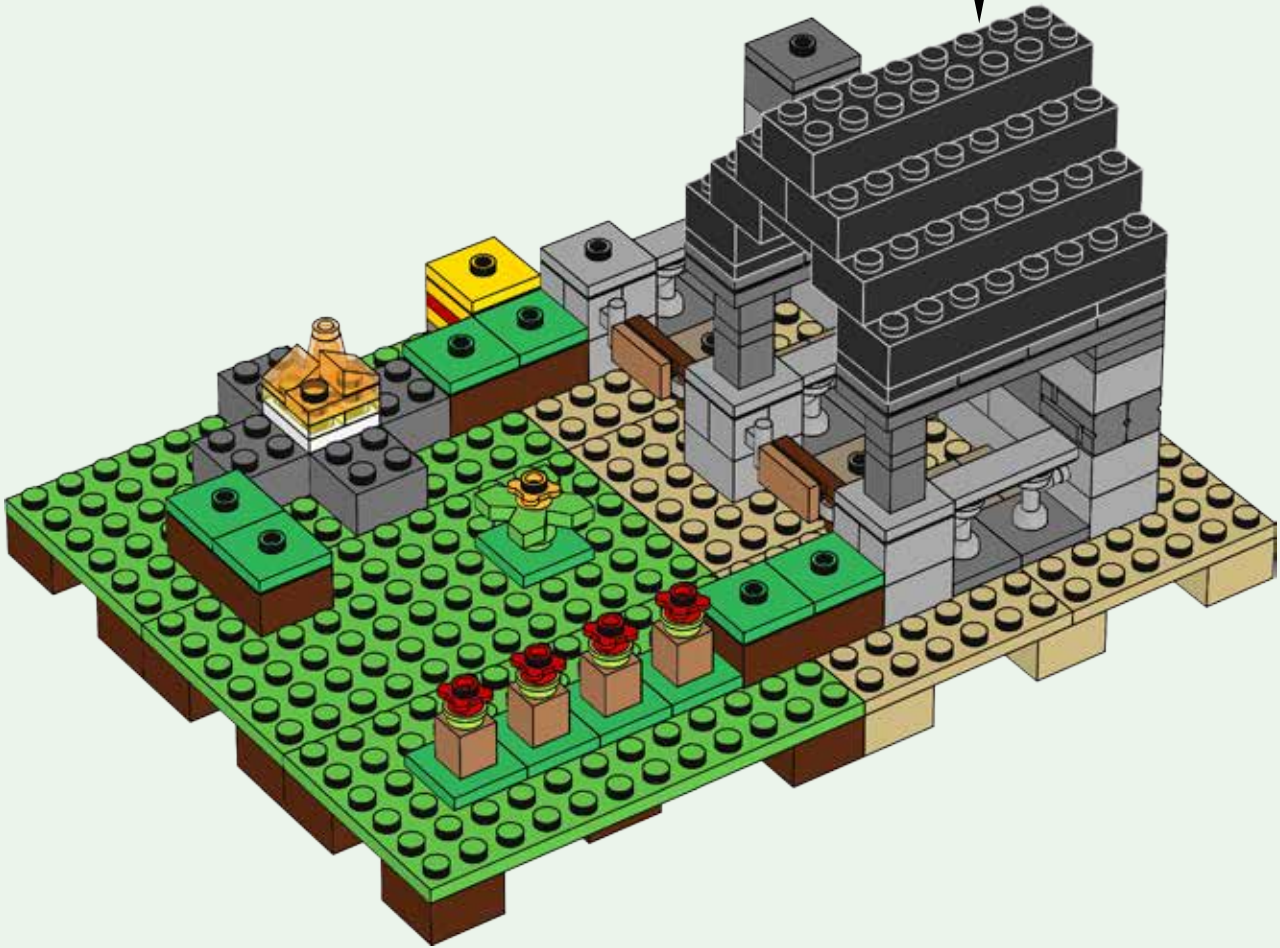
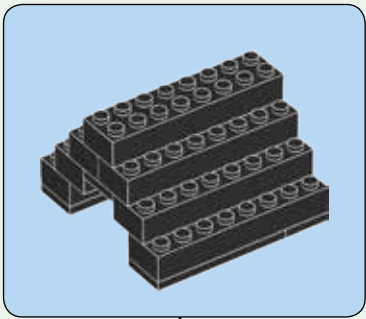



3

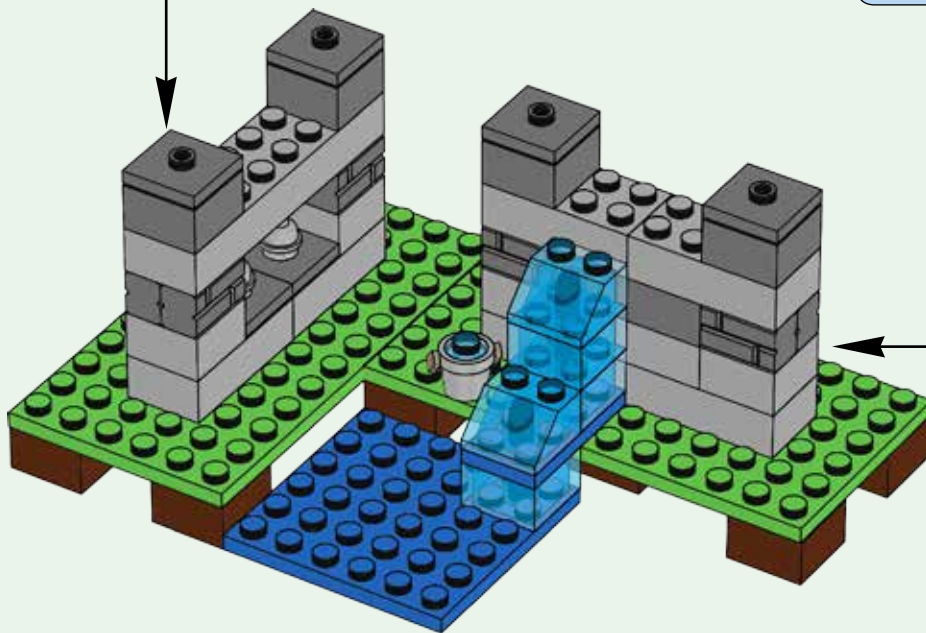
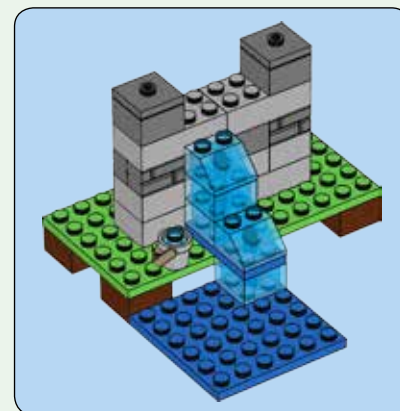
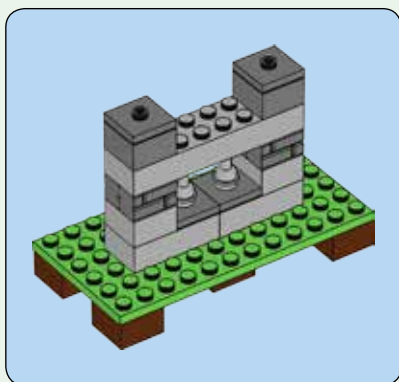

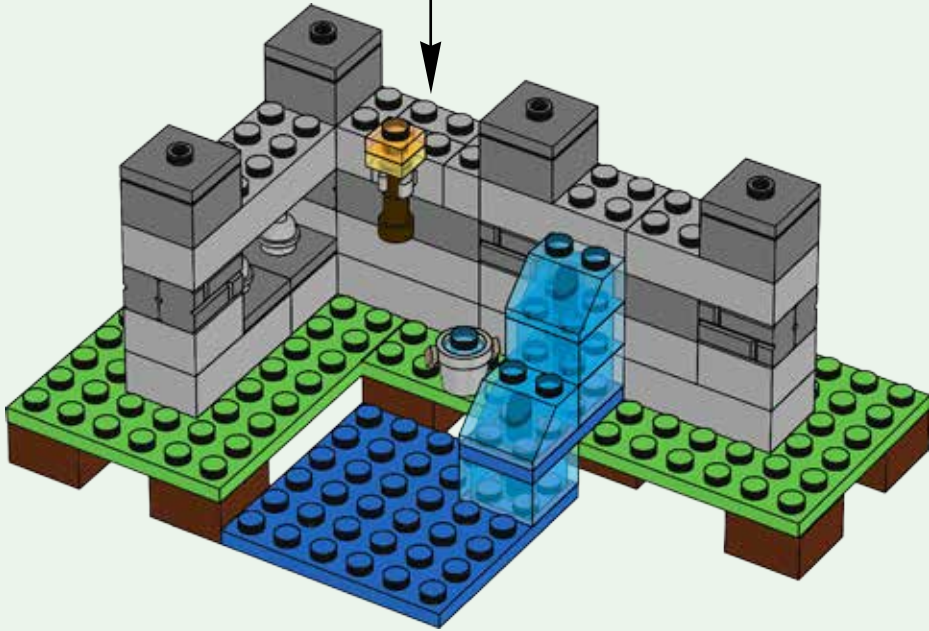
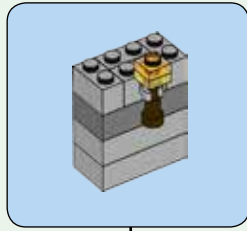

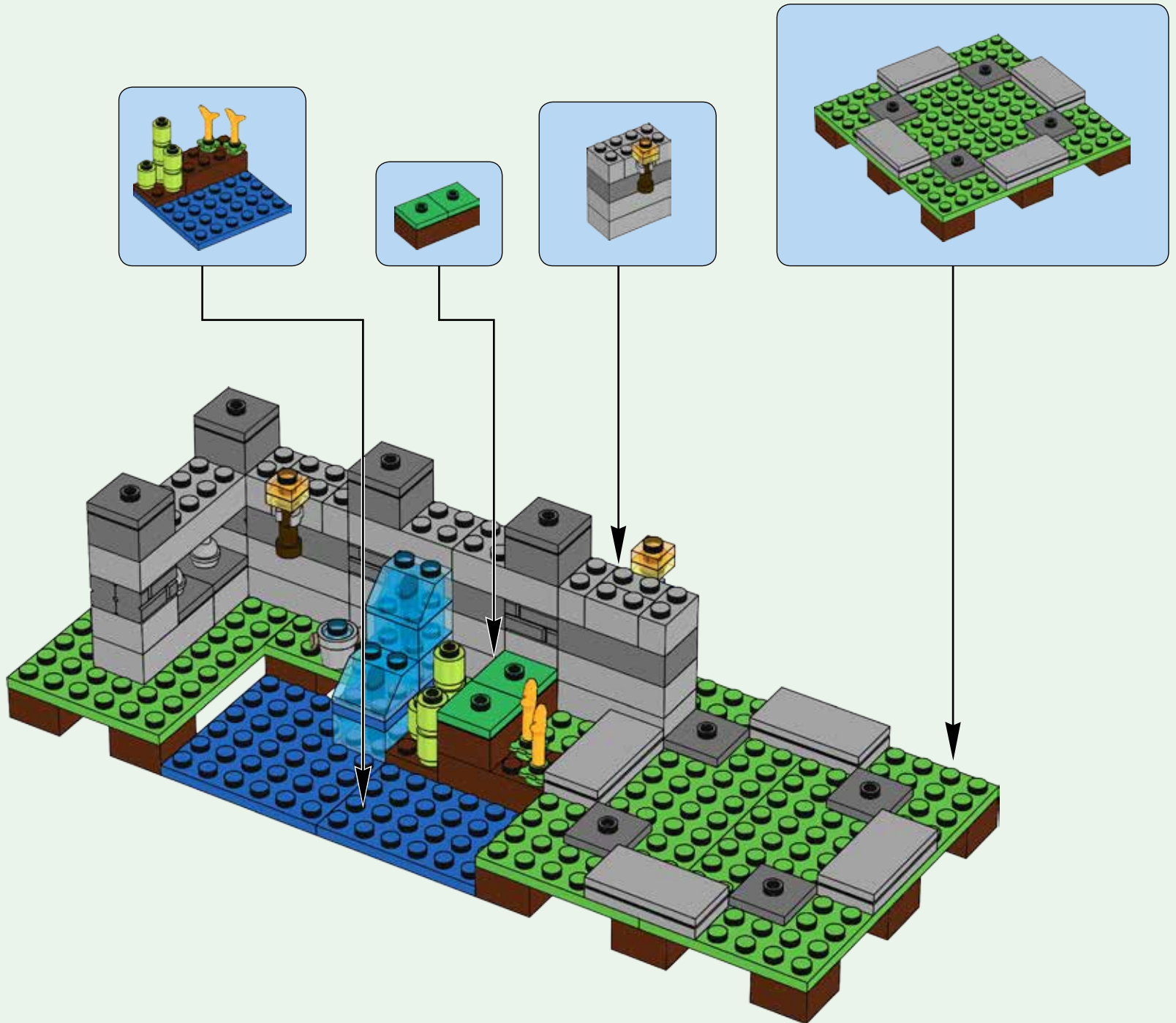

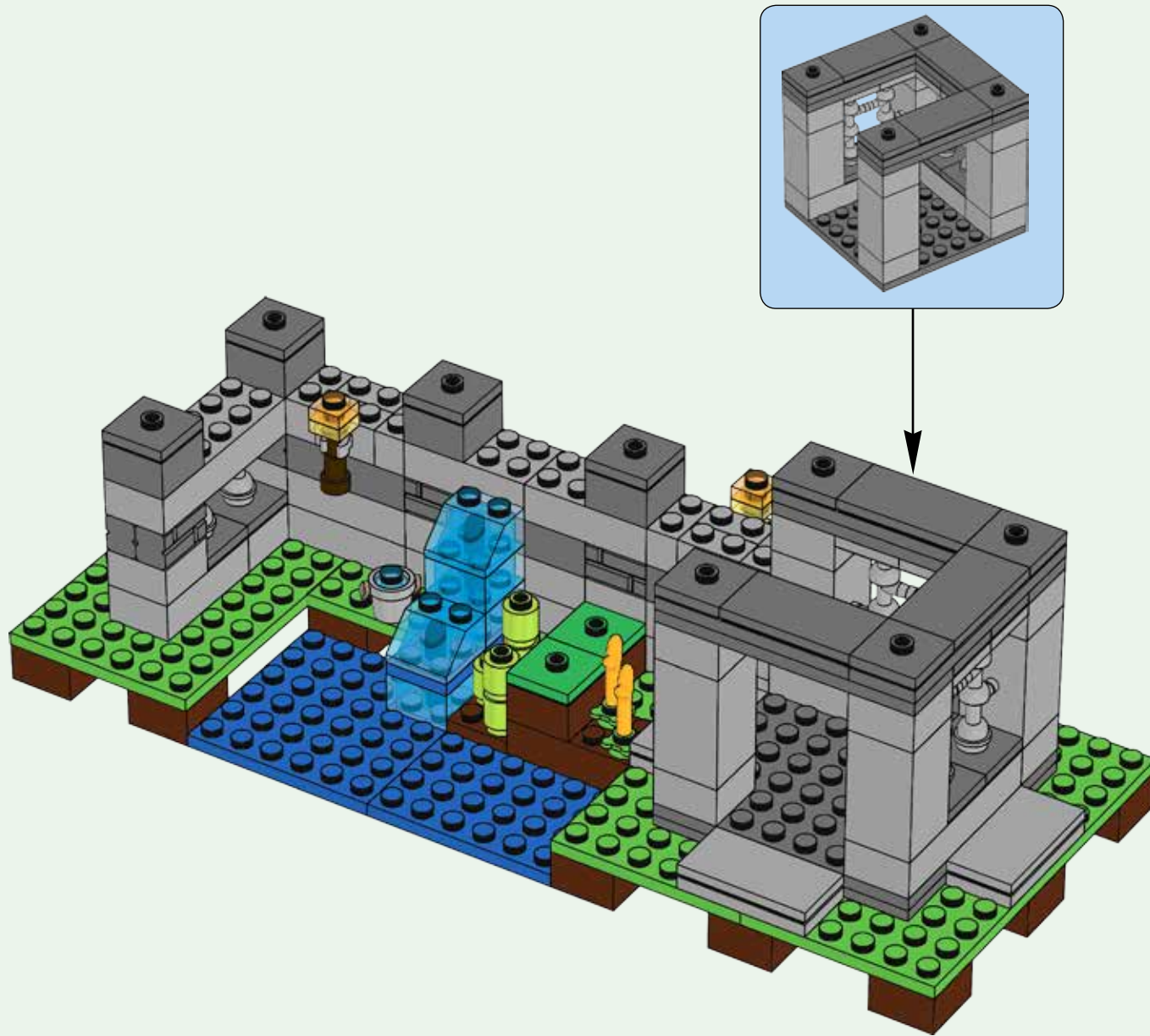

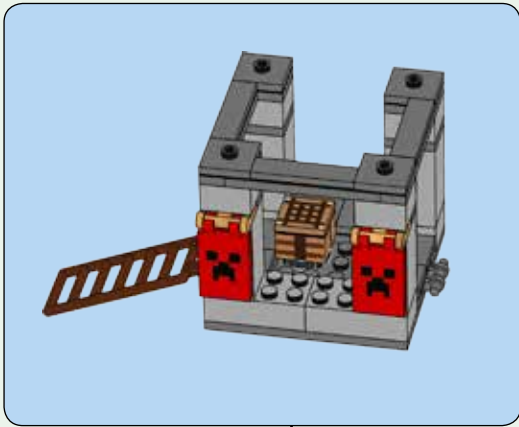

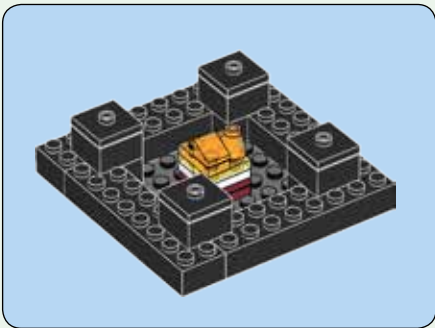

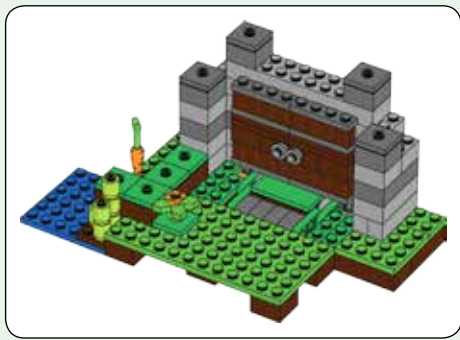

4

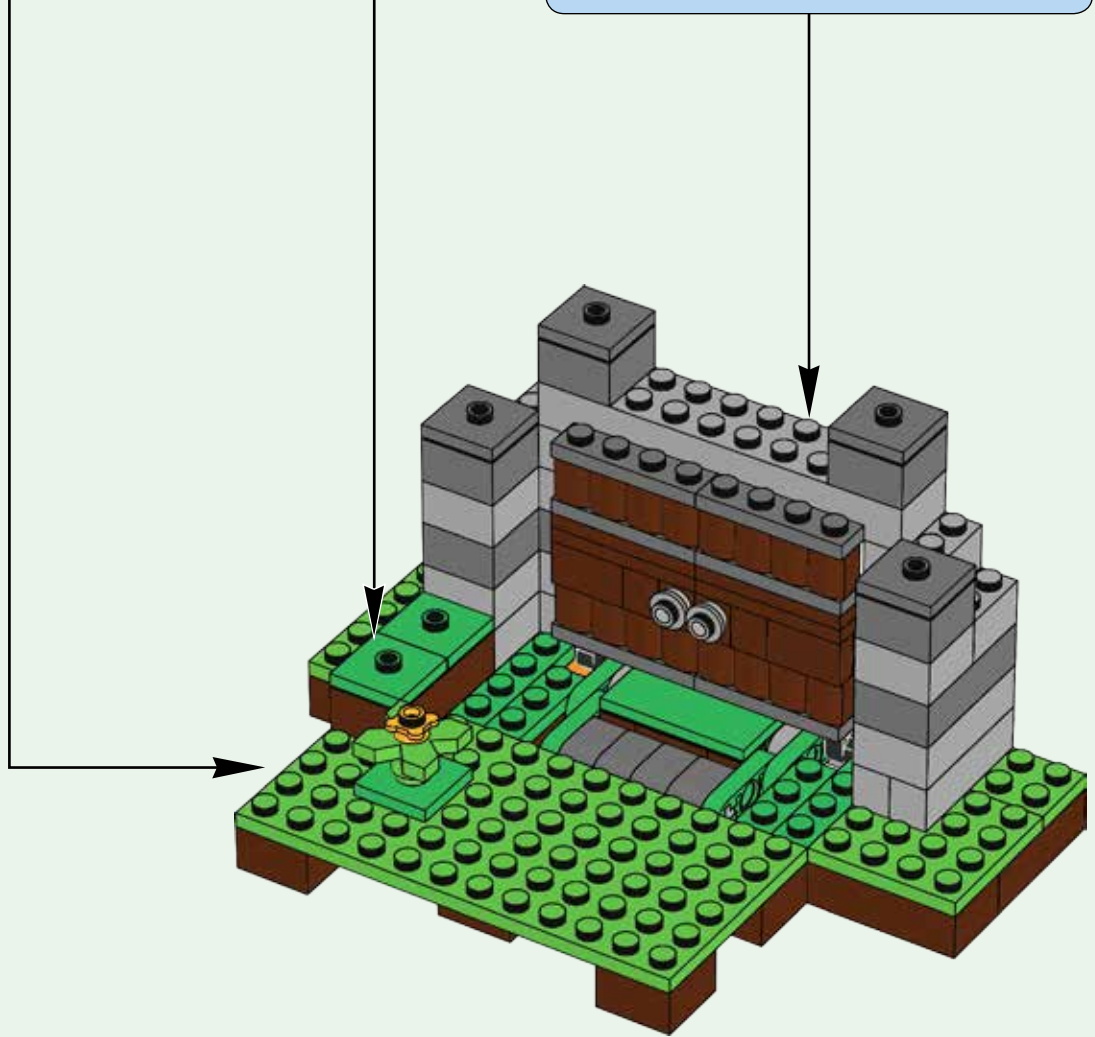
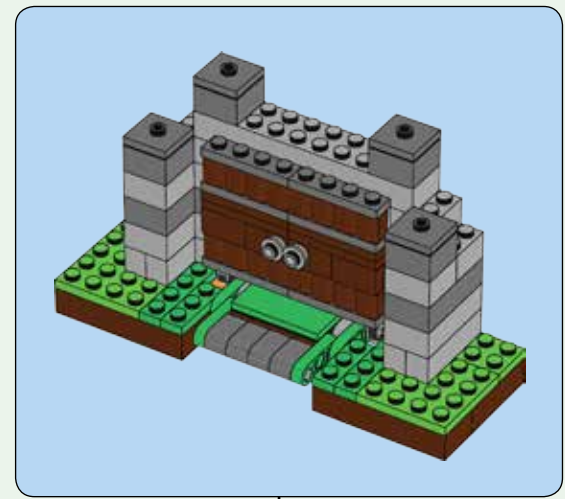
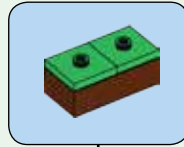
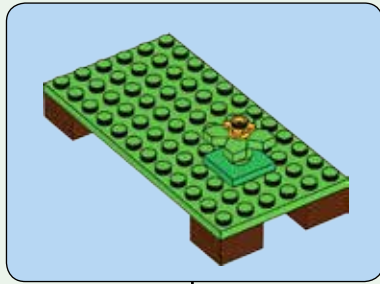

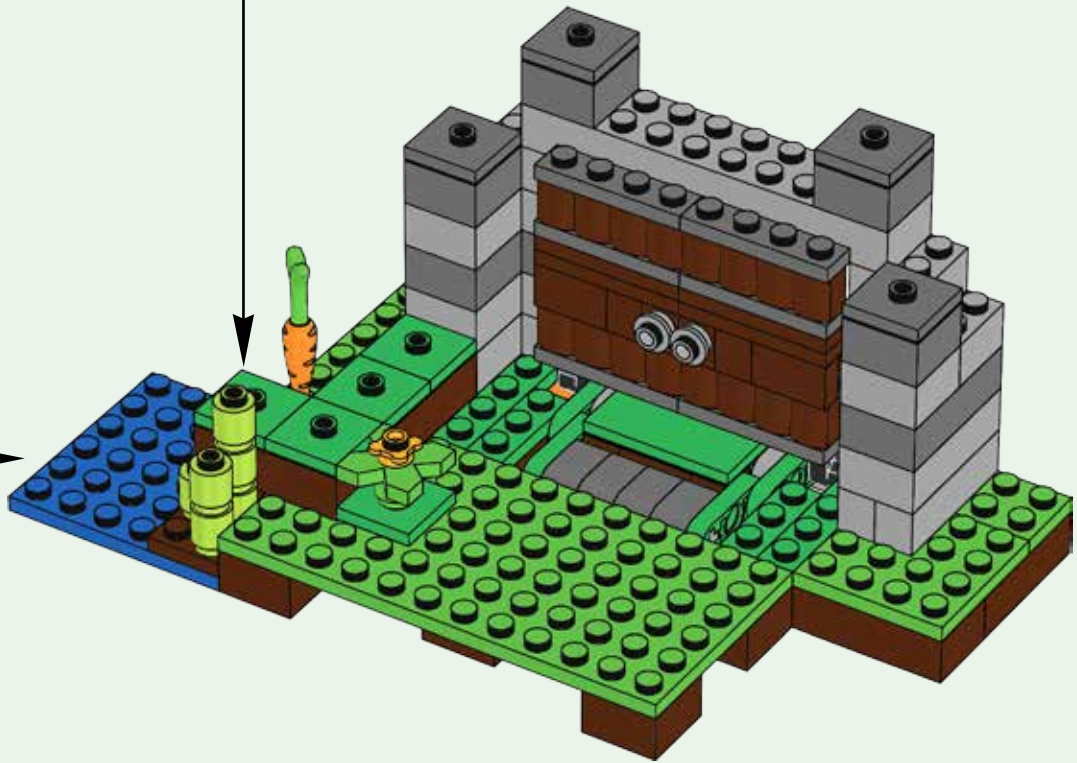

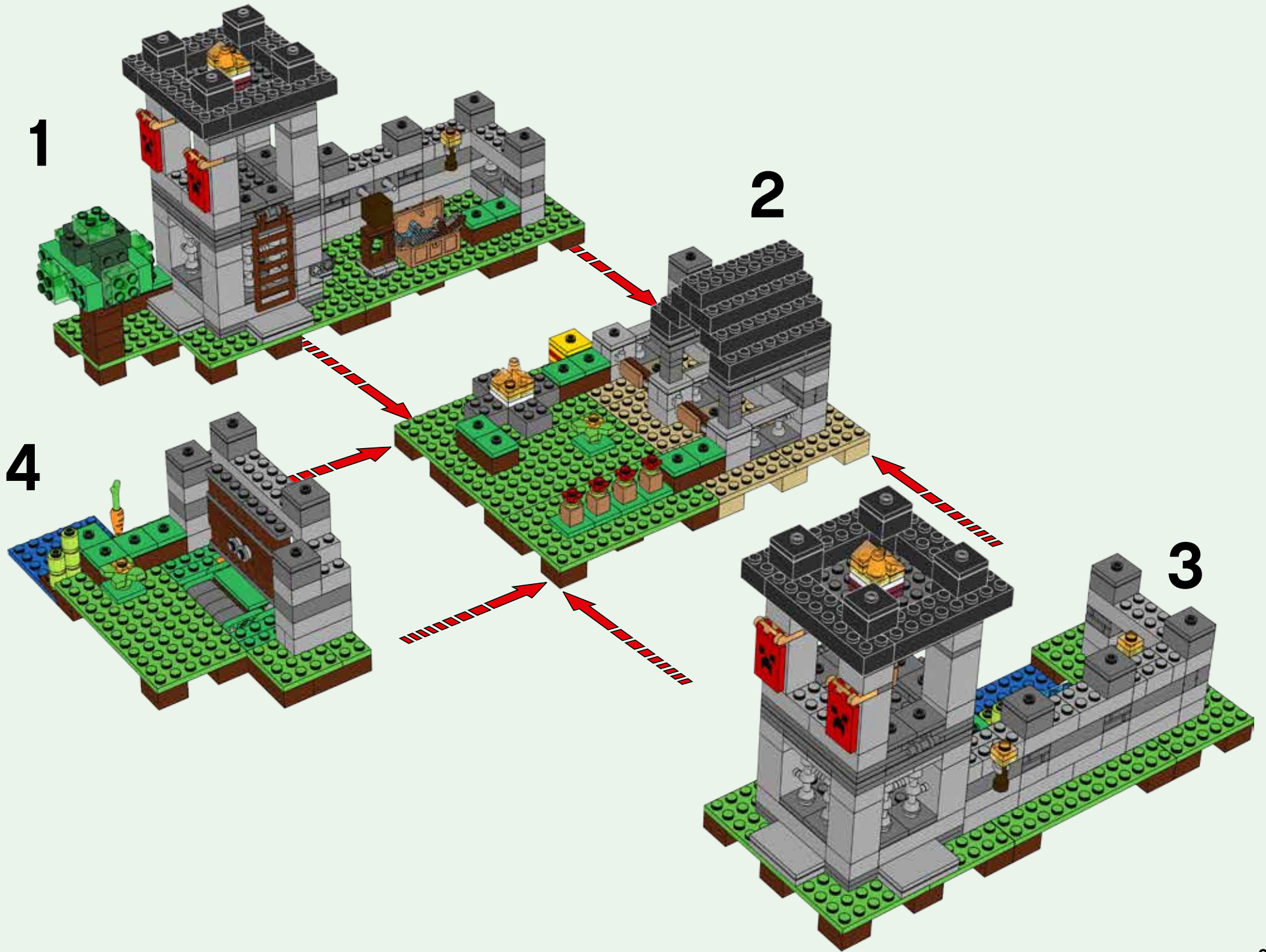



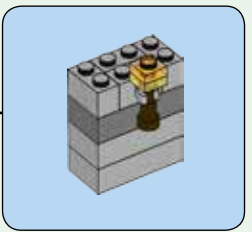
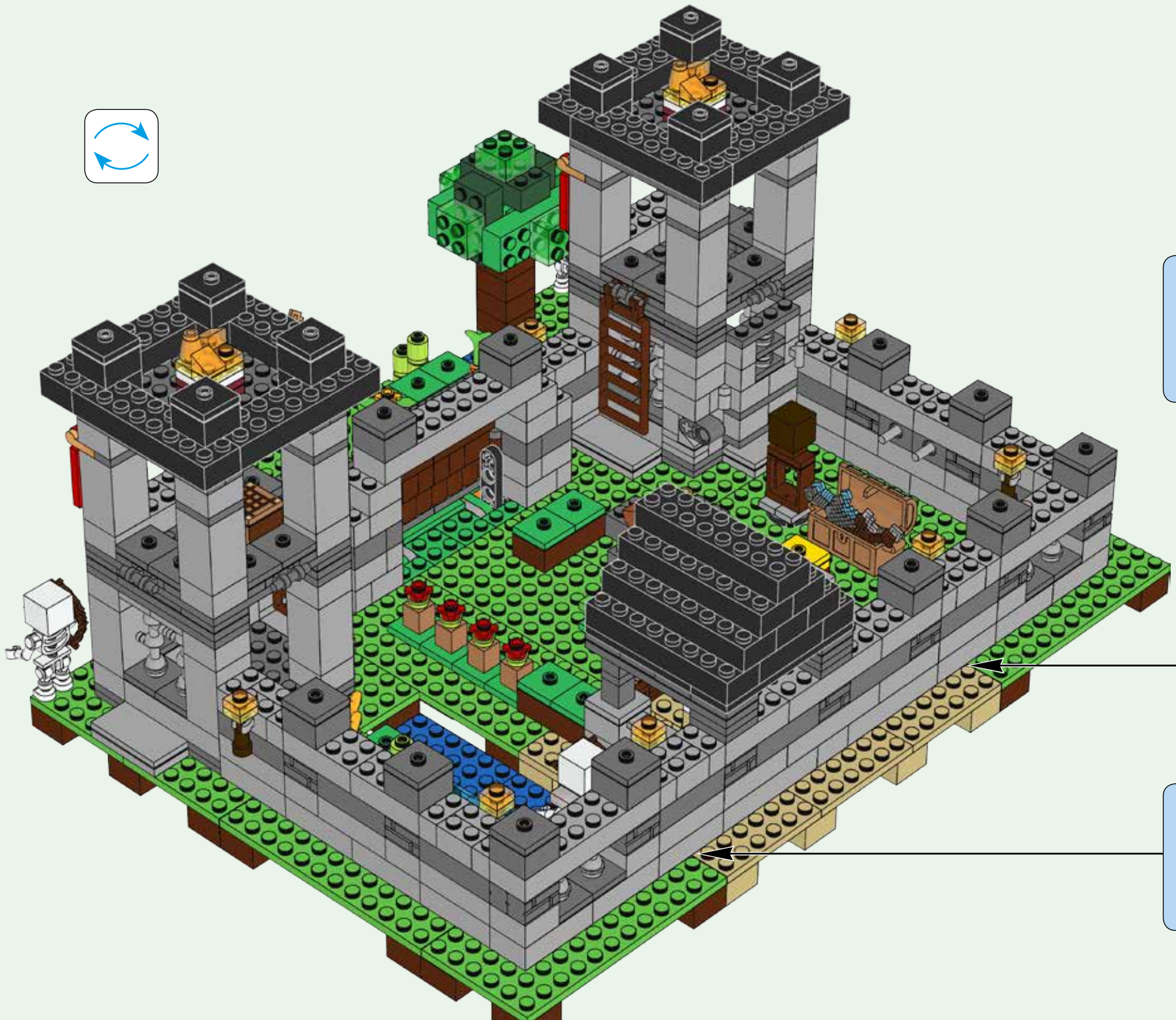
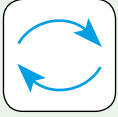



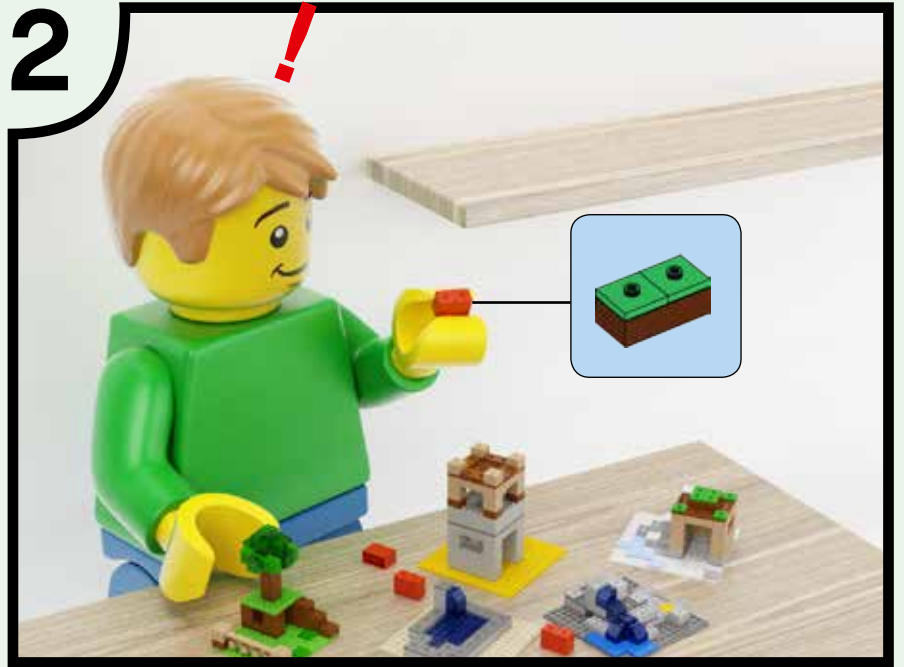
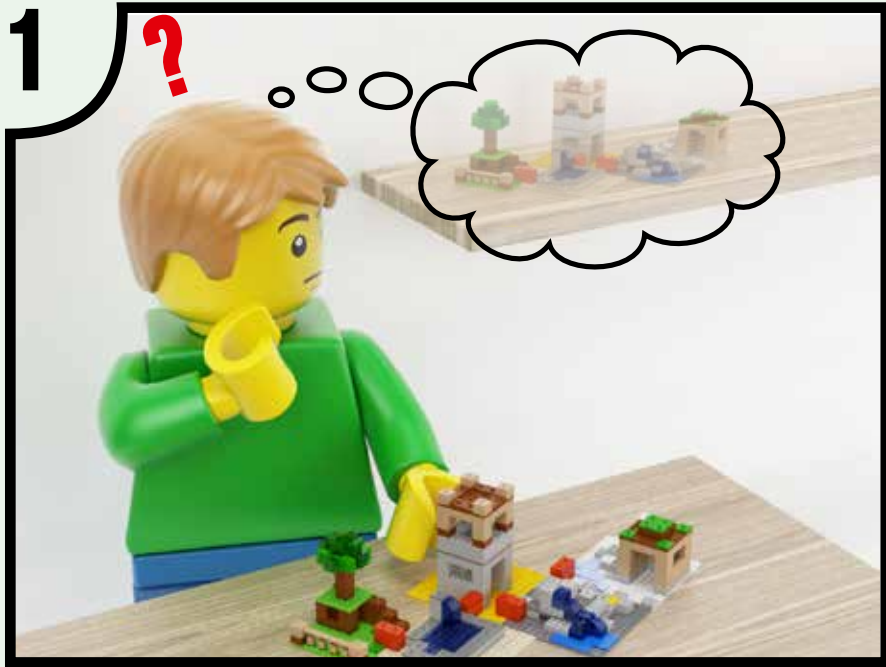



21127



21123



21128



21124

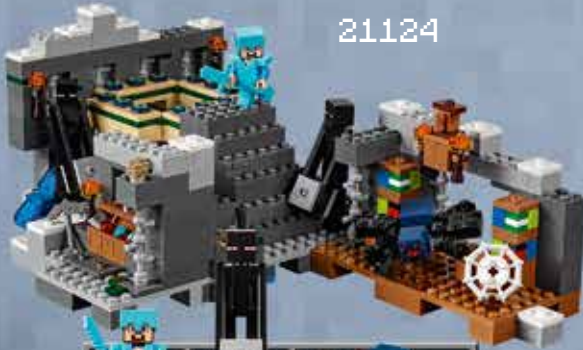

21125



21126



See more and share your creations on LEGO.com/minecraft

Découvrez d'autres modèles et partage tes créations sur LEGO.com/minecraft

Descubre otros modelos y comparte tus creaciones en LEGO.com/minecraft



LEGO and the LEGO logo are trademarks of the/son des marques de commerce du/son marcas registradas de LEGO Group. ©2016 The LEGO Group. © 2016 Mojang AB and/et/y Mojang Synergies AB. MINECRAFT is a trademark or registered trademark of/est une marque ou une marque déposée de/les una marca comercial o una marca comercial registrada de Mojang Synergies AB. 6163752