



# CREATOR™

# 3 IN 1

## 31145

3in1	3 w 1
3-in-1	3 v 1
3-en-1	3 az 1-ben
3 in 1	3 ãn 1
3en1	„3 B 1“
3em1	3 ühes
3 合 1	„Trys viename“



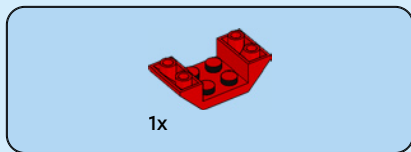

1

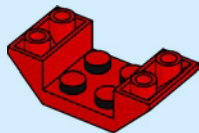



2x

2

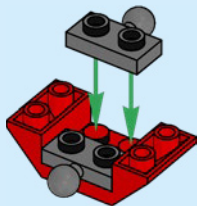

1x

3

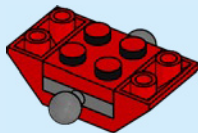



1x

4

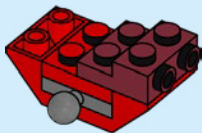

4

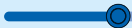

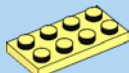

1x



1x

# 5

1



2

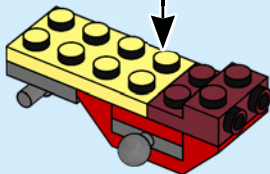
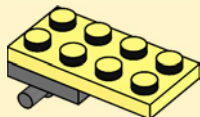

1x



1x



2x

# 6

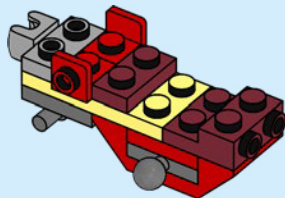



2x

7

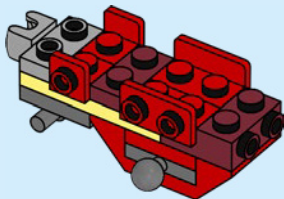

6

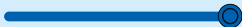



2x

8

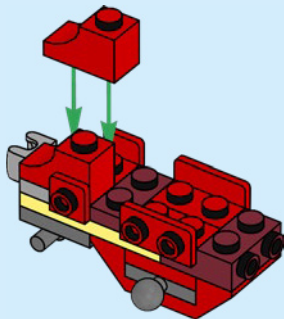

2x

9

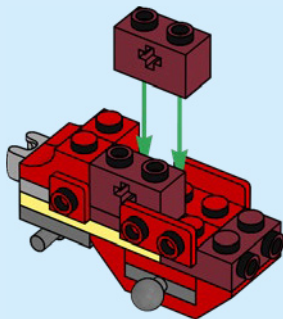



1x

10

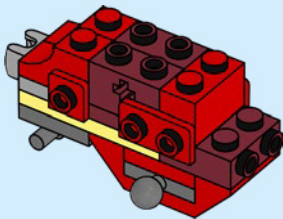





2x

11

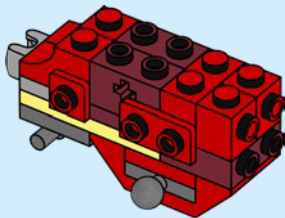

2x

12

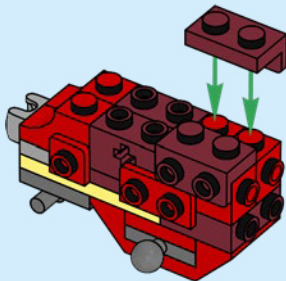



1x



2x



1x

# 13

1

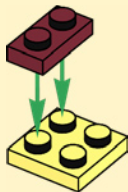

2

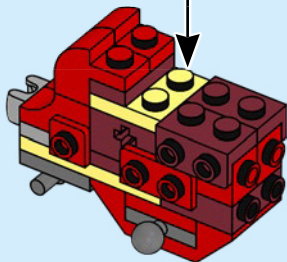
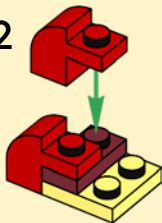



2x



1x

14

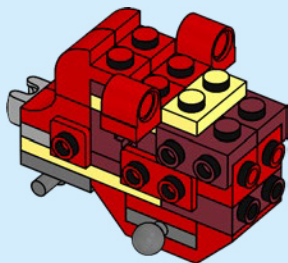

1x

15

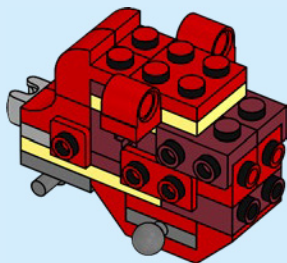



2x

16

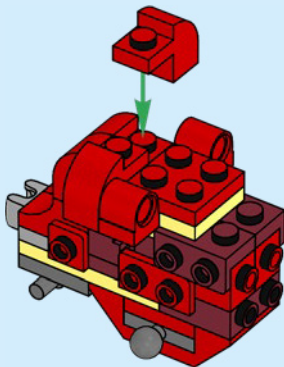



1x

17

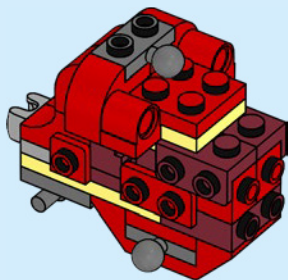

2x



2x

18

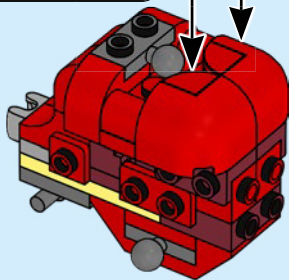
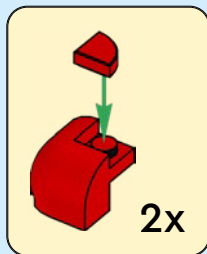



19

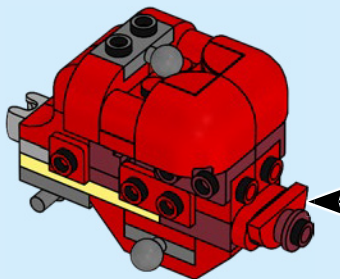
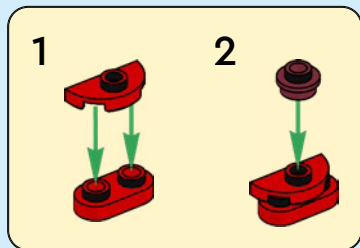



1x

20

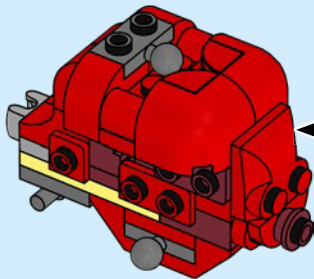



2x

21

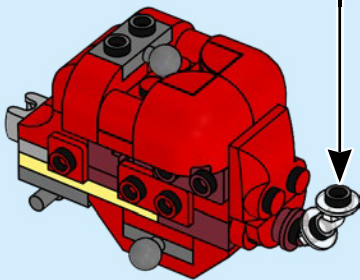
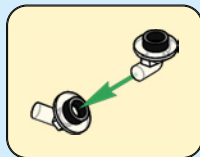



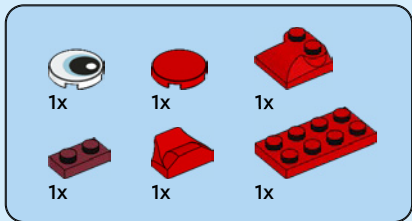

22

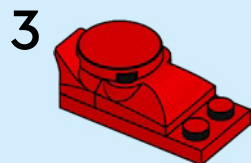
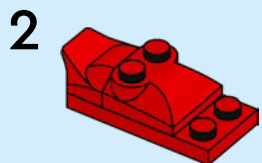
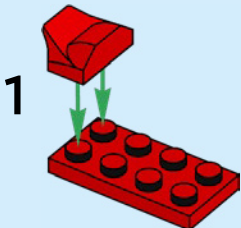

4

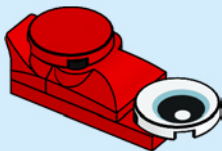

5

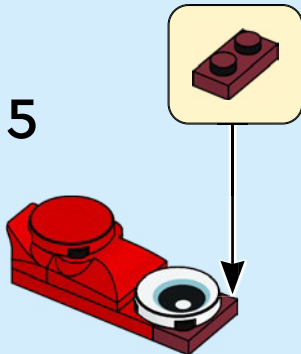

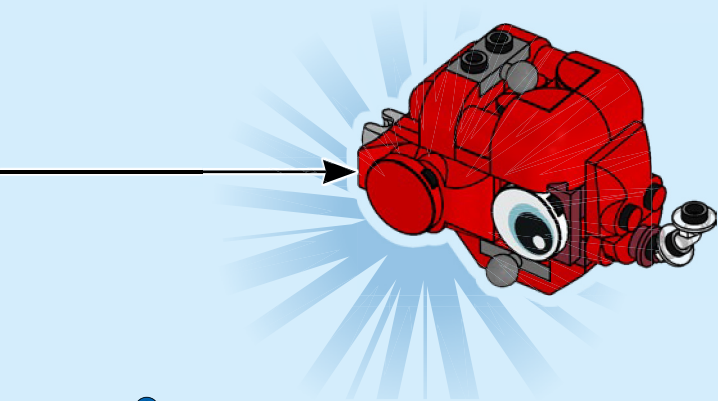



2x

23

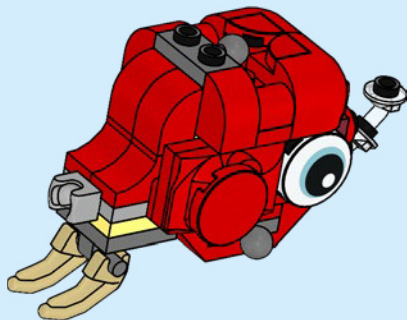

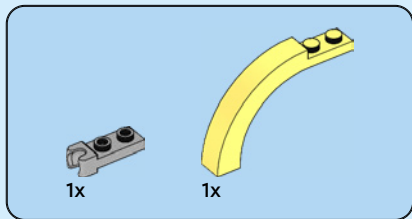

24

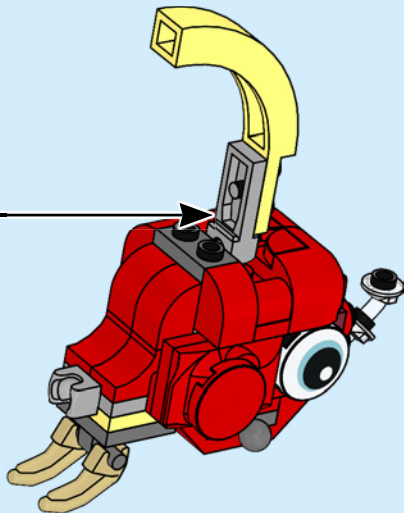
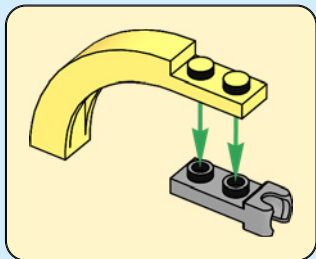

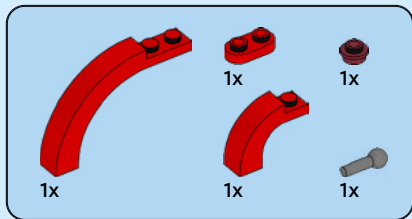

25

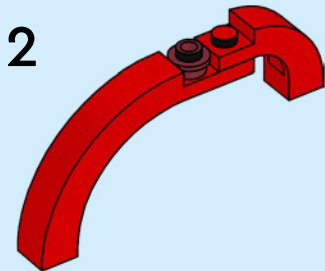
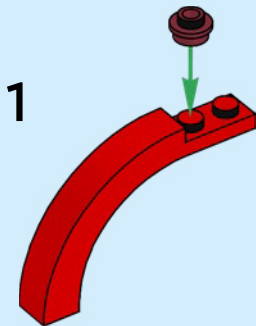

3

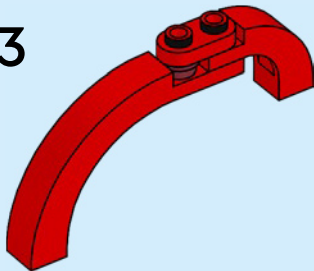

4

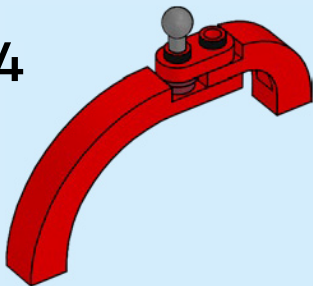

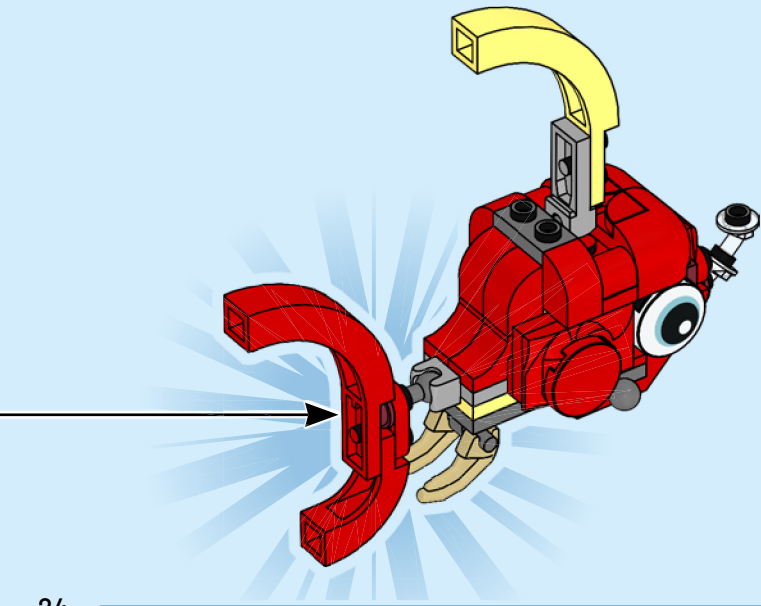





1x



1x



1x



1x



1x



1x

# 26

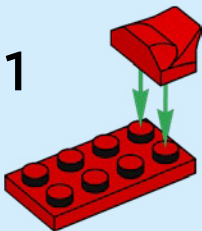

2

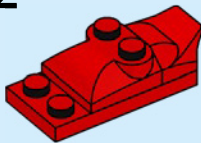

3

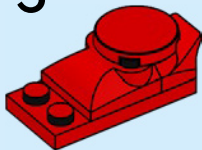

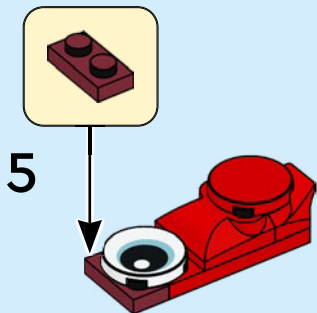
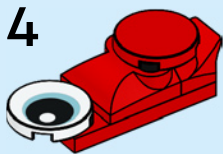

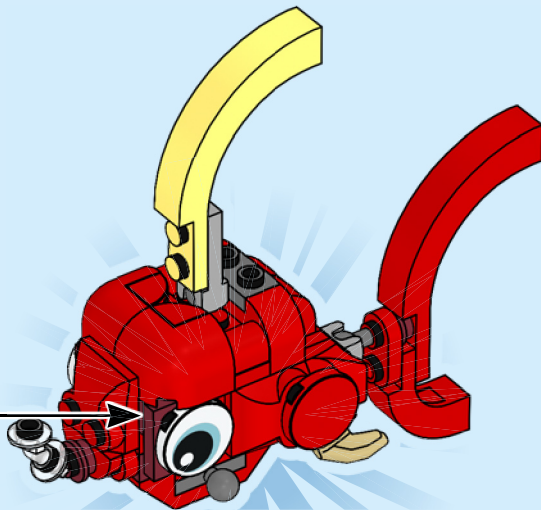

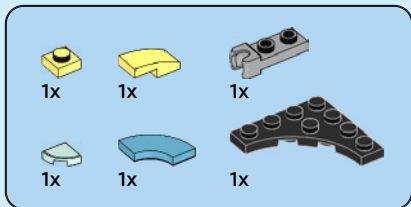

# 27

1

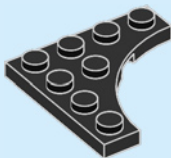

2

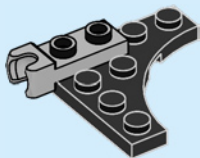

3

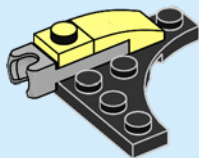

4

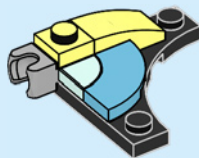

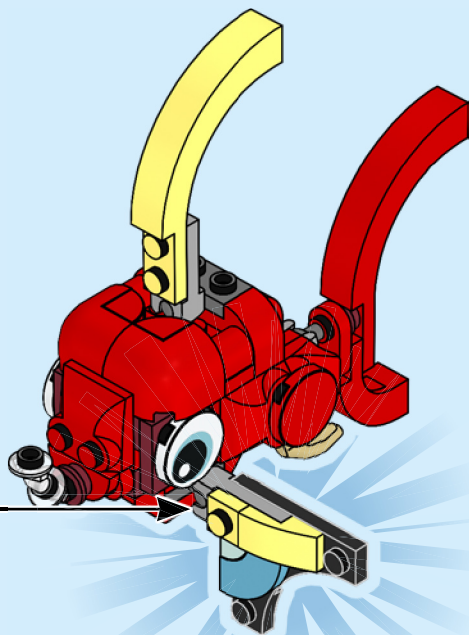

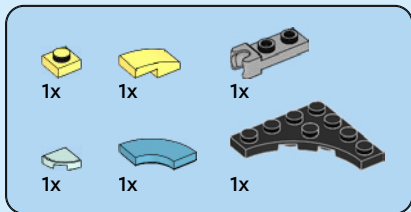

# 28

## 1



## 2

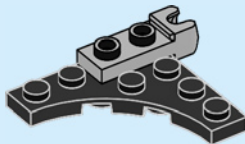

3

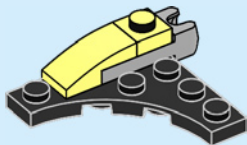

4

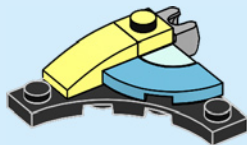

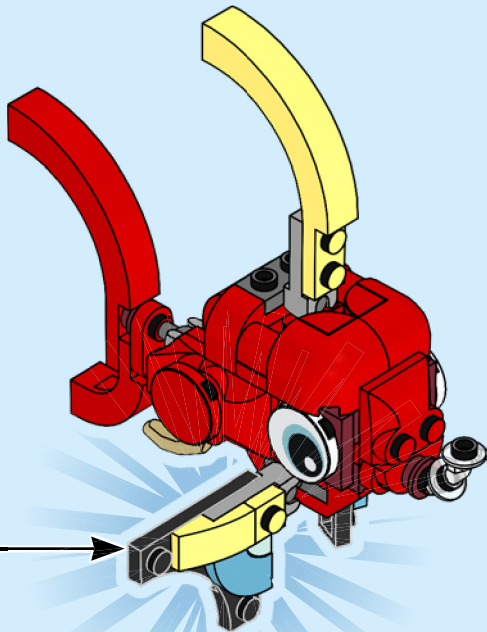
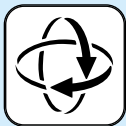



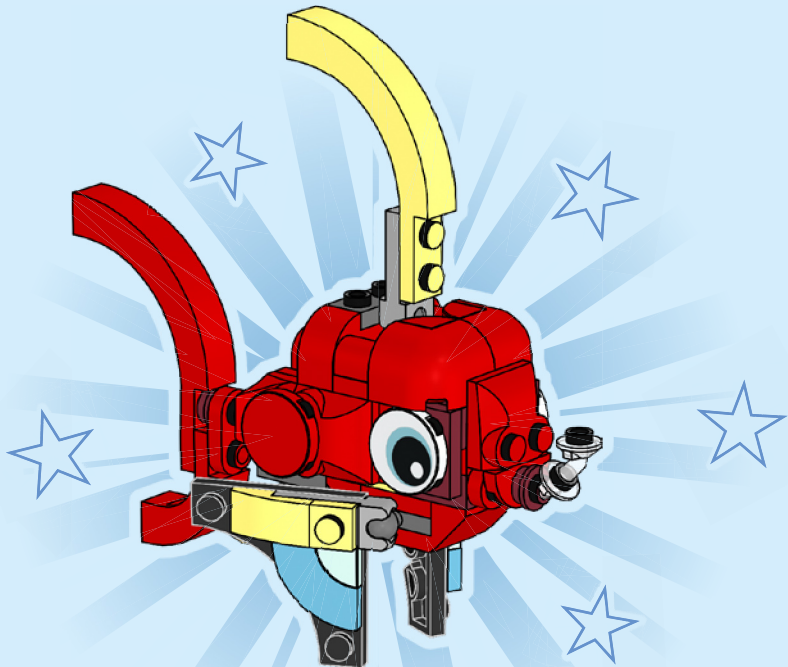



2x  
6252746



1x  
6368620



2x  
6440775



4x  
6143058



2x  
6046907



2x  
6378120



2x  
6170390



2x  
6249907



1x  
6400110



3x  
6210269



2x  
6066342



2x  
6176298



5x  
6375708



2x  
6369577



2x  
300421



4x  
6184782



2x  
6099736



1x  
6029946



1x  
6266205



2x  
6089698



3x  
4220515



5x  
302221



4x  
4558886



2x  
6384341



1x  
6212012



2x  
6294331



2x  
4178428



1x  
4653024



2x  
302021



1x  
487121



2x  
6384910



1x  
6297822



2x  
6361082



1x  
6337231



1x  
6371584



2x  
6147050



2x  
6208787



2x  
6285587



3x  
6168645



1x  
6431687



4x  
4539097



2x  
6206250



2x  
6264026



1x  
6359692



1x  
6470185



6x  
6443149



2x  
6225246



5x  
6043656



7x  
6043639



1x  
6364352



5x  
6039479



1x  
6457961



1x  
6423955



2x  
6058014



4x  
6201647



3x  
6147726



2x  
6316265



2x  
6469045



1x  
6296524



1x  
6289285



6x  
6150307



2x  
6071246



2x  
6258069



2x  
6199886



[LEGO.com/service](https://www.LEGO.com/service)

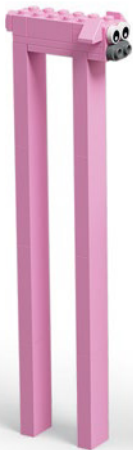

Rebuild  
the  
world™

