



CREATOR™



31148



LEGO® Builder



Get excited about our new packaging!

We're switching from plastic to paper-based packaging. That's why you might find a mix of paper and plastic in our boxes!

Nos nouveaux emballages vous emballeront !

Nous passons des emballages en plastique aux emballages à base de papier. C'est pourquoi vous pourriez trouver un mélange de papier et de plastique dans nos boîtes !

¡Te presentamos nuestros nuevos empaques!

Estamos sustituyendo las bolsas de plástico por bolsas con base de papel. ¡Por eso, puedes encontrar una mezcla de papel y de plástico en nuestras cajas!

[LEGO.com/sustainable-packaging](https://www.lego.com/sustainable-packaging)

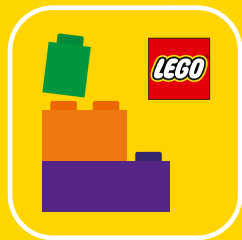

Q LEGO® Builder

BUILDER



Apple and the Apple logo are trademarks of Apple Inc., registered in the U.S. and other countries and regions. App Store is a service mark of Apple Inc. Google Play and the Google Play logo are trademarks of Google LLC. Tencent and the Tencent logo are trademarks of Tencent Inc.

Q LEGO.com/devicecheck

EN Ask parents' permission before going online | **DE** Eltern um Erlaubnis bitten, bevor du online gehst | **FR** Demande l'autorisation d'un parent avant d'aller en ligne | **IT** Chiedi il permesso ai tuoi genitori prima di andare online | **ES** Pídeles permiso a tus papás antes de conectarte a Internet | **PT** Pede autorização aos pais antes de acederes online | **ZH** 上网前应先征得父母的同意 | **PL** Poproś rodziców o zgodę, zanim wejdiesz do Internetu | **CS** Než půjdeš na internet, požádej rodiče o svolení | **SK** Skôr než pôjdeš na internet, vypýtaj si povolenie od rodičov | **HU** Kérj szülői engedélyt, mielőtt online csatlakoznál! | **RO** Cere permisiunea părinților înainte de a te conecta online | **BG** Поискайте разрешение от родител, преди да влезете онлайн | **LV** Pirms došanās tiešsaistē palūdz atļauju vecākiem | **ET** Enne Interneti kasutamist küsi vanematelt luba | **LT** Prieš prisijungdami prie interneto, atsiklauskite tėvų

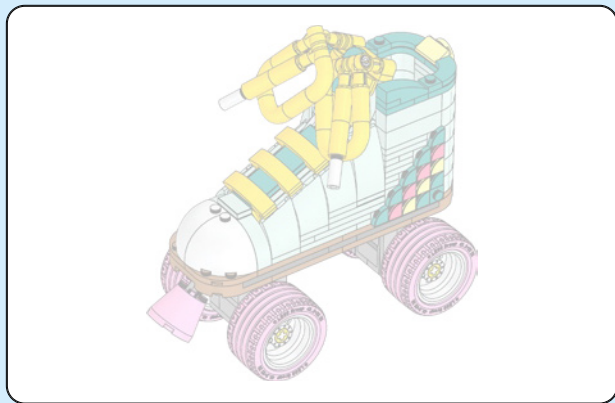

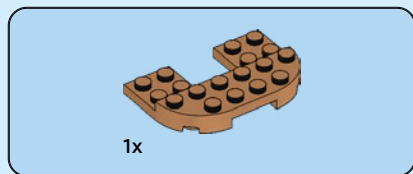

1

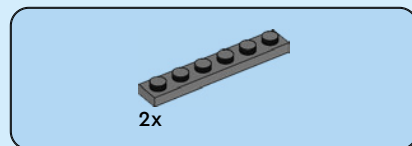
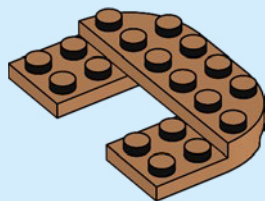

2

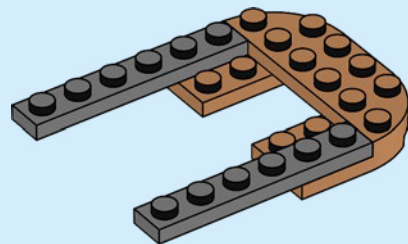



2x

3

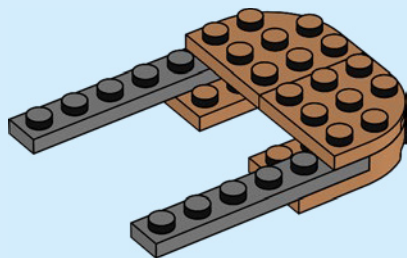

2x

4

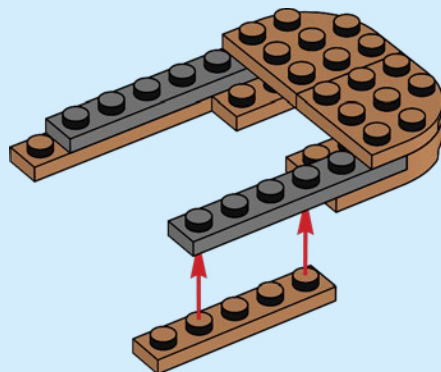



5

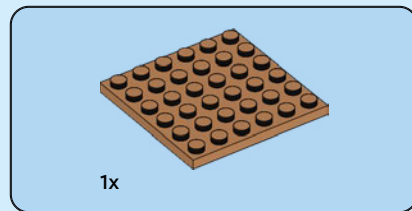
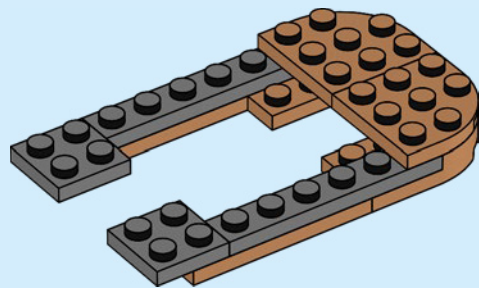

6

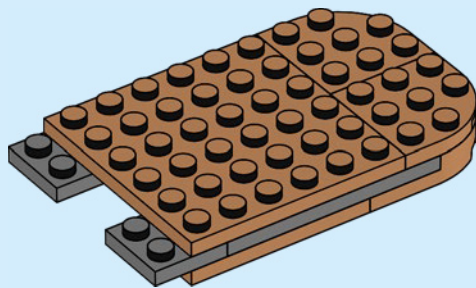

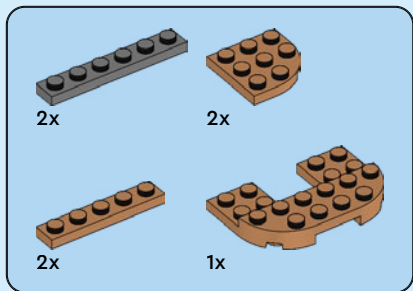

7

1

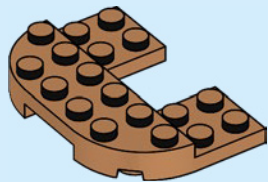

2

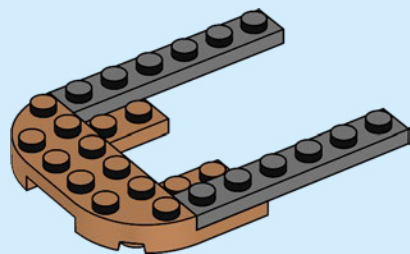

3

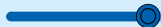
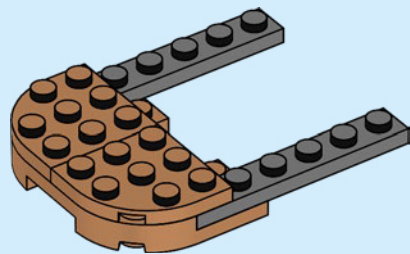

4

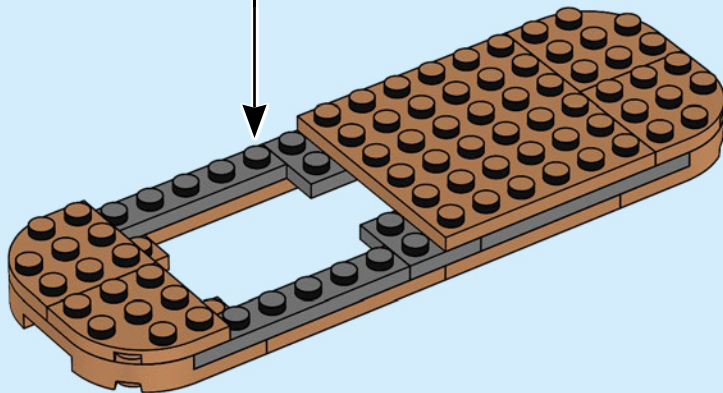
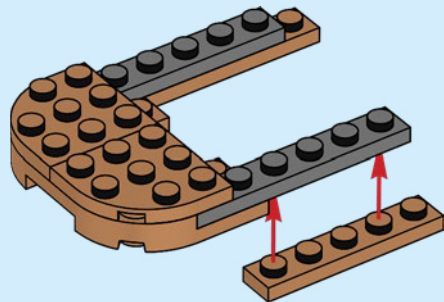

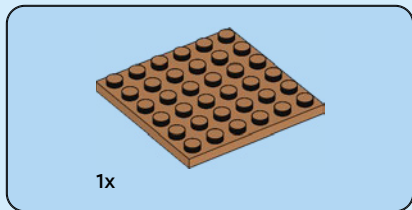

8

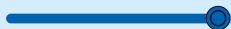
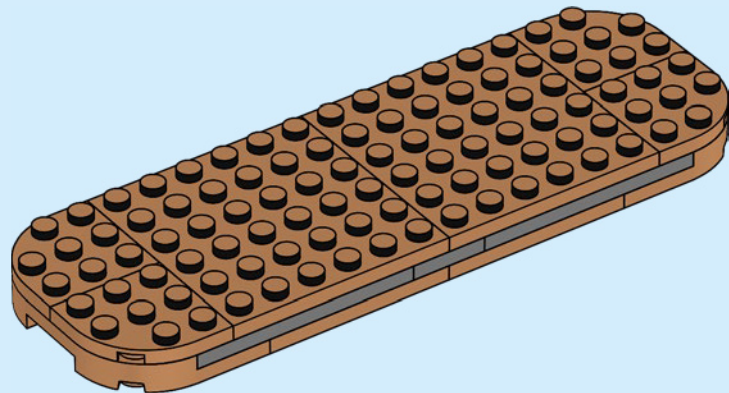

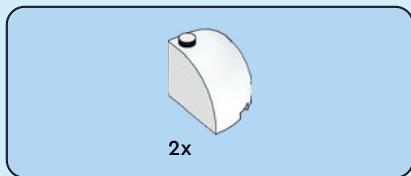

9

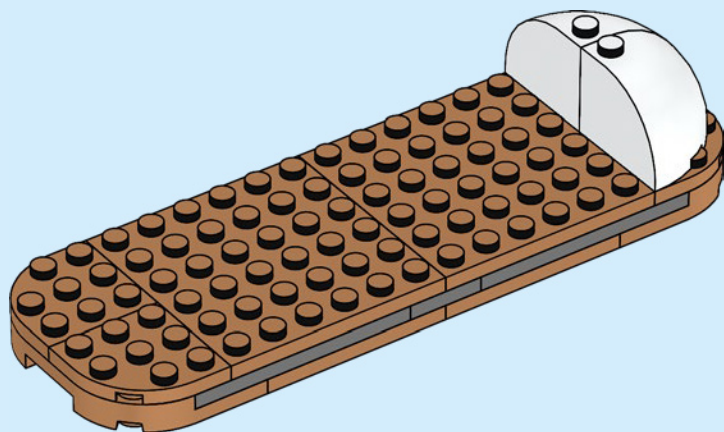

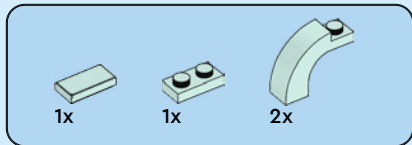

10

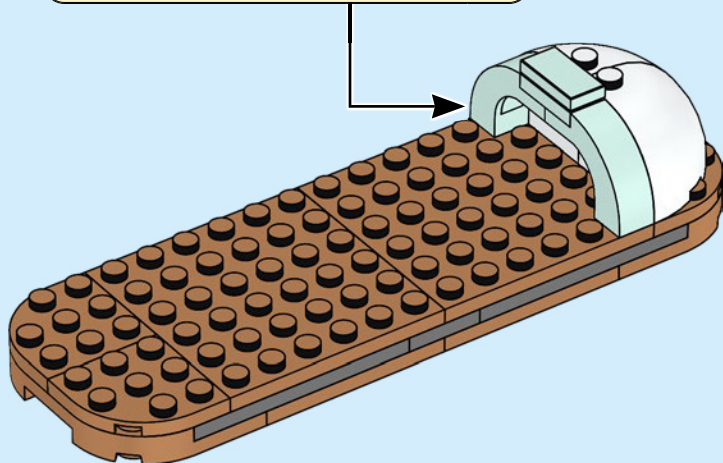
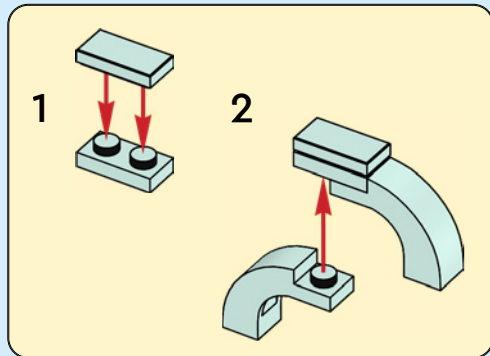

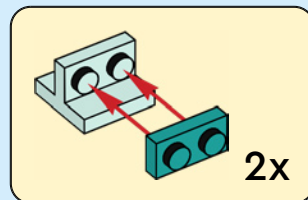
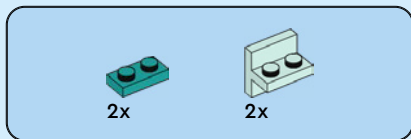

11

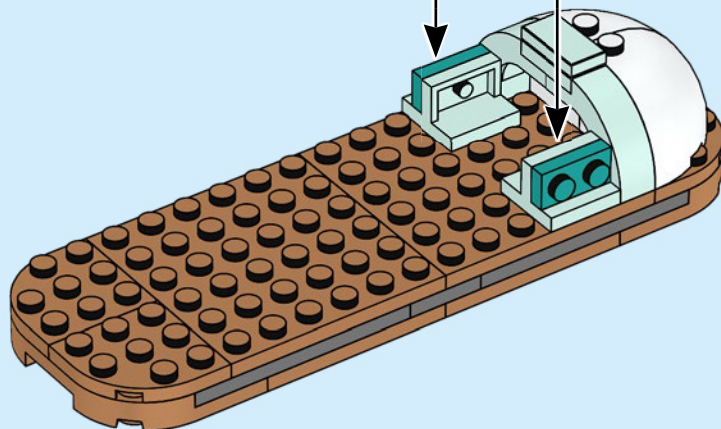

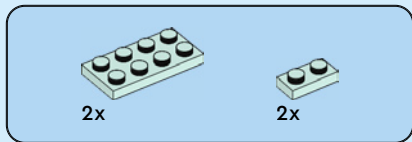

12

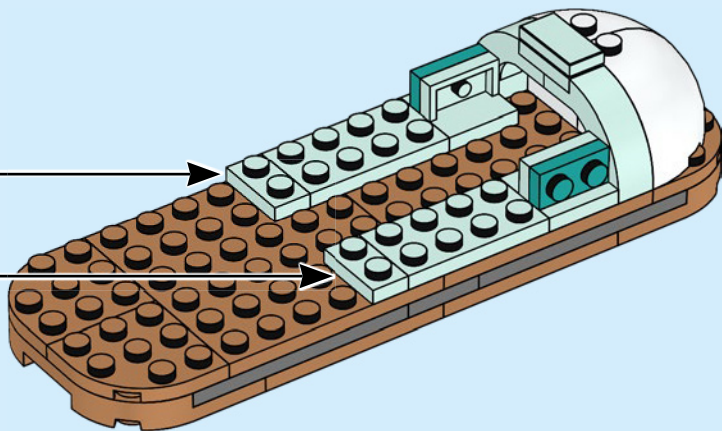
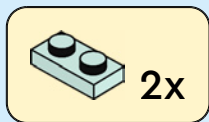



2x



2x

13

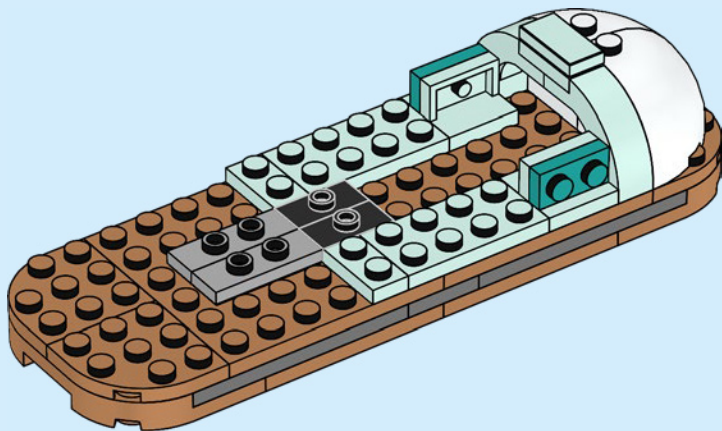



2x



2x



2x

14

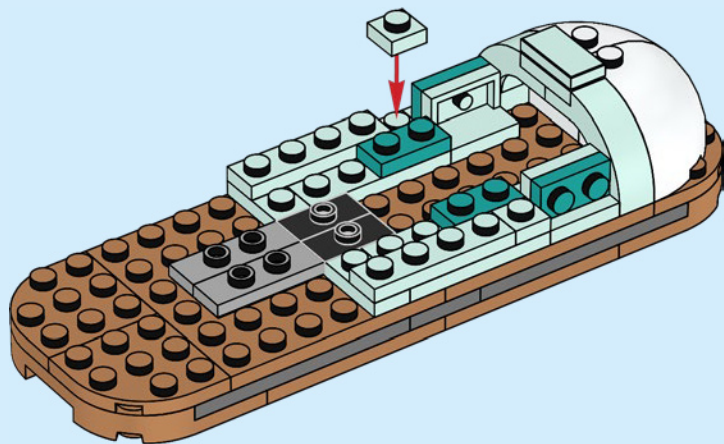

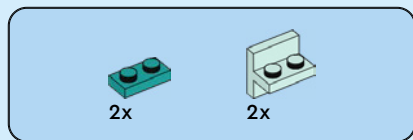

15

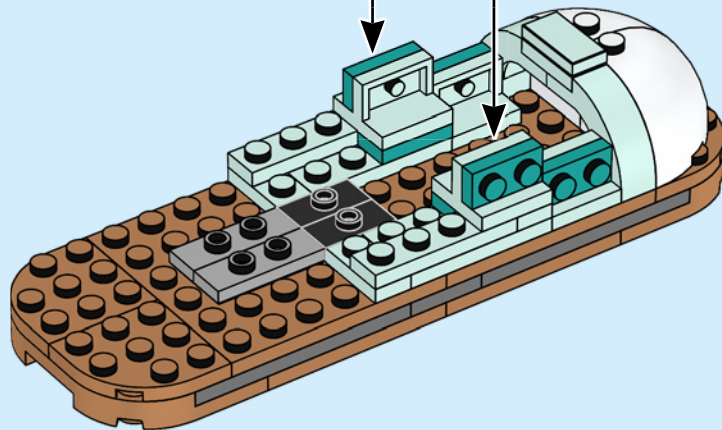
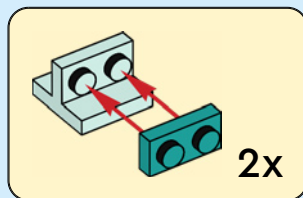



2x

16

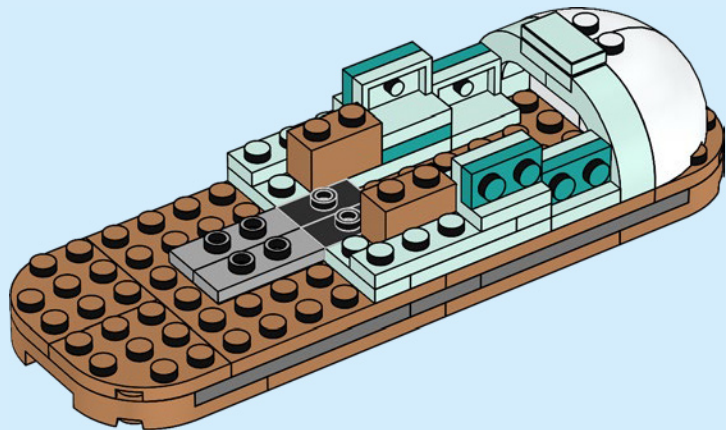



2x



2x

17

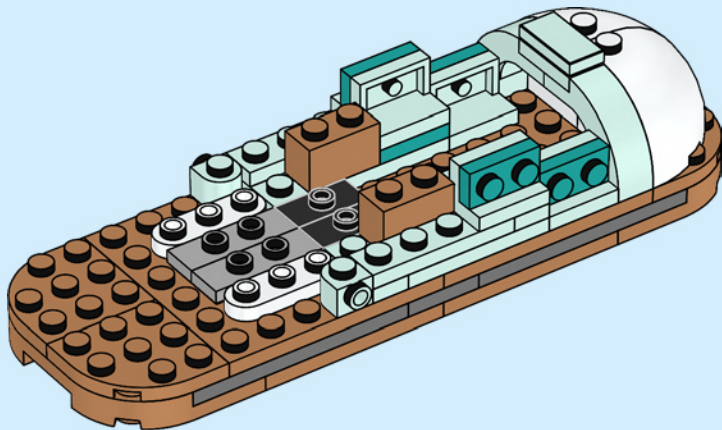



2x

18

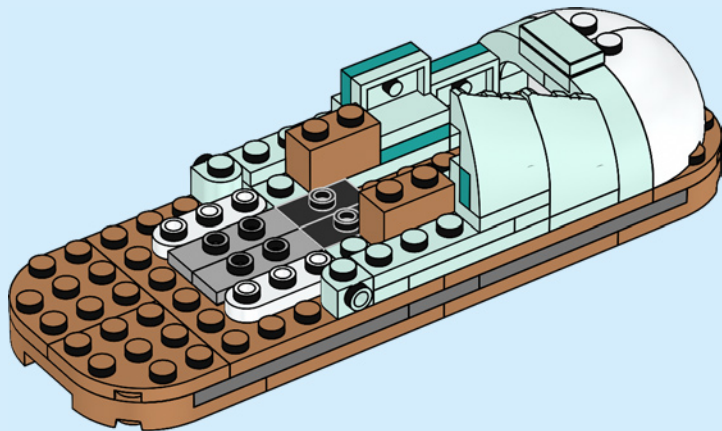



2x

19

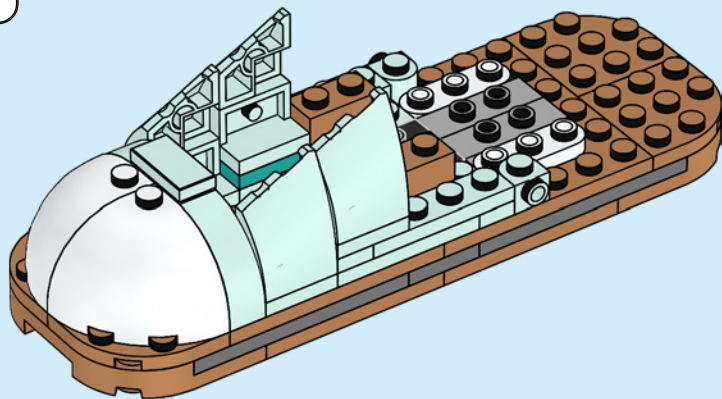

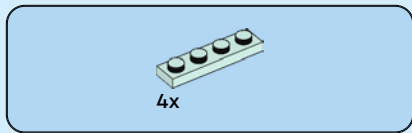

20

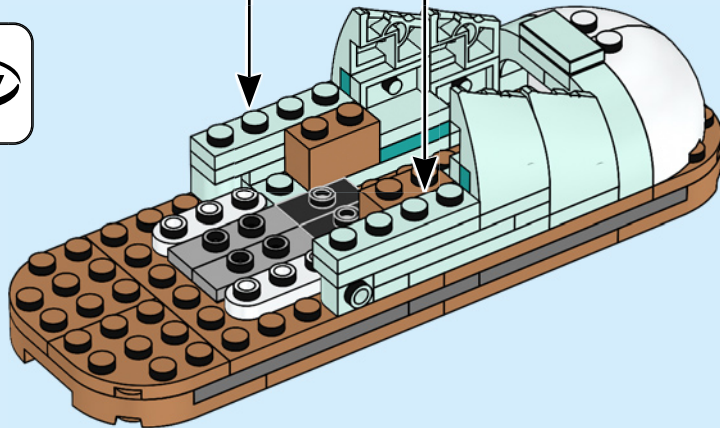
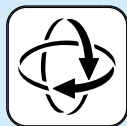
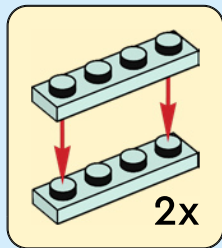

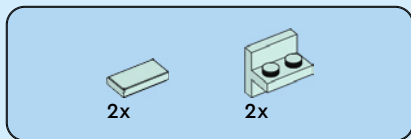

21

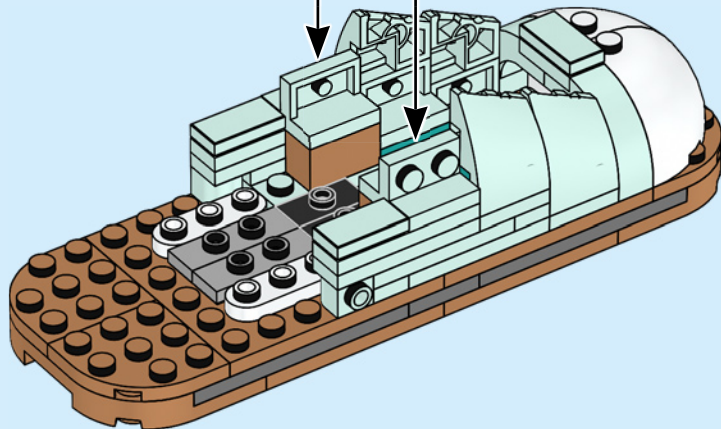
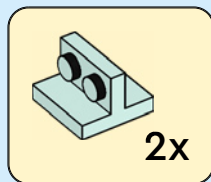

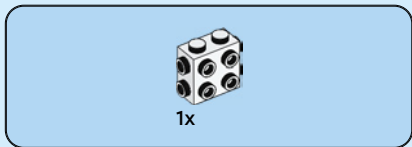

1x

22

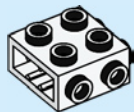

1x

23

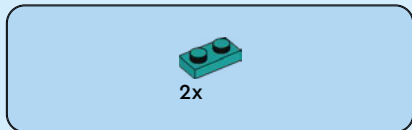
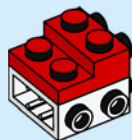

2x

24

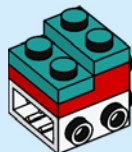



1x

25

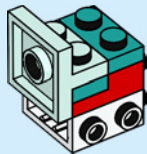

1x



1x

26

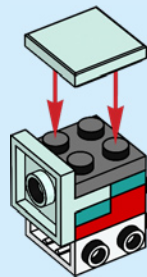



2x

27

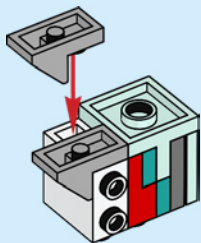

26



1x

28

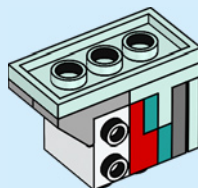



2x

29

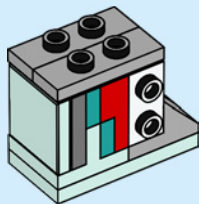
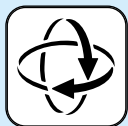

1x



1x

30

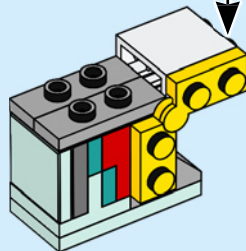
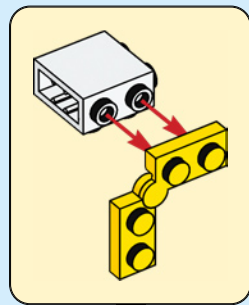



1x

31

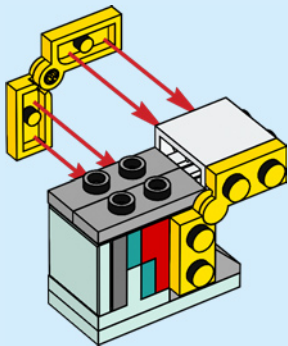

1x

32

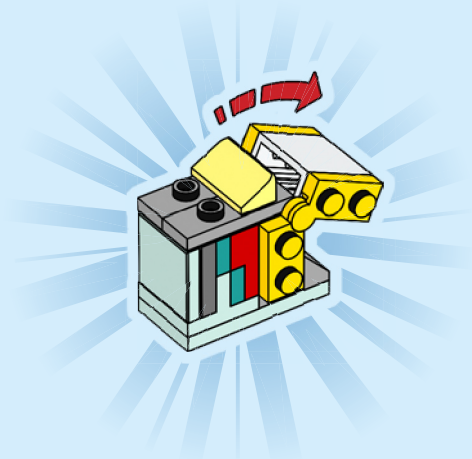

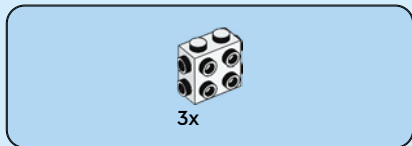
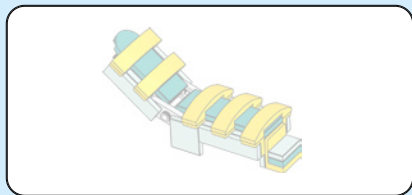

33

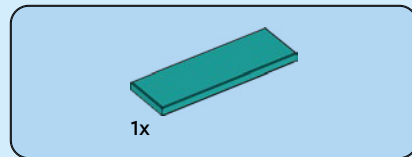
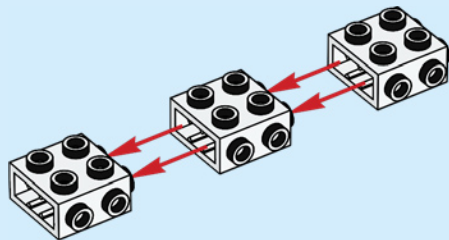

34

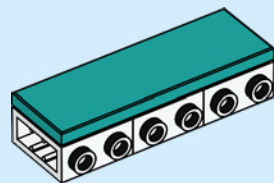



2x



3x

35

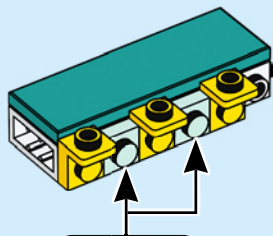

2x



2x



1x



3x

36

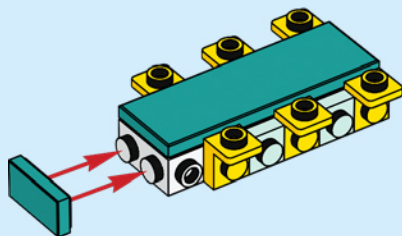



1x

37

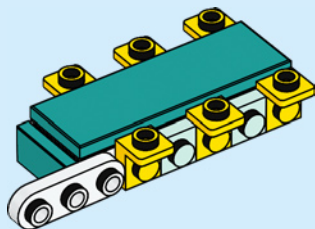

2x

38

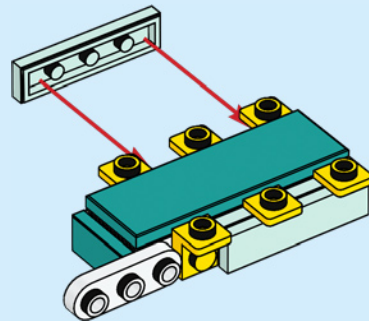

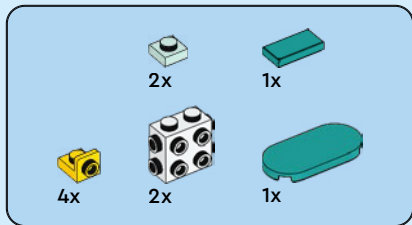

39

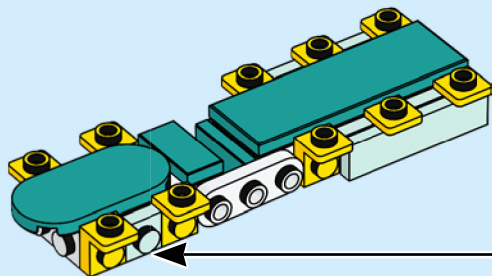
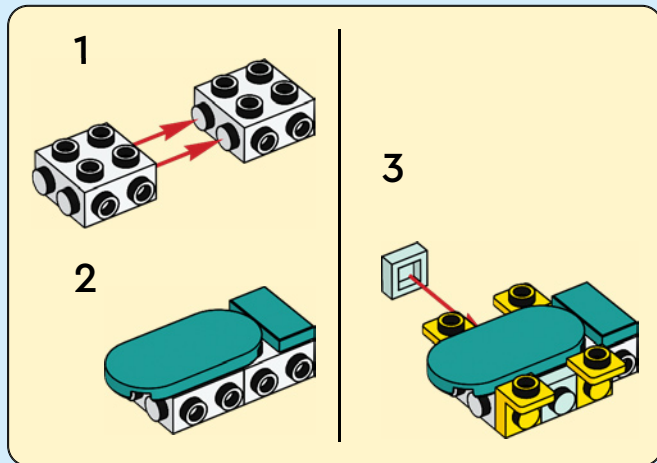



1x

40

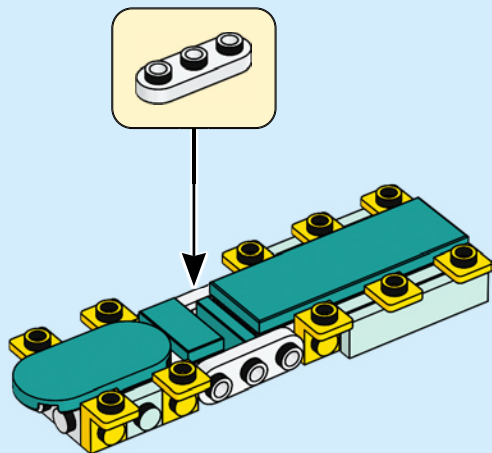

2x

41

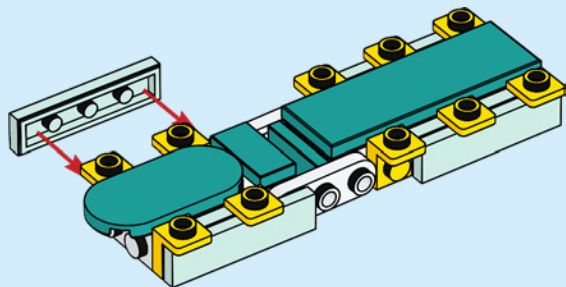



5x

42

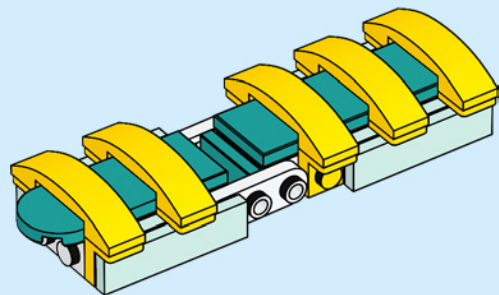

2x



1x



1x

43



1



2

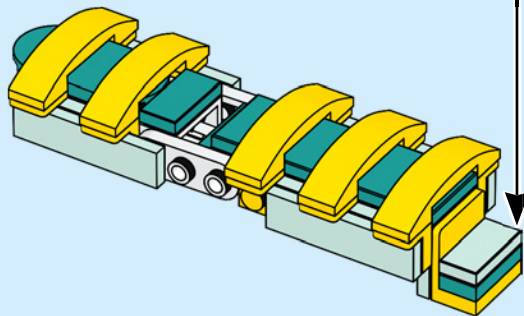
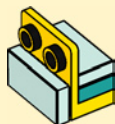



1x

44

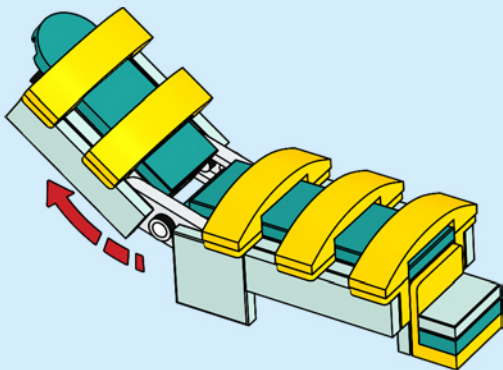

45

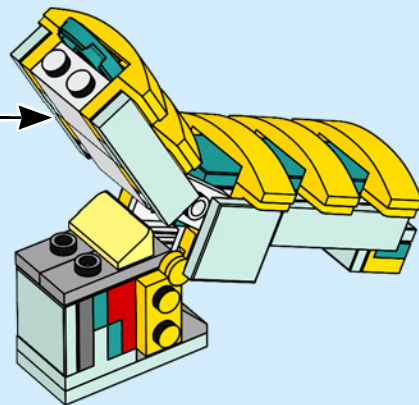



1x

46

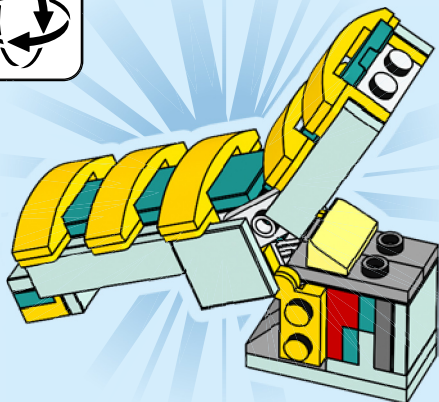

47

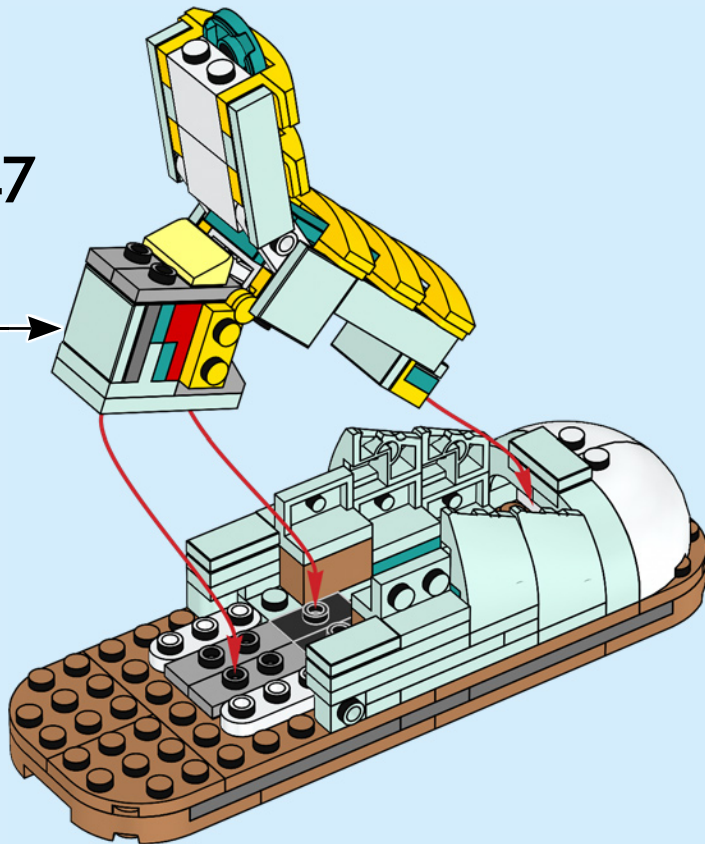

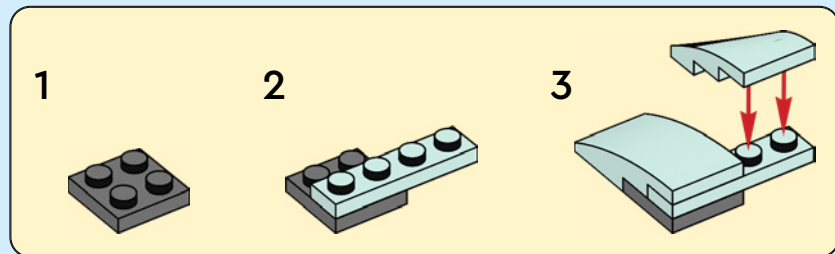
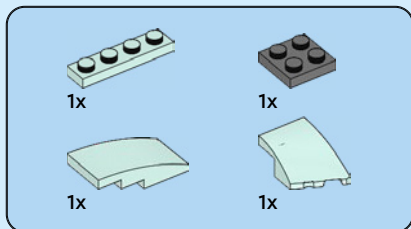

48

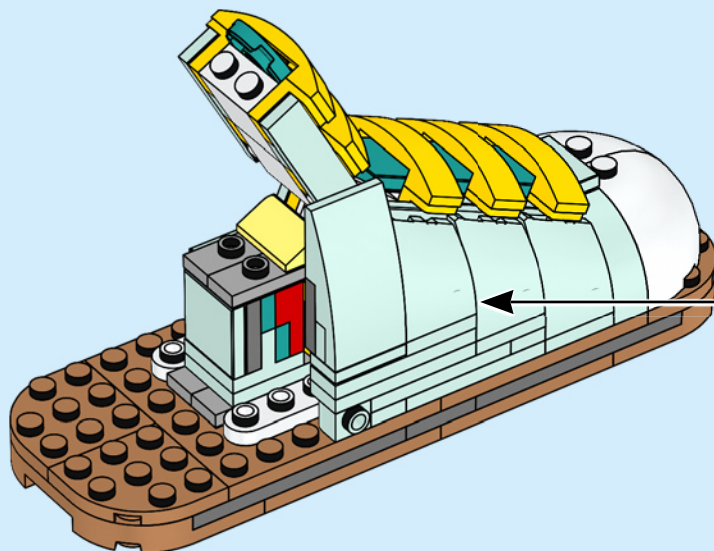

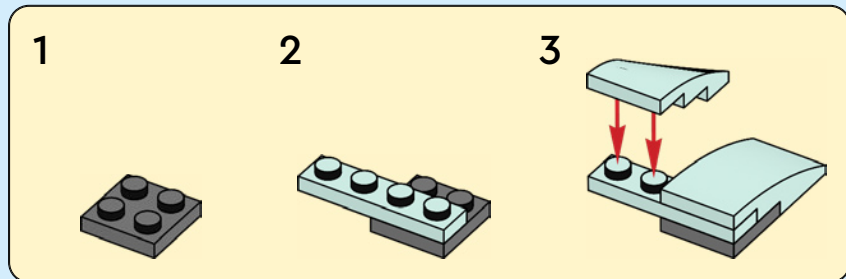
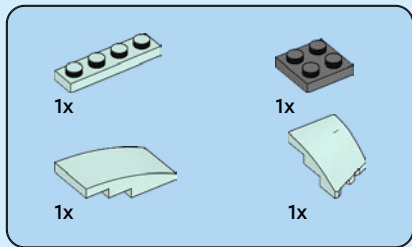

49

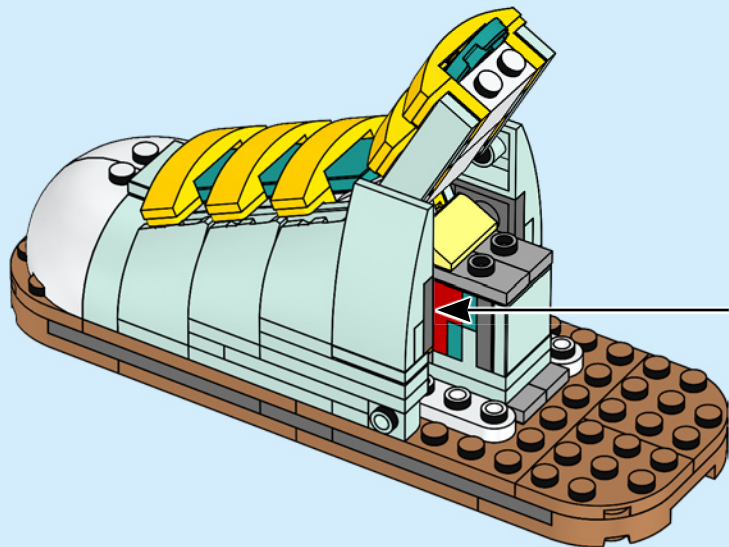
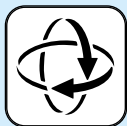

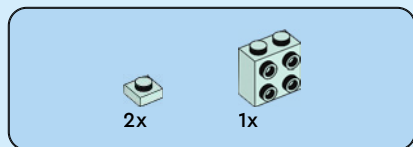

50

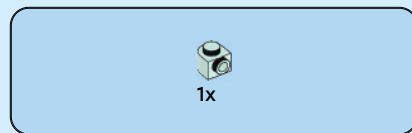
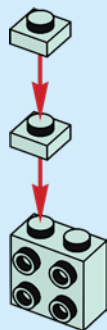

51

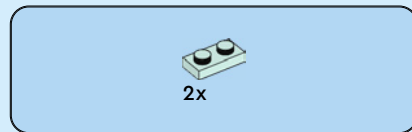

52

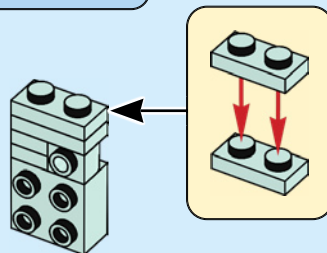

53

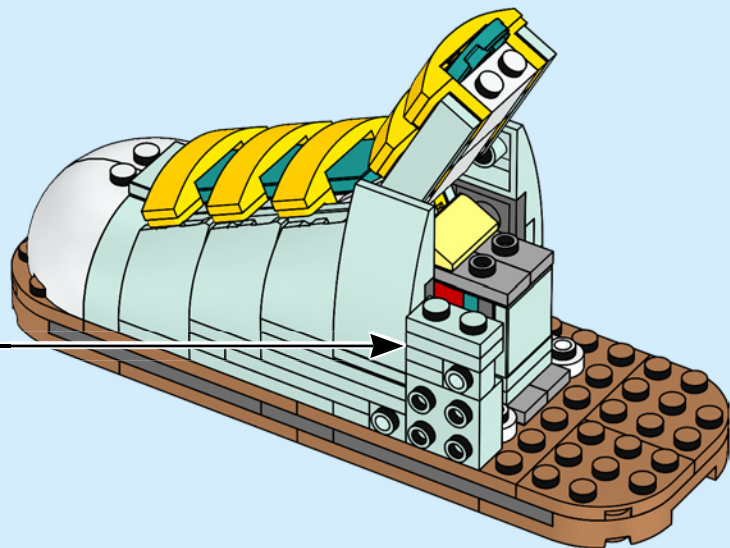

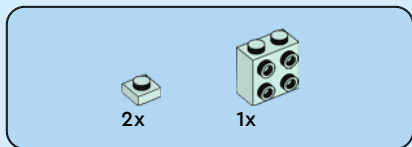

54

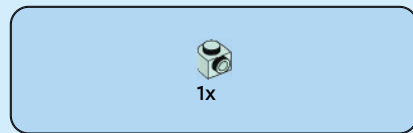
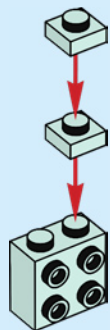

55

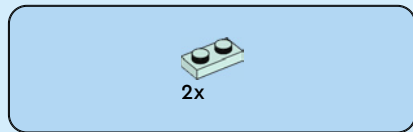
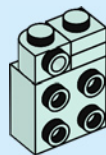

56

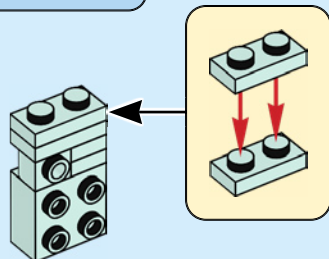

57

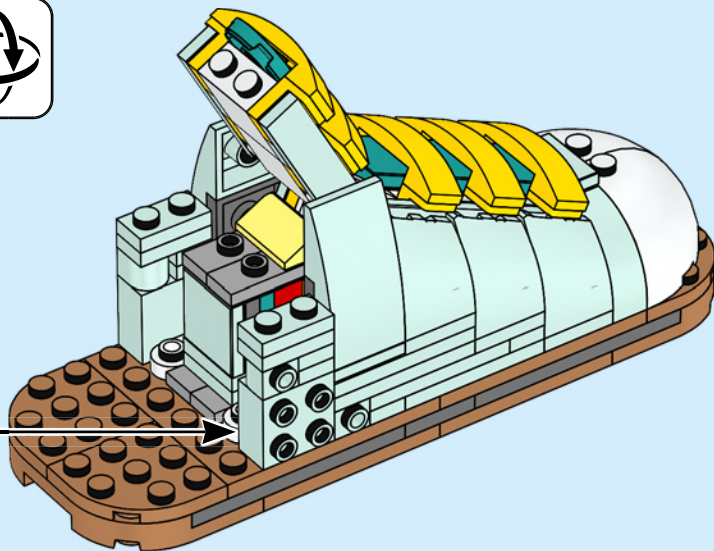



2x

58

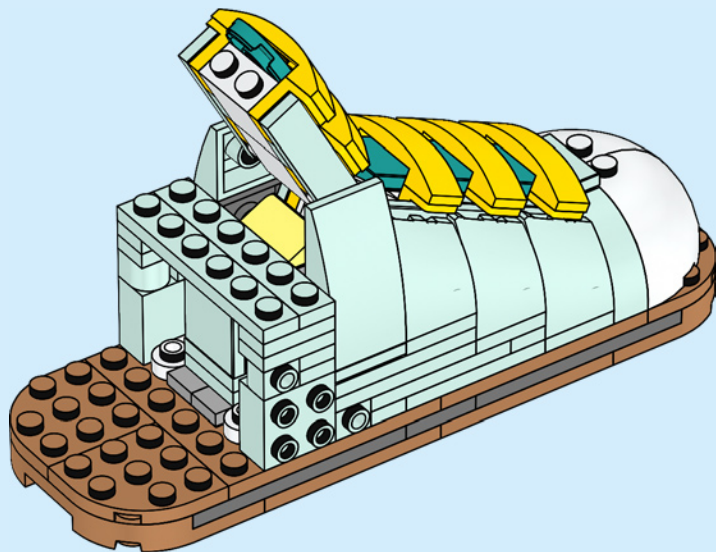

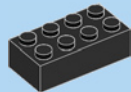

1x



2x

59

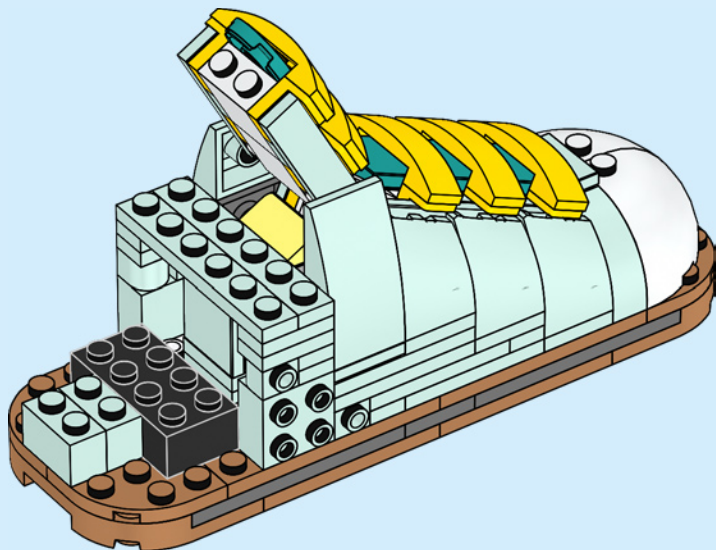



4x

60

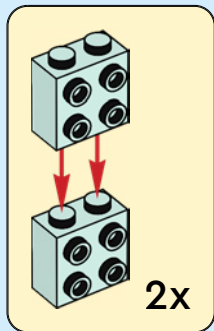

2x

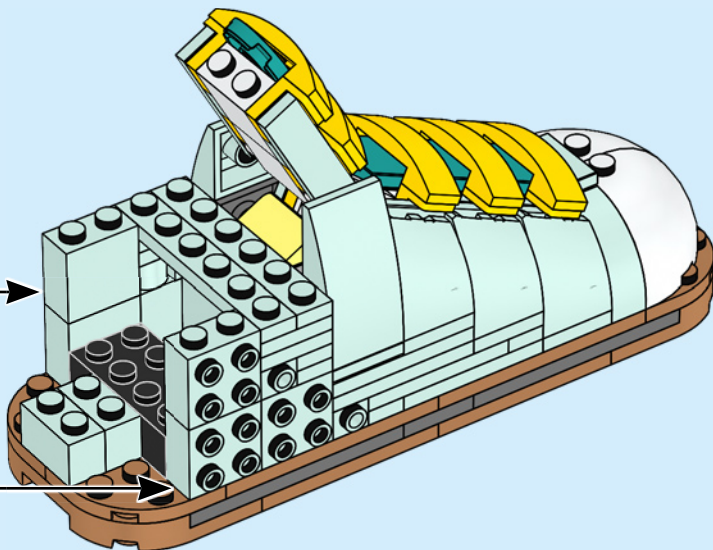

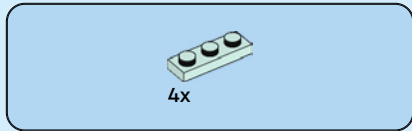

61

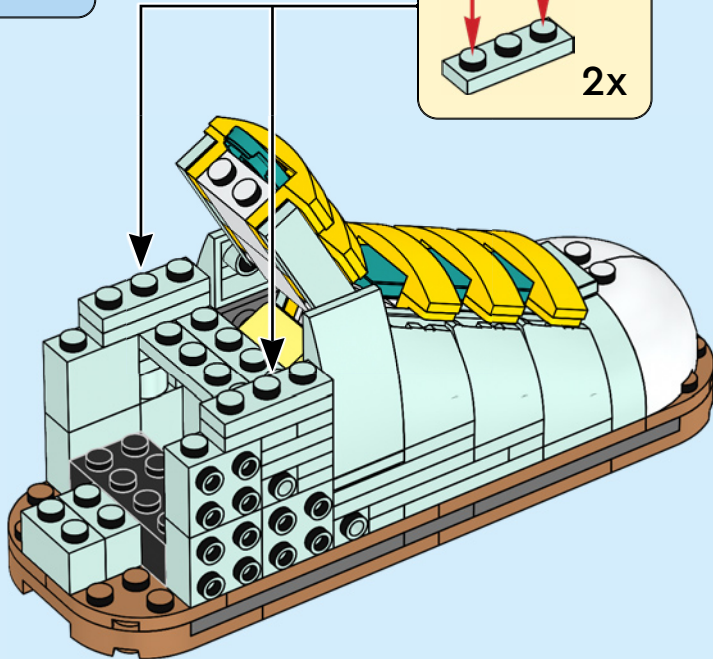
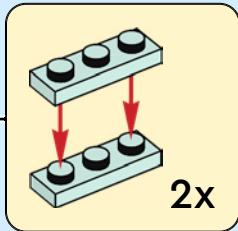



2x

62

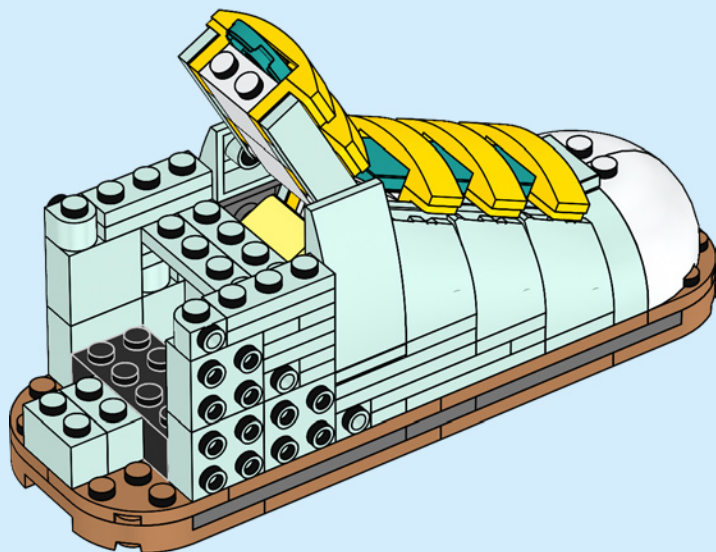



4x

63

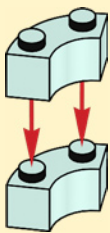

2x

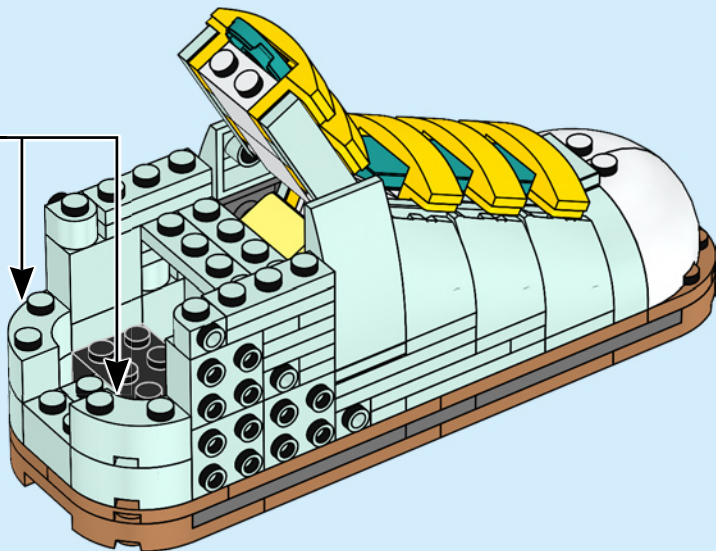



2x

64

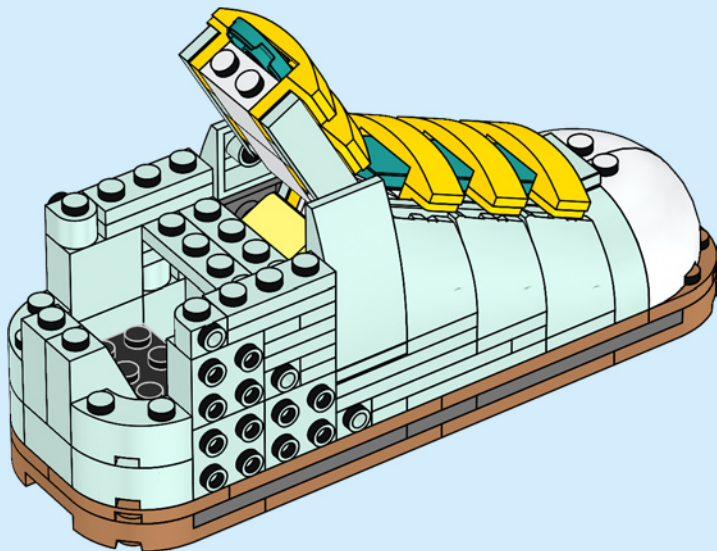

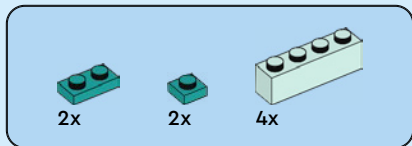

65

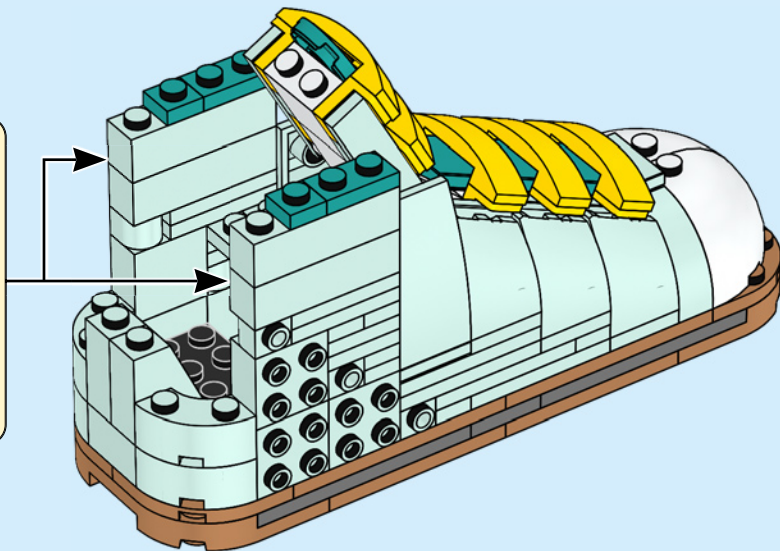
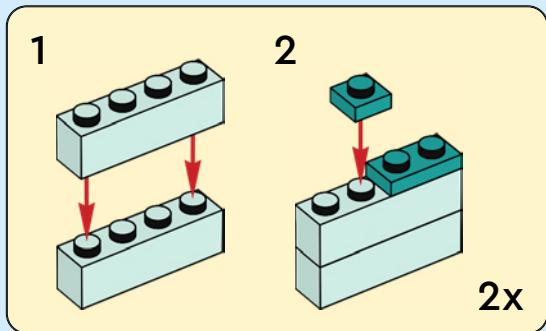

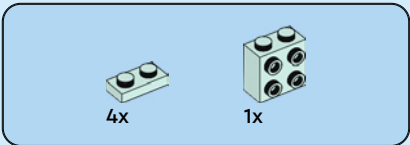

66

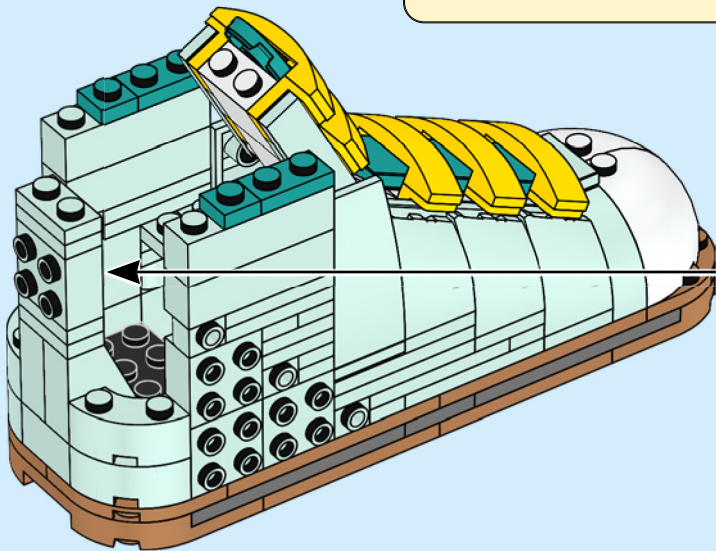
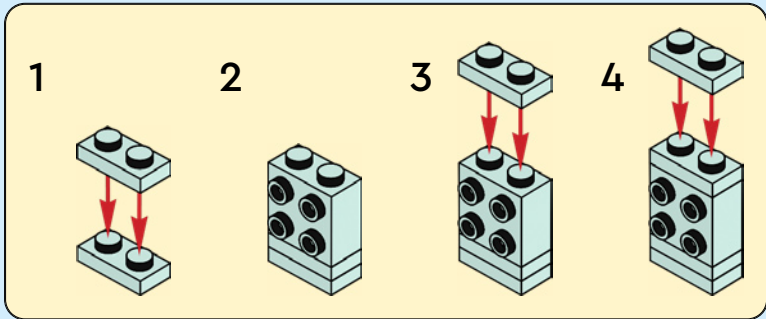



8x

67

1

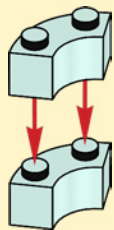

2

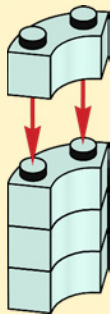

2x

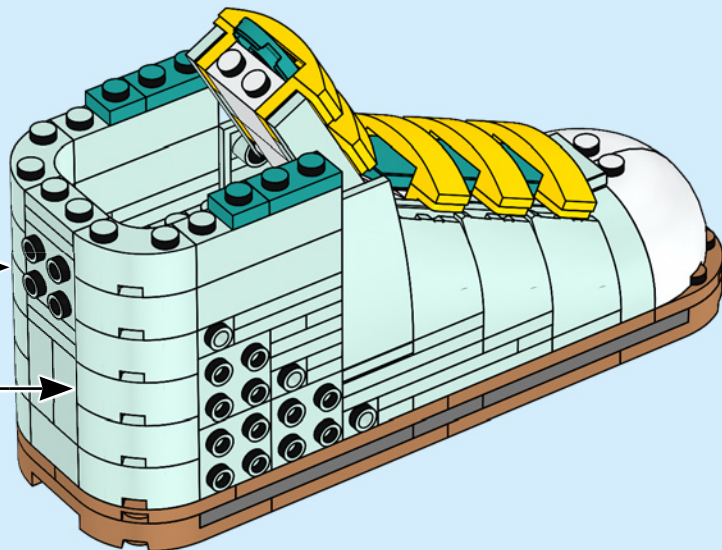



2x

68

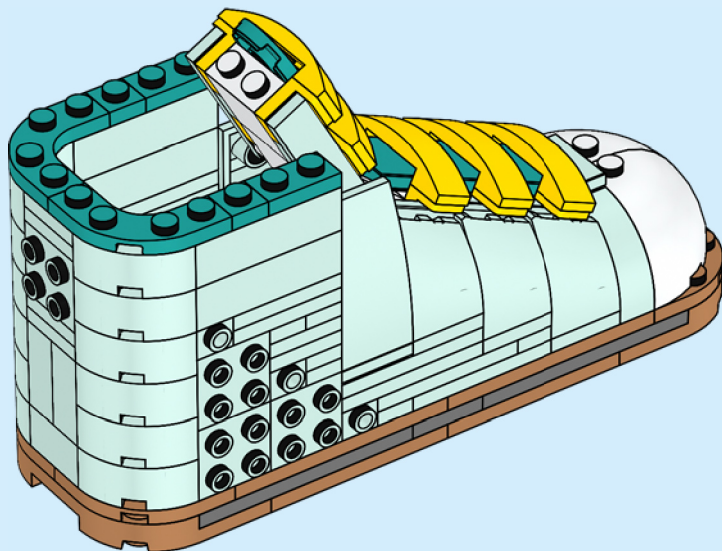





1x



3x



2x

69

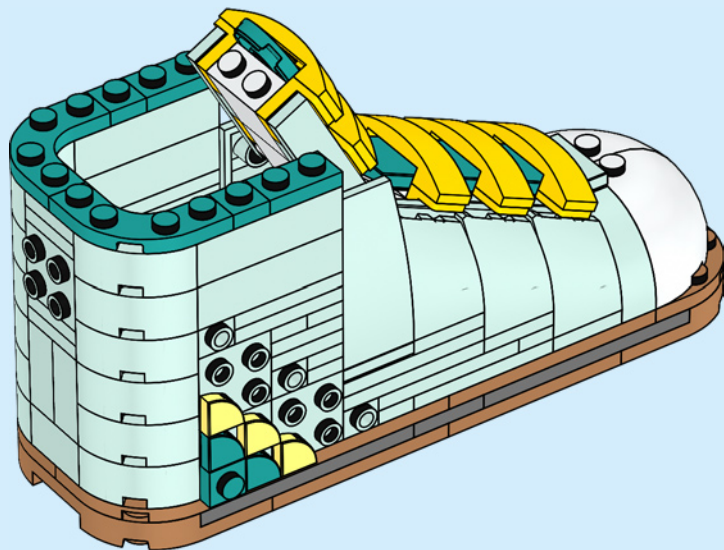



5x



4x

70

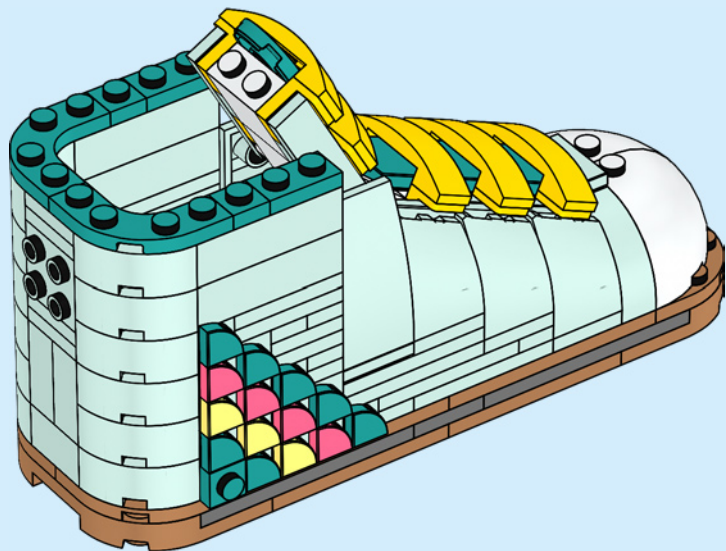



1x



3x



2x

71

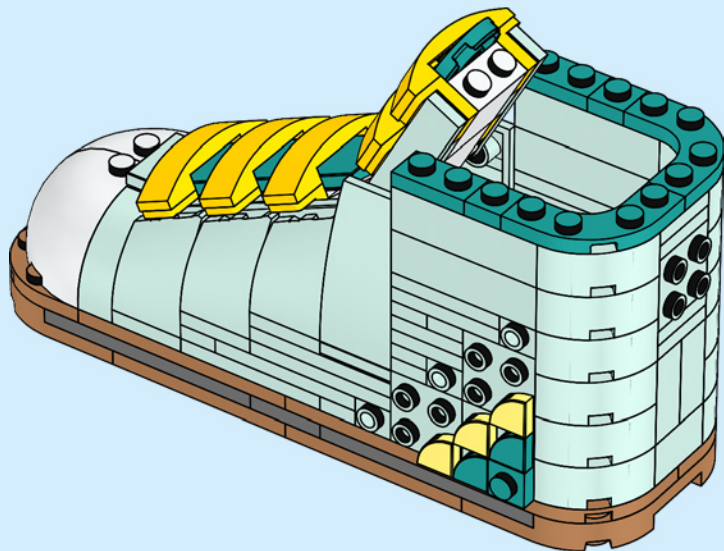



5x



4x

72

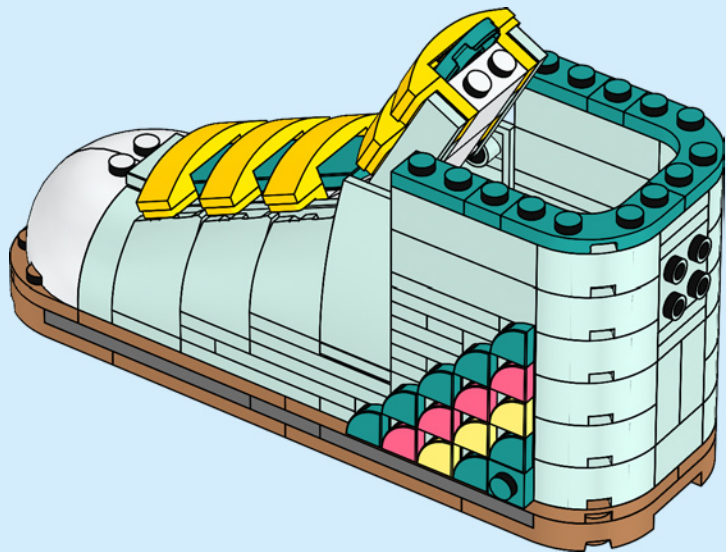



1x



1x

73

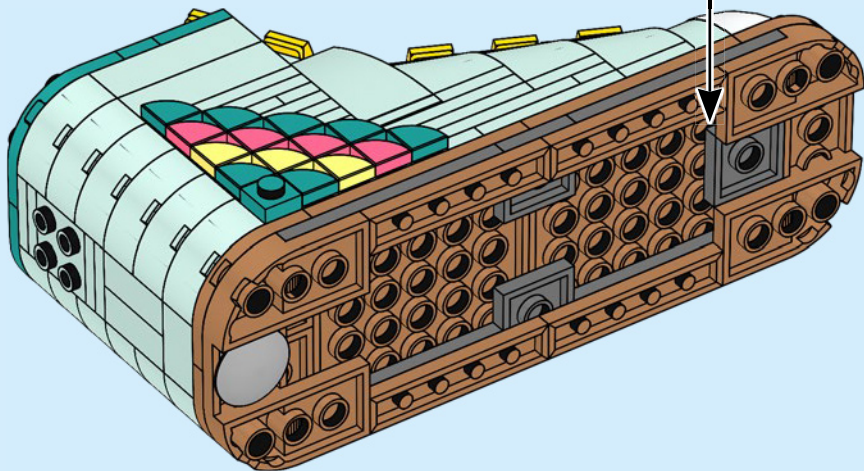

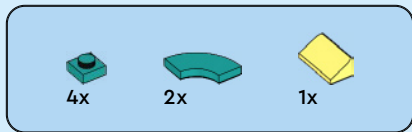

74

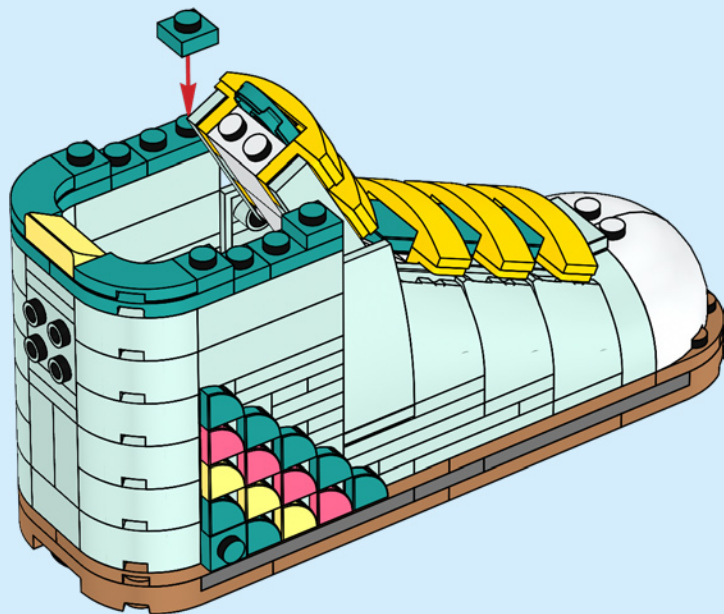
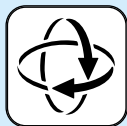

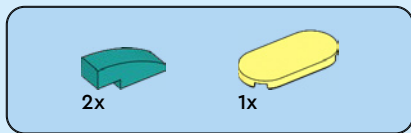

75

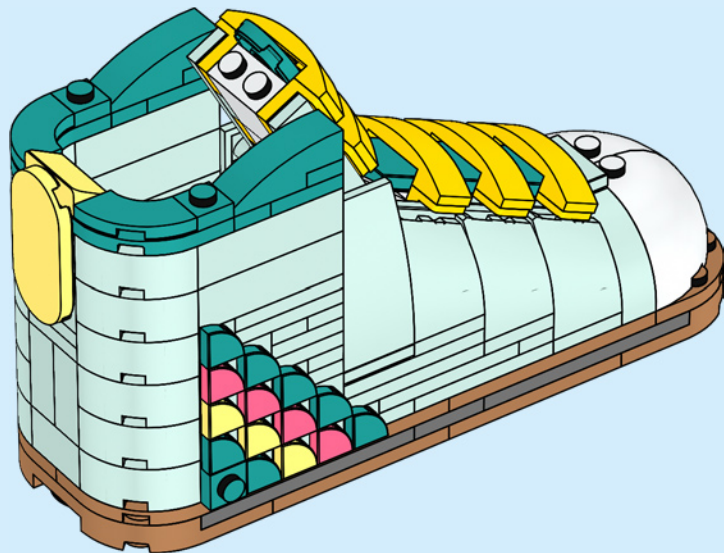

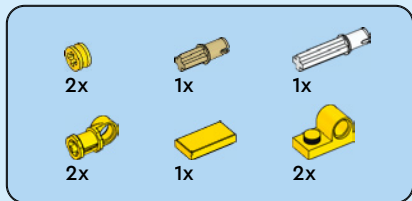

76

1

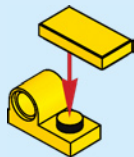

2

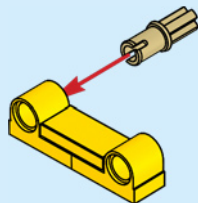

3

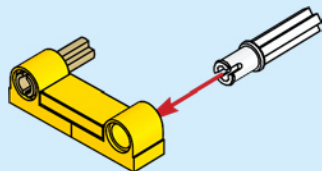

4

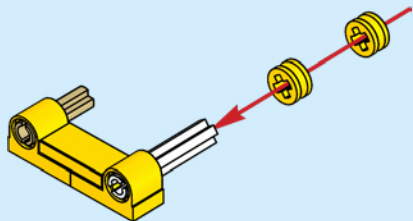

5

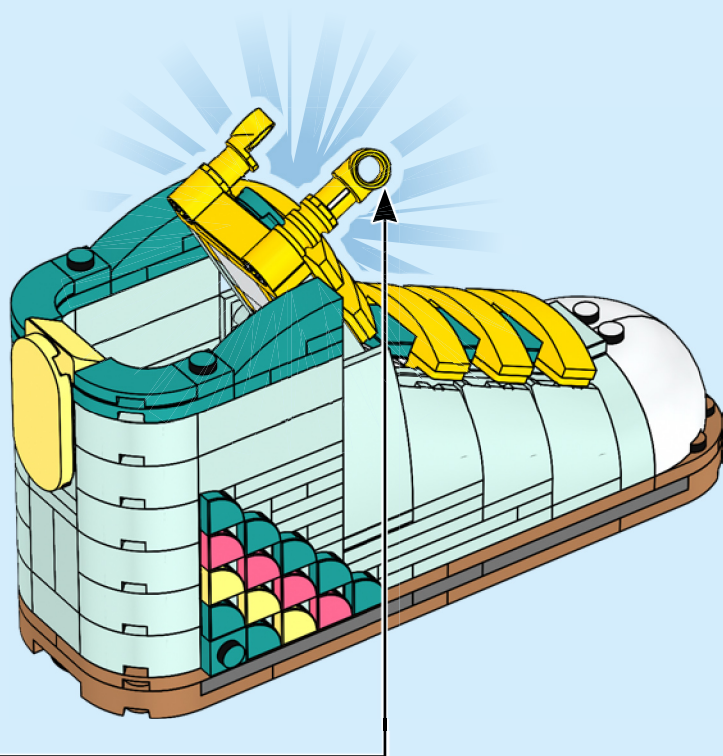
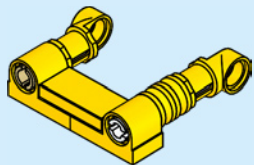

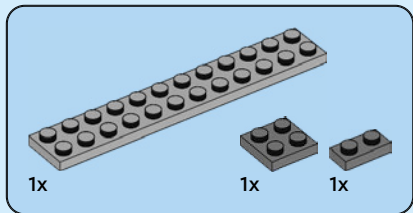
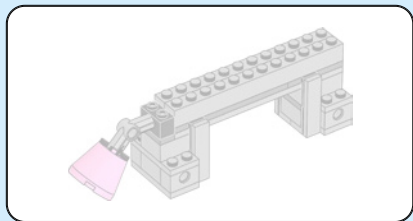

77

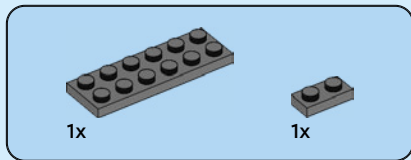
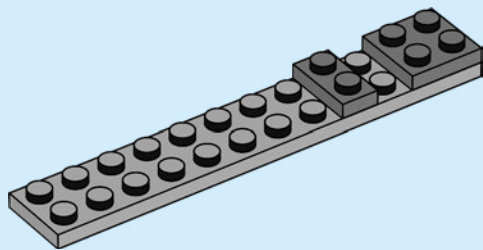

78

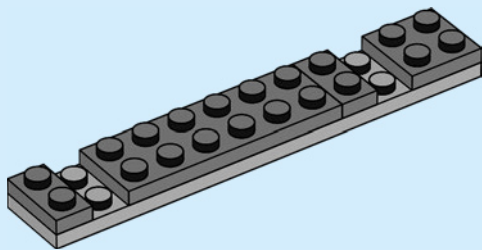

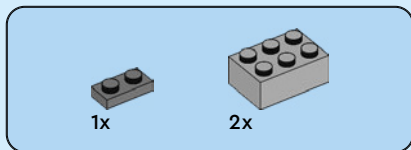

79

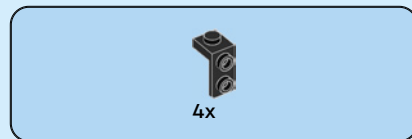
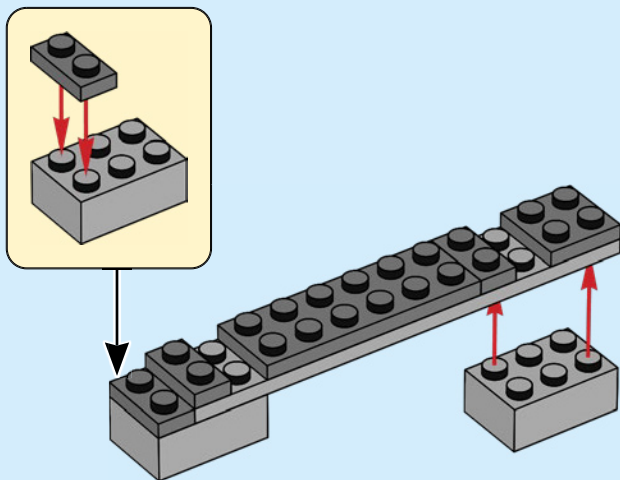

80

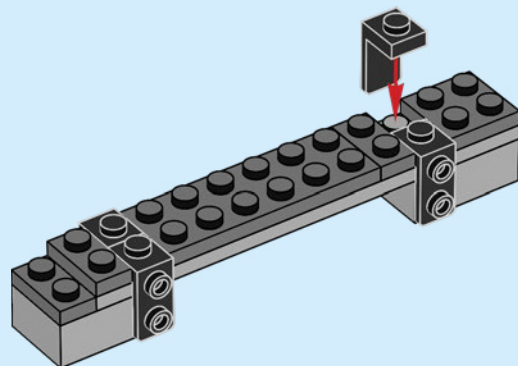

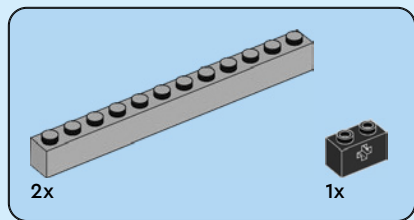

81

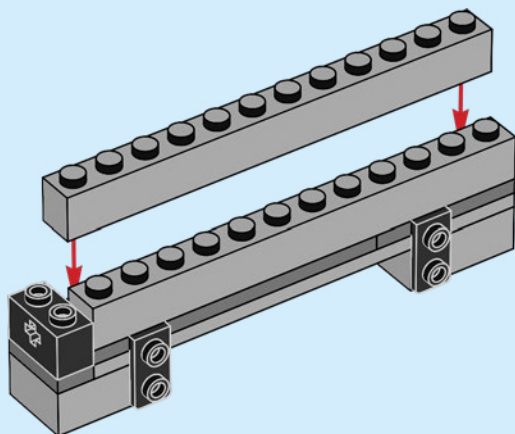



2x



2x



4x



4x



2x



4x

82

1

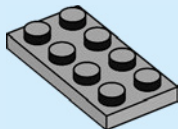

2

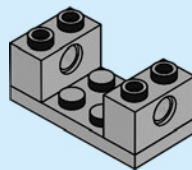

3

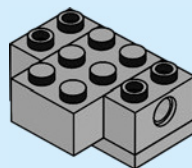

4

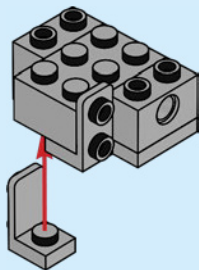

5

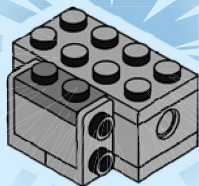

2x

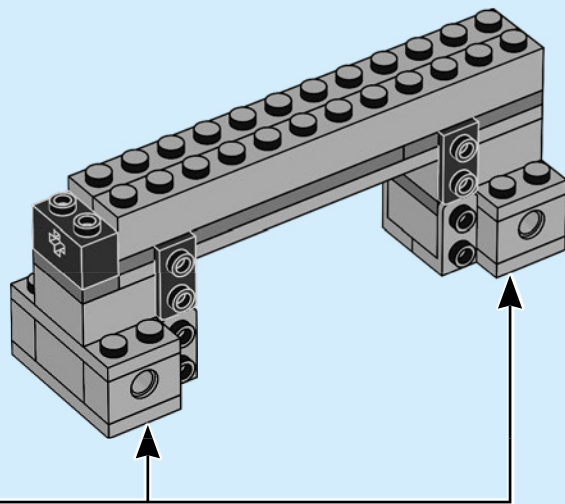

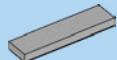

4x

83

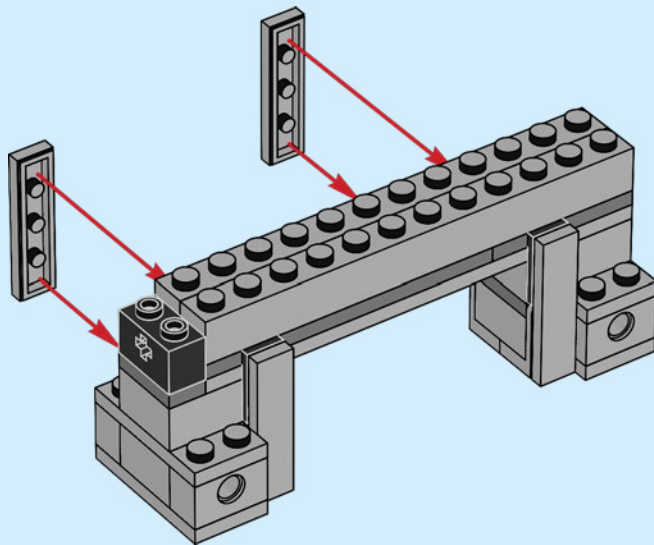

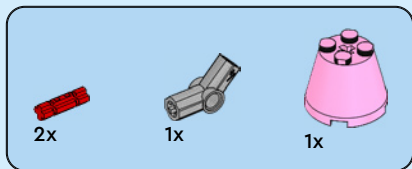

84

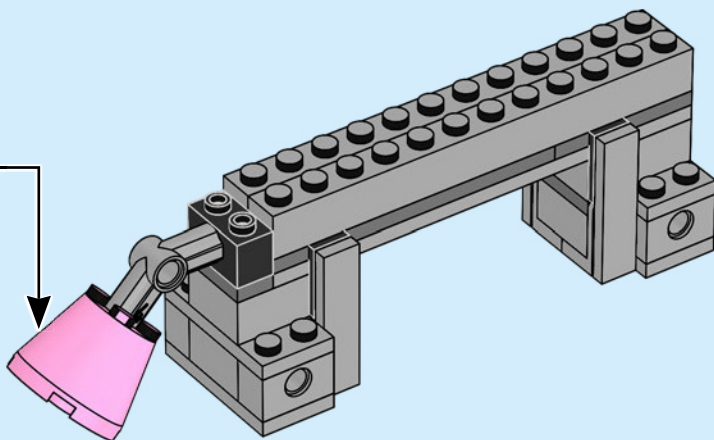
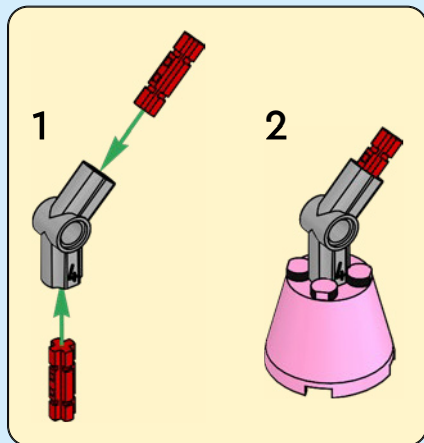

85

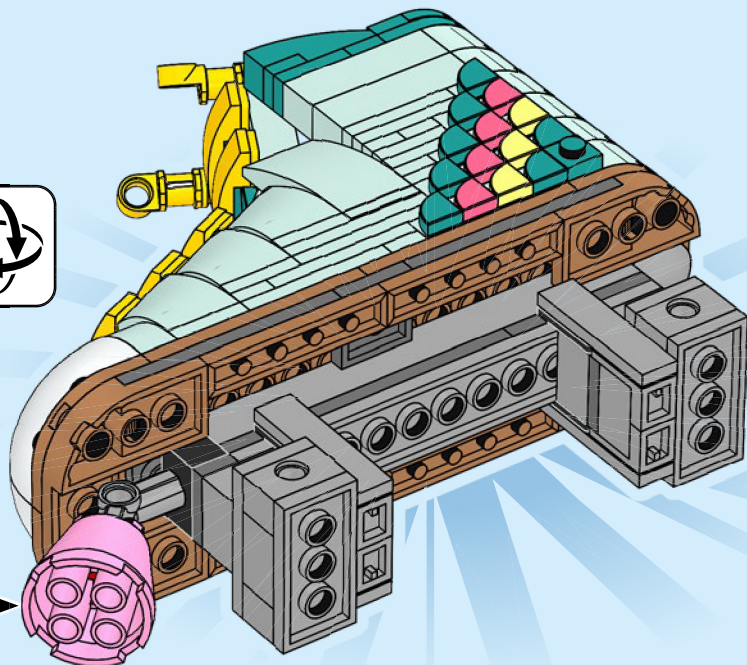
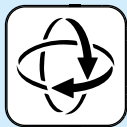



2x



1x



1x

86

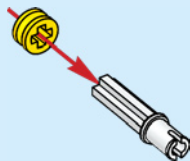

1x



1x

87

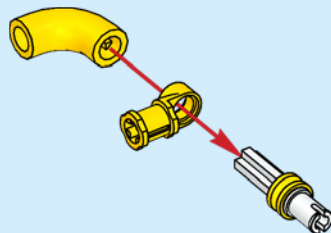

2x

88

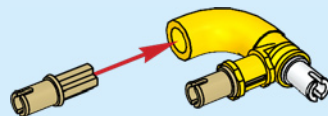



1x

89

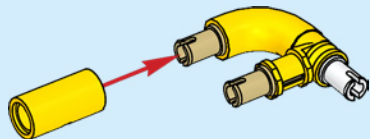

1x



1x



1x

90

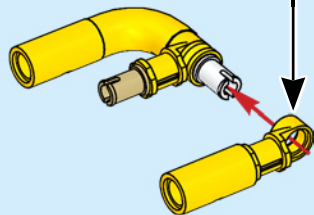
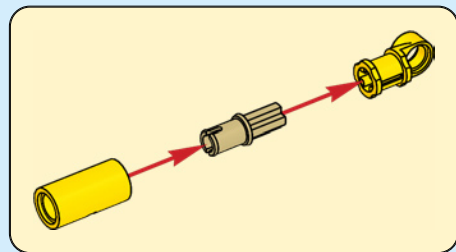

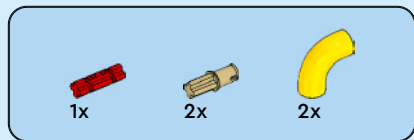

91

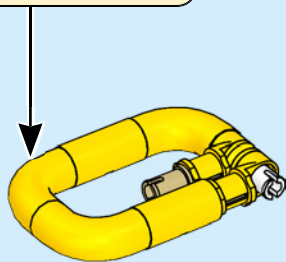
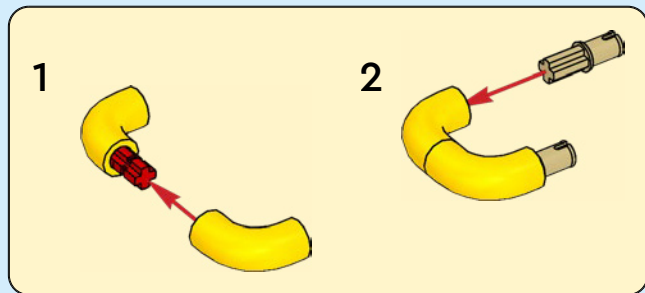

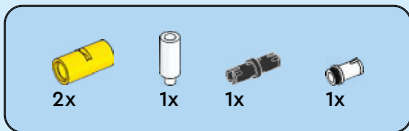

92

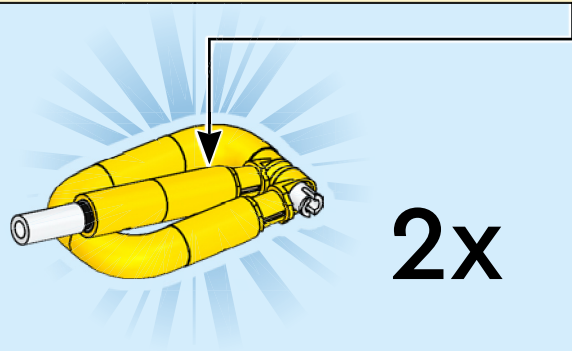
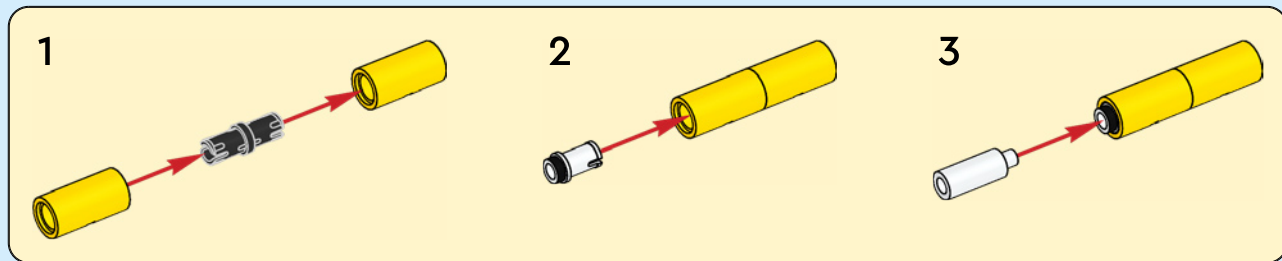

93

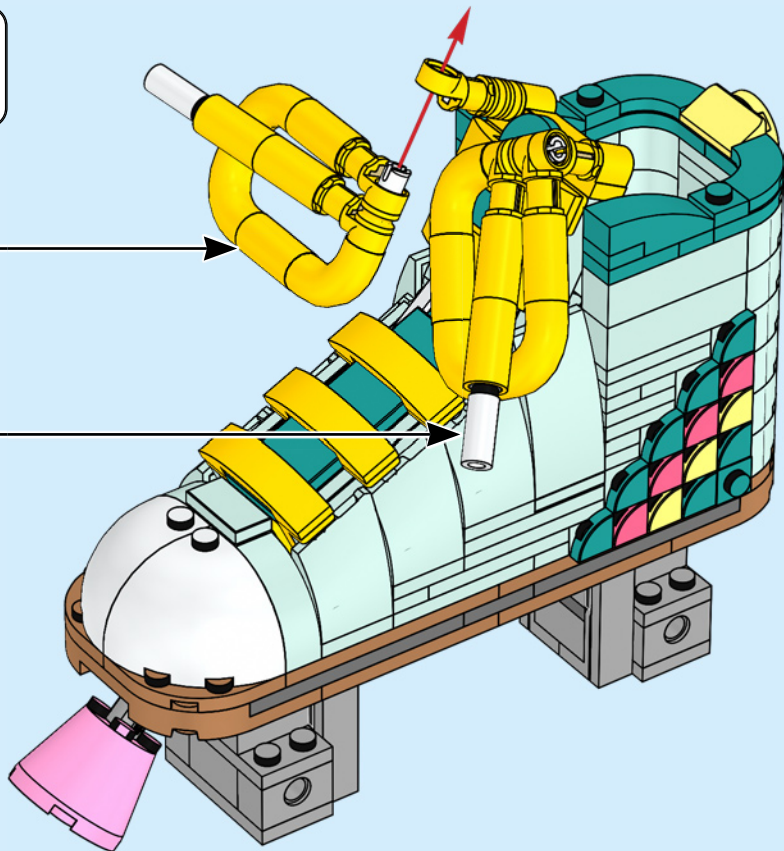
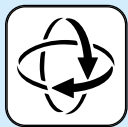



4x



1x



1x



1x

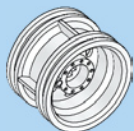

1x



1x

94

1

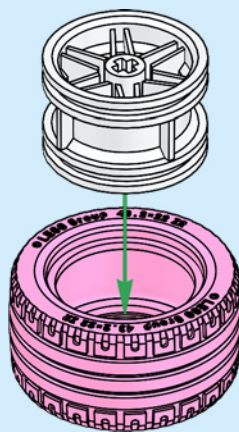

2

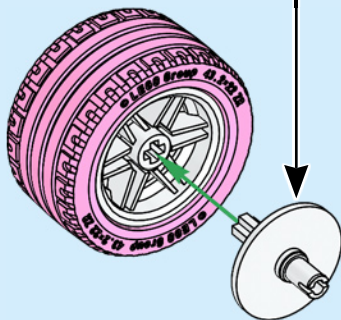
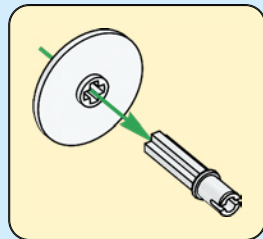

3

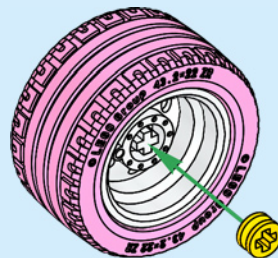

4x

95

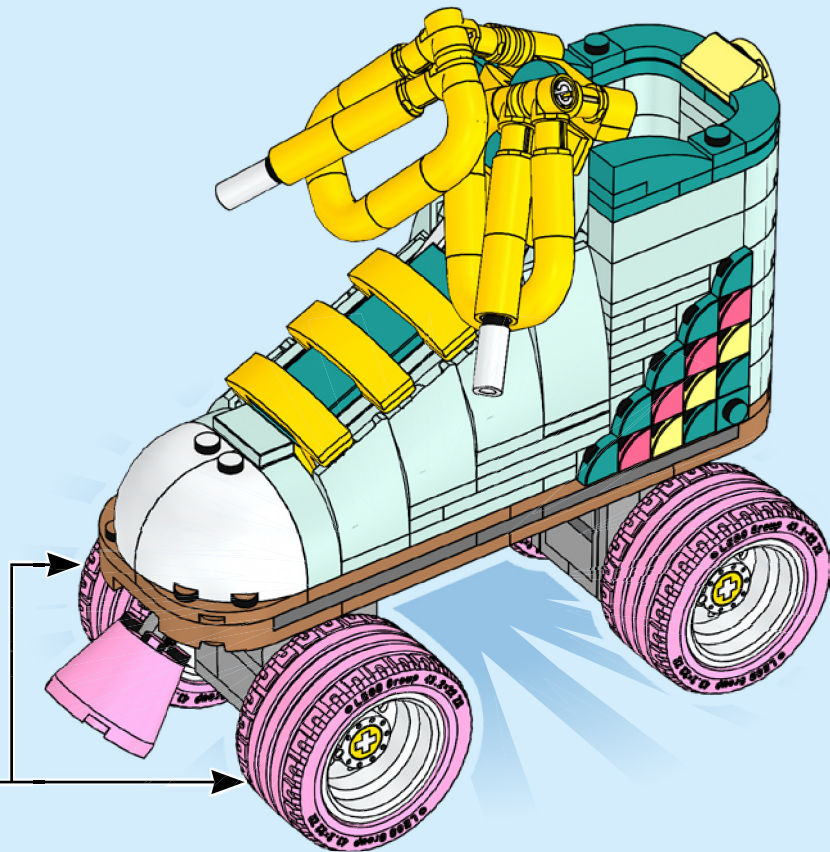

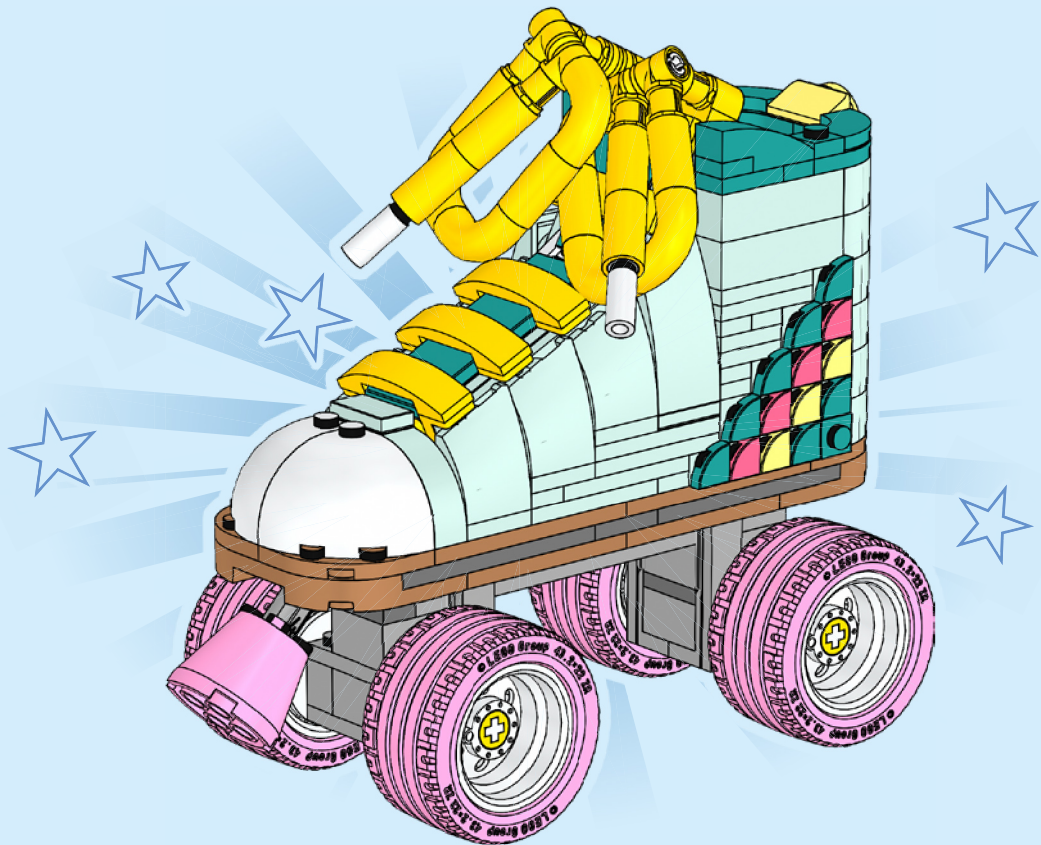

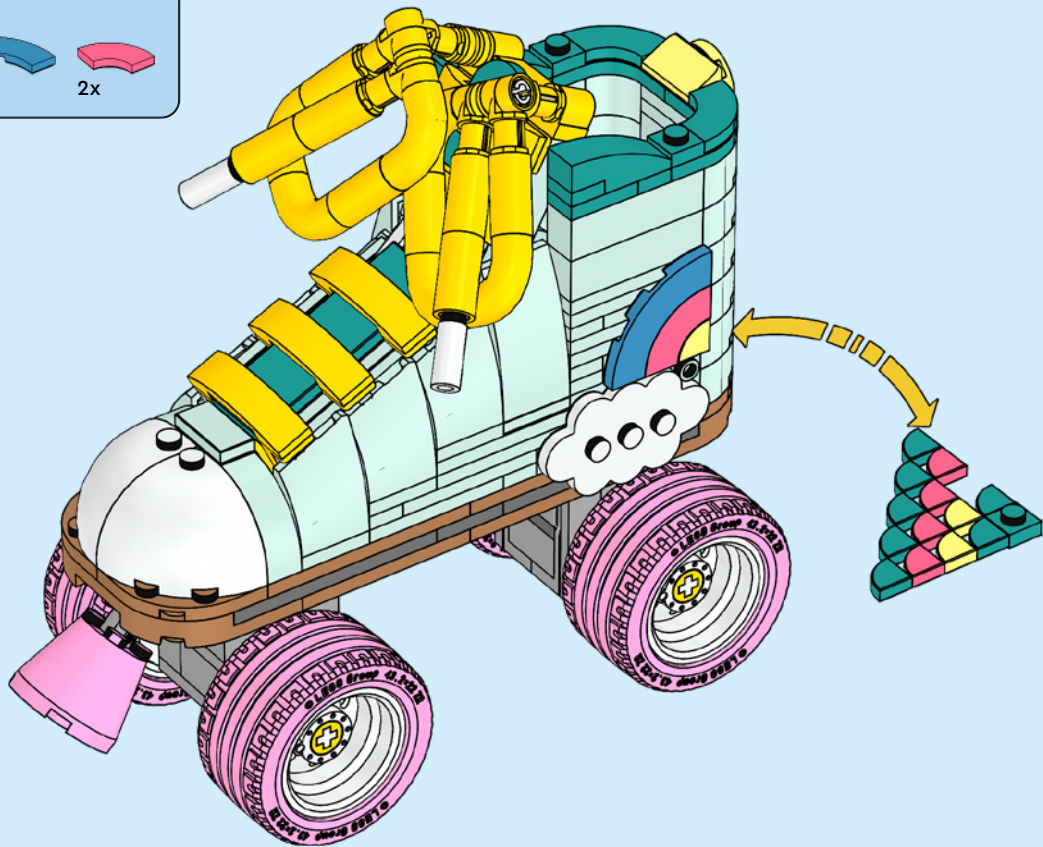
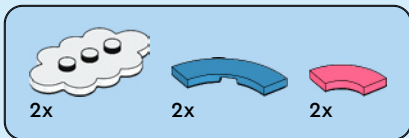

LEGO

CREATOR™

**3
IN
EN**

31152



31150



31146



31149

31147



31145



31148





Rebuild
the
world™



YOU COULD **WIN**



Scan this QR code or go to **LEGO.COM/PRODUCTFEEDBACK** and give us your short feedback about this LEGO® set for a chance to win a cool LEGO prize.

Terms and Conditions apply*

EN: YOU COULD WIN. Terms and Conditions apply* **DE: Du könntest GEWINNEN.** Es gelten die Teilnahmebedingungen* **FR: Tu pourrais GAGNER.** Des conditions s'appliquent* **IT: Potresti VINCERE tu.** Termini e condizioni sono applicabili* **ES: Puedes GANAR.** Aplican términos y condiciones* **PT: Poderá GANHAR.** Aplicam-se termos e condições* **ZH: 轻松获奖. 条款和条件适用*** **PL: Szansa na WYGRANĄ.** Obowiązują warunki korzystania* **CS: Máte šanci VYHRÁT.** Platí všeobecné smluvní podmínky* **SK: Máte šancu VYHRAŤ.** Platia všeobecné zmluvné podmienky* **HU: TE IS NYERHETSZ.** Felhasználási feltételek érvényesek* **RO: Ai putea CÂȘTIGA.** Se aplică termenii și condiții* **BG: Можете да СПЕЧЕЛИТЕ.** Има определени правила и условия* **LV: Tu vari LAIMĒT.** Ir spēkā noteikumi un nosacījumi.* **ET: Sul on võimalus VÕITA.** Kehtivad tingimused* **LT: Jūs galite LAIMĖTI.** Taikomos sąlygos*

*[LEGO.com/productfeedback-terms](https://www.lego.com/productfeedback-terms)

LEGO and the LEGO logo are trademarks of the/sont des marques de commerce du/son marcas registradas de LEGO Group.

©2024 The LEGO Group. 6497667