



**BRICK
HEADZ**

40622



[LEGO.com/brickheadz](https://www.LEGO.com/brickheadz)





1x

1

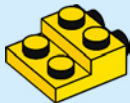

1x

2





1x

3

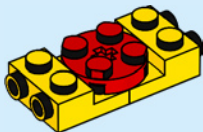

4

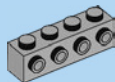

2x

4

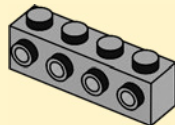

2x

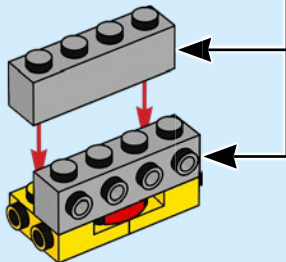



2x



4x

5

1



2



3



2x

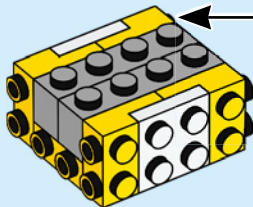



4x



8x

6

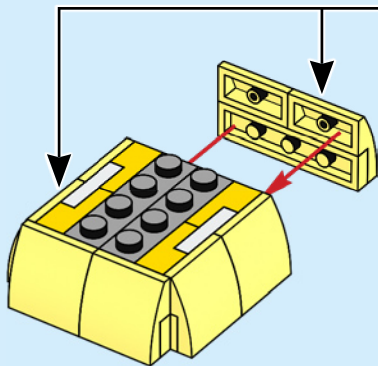

1

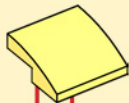
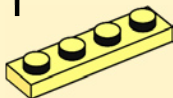

2

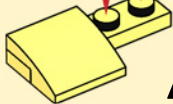

4x

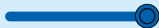

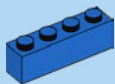

2x

7

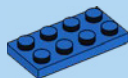
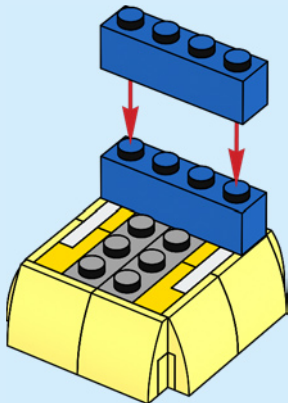

1x

8

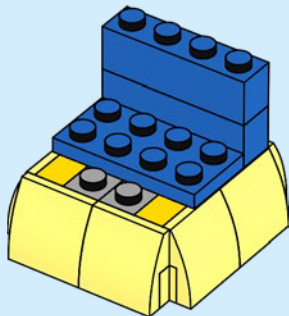



2x



1x

9

1

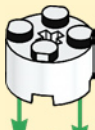

2

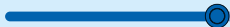
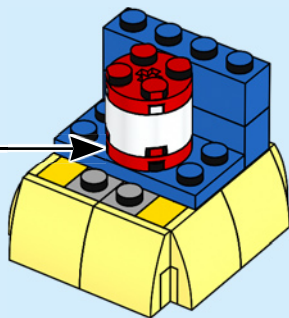



2x

10

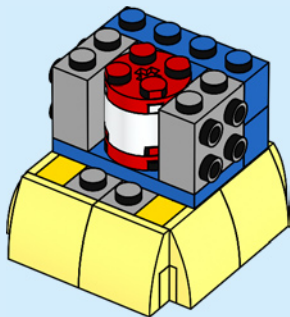

1x

11

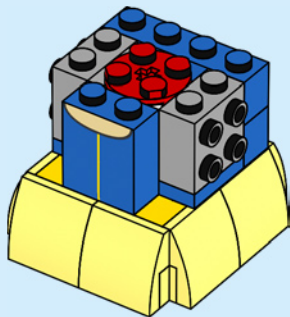



1x



1x

12

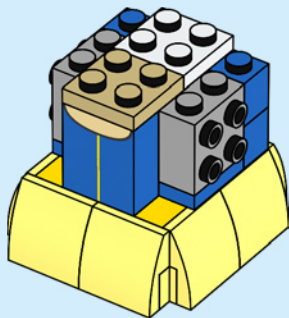

1x



1x

13

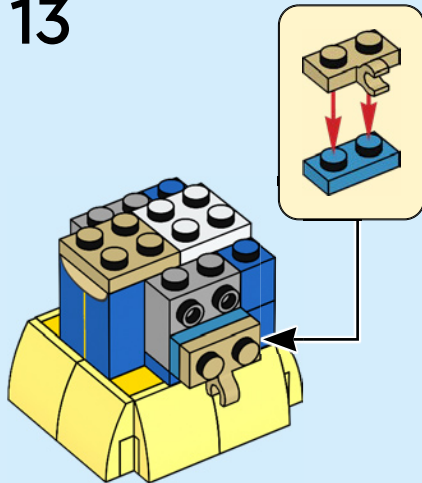



1x

14

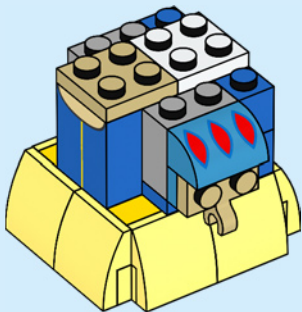

1x



1x

15

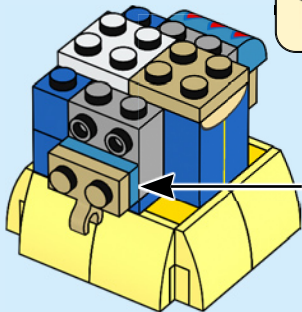
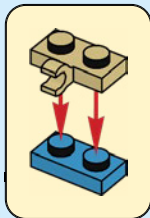
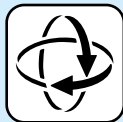



1x

16

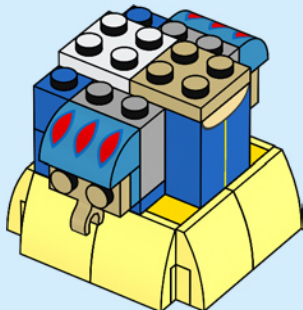

1x



1x

17

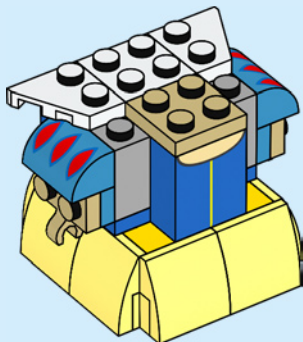



4x



2x

18

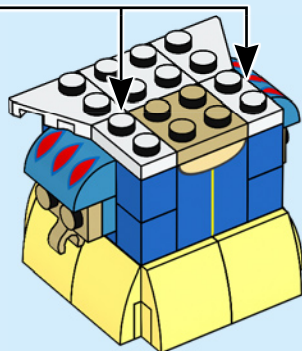
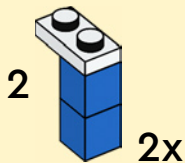
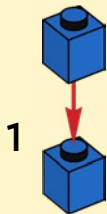



3x

19

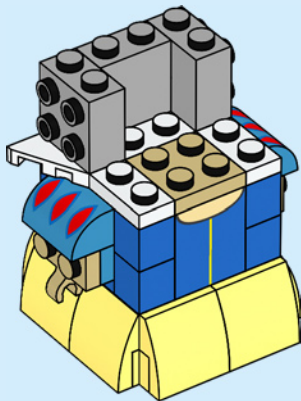

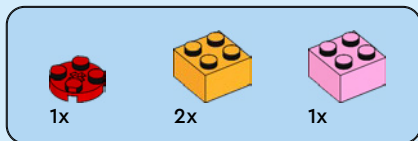

20

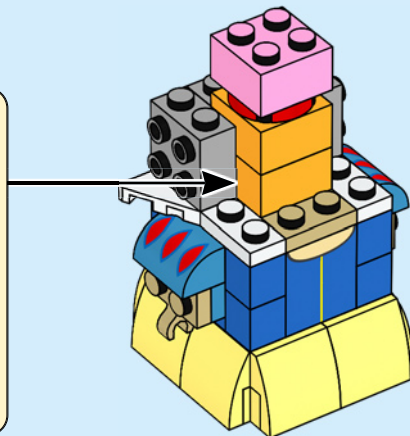
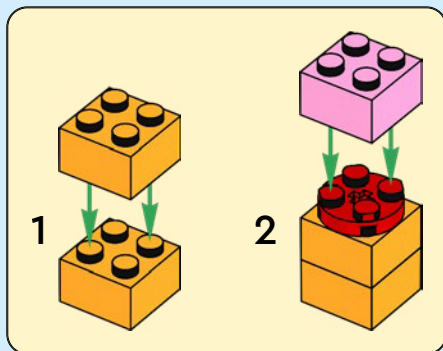



3x

21

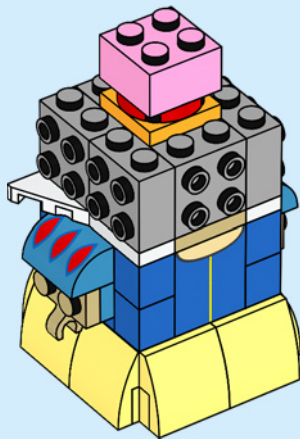



6x

22

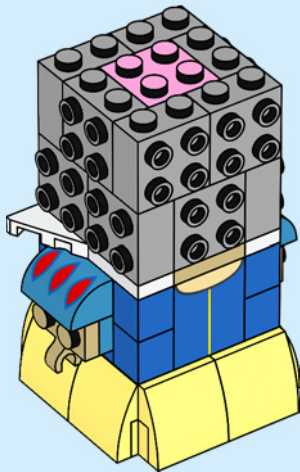



1x



2x

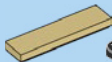

2x



2x

23

1

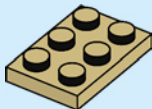

2

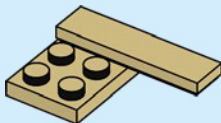

3

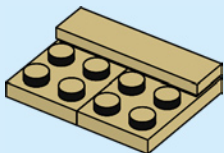

4

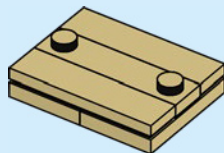

5

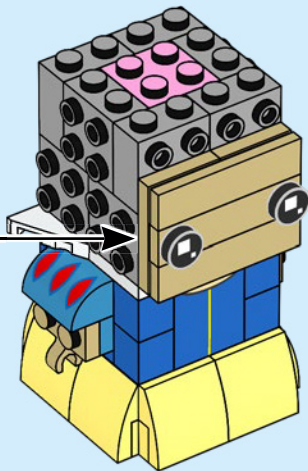
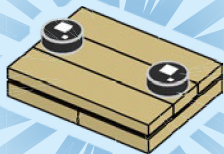



2x



1x



2x



2x



2x

24

1

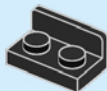

2



3

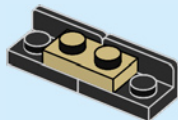

4

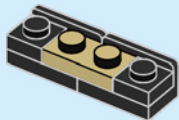

5

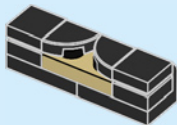

6

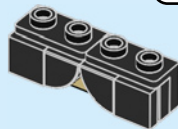

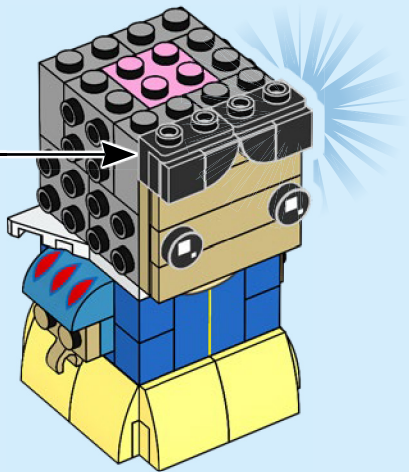



1x



1x

25

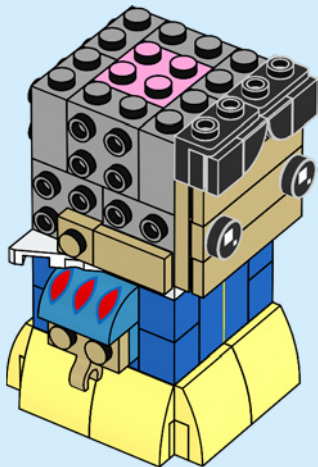



1x



1x



1x

26

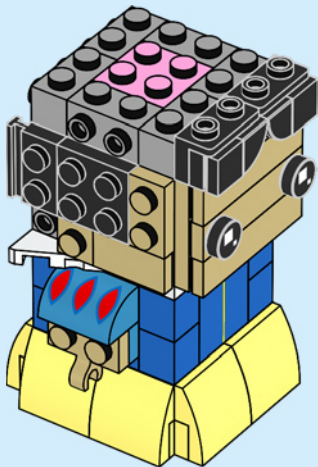



1x

27

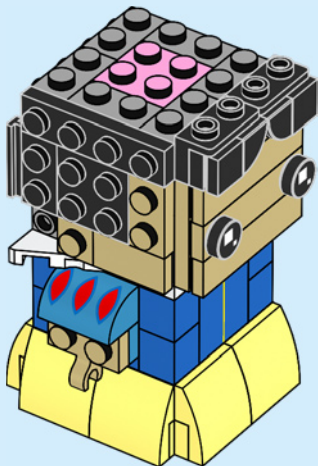

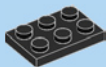

1x



1x

28

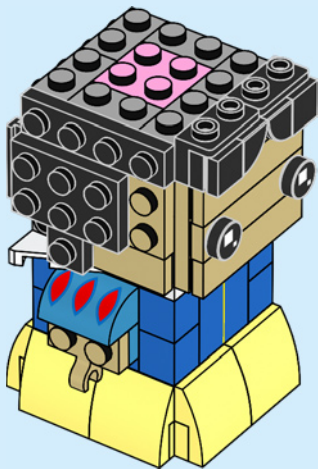



1x

29

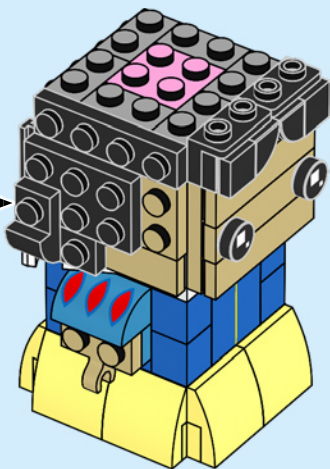



1x



1x

30

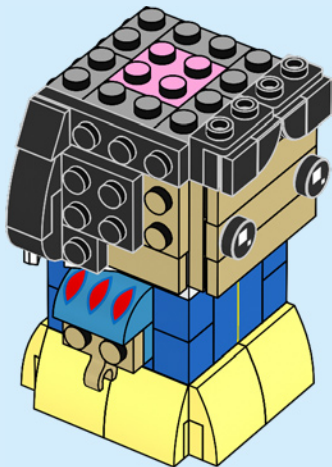



1x



2x

31

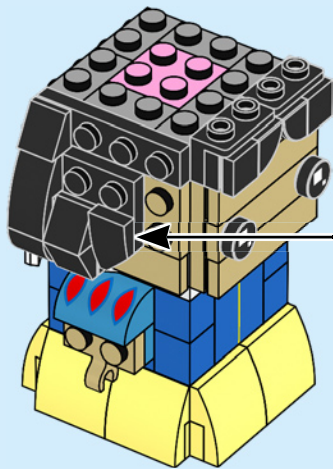



1x

32

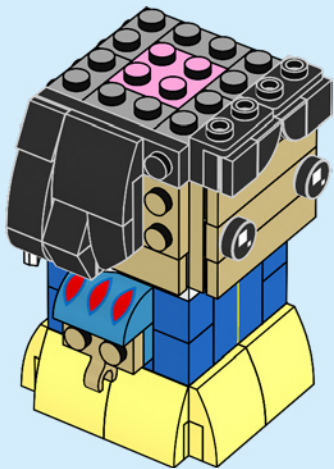



1x



1x



1x

33

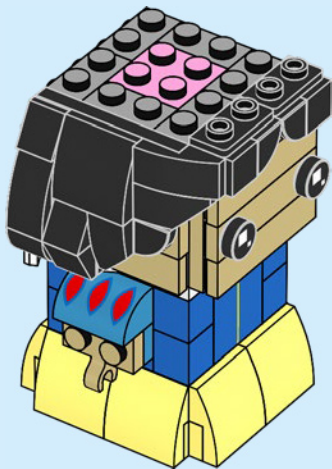

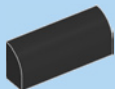

1x

34

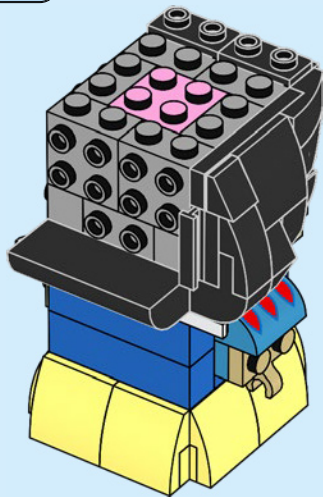
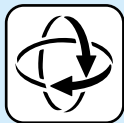

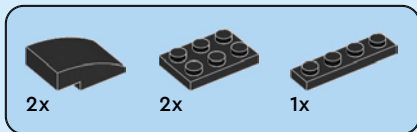

35

1

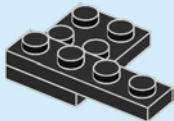

2

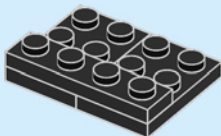

3

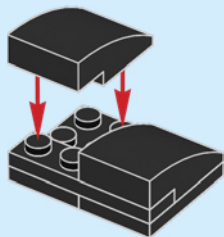

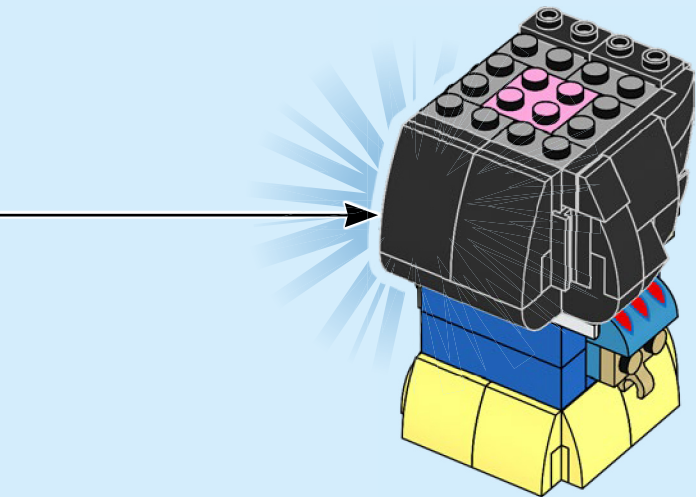



1x



1x

36

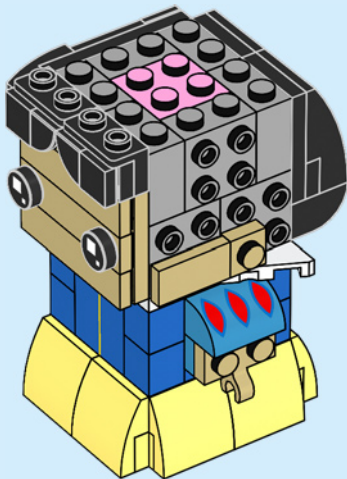



1x



1x



1x

37

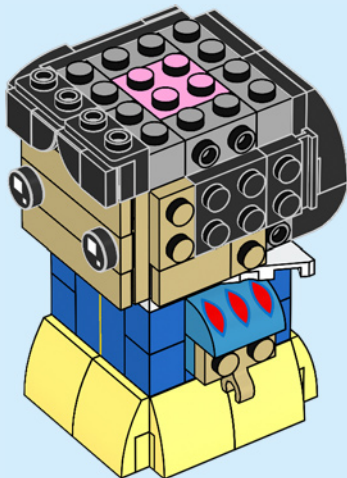



1x

38

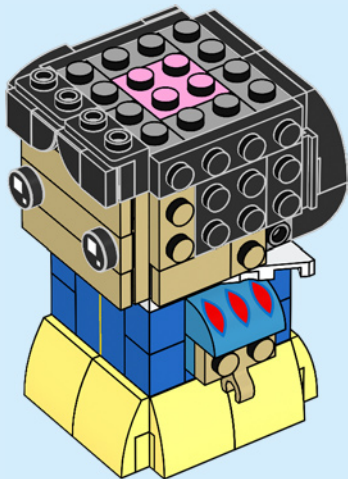

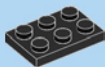

1x



1x

39

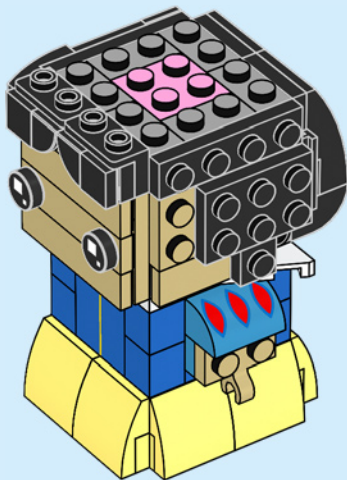



1x

40

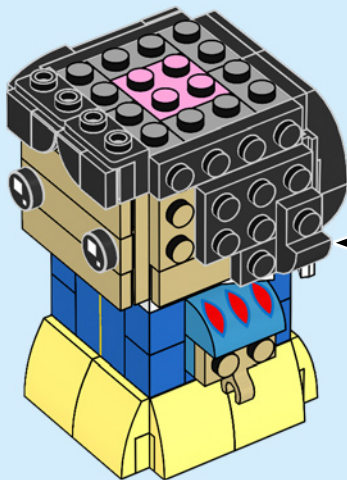



1x



1x

41

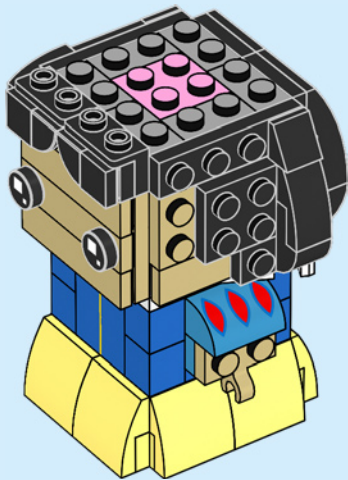



1x



2x

42

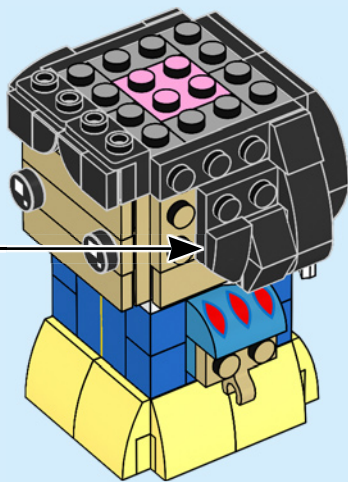



1x

43

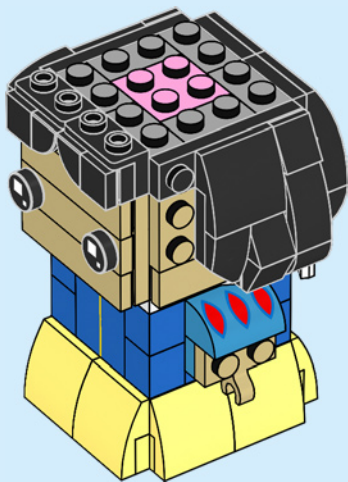



1x



1x



1x

44

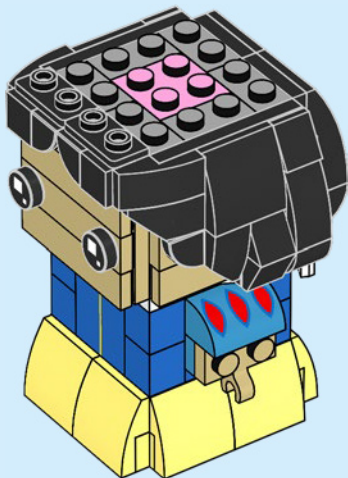

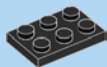

1x

45

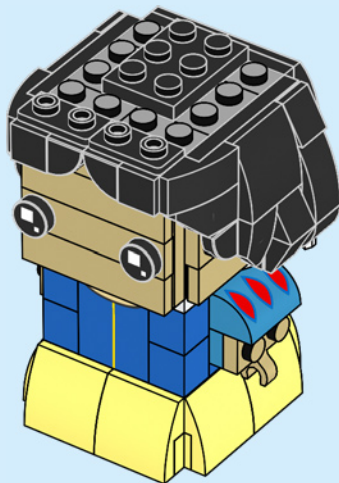



2x



2x

46

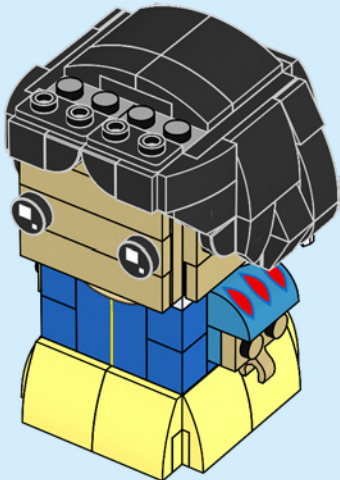



4x



1x



1x

47

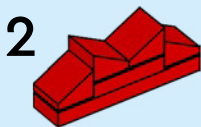
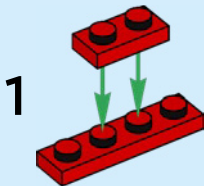

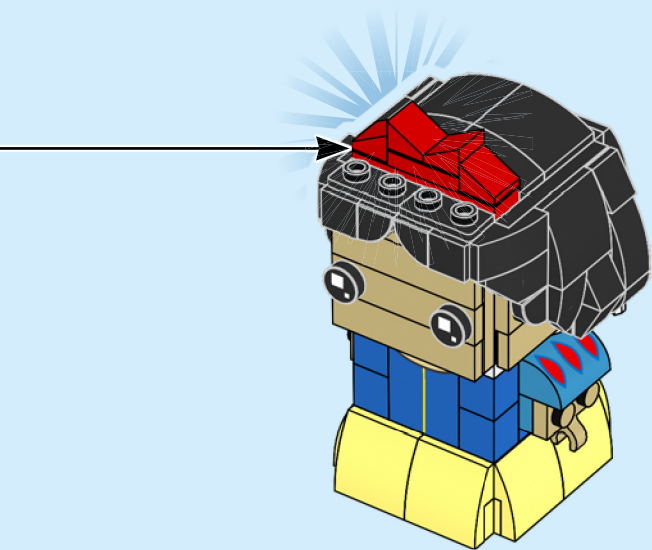

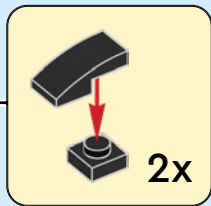
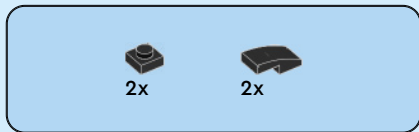

48

