

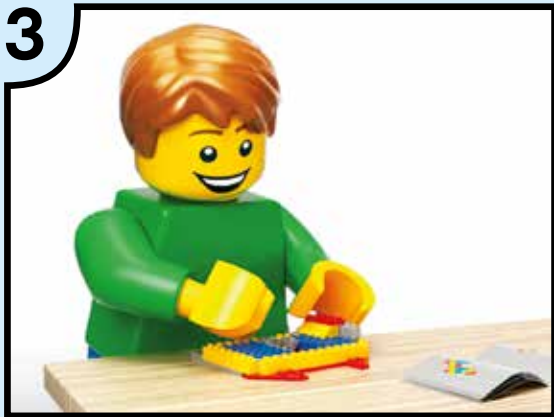

ELVES

41196





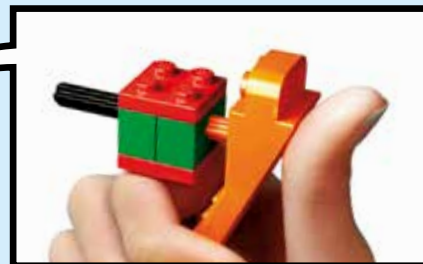

LEGO.com/brickseparator

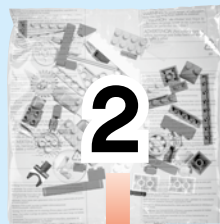

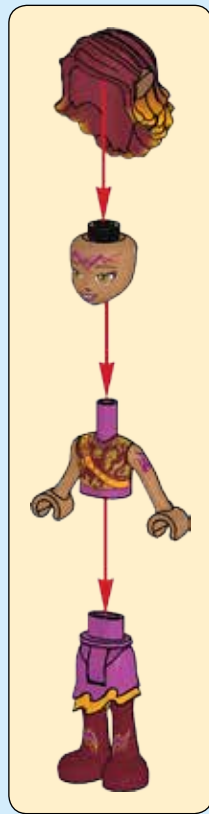
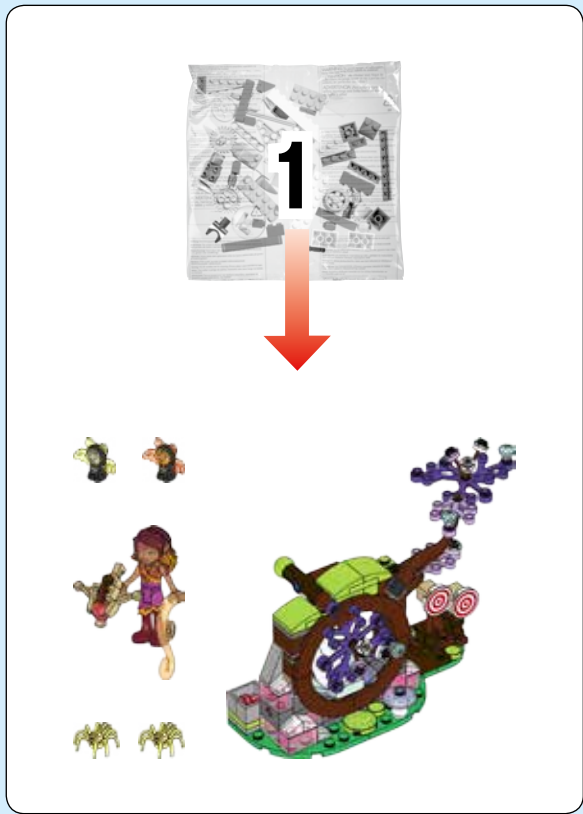

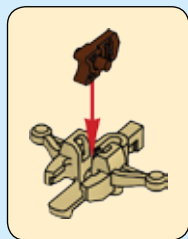



1

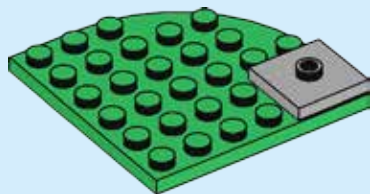



1x



2x

2

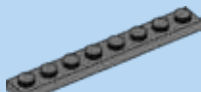
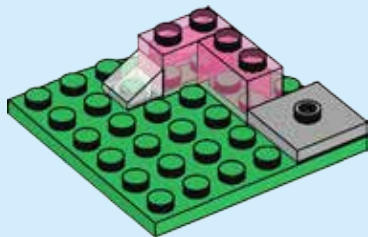

1x

3

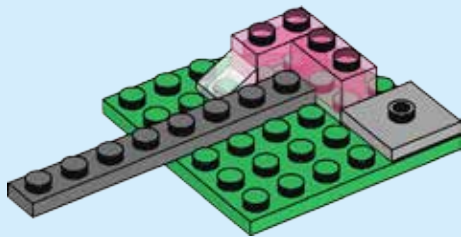



4

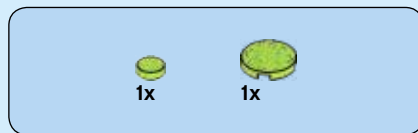
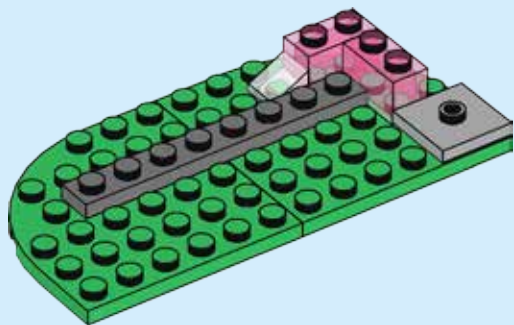

5

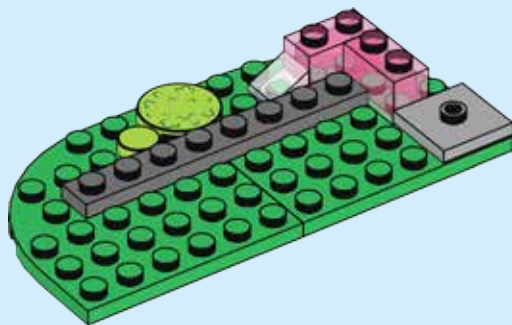

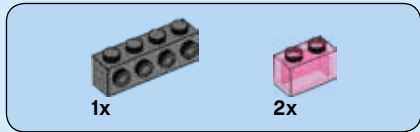

6

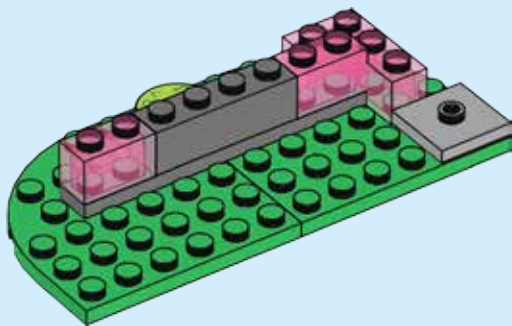

7

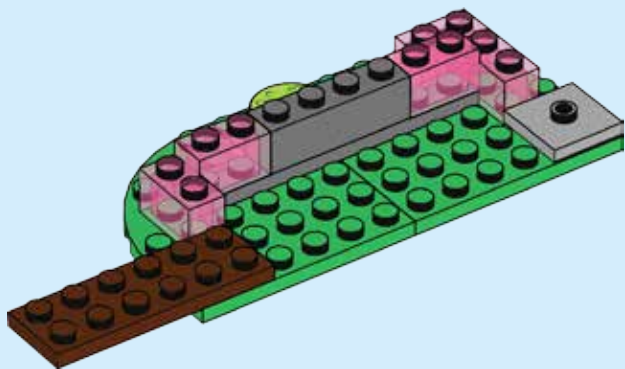



1x

8

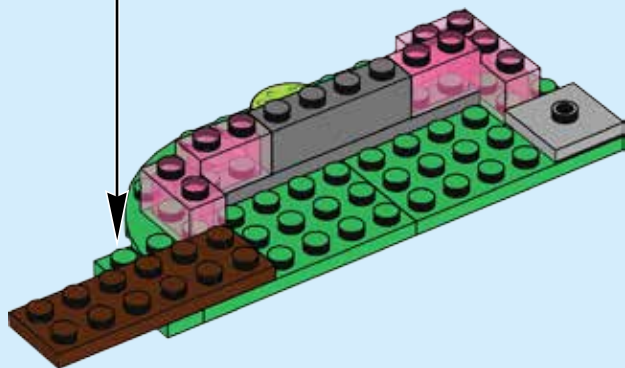
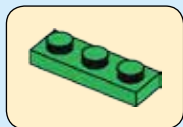

1x

9

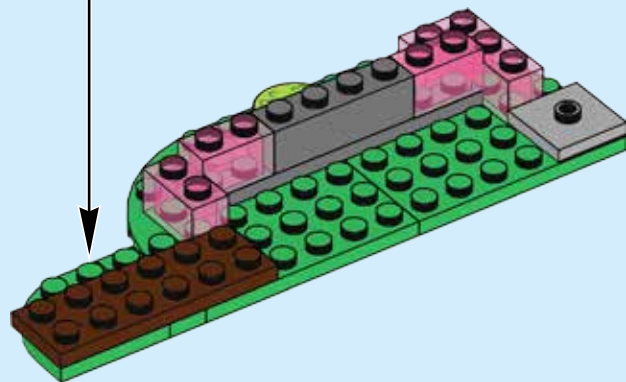



10

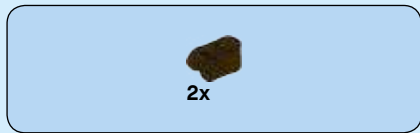
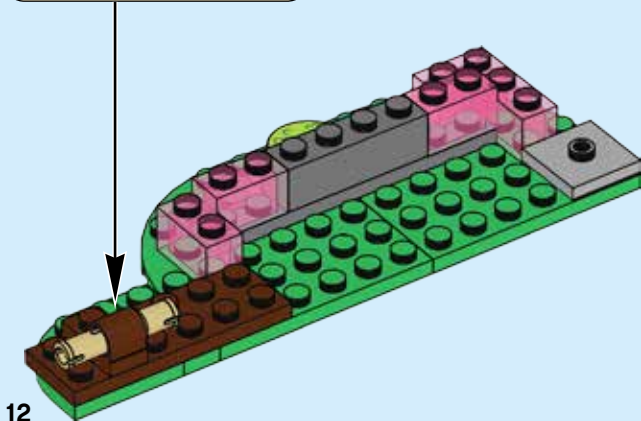
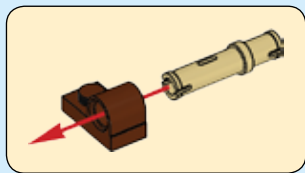

11

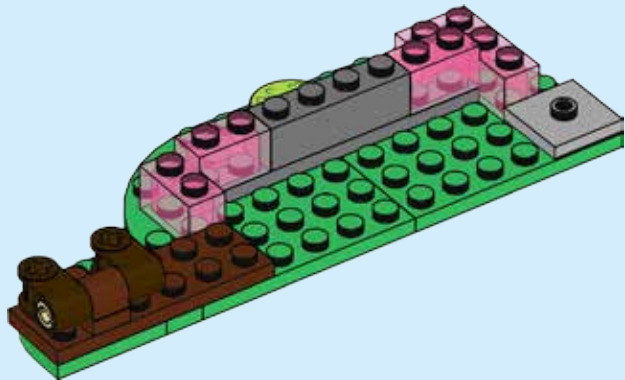

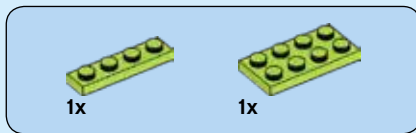

12

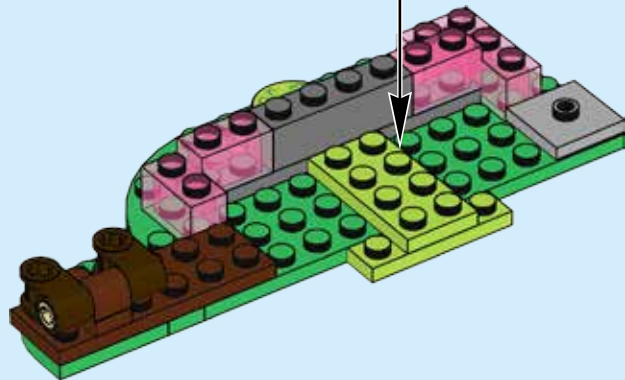
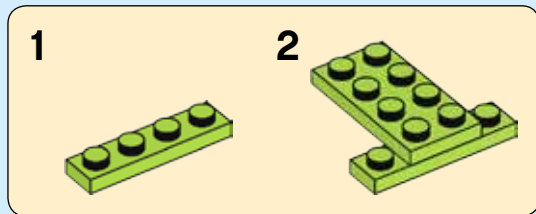

13

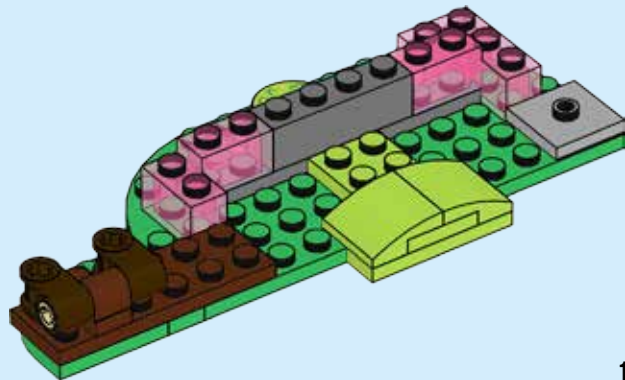

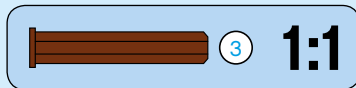
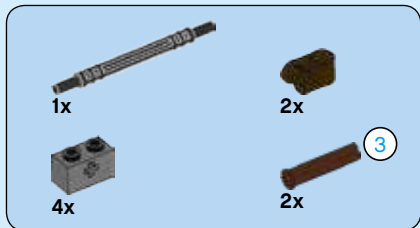

14

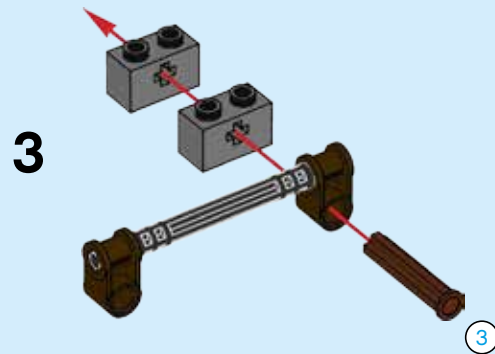
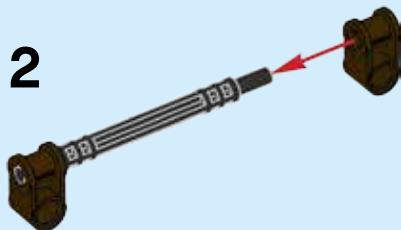

4

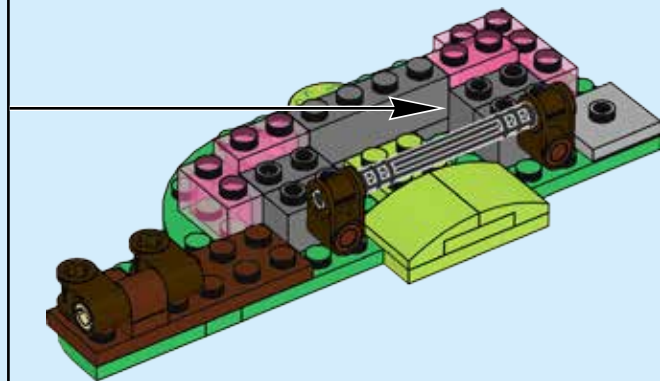
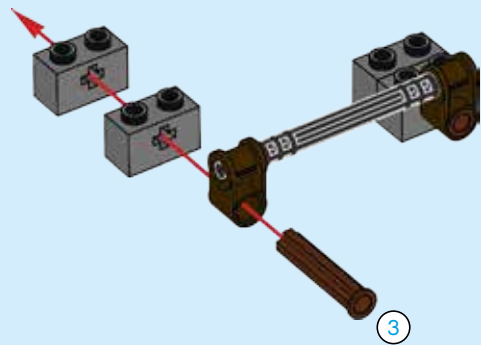



1x



2x

15

1



2

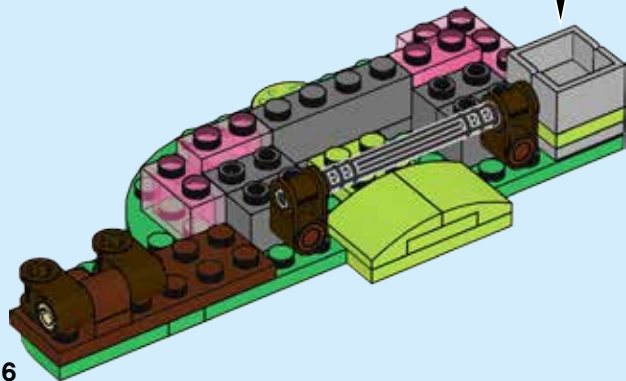
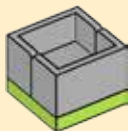

16



2x

16

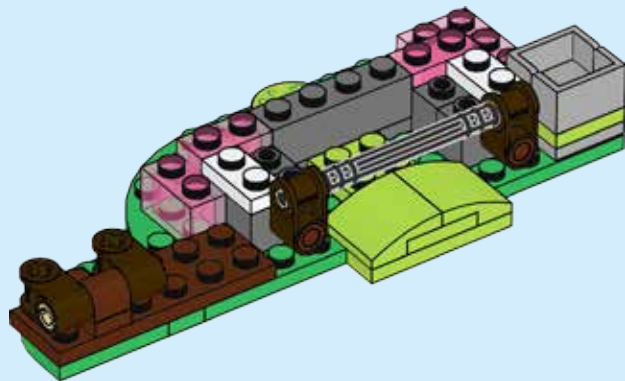

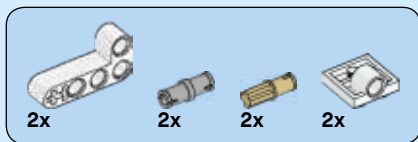
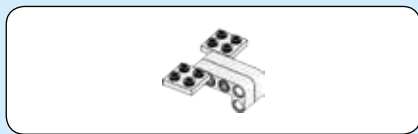

17

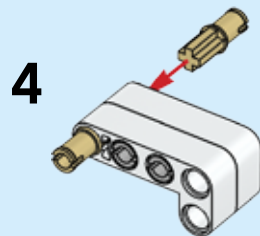
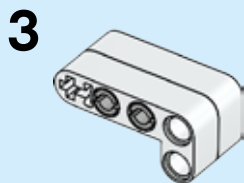
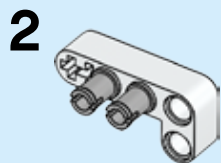
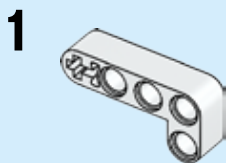



5

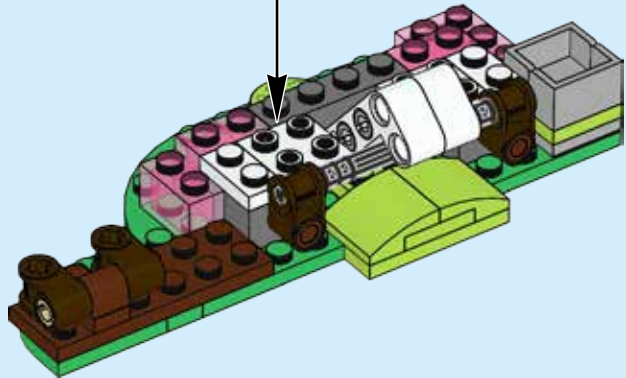
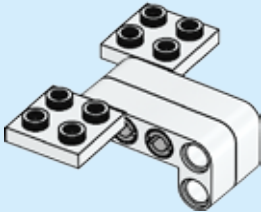



2x



2x

18

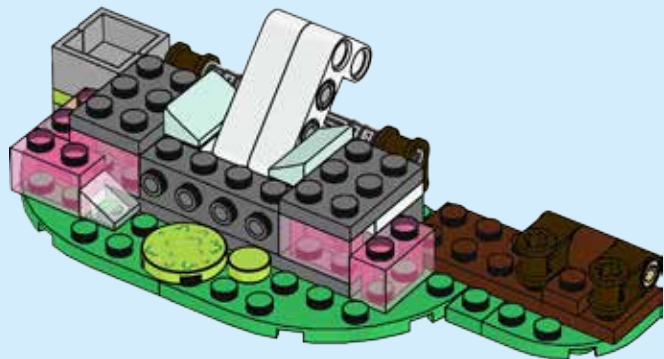
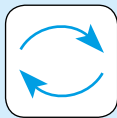

2x

19

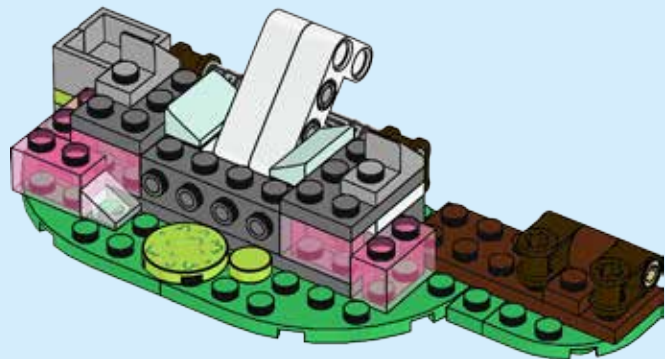

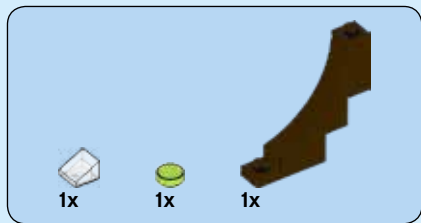

20

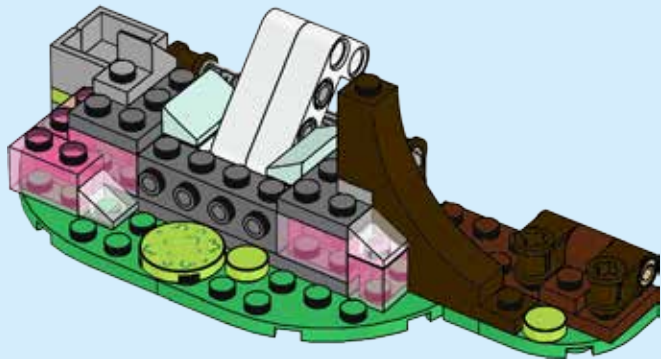

20

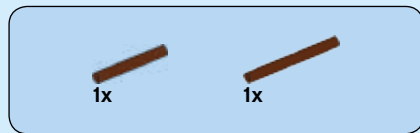

21

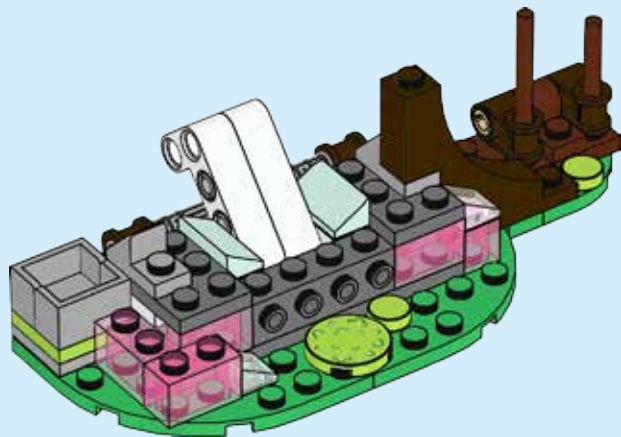



2x



2x

22



1



2



2x

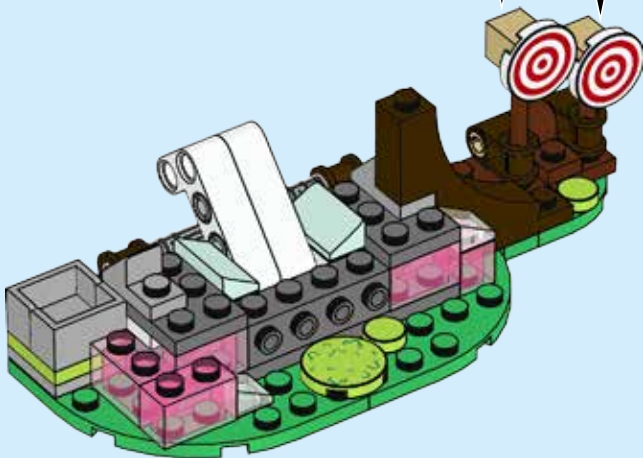



2x



1x

23

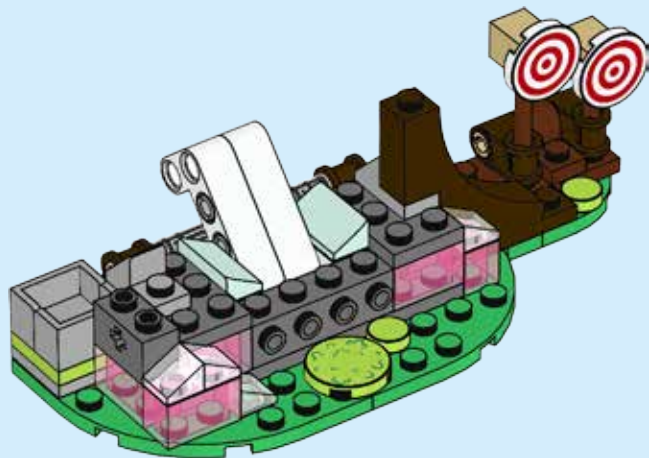

22



1x



1x

24

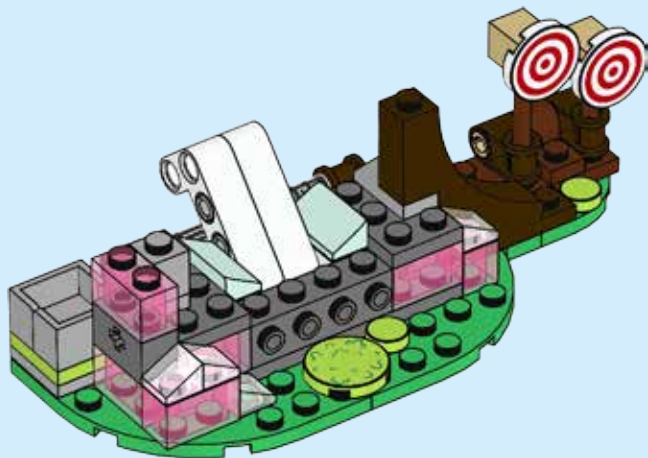

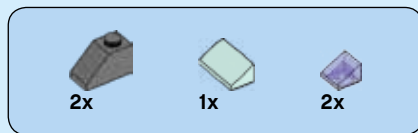

25

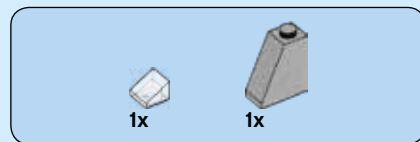
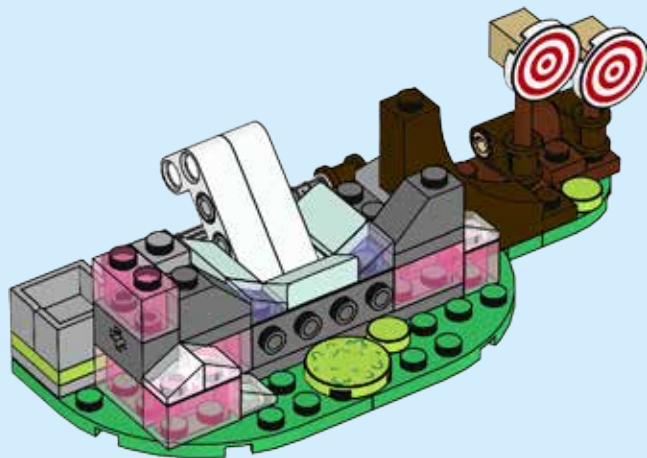

26

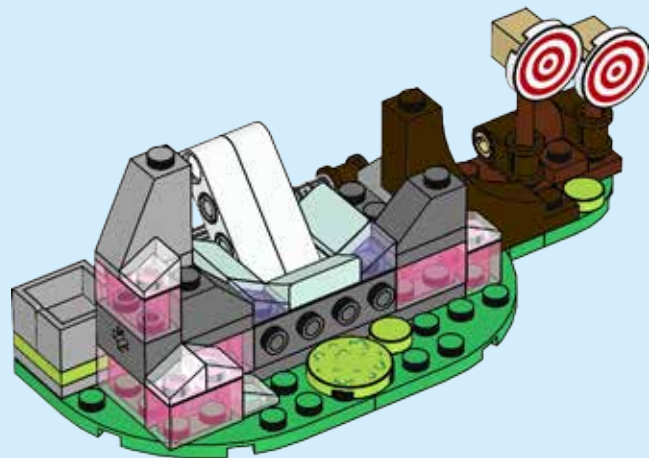



4x



2x

27

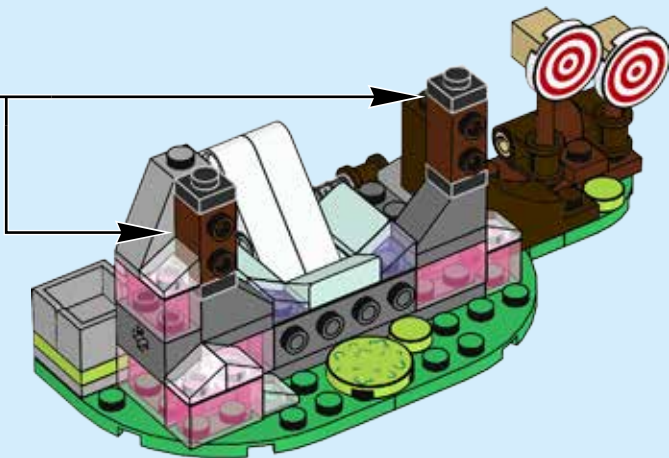
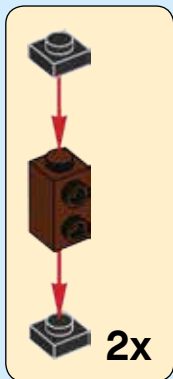



28

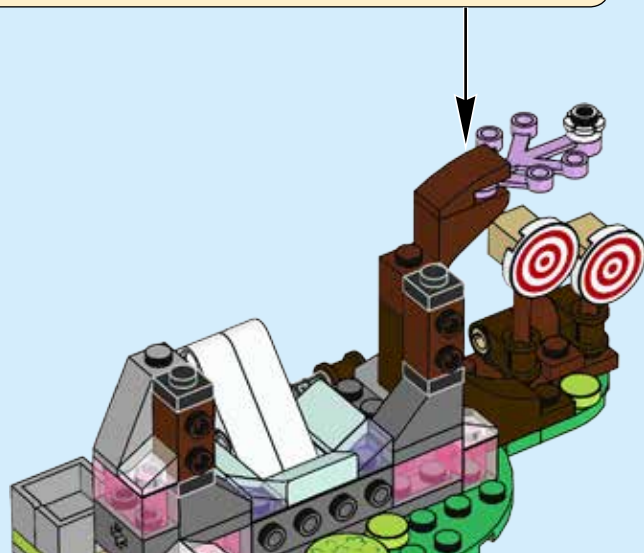
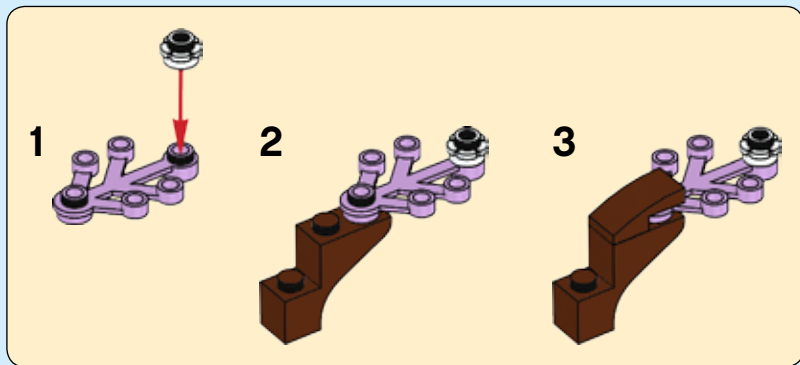



2x

29

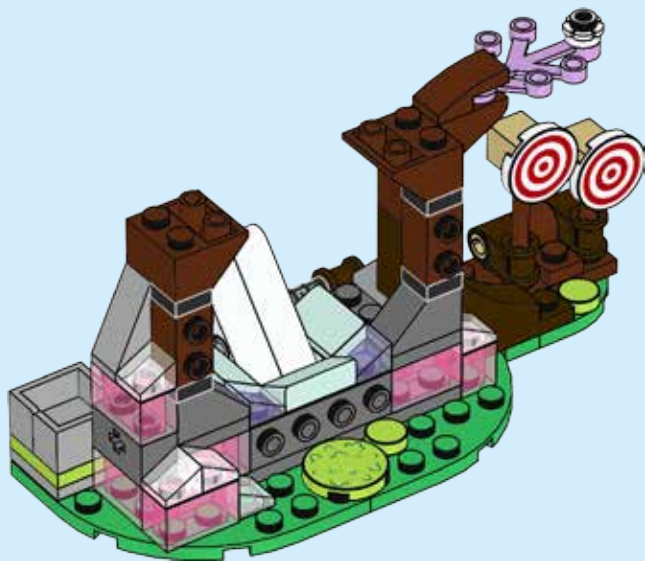

26



1x

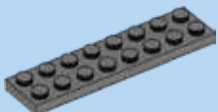

1x

30

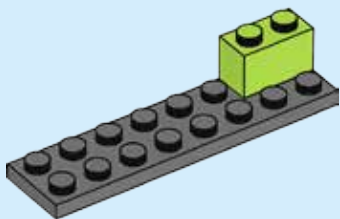

1x



1x



1x

31

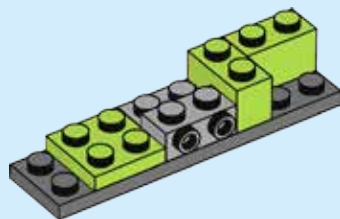



1x

34

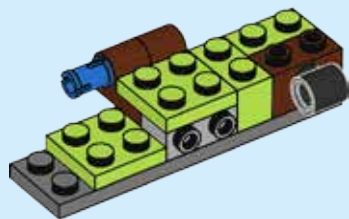

1x



2x

35

1



2

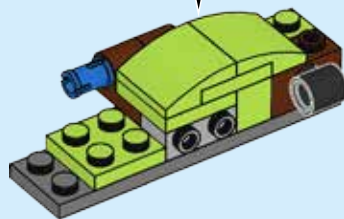
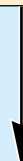

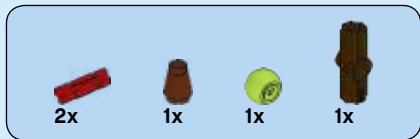

36

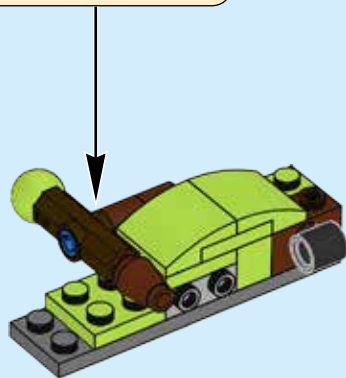
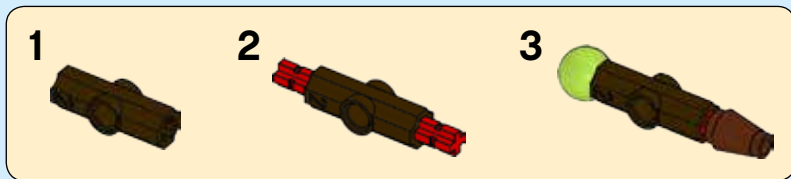



1x

37

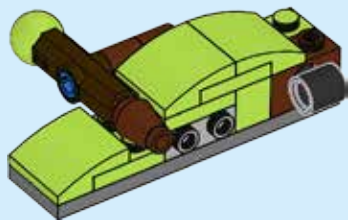

38

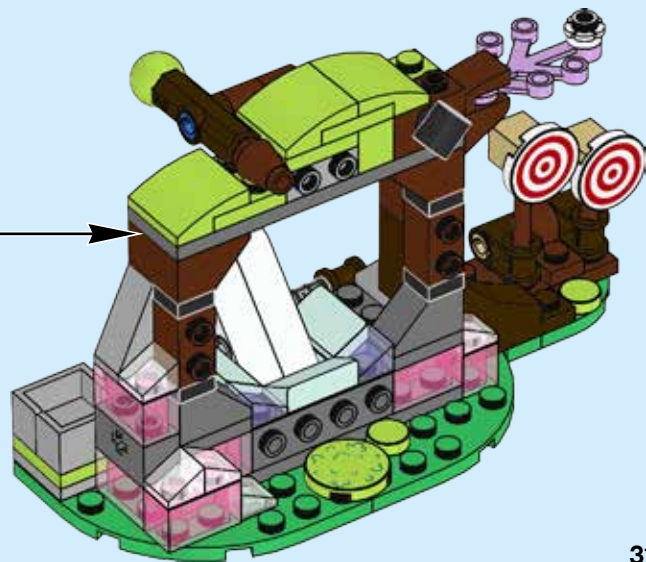

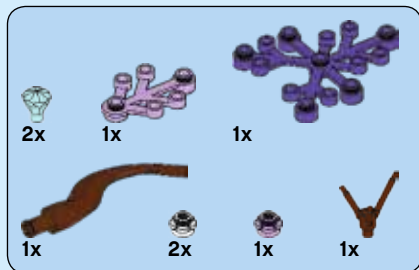

39

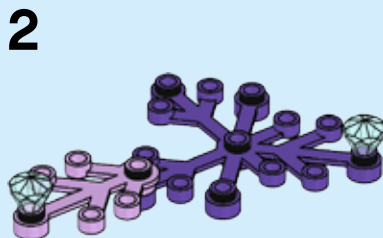
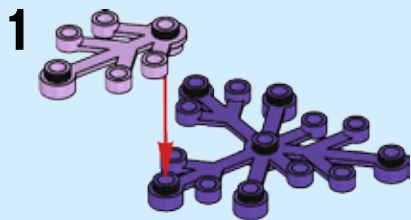

4

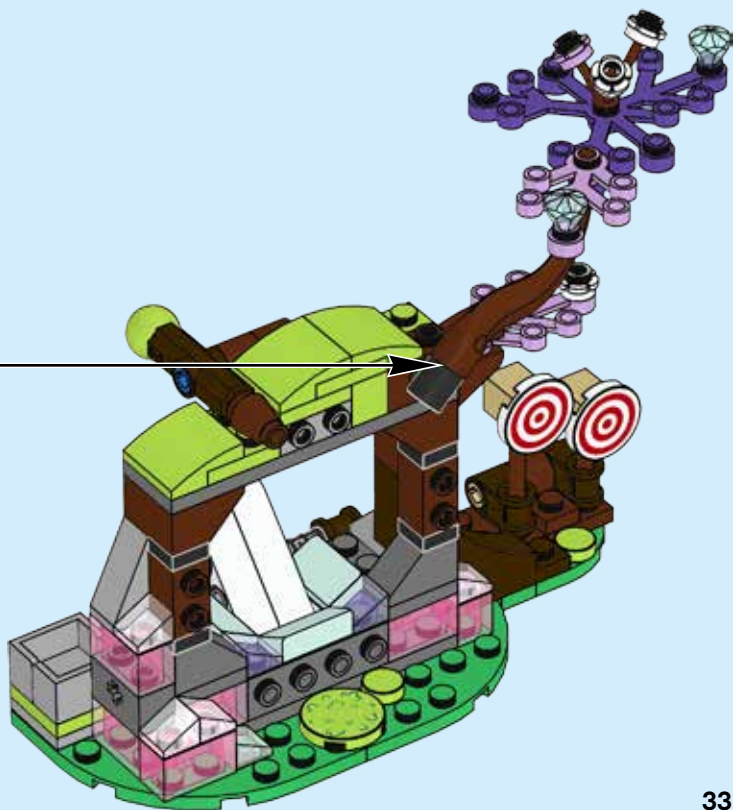
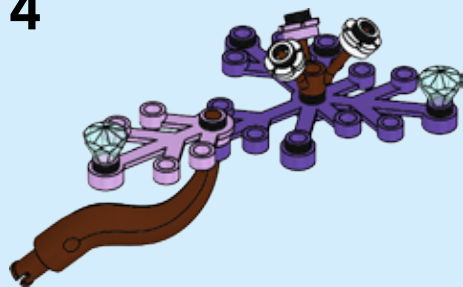



4x

40





41

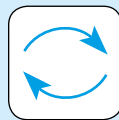
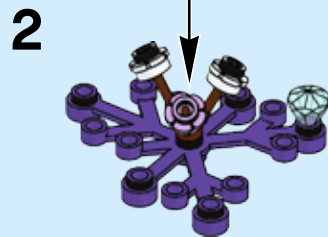
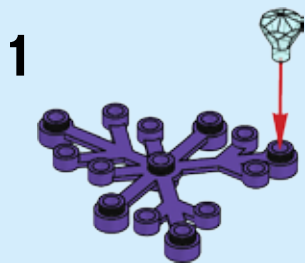

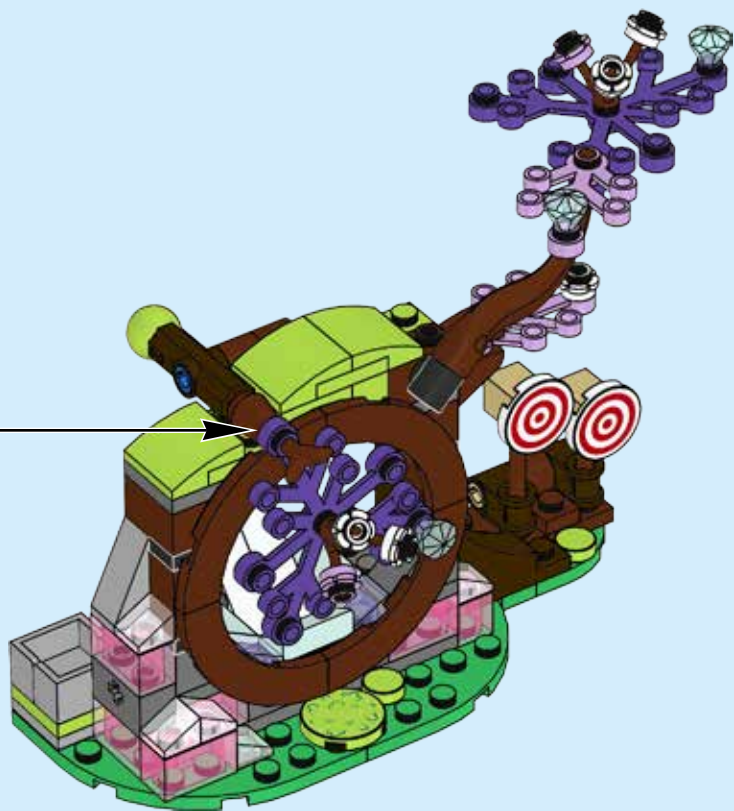

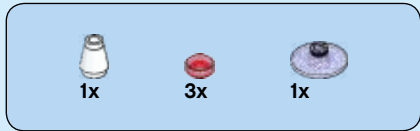

42

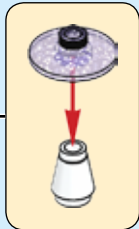
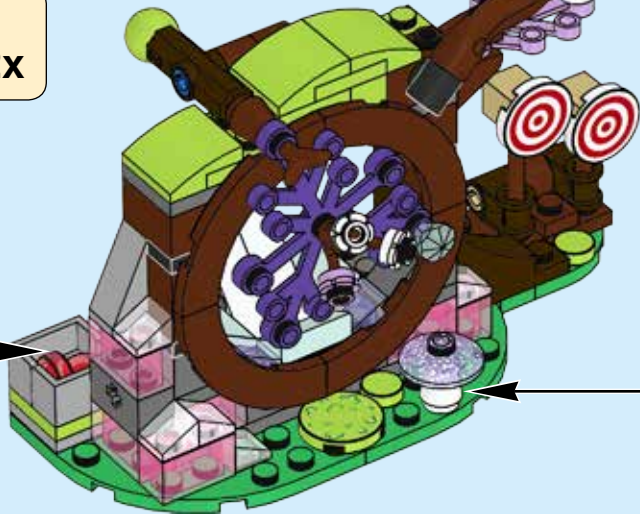

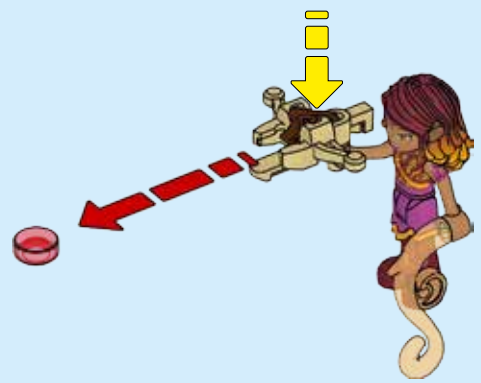
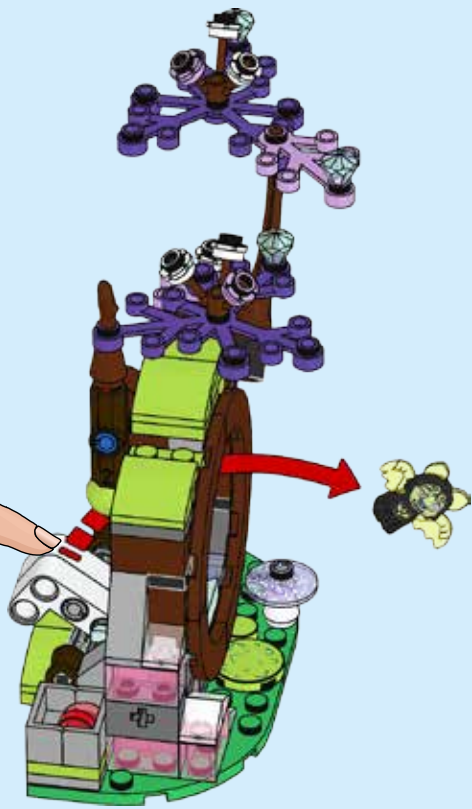

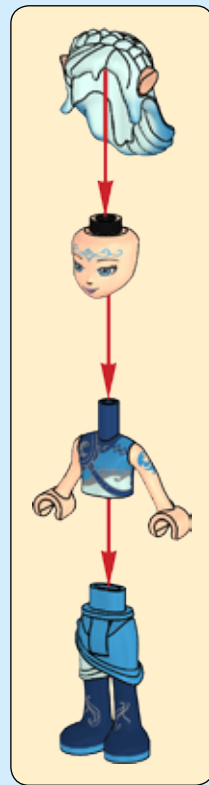
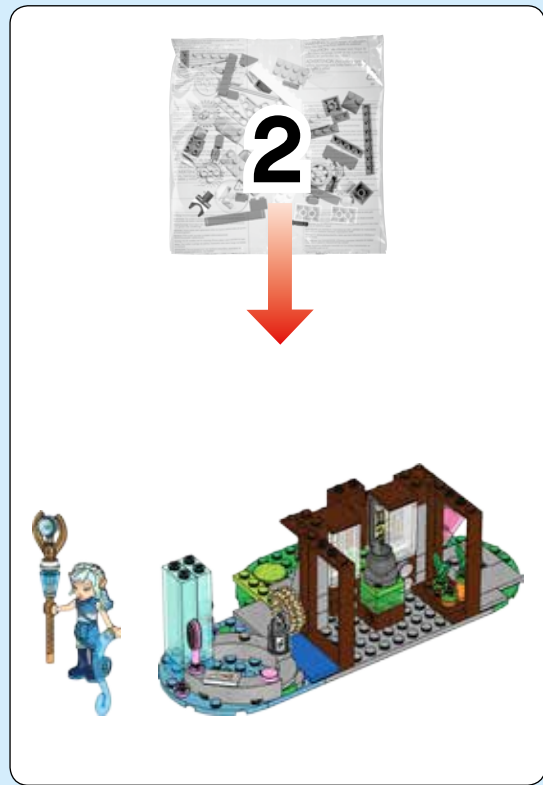



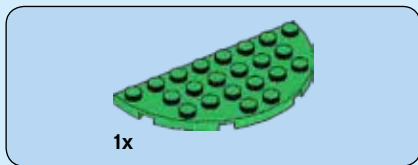

1

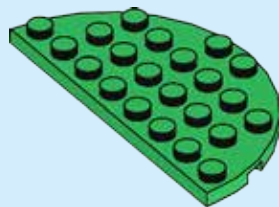

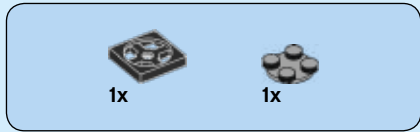

2

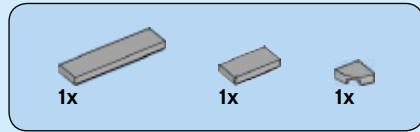
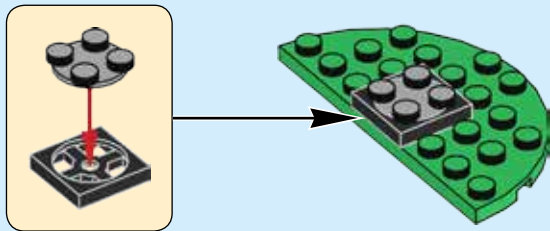

3

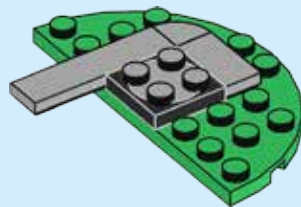

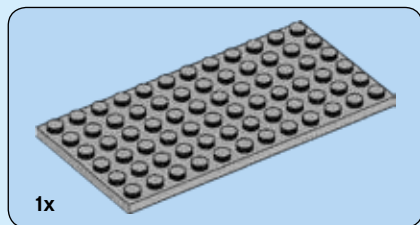

4

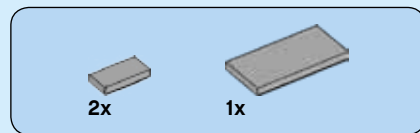
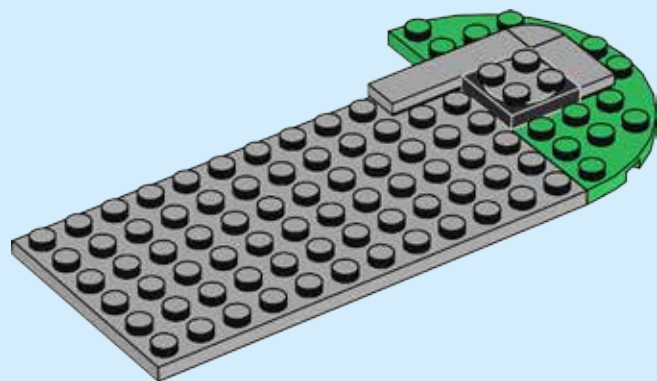

5

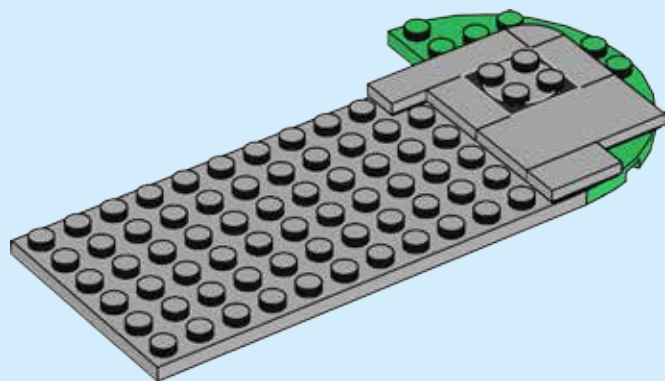

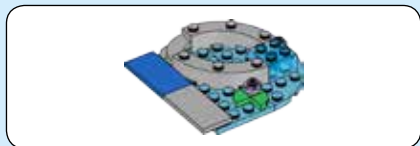

6

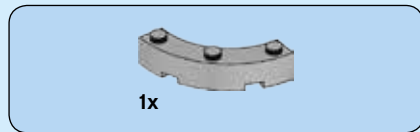

7

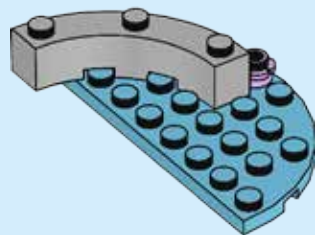

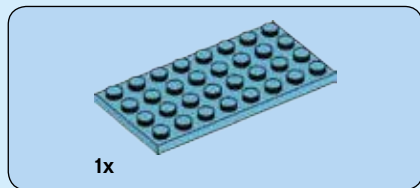

8

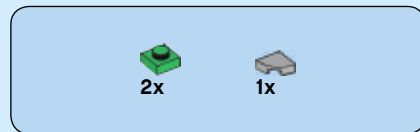
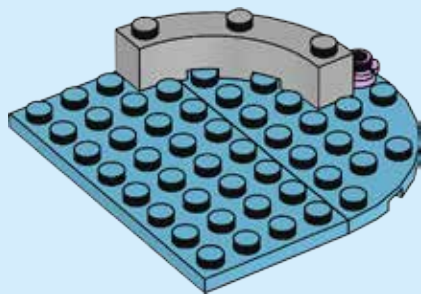

9

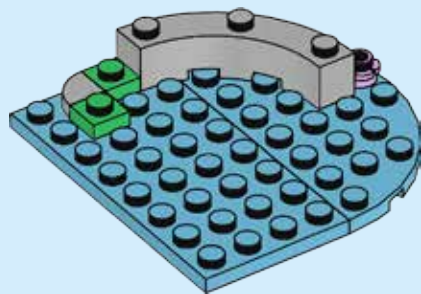



10

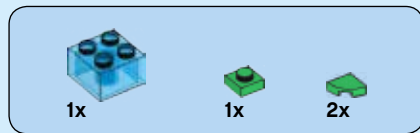
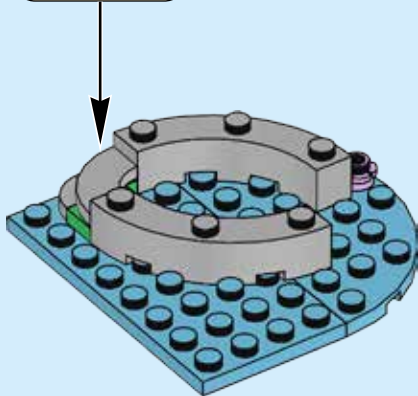

11

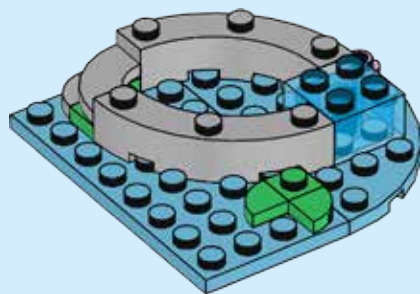



12

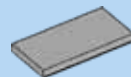
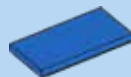
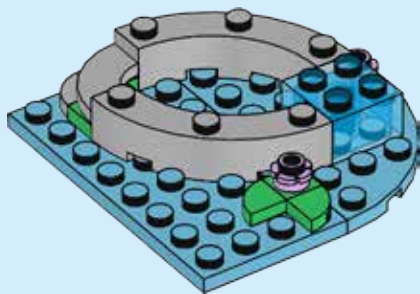

13

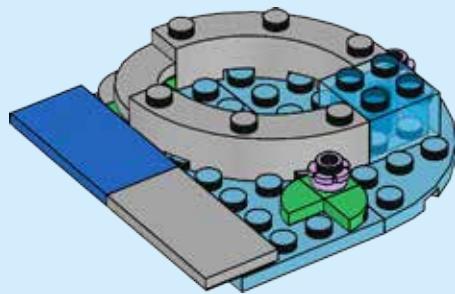

14

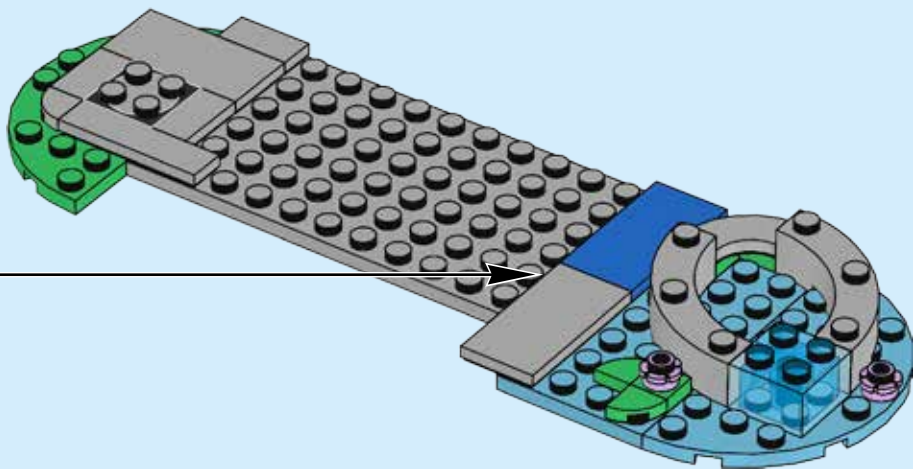
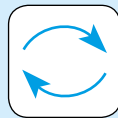



2x

15

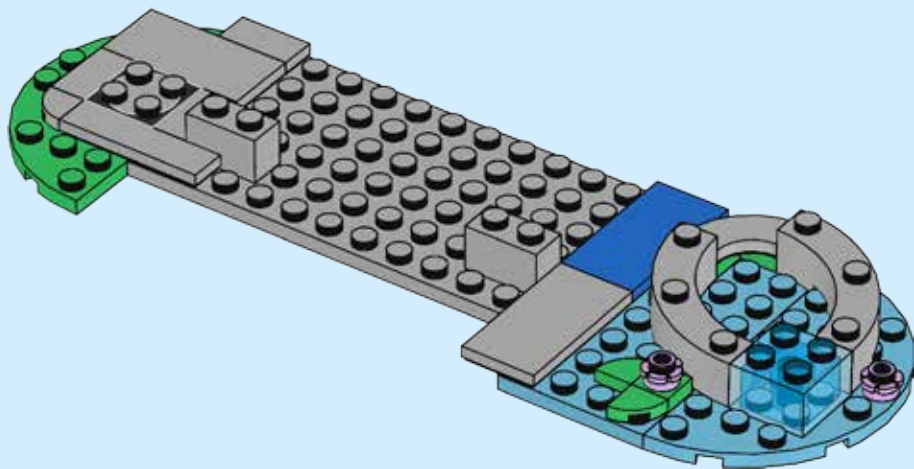

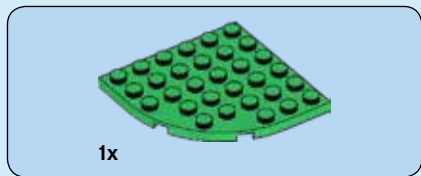

16

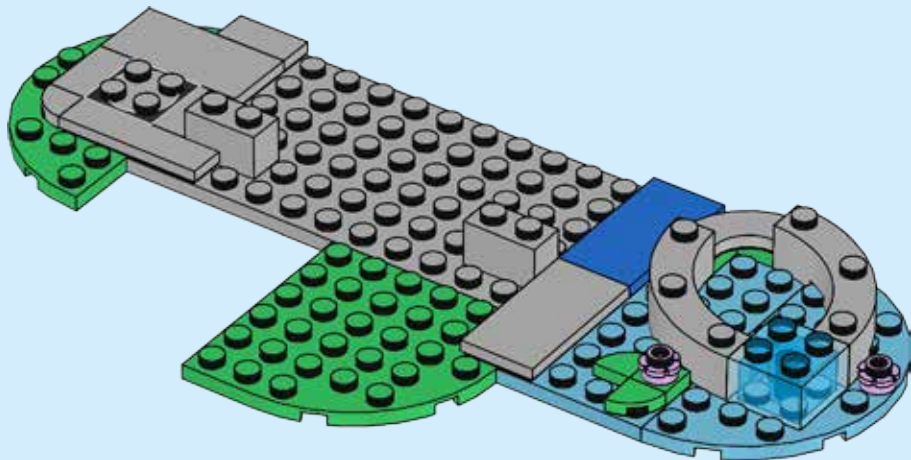



1x



1x

17

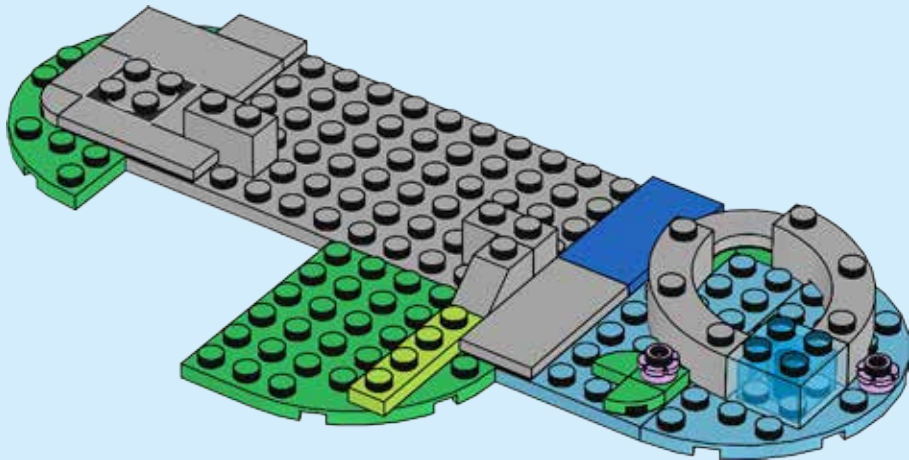



18

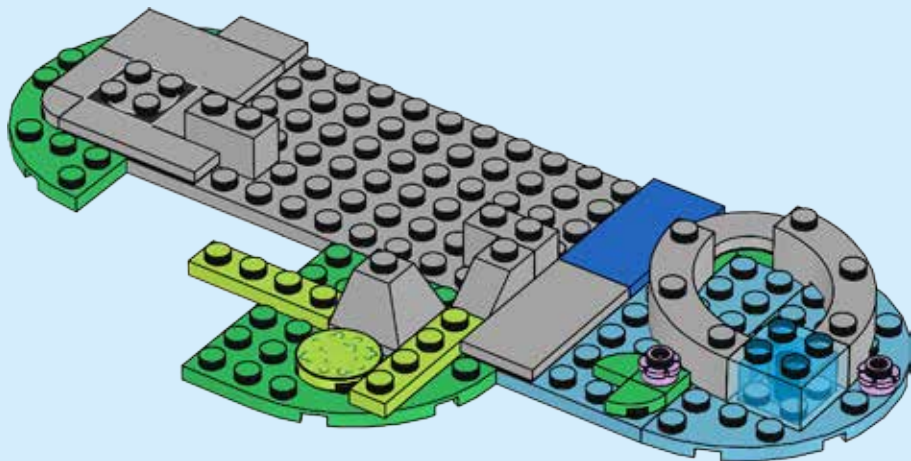



19

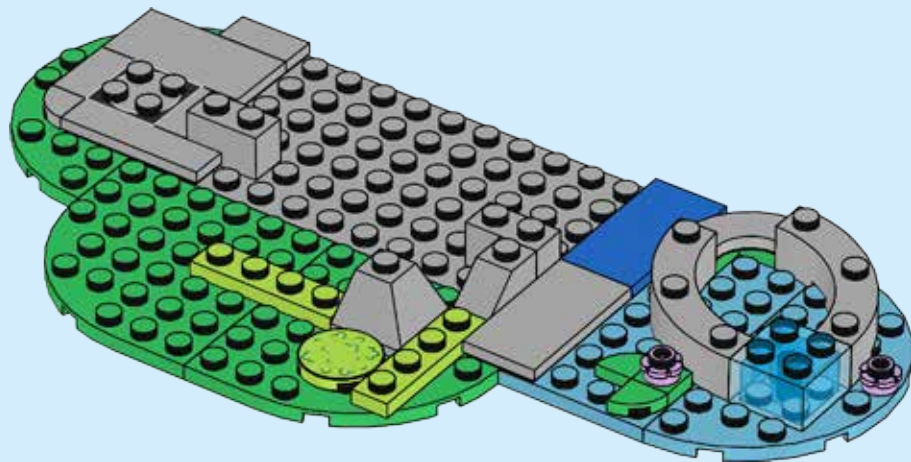



2x



2x

20

1

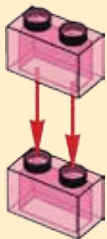

2

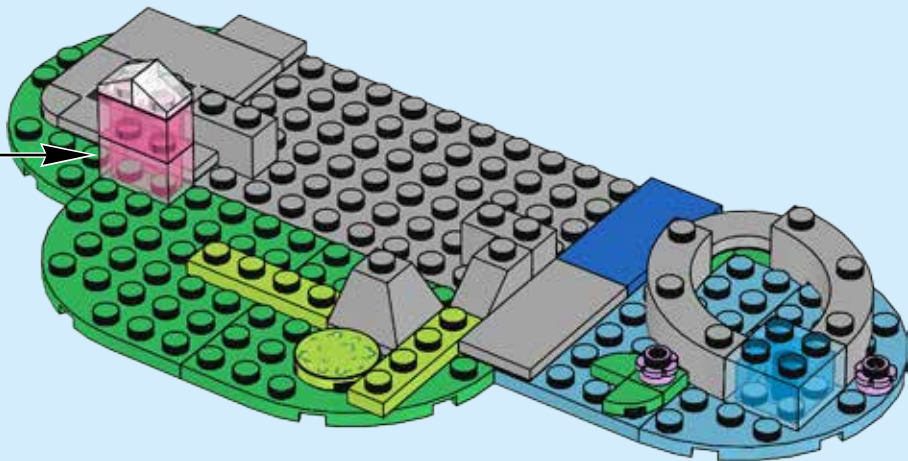

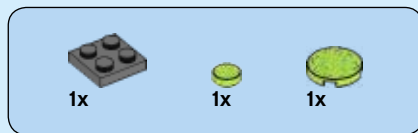

21

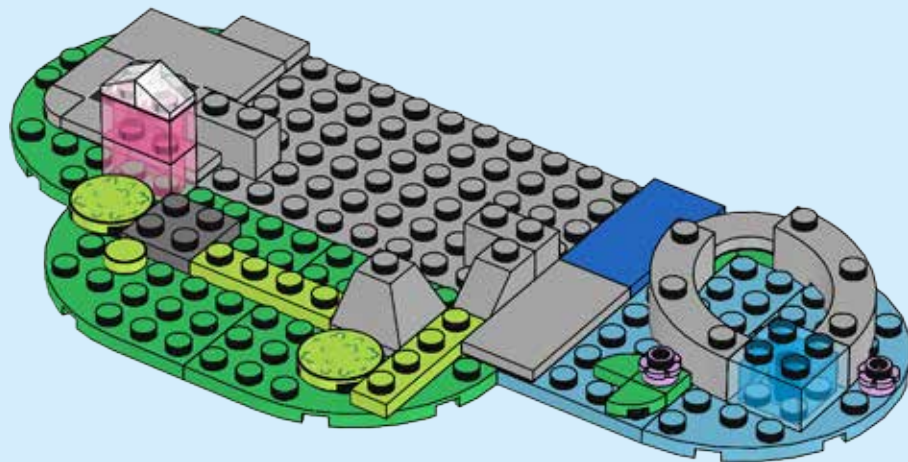

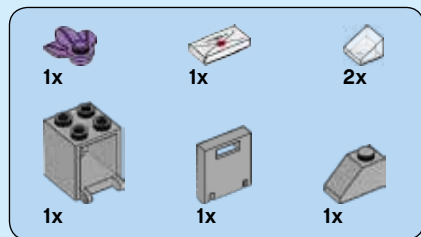

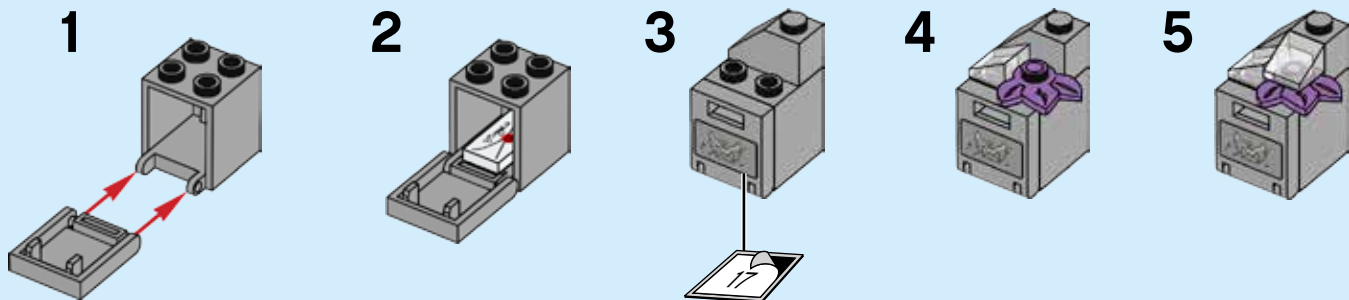

22

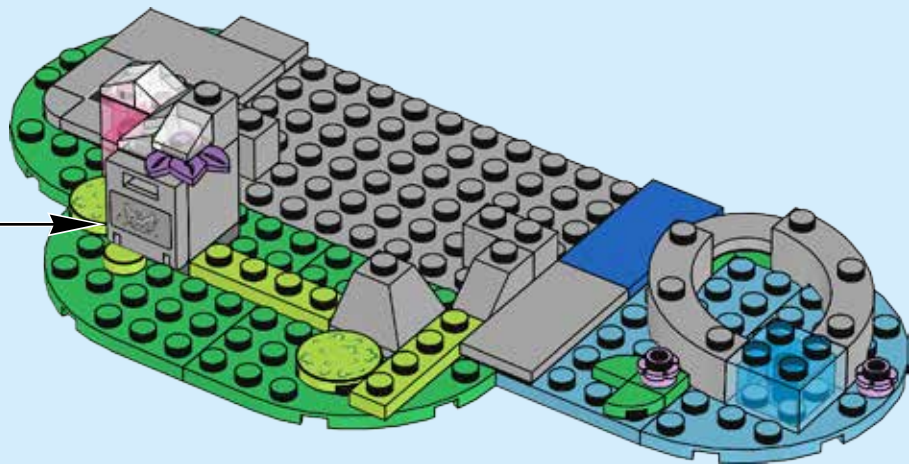



- 1x 
- 2x 
- 1x 

23

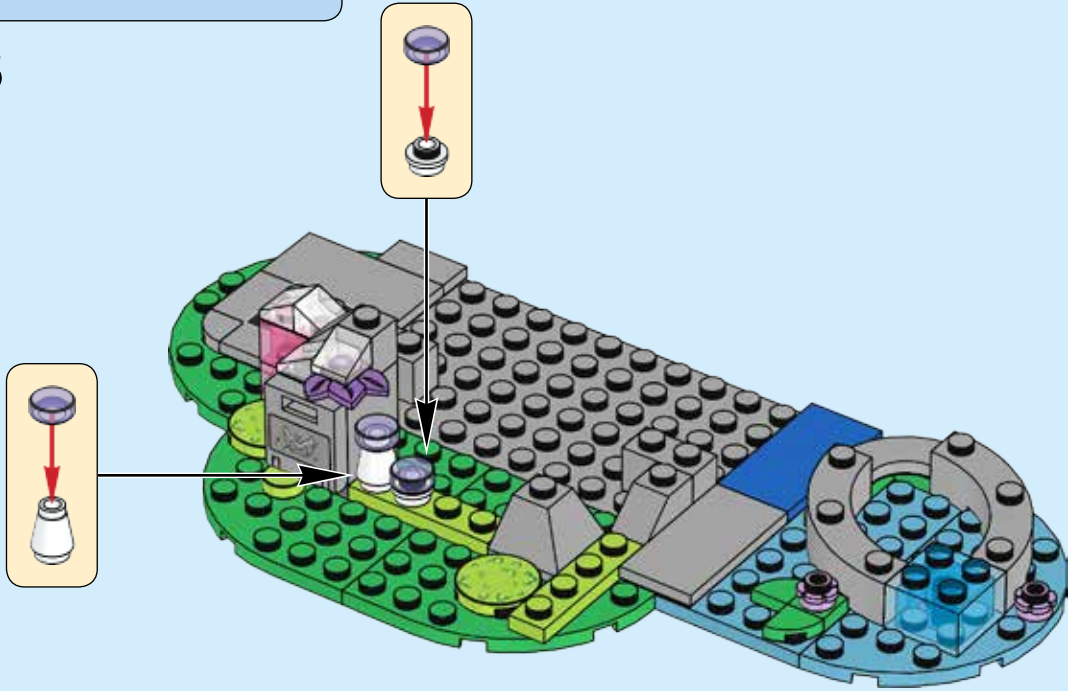

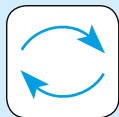
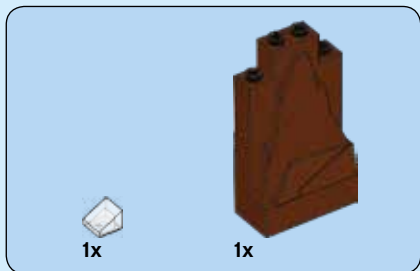

24

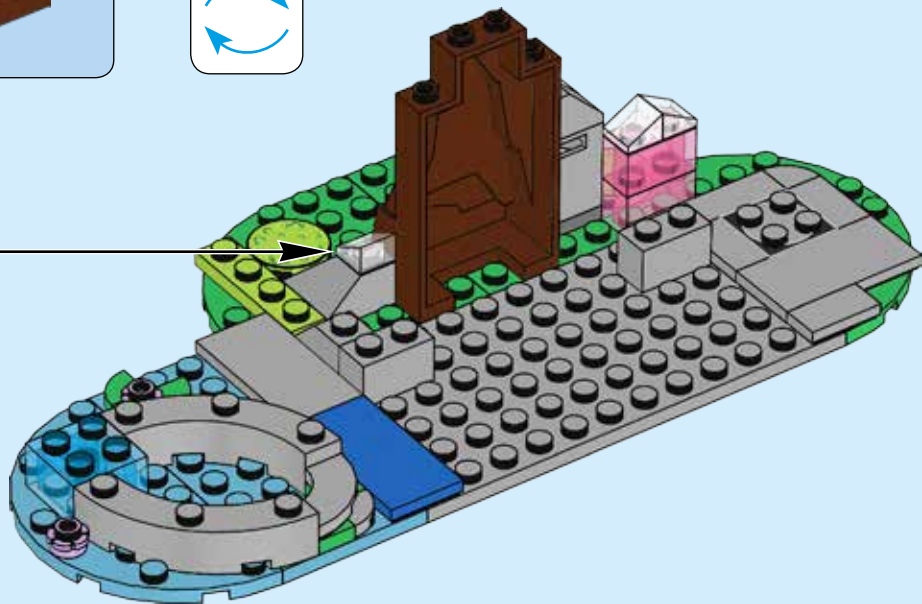

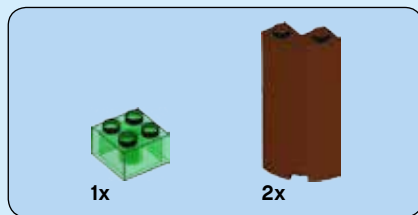

26



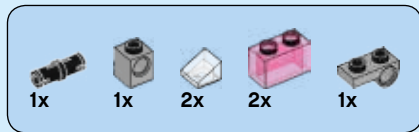

27

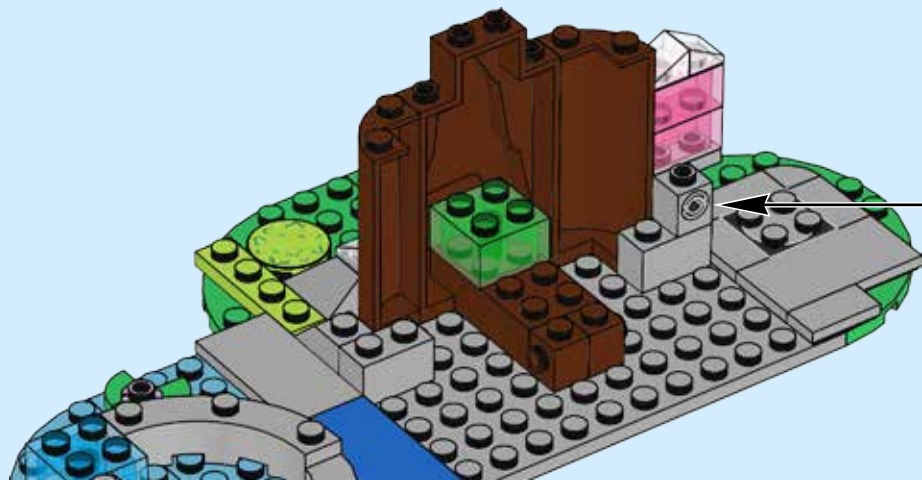
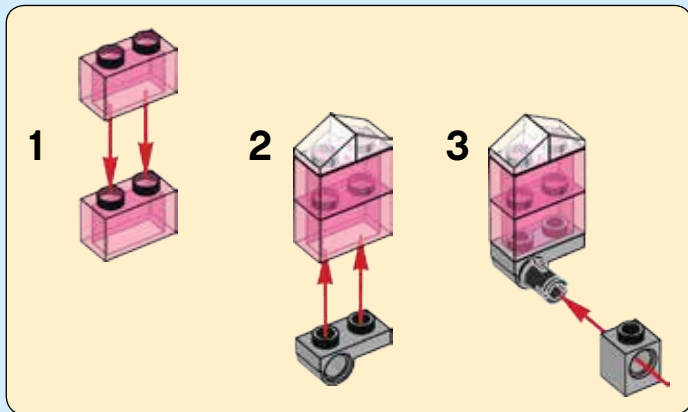

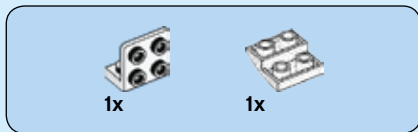
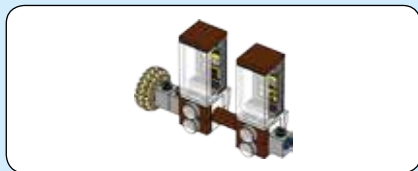

28

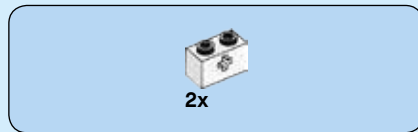
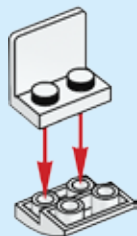

29

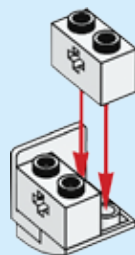



2x

30



2x

31



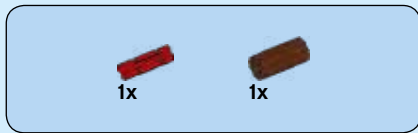

32

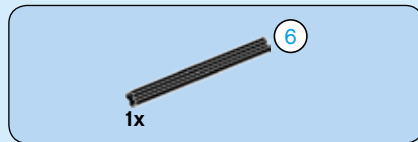
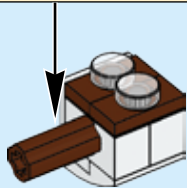
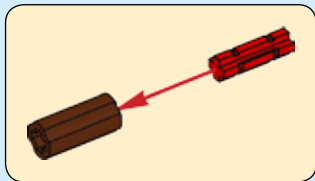

33

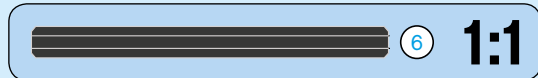
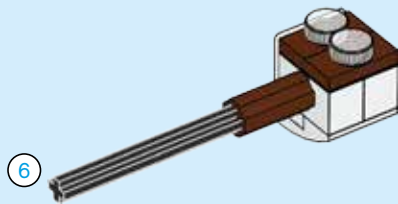

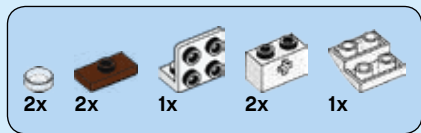

34

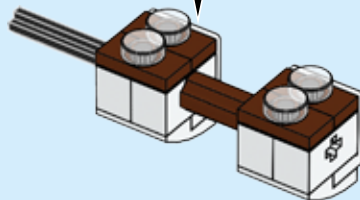
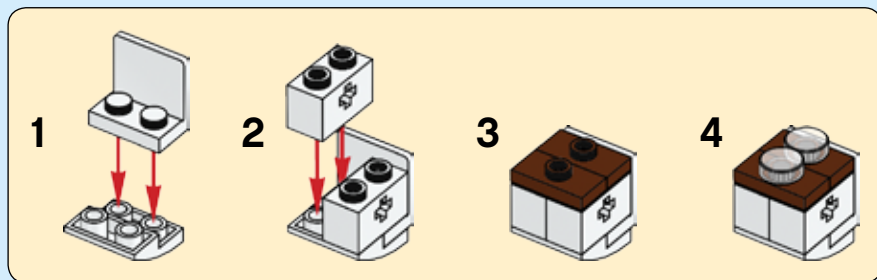

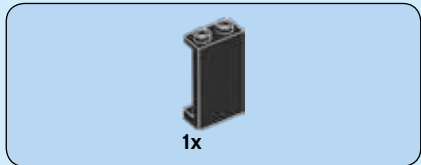

35

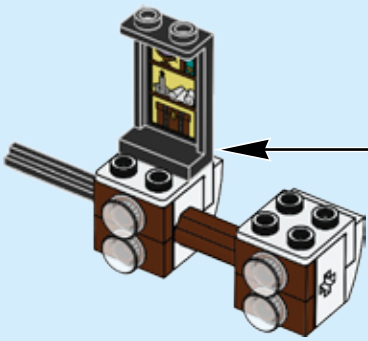
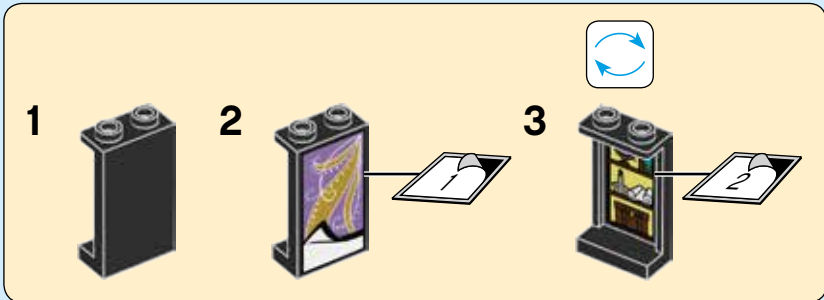
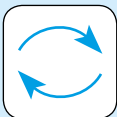

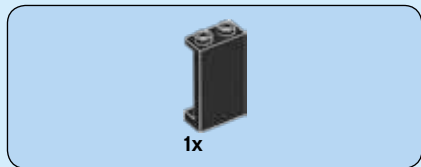

36

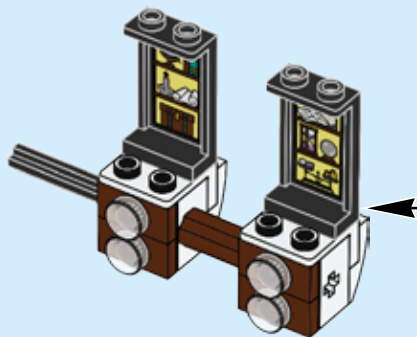
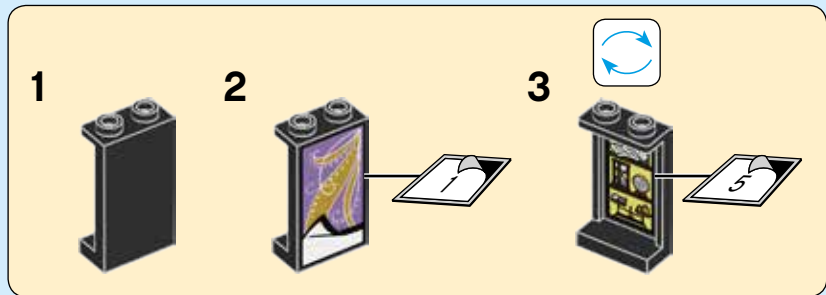



2x

37

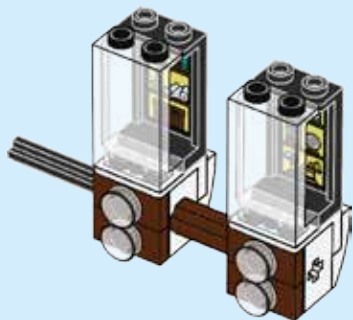

2x

38

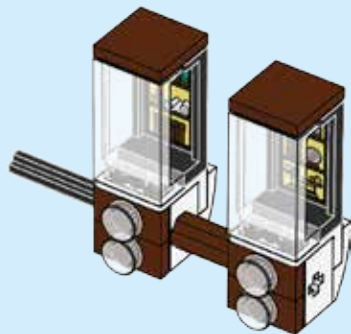



1x



1x

39

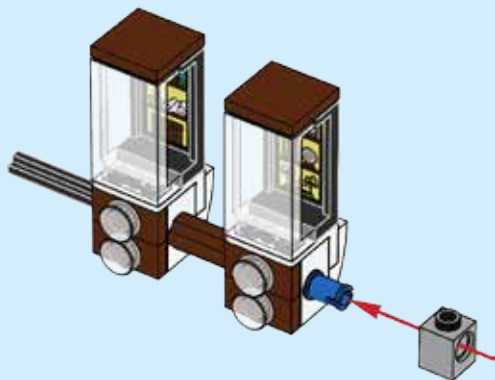

2x



1x

40

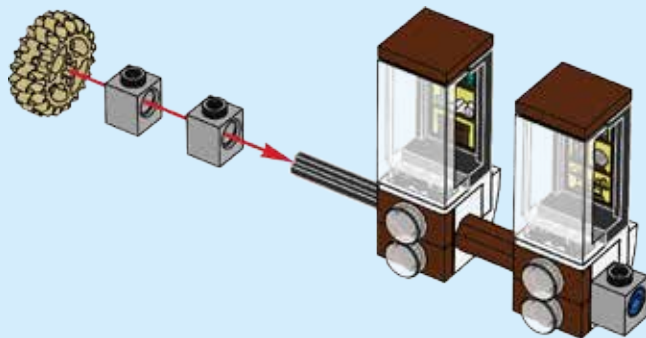

41





1x

42



43

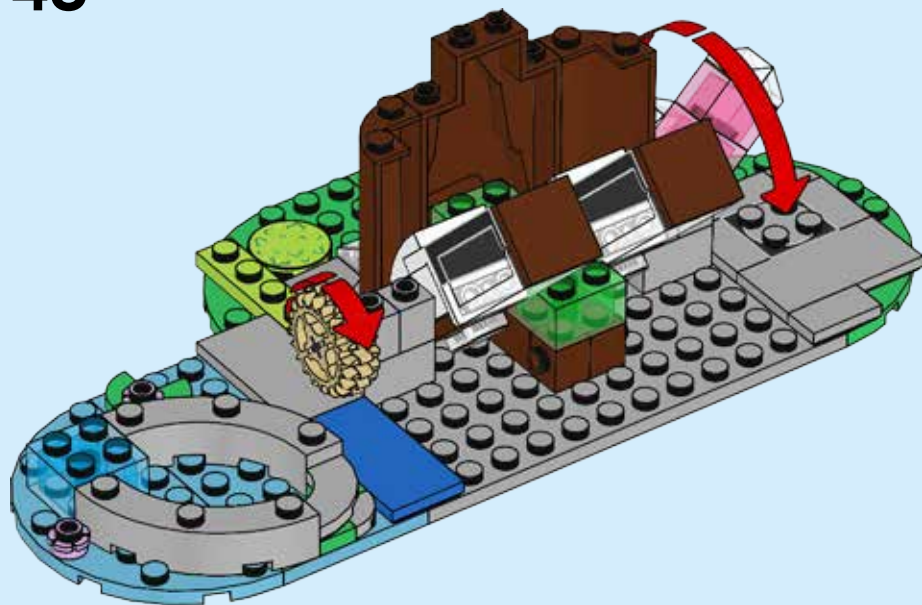

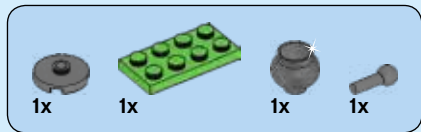

44

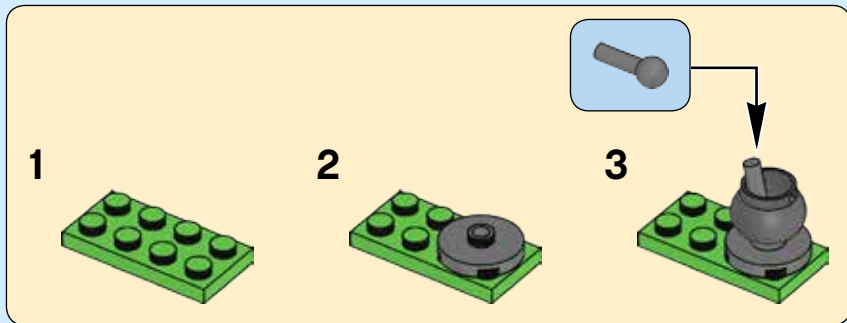



2x

45

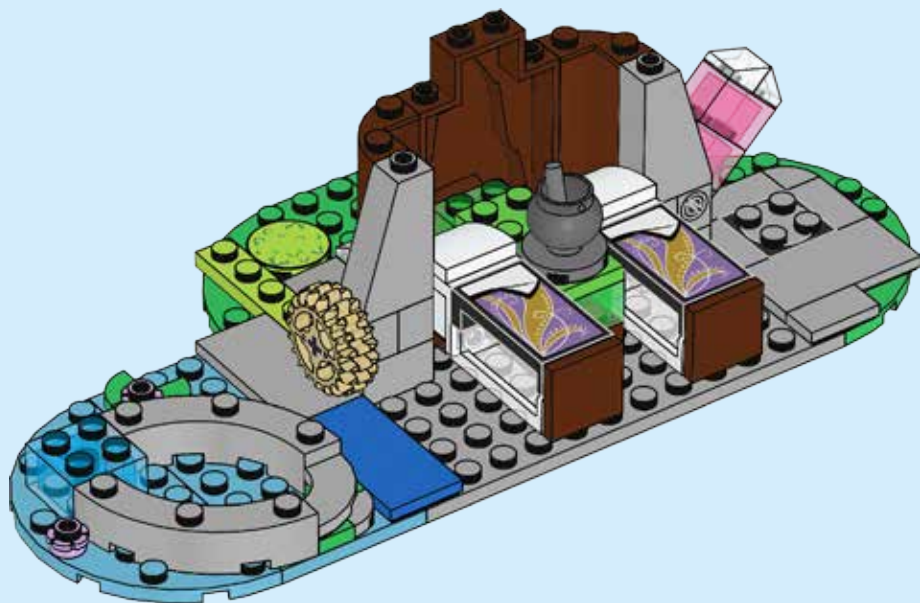



2x

46

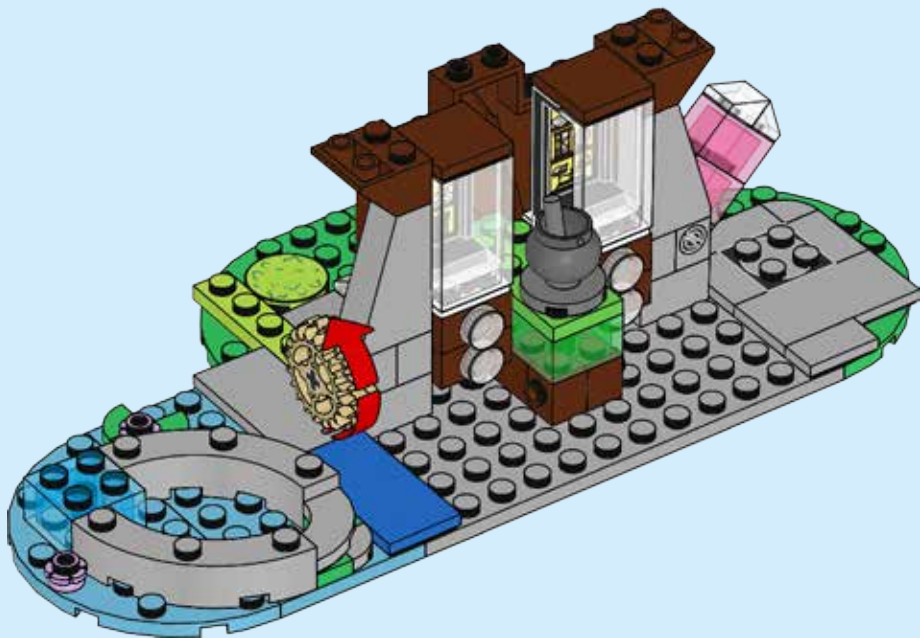

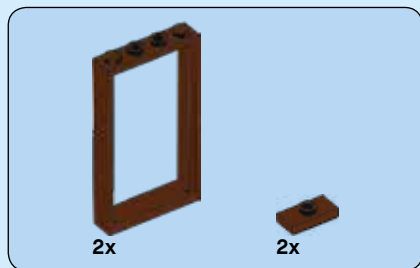

47





48

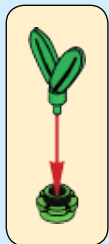

1



2



3



4



5







1x



1x



1x

49

1



2





50



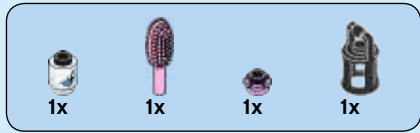

51

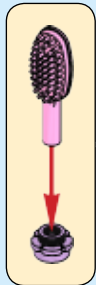
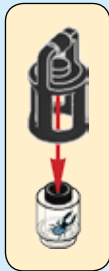



1x



1x

52

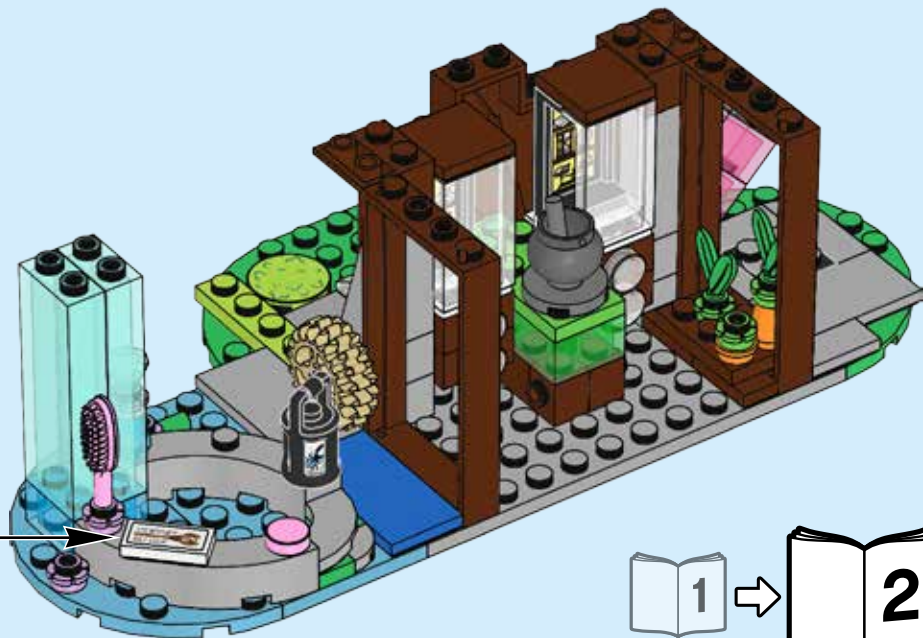

1



2

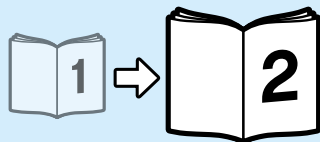



WIN

GO TO WWW.LEGO.COM/PRODUCTFEEDBACK AND
GIVE US YOUR SHORT **FEEDBACK** ABOUT THIS
LEGO® SET FOR A CHANCE TO WIN
A COOL LEGO PRIZE.

Terms & Conditions apply

LEGO.com/productfeedback

GEWINNE

Erzähle uns auf
www.LEGO.com/productfeedback

etwas über die Erfahrungen, die du mit
diesem LEGO® Set gemacht hast, und
sichere dir die Chance auf einen coolen
LEGO Preis!

Es gelten die Teilnahmebedingungen

GAGNE

Rends-toi sur
www.LEGO.com/productfeedback

et donne-nous quelques commentaires sur
ce produit LEGO® pour avoir une chance
de gagner un prix LEGO !

Voir Conditions Générales

GANAN

Visita
www.LEGO.com/productfeedback

y envíanos tu opinión acerca de este set
LEGO®. ¡Participarás en el sorteo de un
premio LEGO!

Términos y Condiciones aplicables

获取奖品

登录
www.LEGO.com/productfeedback

给出关于此乐高®套装的简短反馈，
就有机会获得炫酷乐高奖品

《条款及条件》适用

LEGO and the LEGO logo are trademarks of the/son des marques de commerce du/son marcas registradas de LEGO Group. ©2018 The LEGO Group.

6241694