



Disney



43232





### **Get excited about our new packaging!**

We're switching from plastic to paper-based packaging. That's why you might find a mix of paper and plastic in our boxes!

### **Nos nouveaux emballages vous emballeront !**

Nous passons des emballages en plastique aux emballages à base de papier. C'est pourquoi vous pourriez trouver un mélange de papier et de plastique dans nos boîtes !

### **¡Te presentamos nuestros nuevos empaques!**

Estamos sustituyendo las bolsas de plástico por bolsas con base de papel. ¡Por eso, puedes encontrar una mezcla de papel y de plástico en nuestras cajas!

**[LEGO.com/sustainable-packaging](https://www.lego.com/sustainable-packaging)**



# BUILDER



Apple and the Apple logo are trademarks of Apple Inc., registered in the U.S. and other countries and regions. App Store is a service mark of Apple Inc. Google Play and the Google Play logo are trademarks of Google LLC. Tencent and the Tencent logo are trademarks of Tencent Inc.

[LEGO.com/devicecheck](https://www.lego.com/devicecheck)

EN Ask parents' permission before going online | DE Eltern um Erlaubnis bitten, bevor du online gehst | FR Demande l'autorisation d'un parent avant d'aller en ligne | IT Chiedi il permesso ai tuoi genitori prima di andare online | ES Pídeles permiso a tus papás antes de conectarte a Internet | PT Peça autorização aos pais antes de acederes online | ZH 上网前应先征得父母的同意 | PL Poproś rodziców o zgodę, zanim wejdiesz do Internetu | CS Než půjdeš na internet, požádej rodiče o svolení | SK Skôr než pôjdeš na internet, vypýtaj si povolenie od rodičov | HU Kérj szülői engedélyt, mielőtt online csatlakoznál! | RO Cere permisiunea părinților înainte de a te conecta online | BG Поискайте разрешение от родител, преди да влезете онлайн | LV Pirms došanās tiešsaistē palūdz atļauju vecākiem | ET Enne Interneti kasutamist küsi vanematelt luba | LT Prieš prisijungdami prie interneto, atsklauskite tėvų

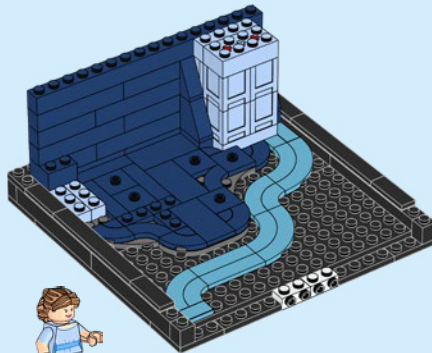
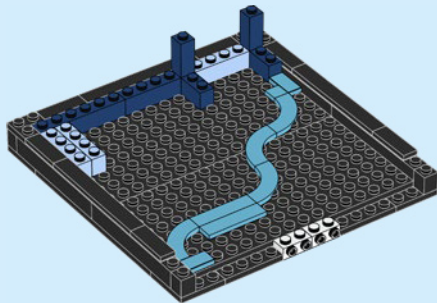
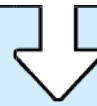
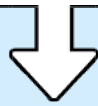
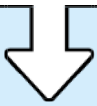

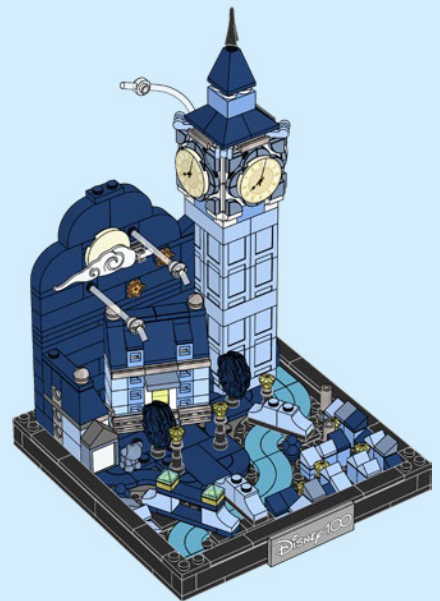
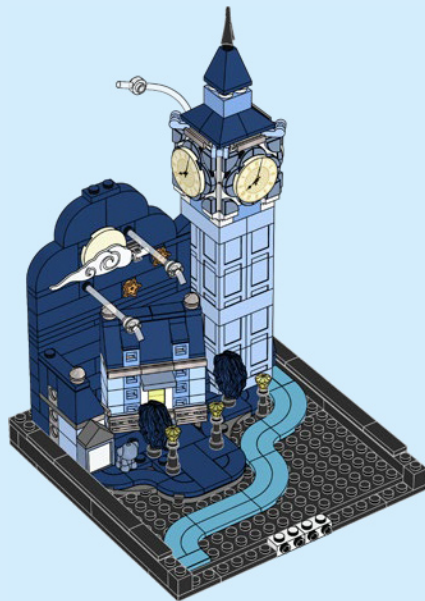
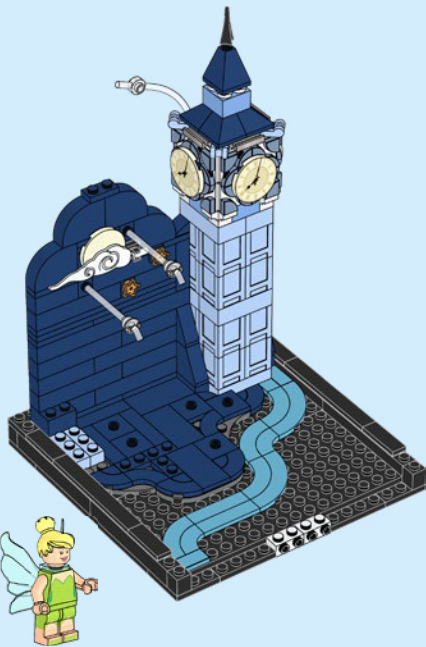

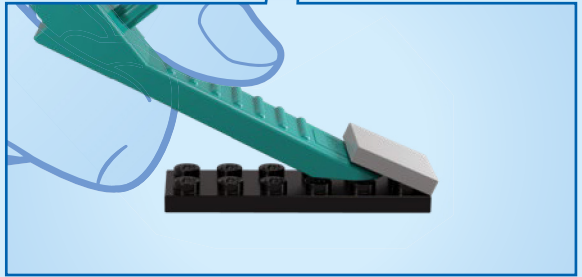
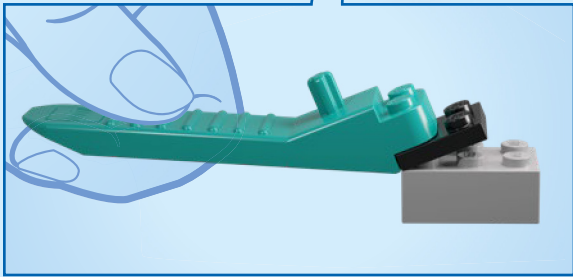
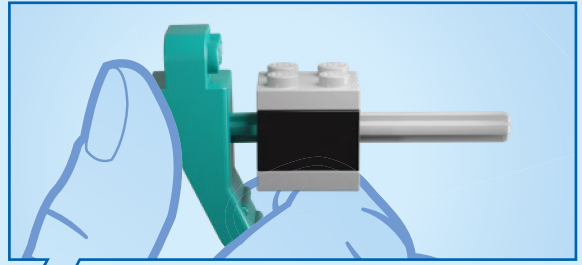
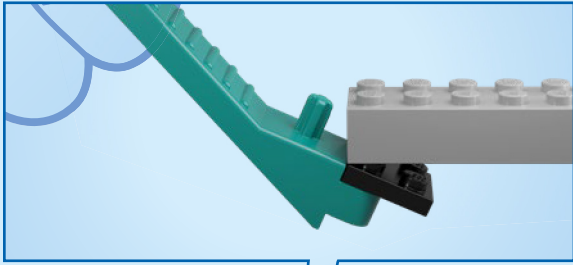

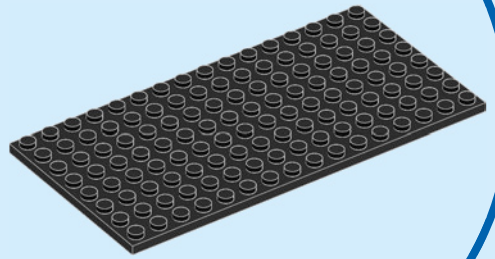
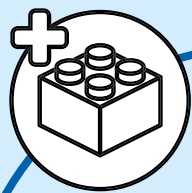
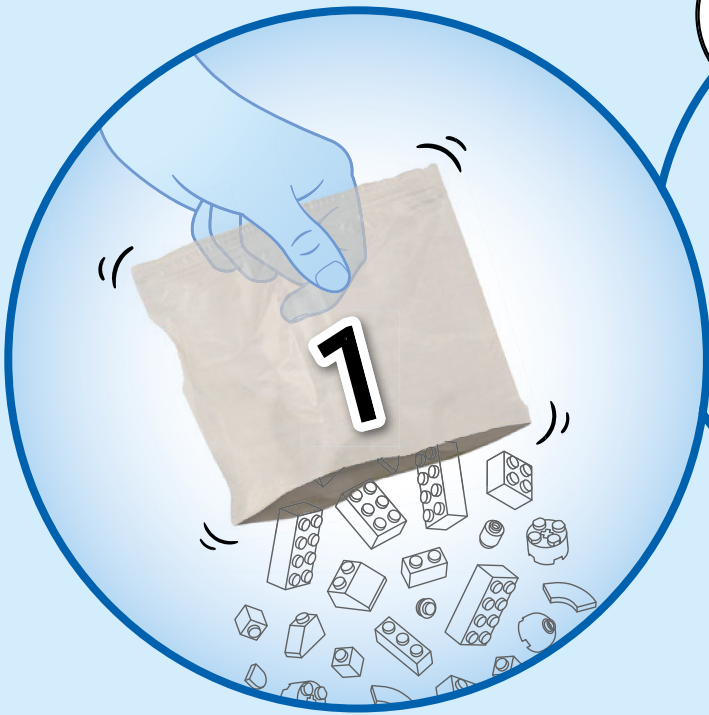

2x

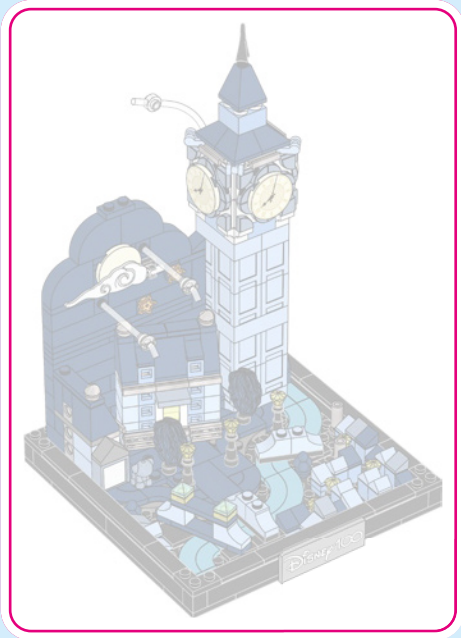

1

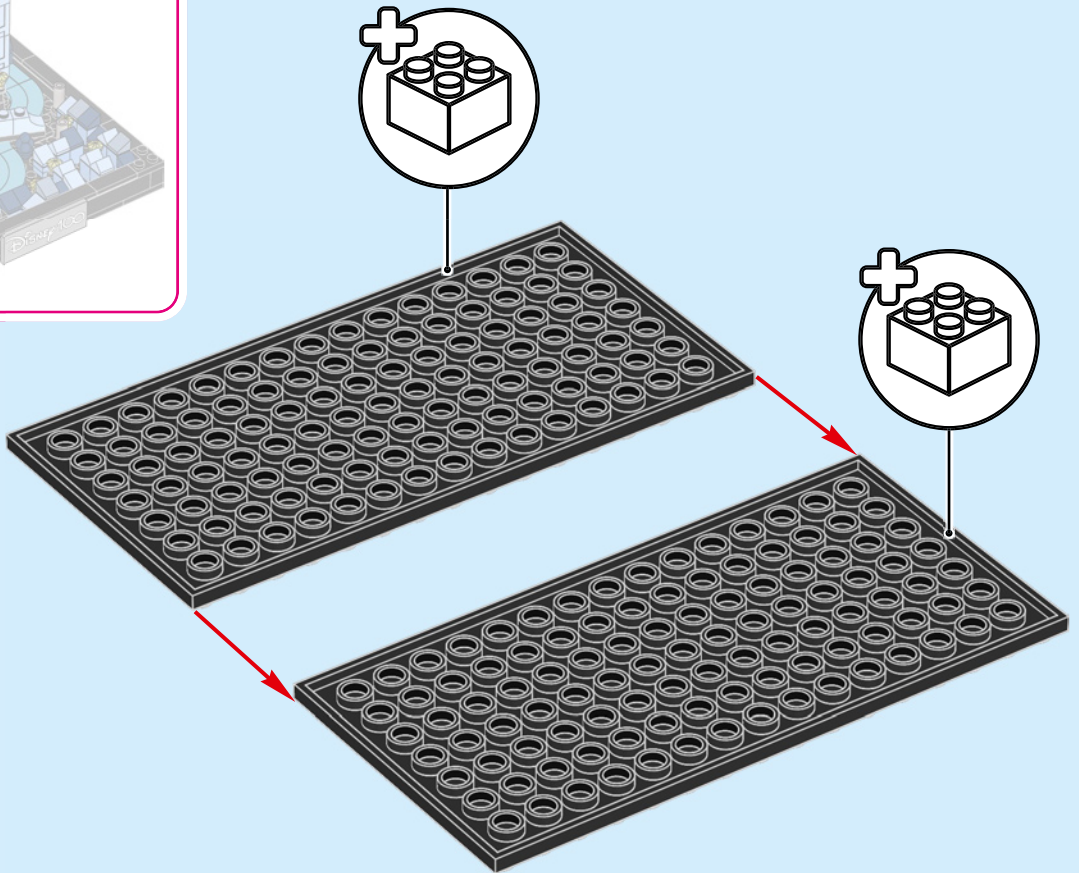



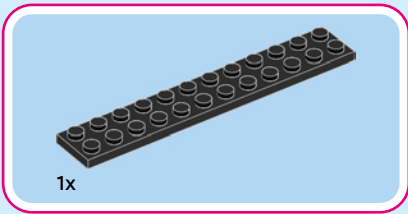

2

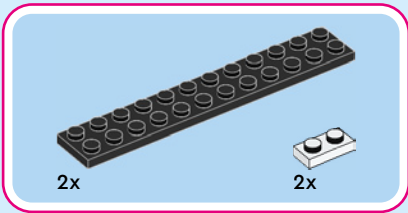
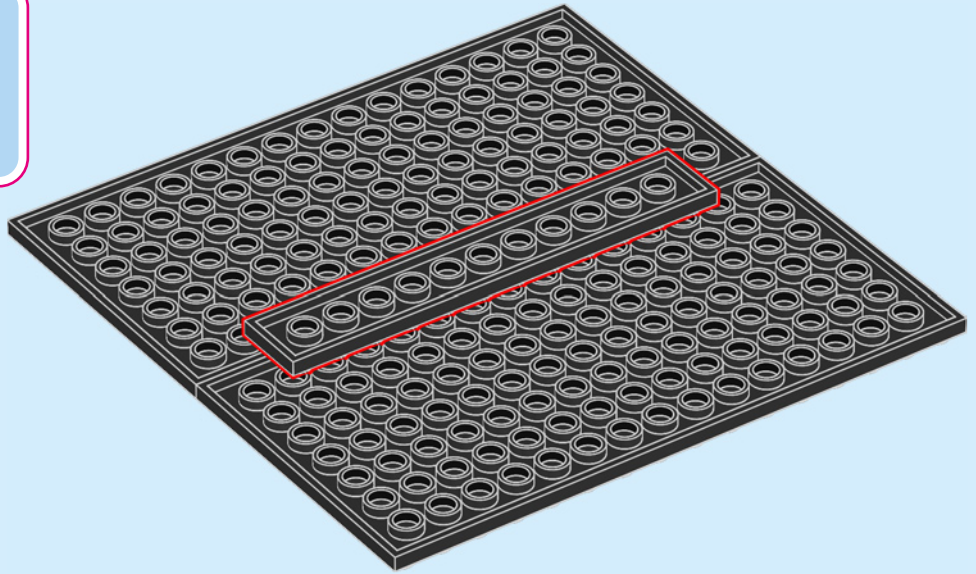

3

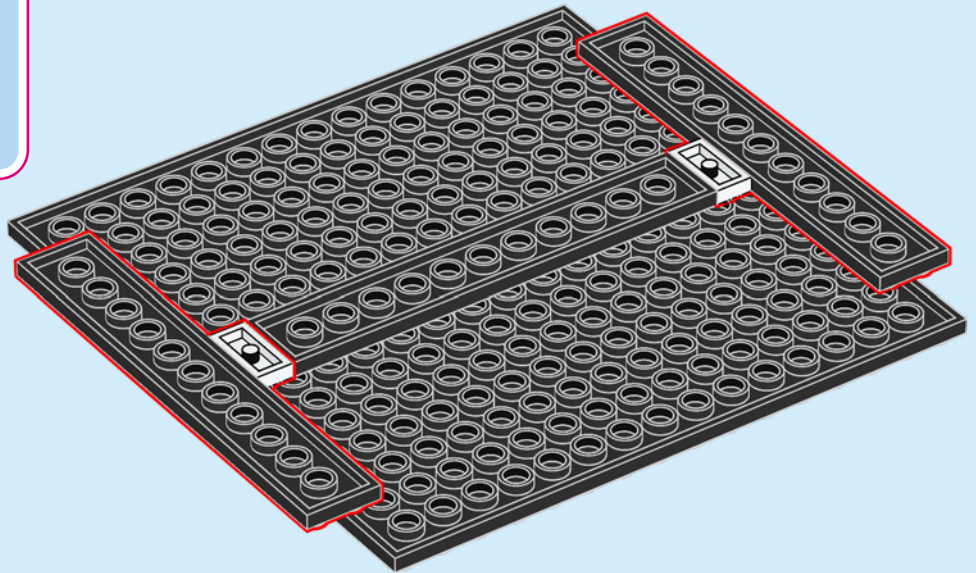

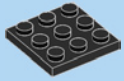

4x

4

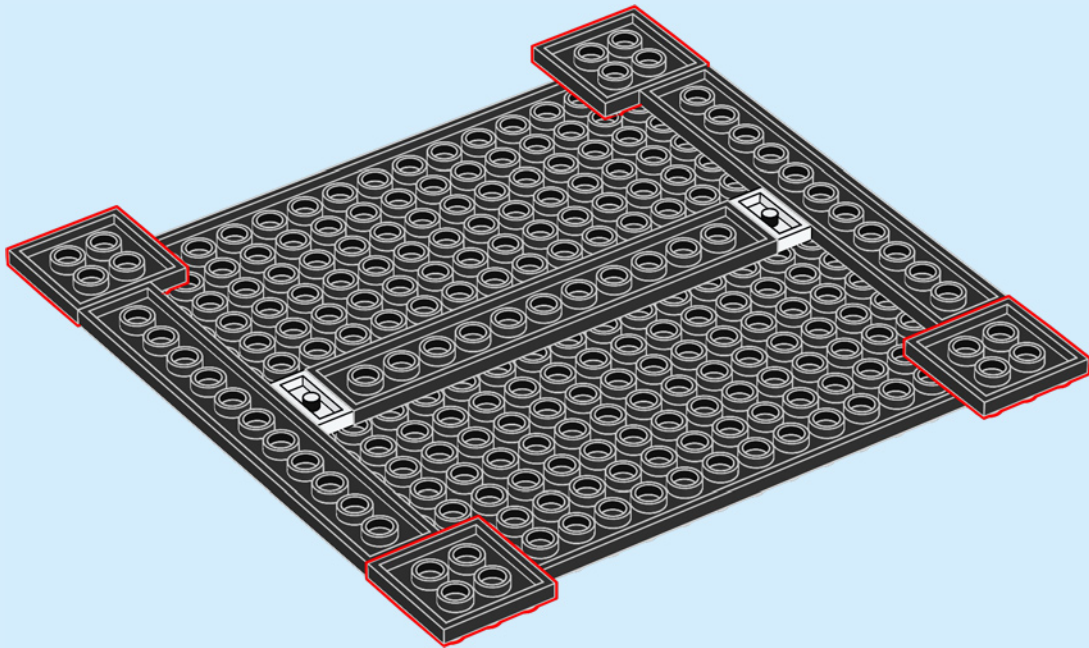

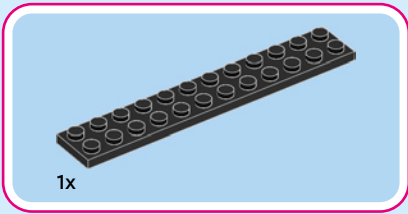

5

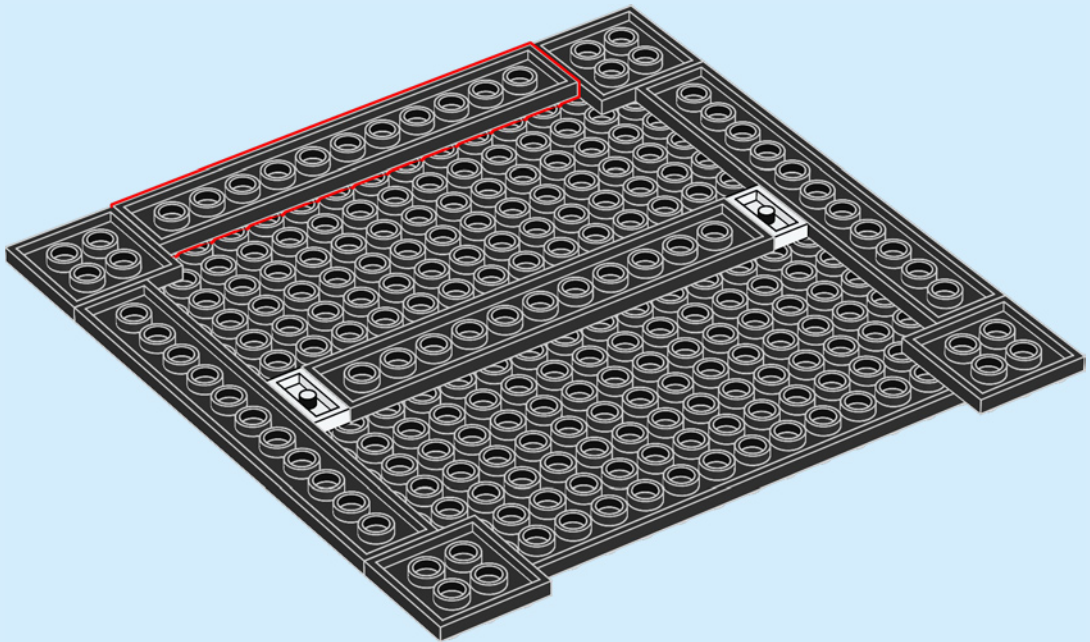

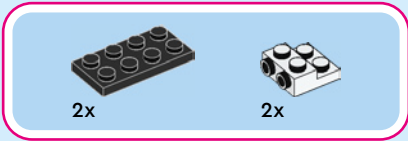

6

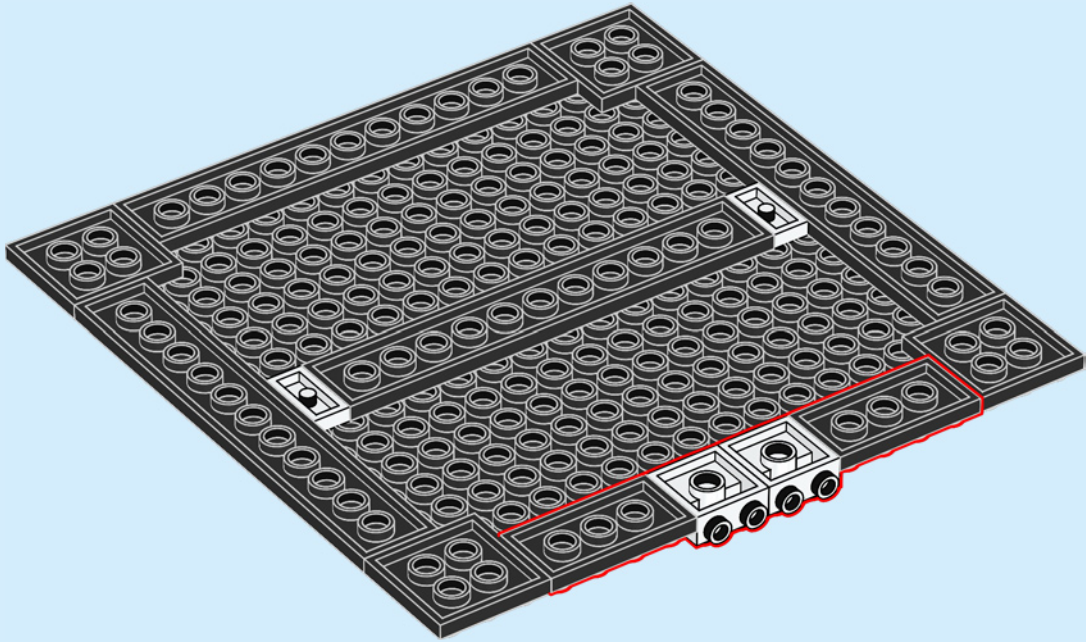

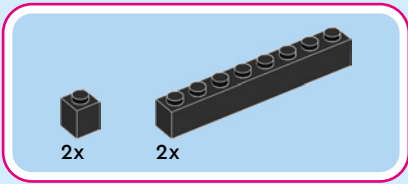

7

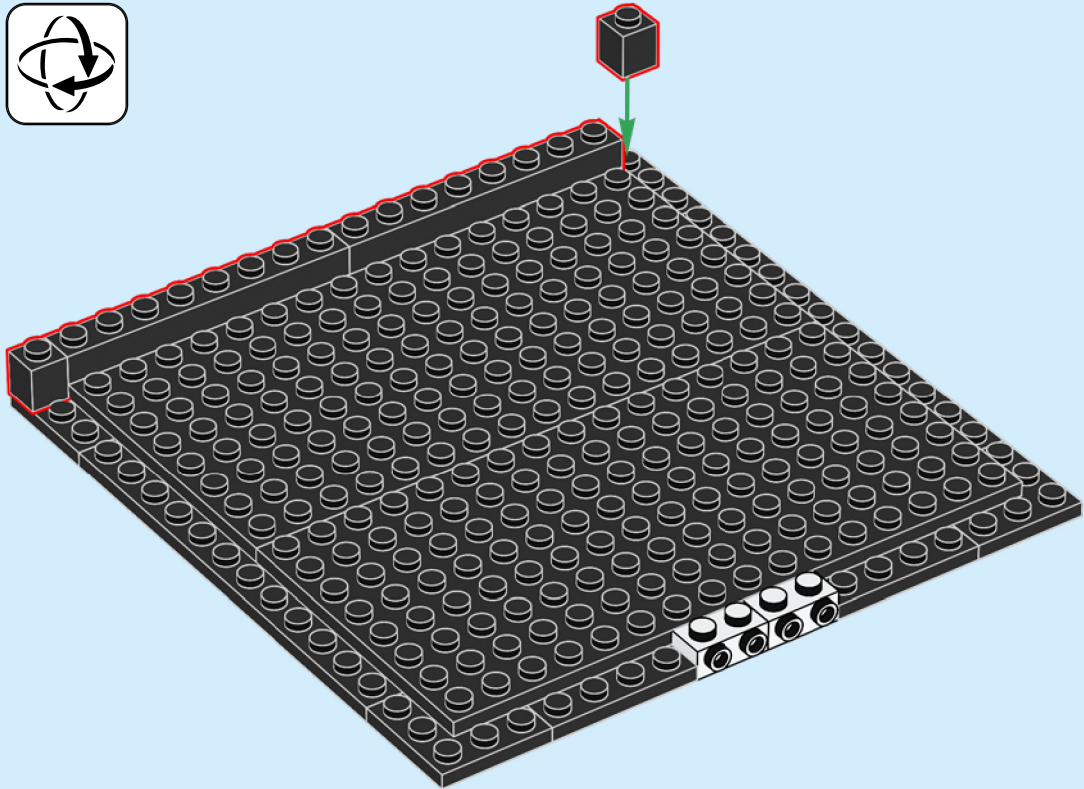



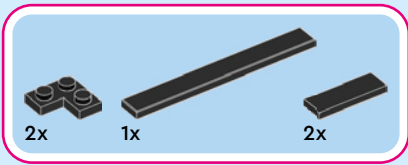

9

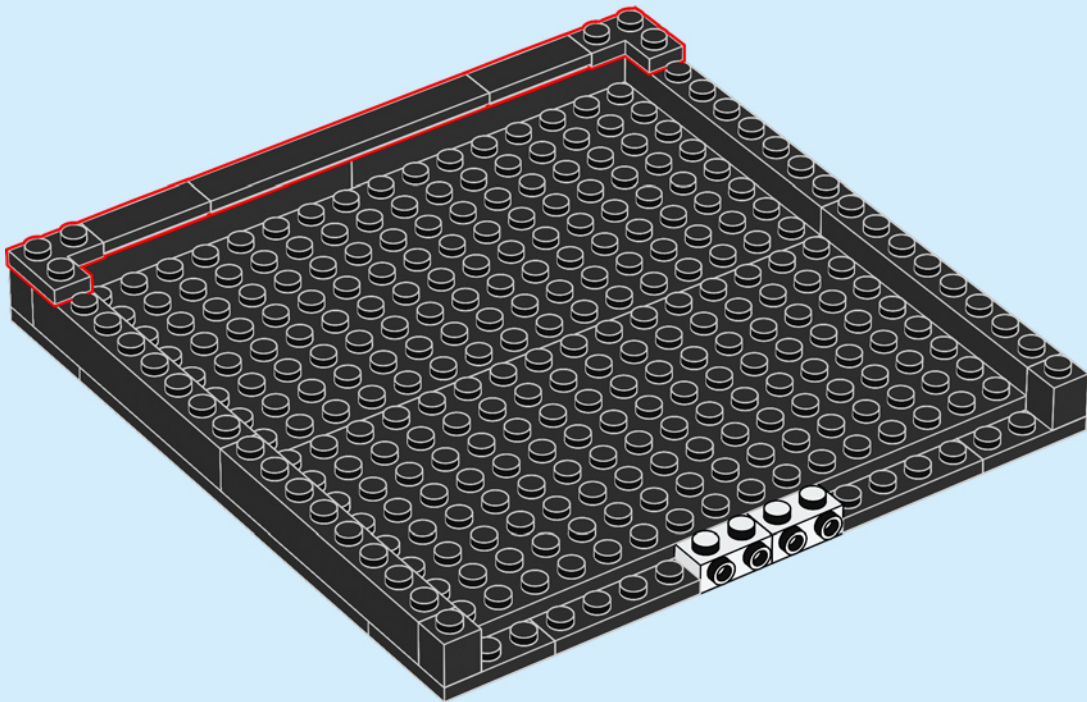

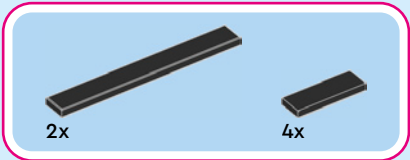

10

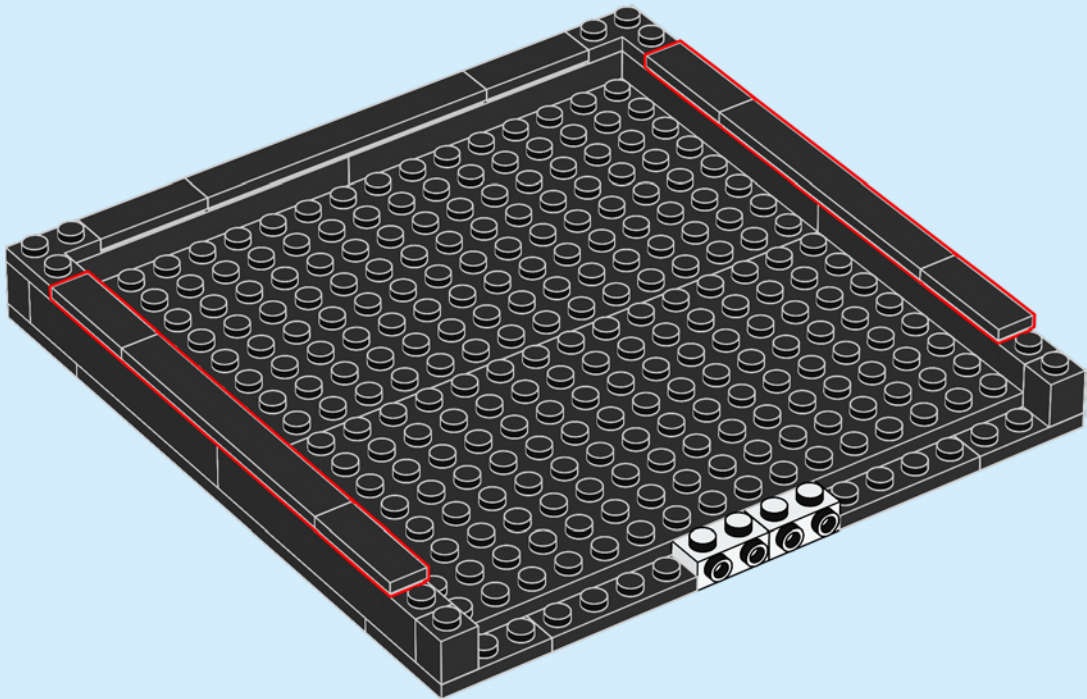



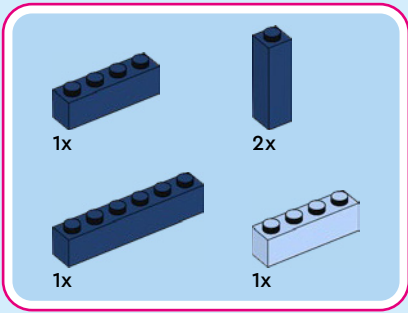

11

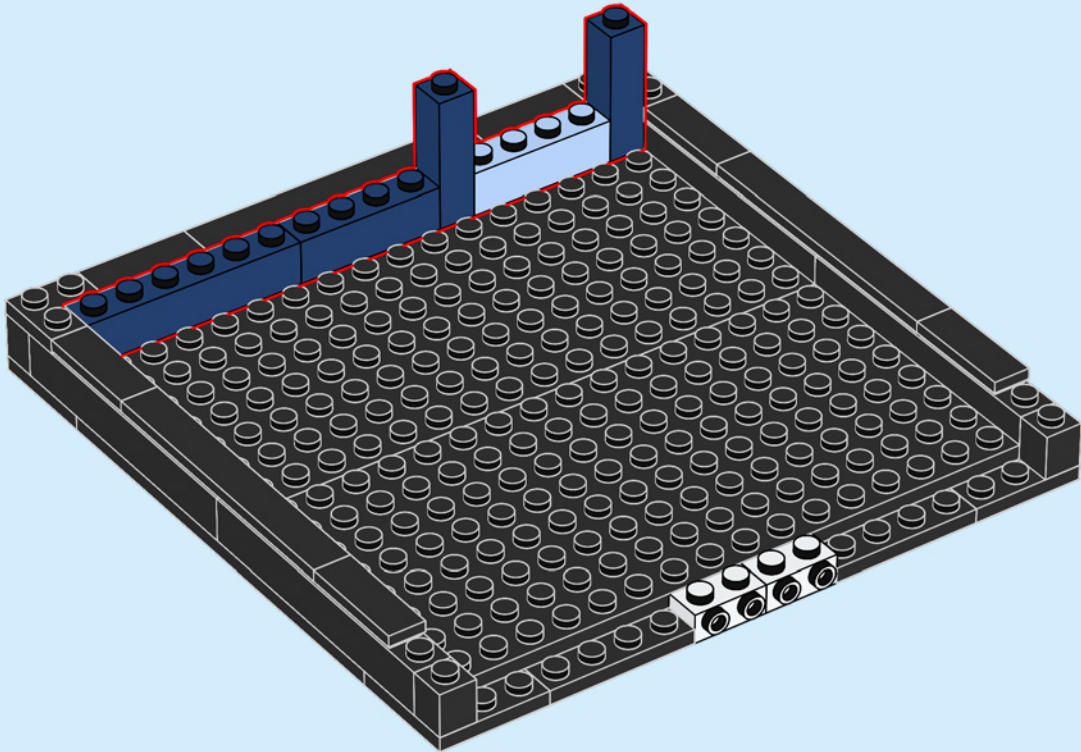



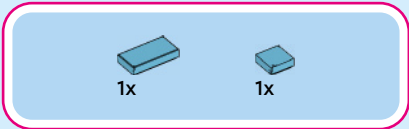

13

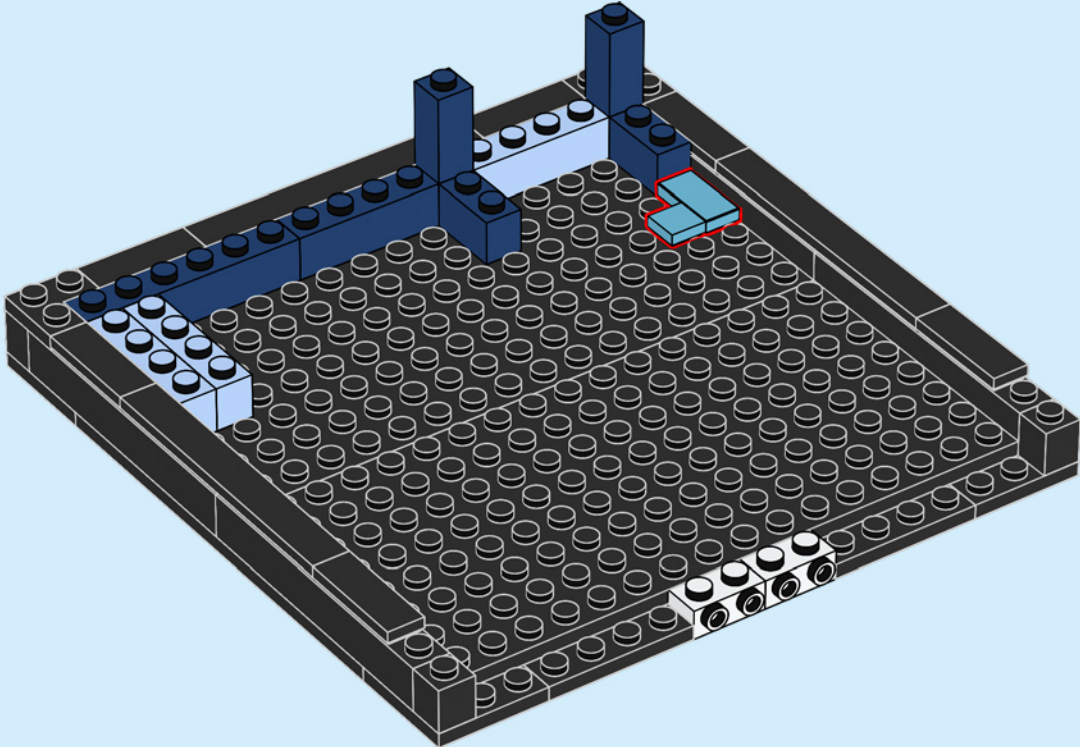



2x

14

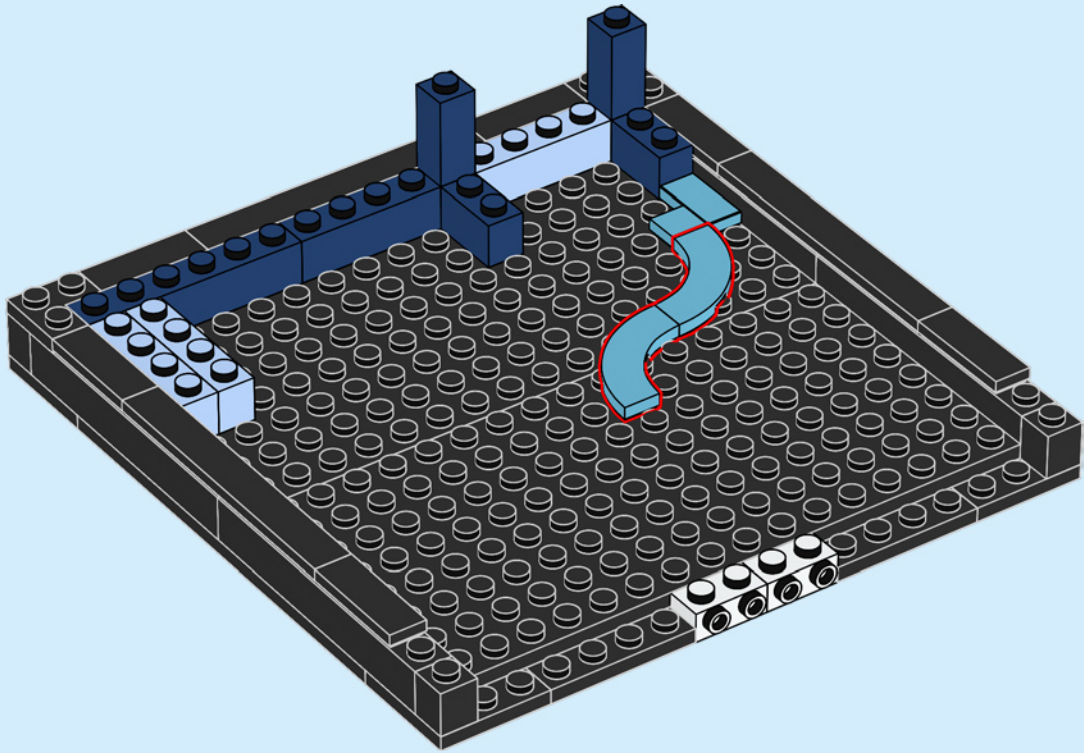

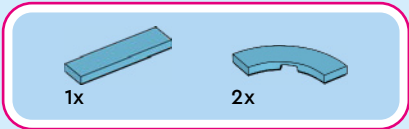

15

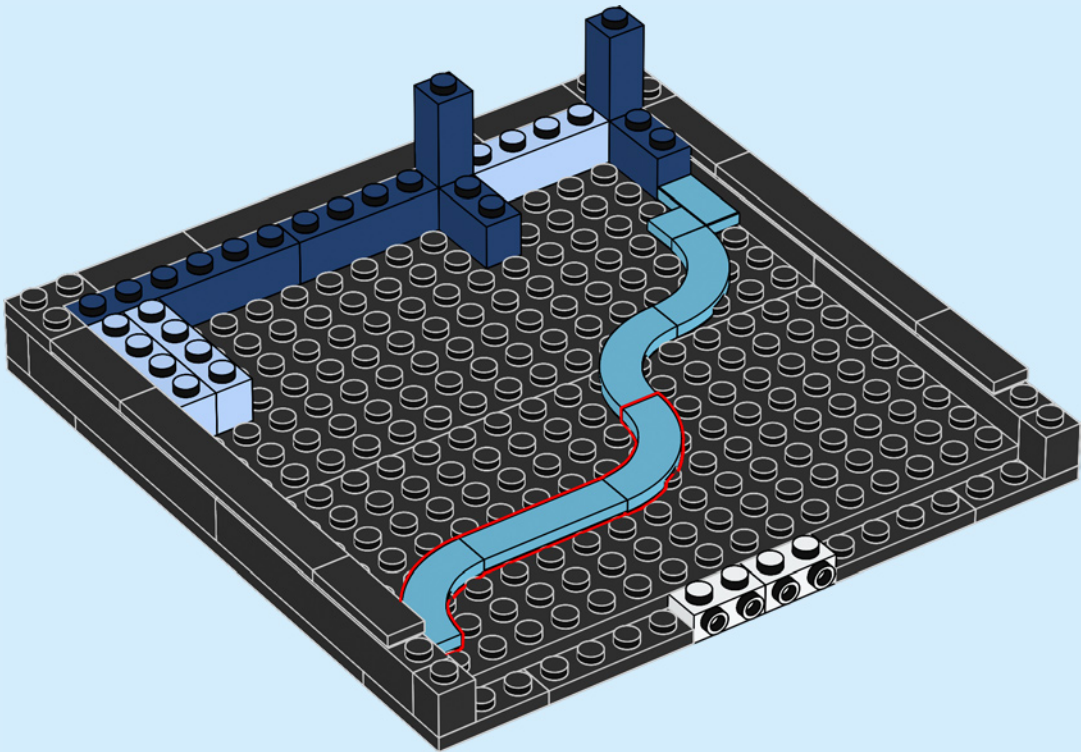

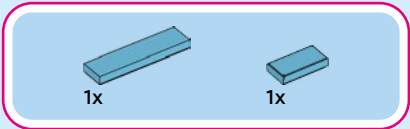

16

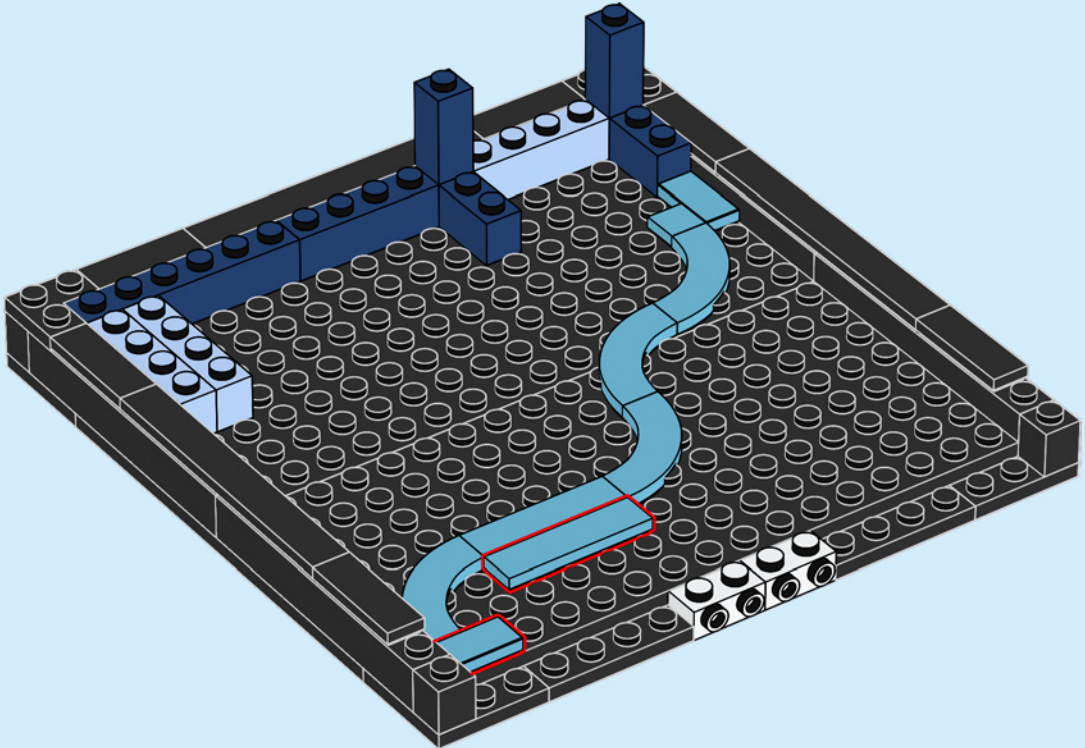

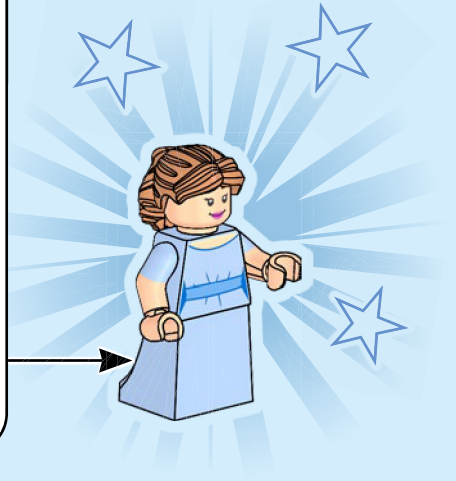
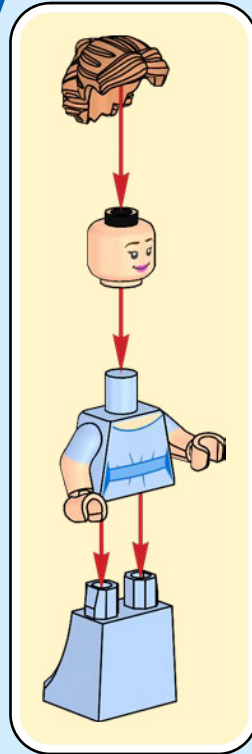

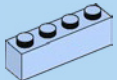

3x

17

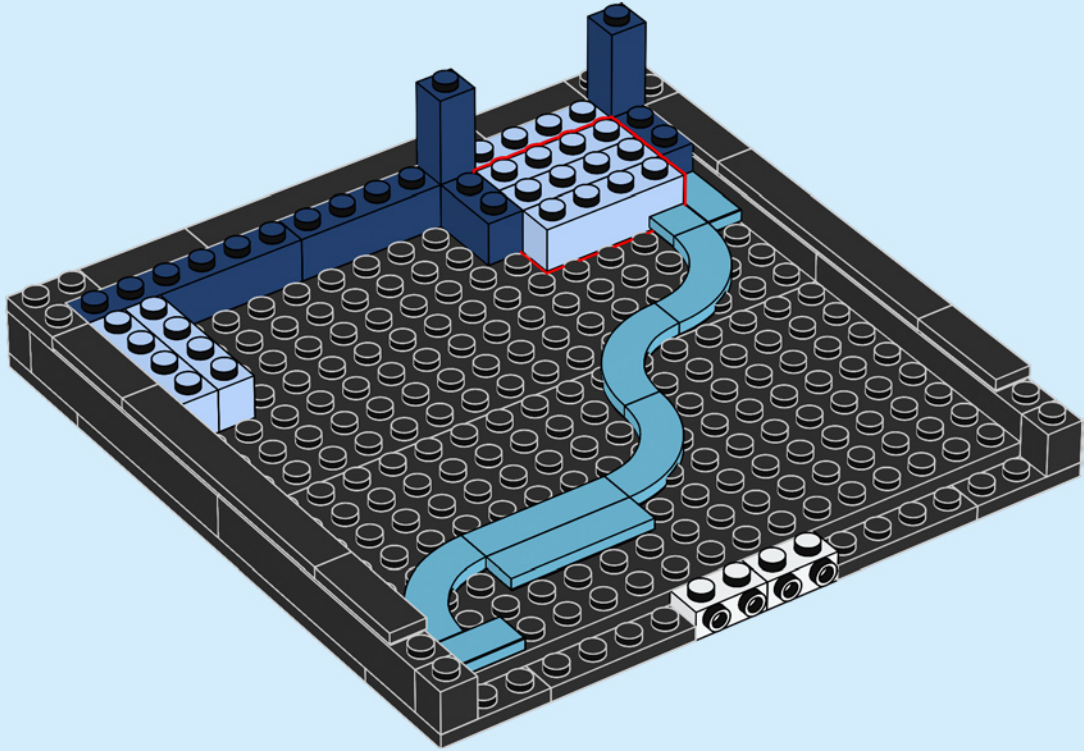



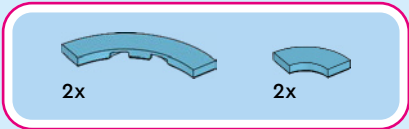

18

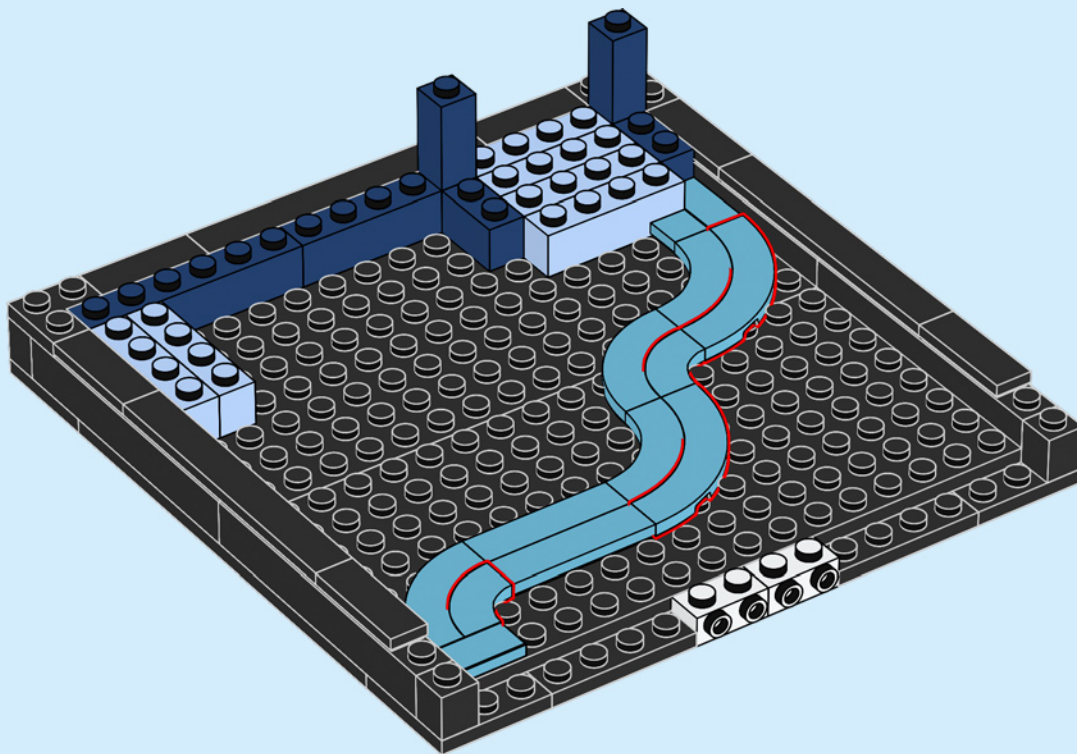

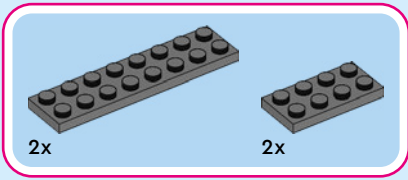

19

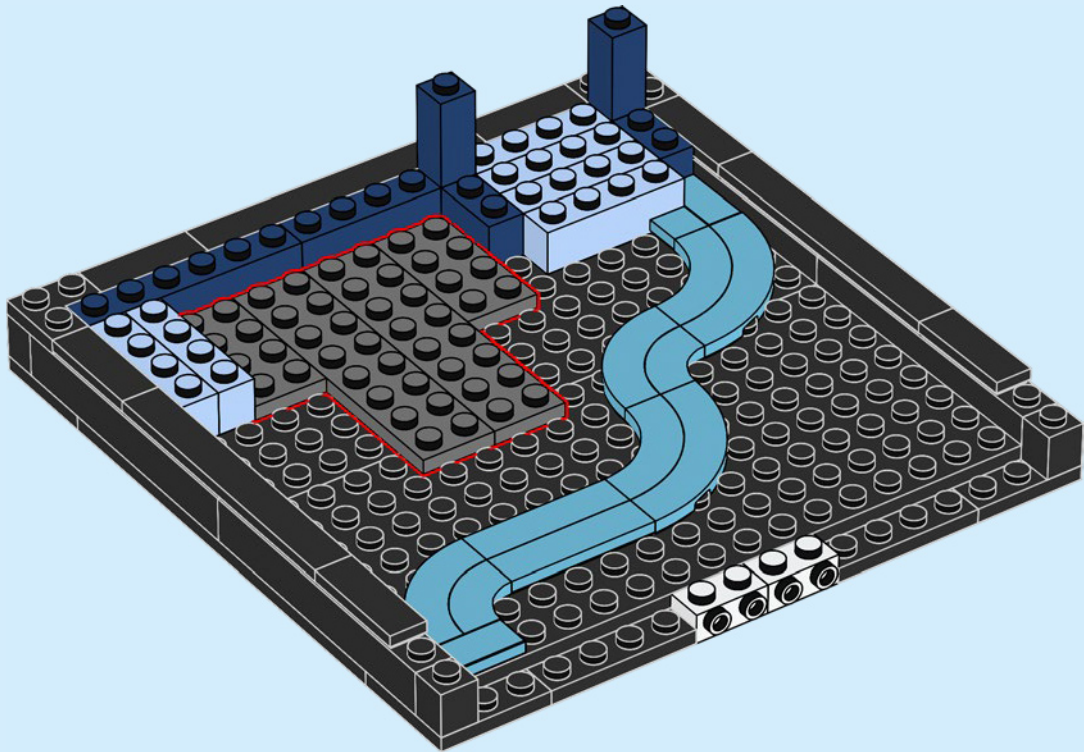

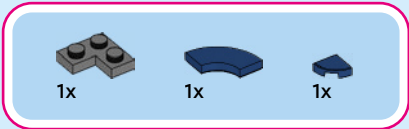

20

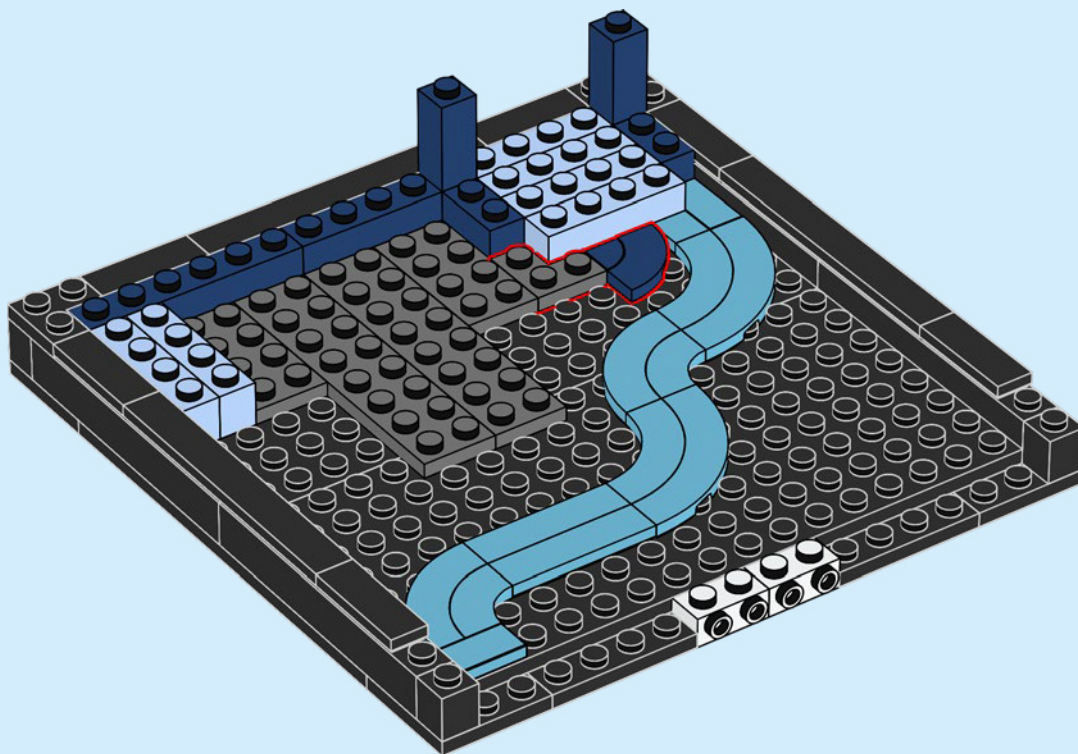

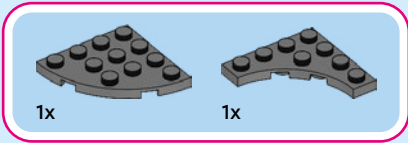

21

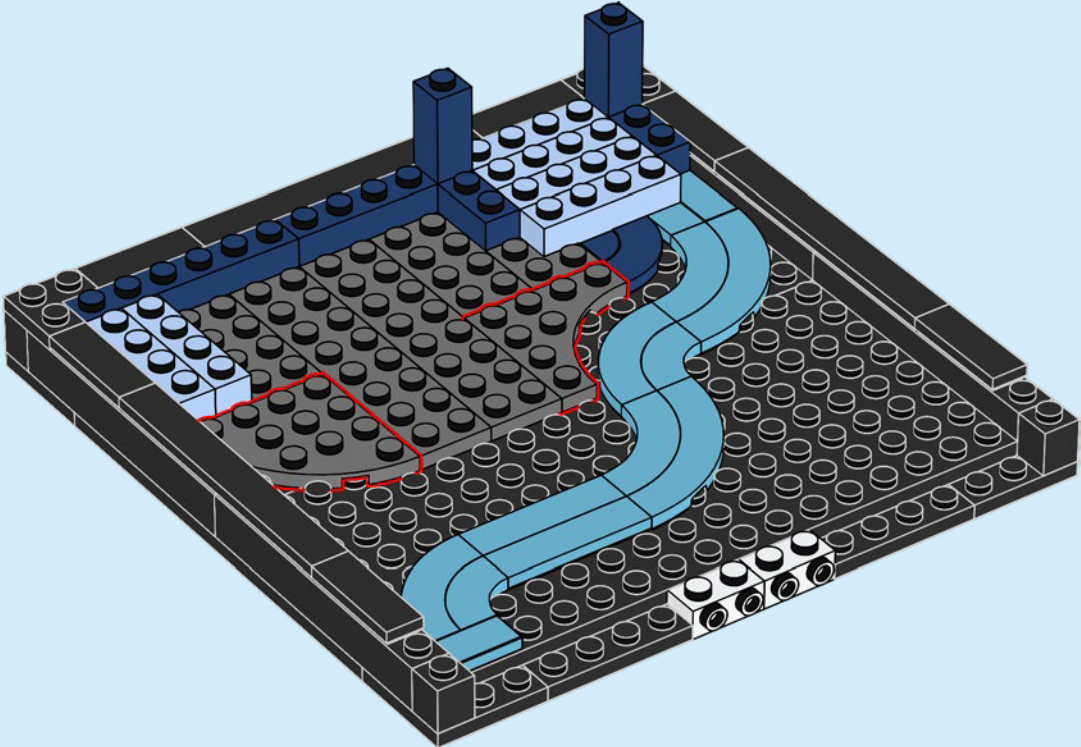

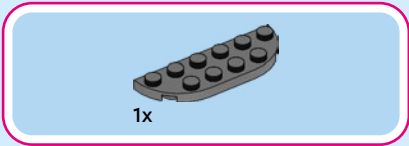

22

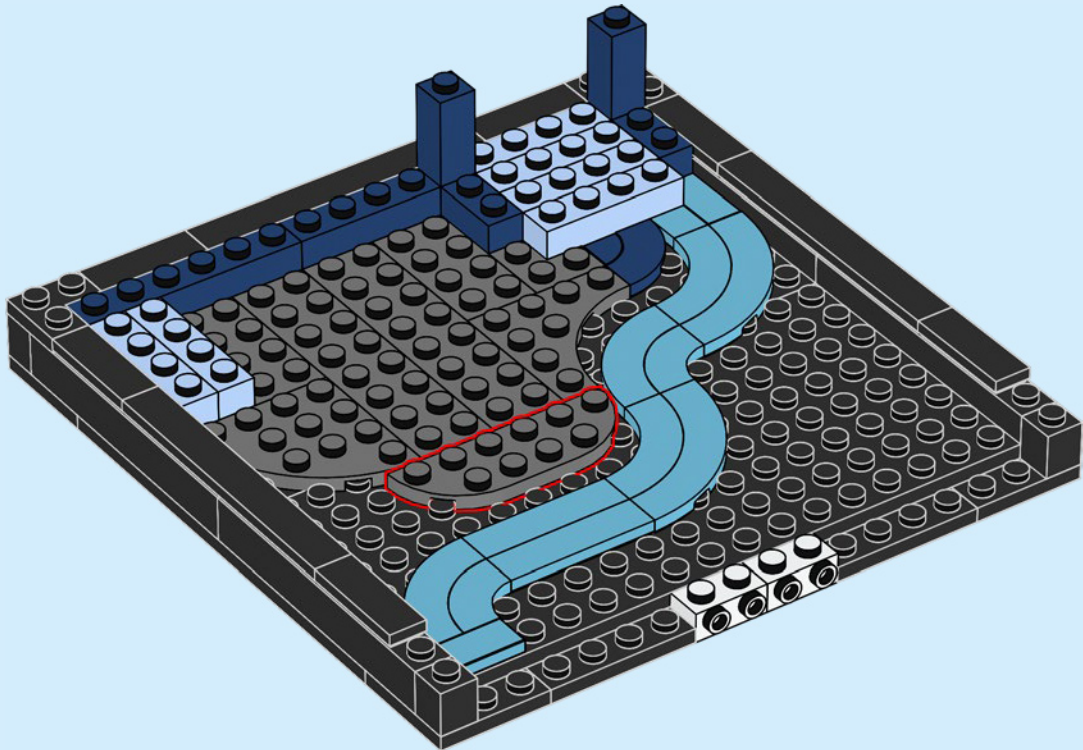

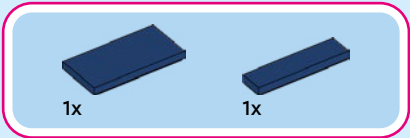

23

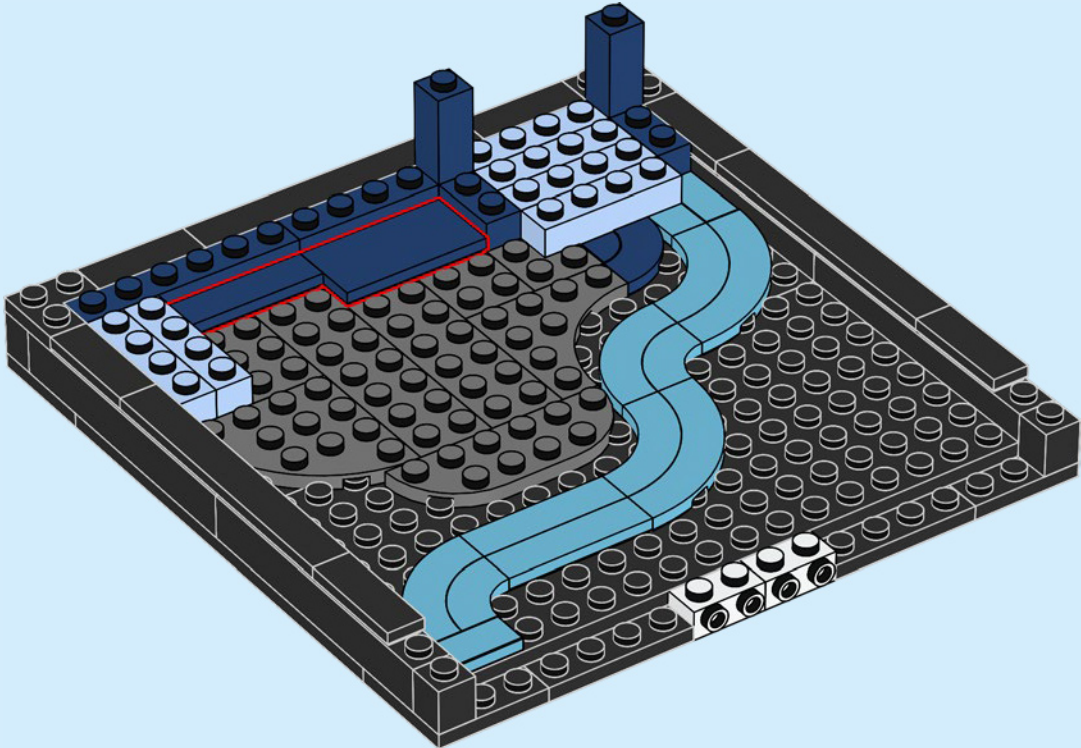

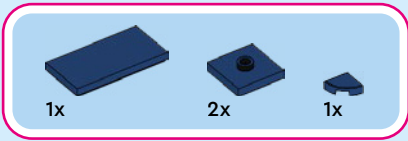

24

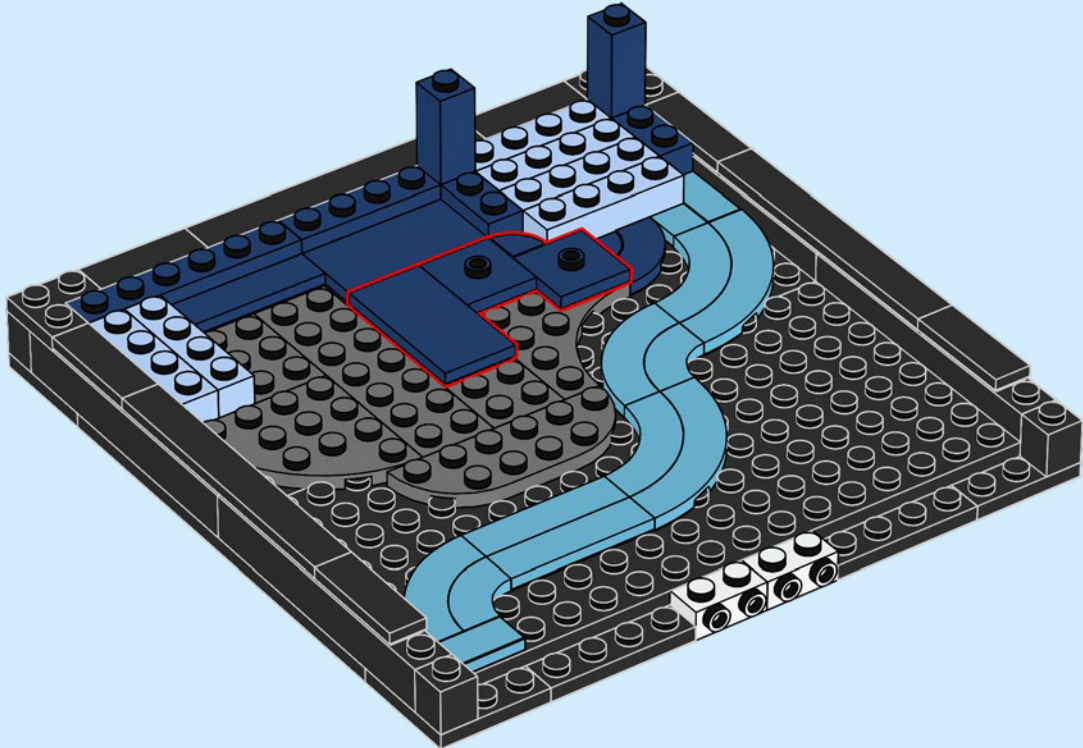

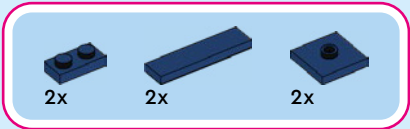

25

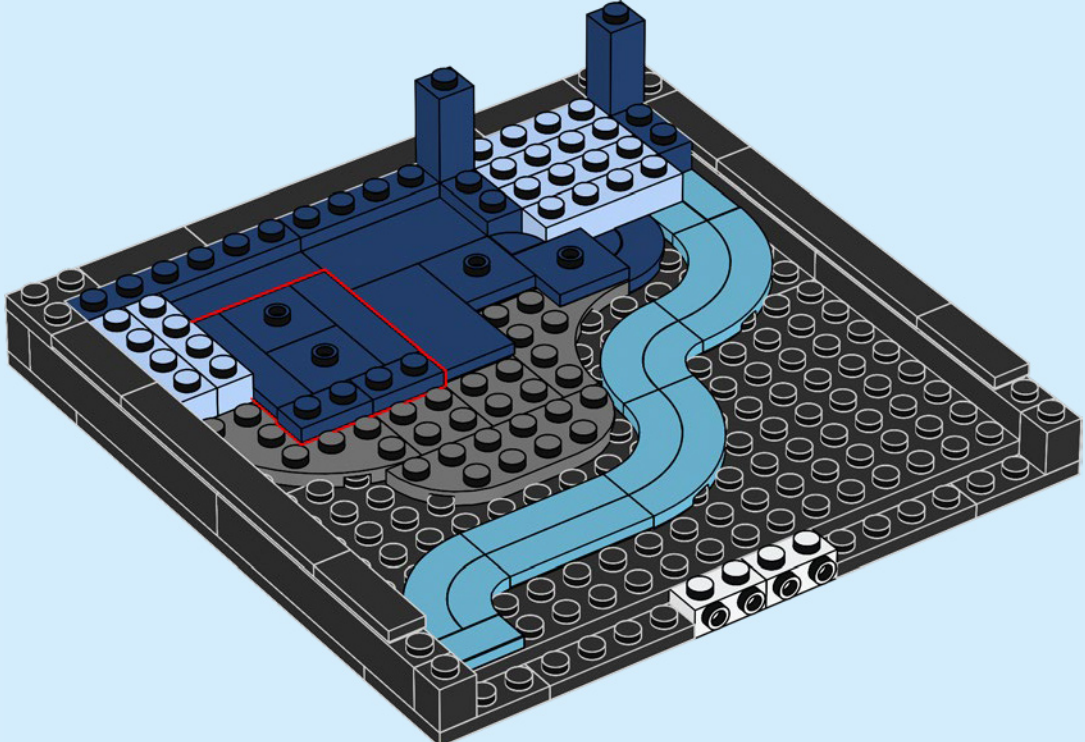



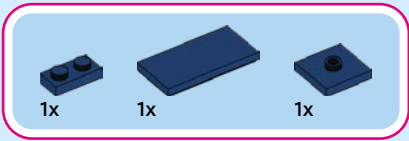

26

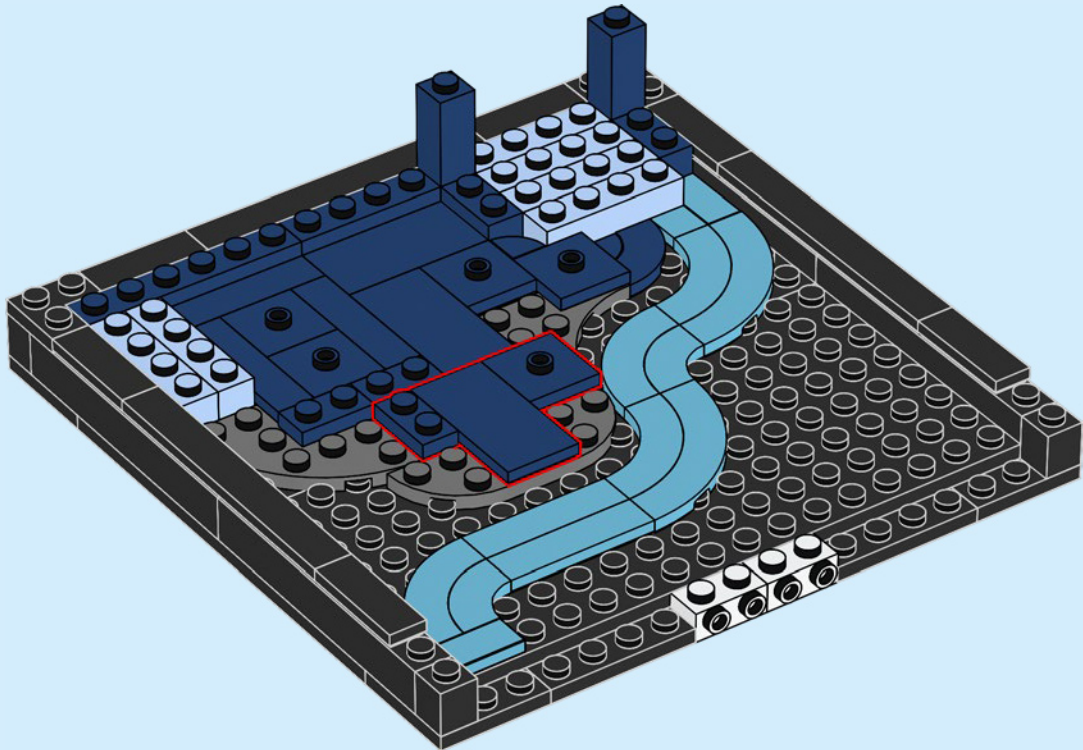



3x

27

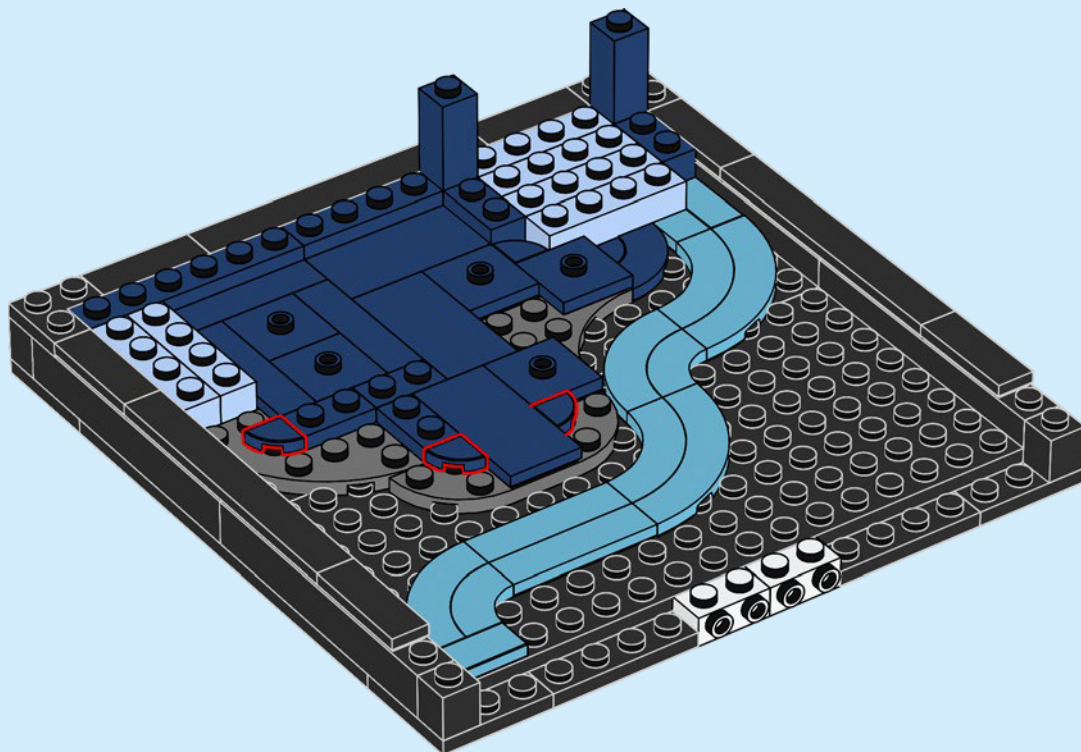



5x

28

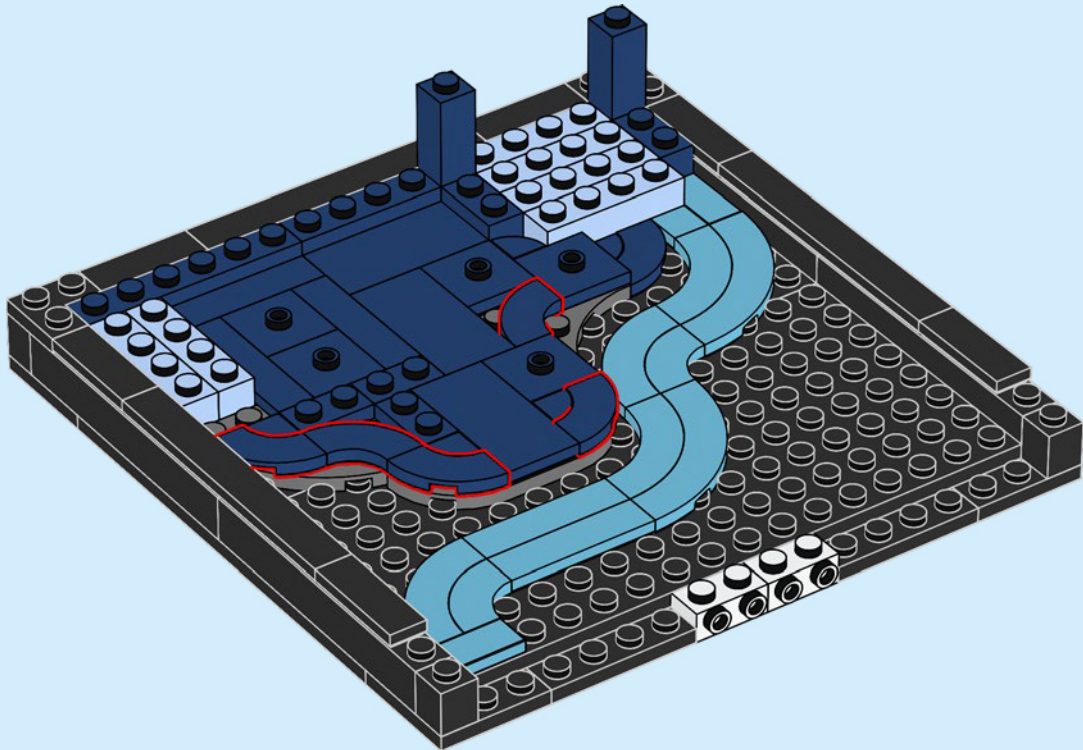

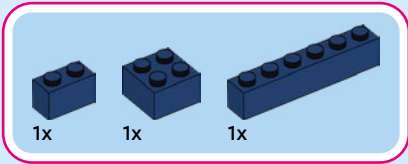

29

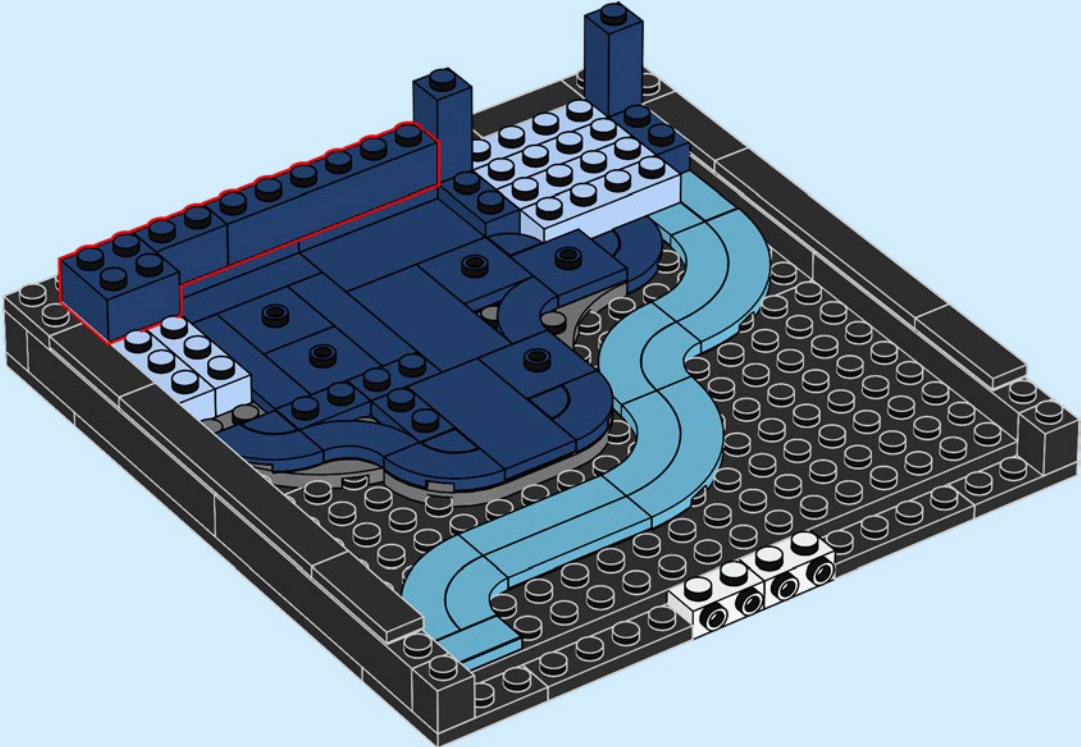

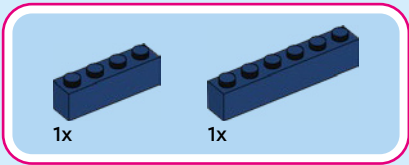

30

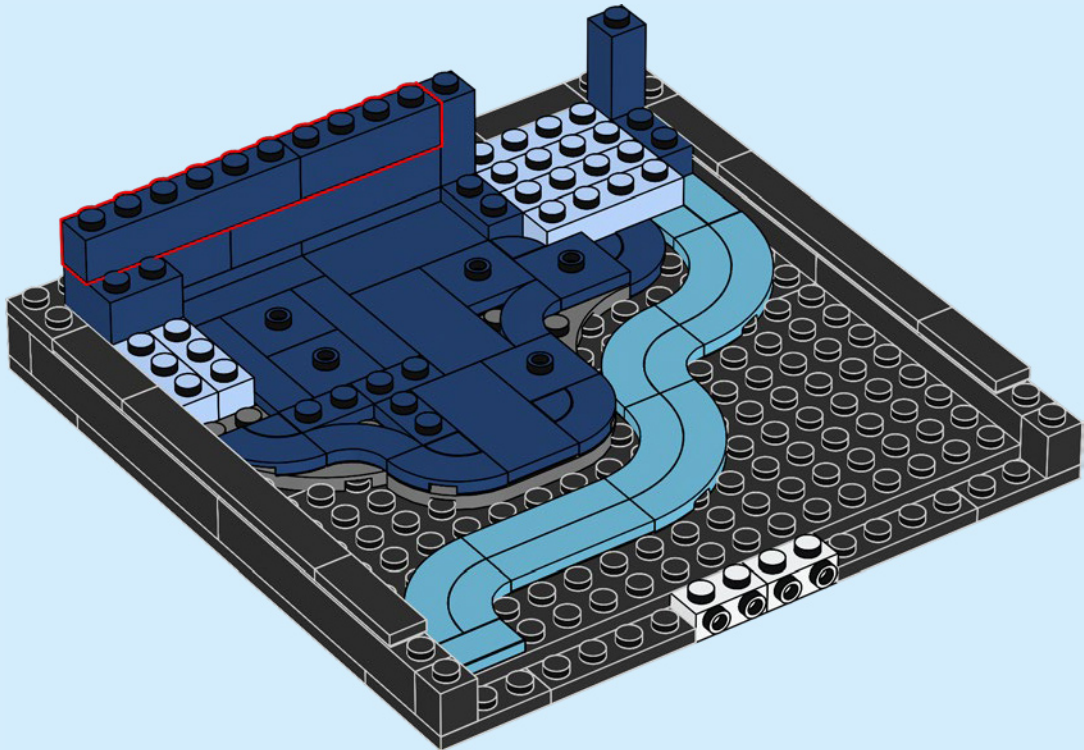

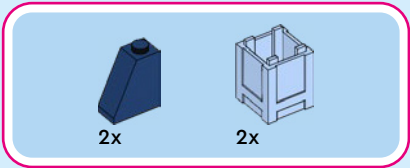

31

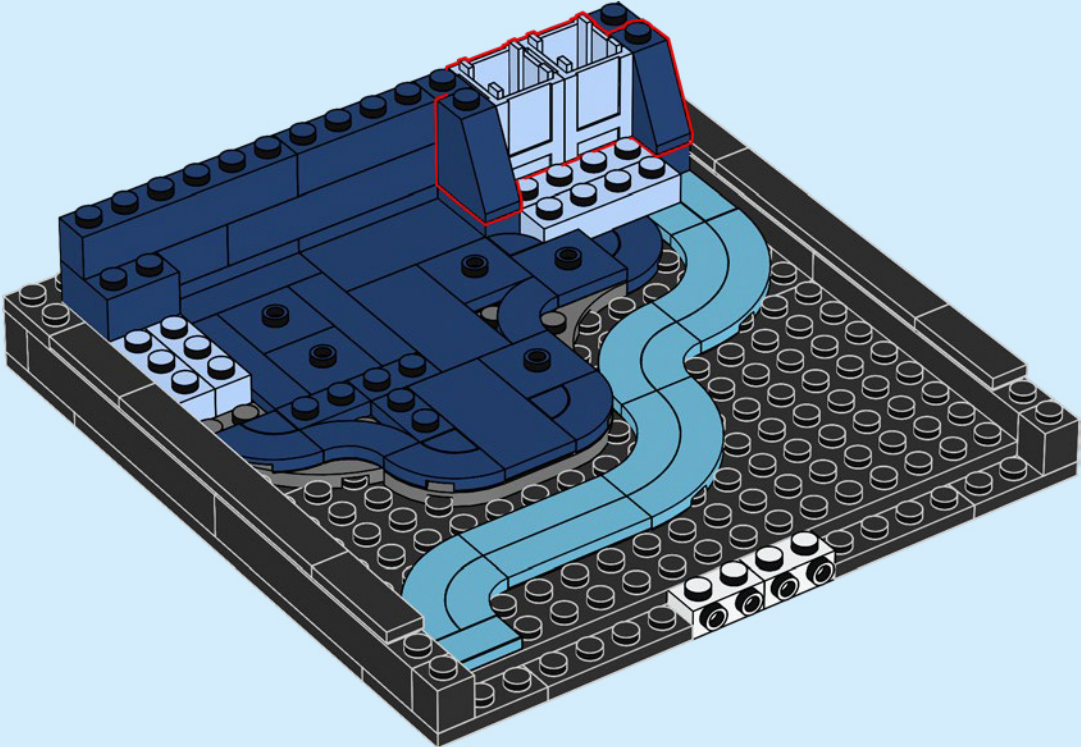

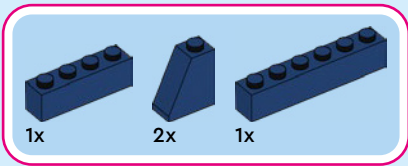

32

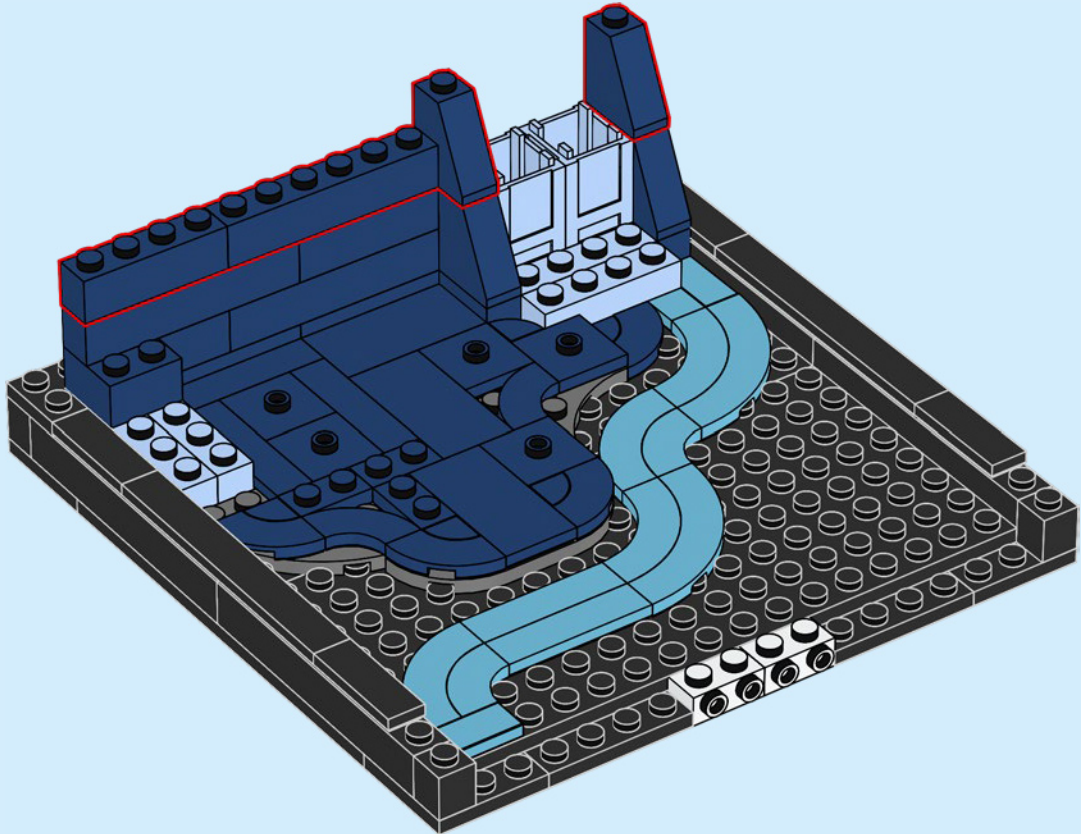

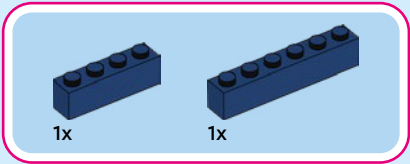

33

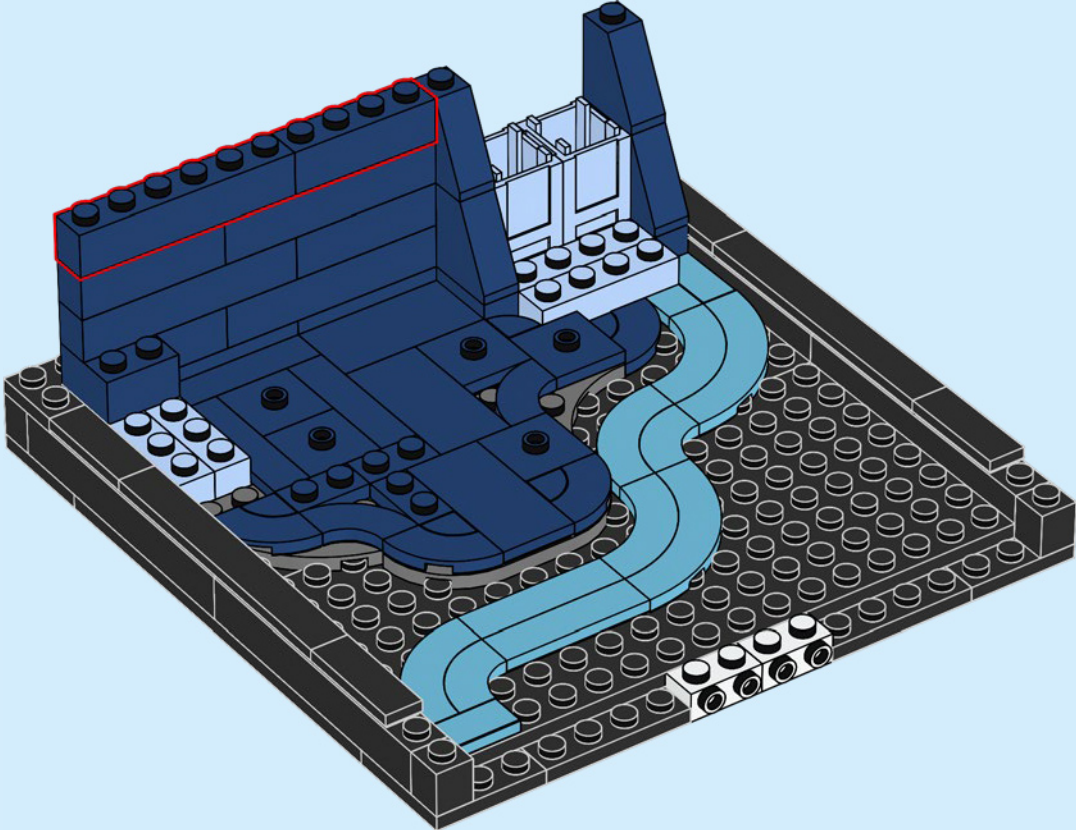



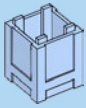

2x

34

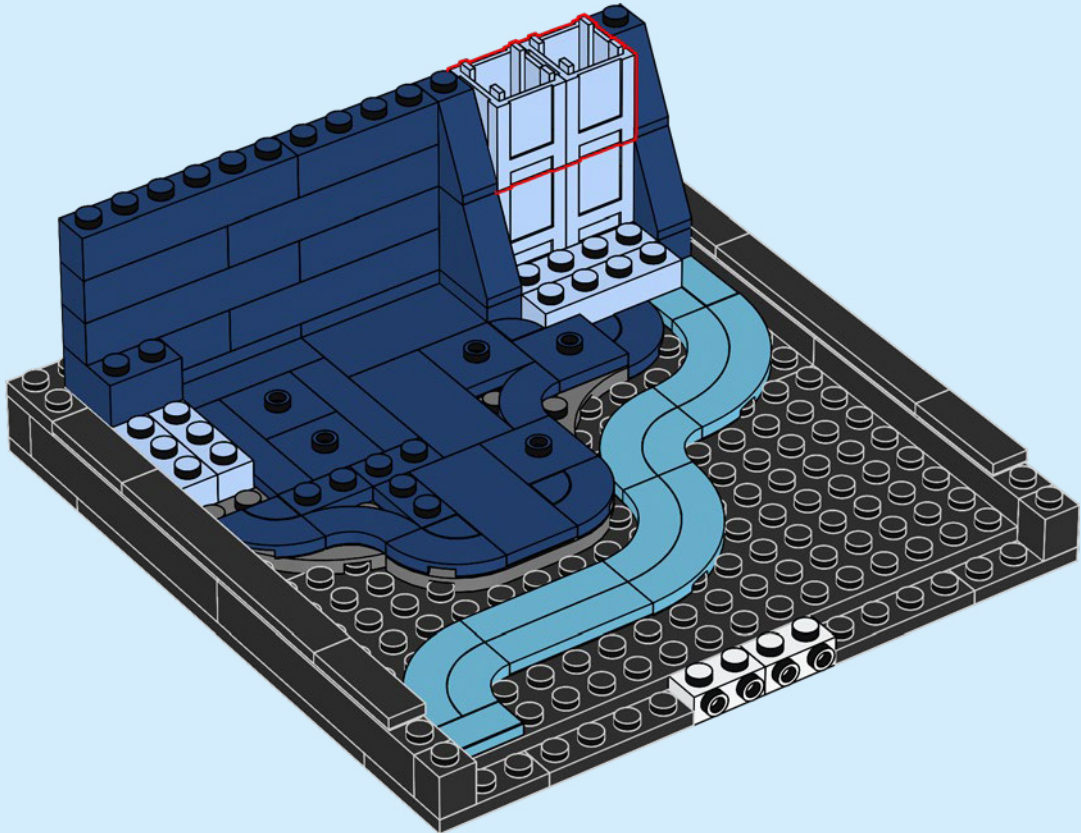

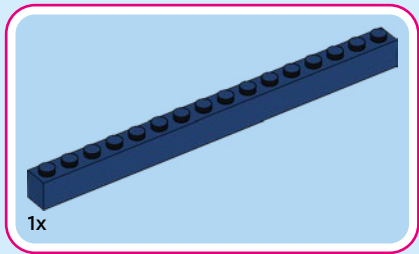

35

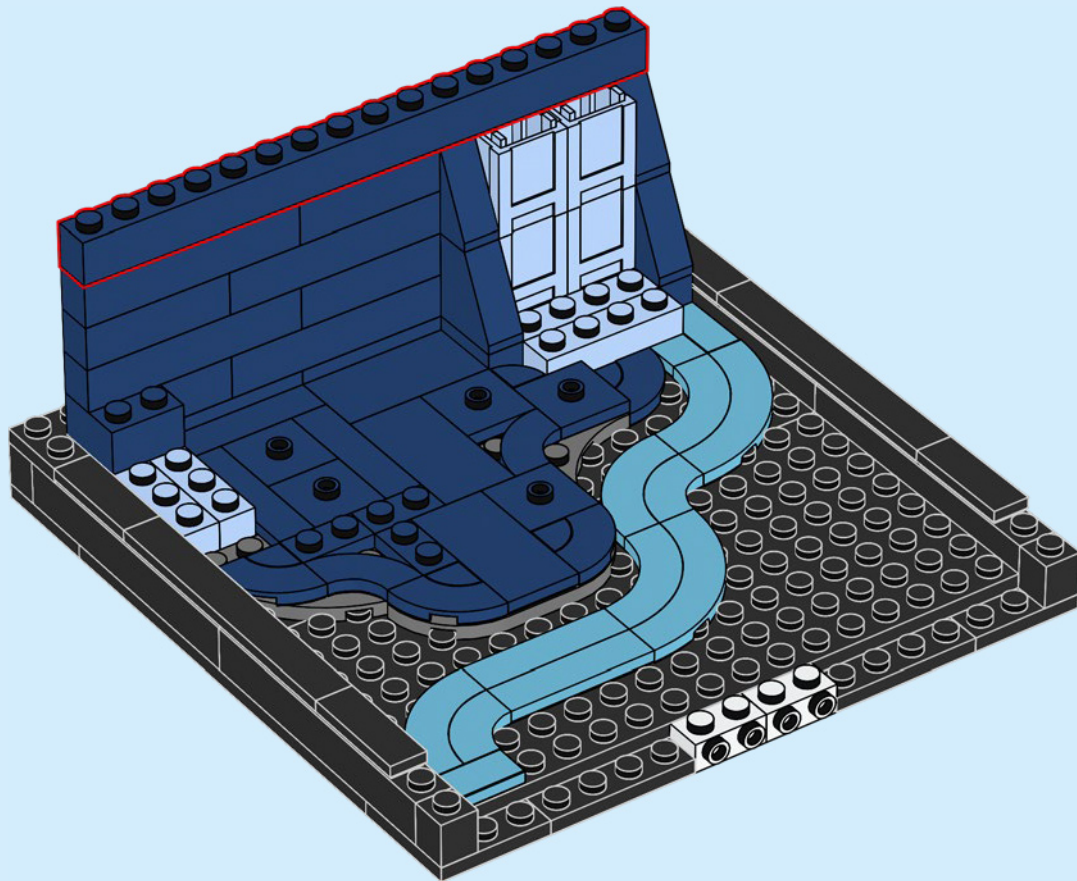

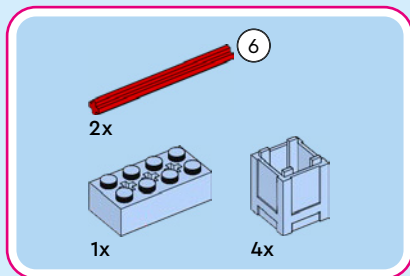

36

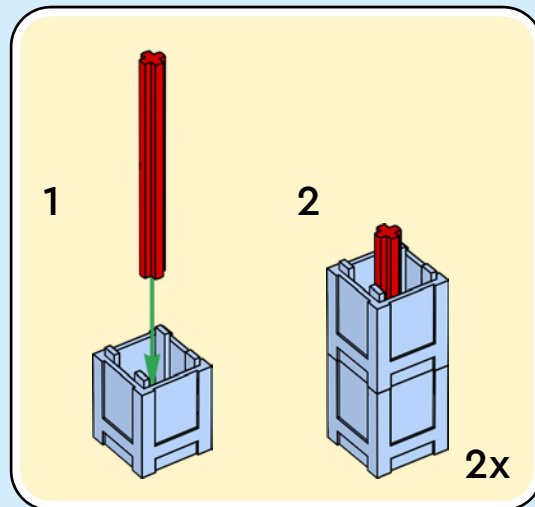

1

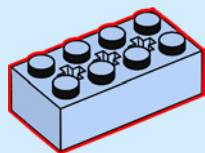

2

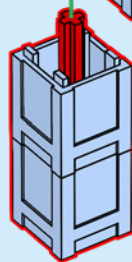
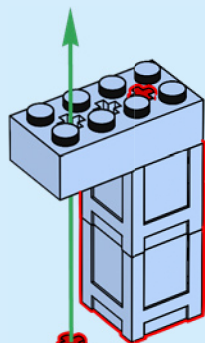

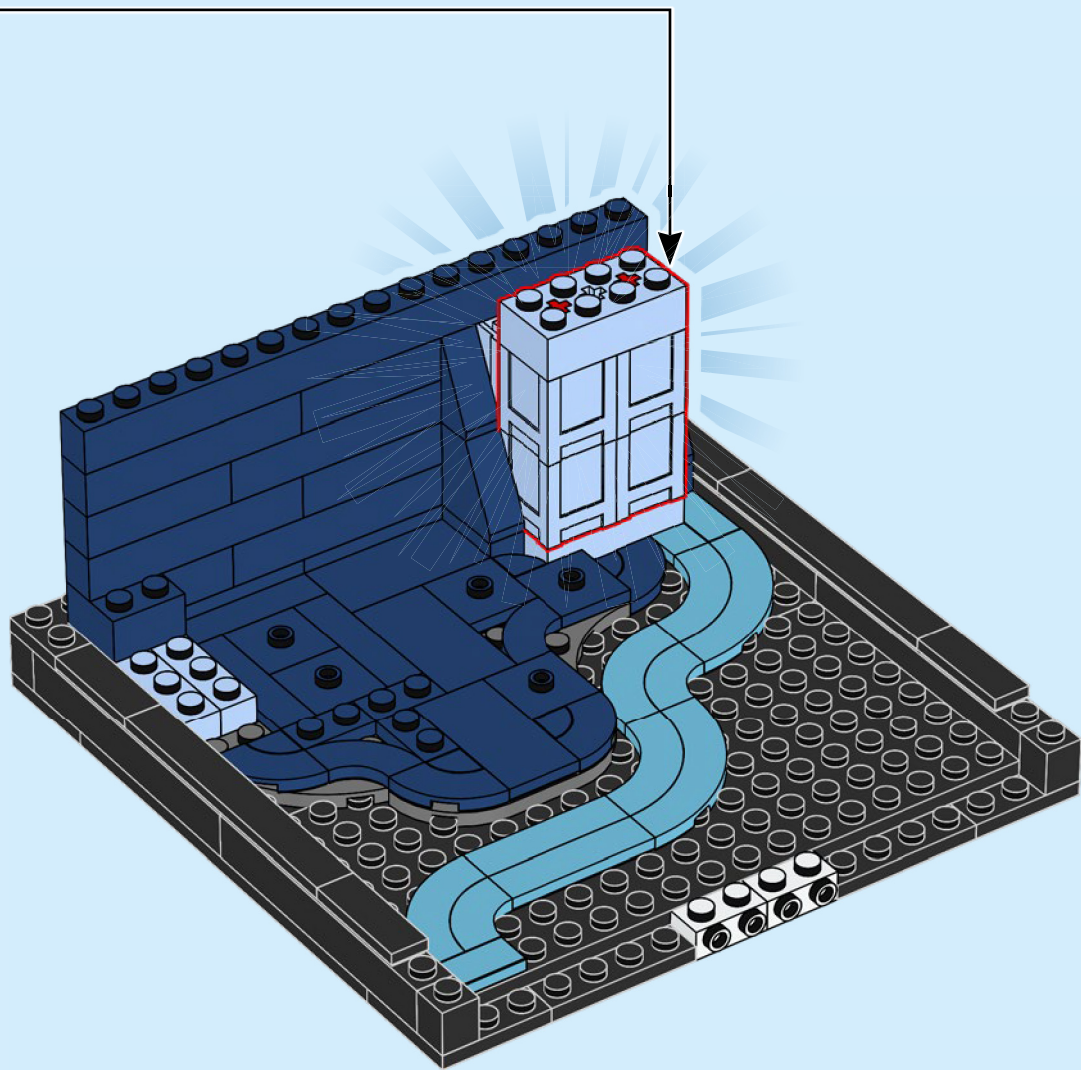

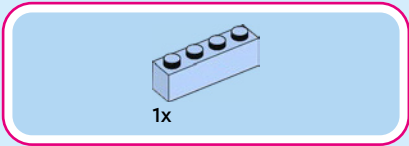

37

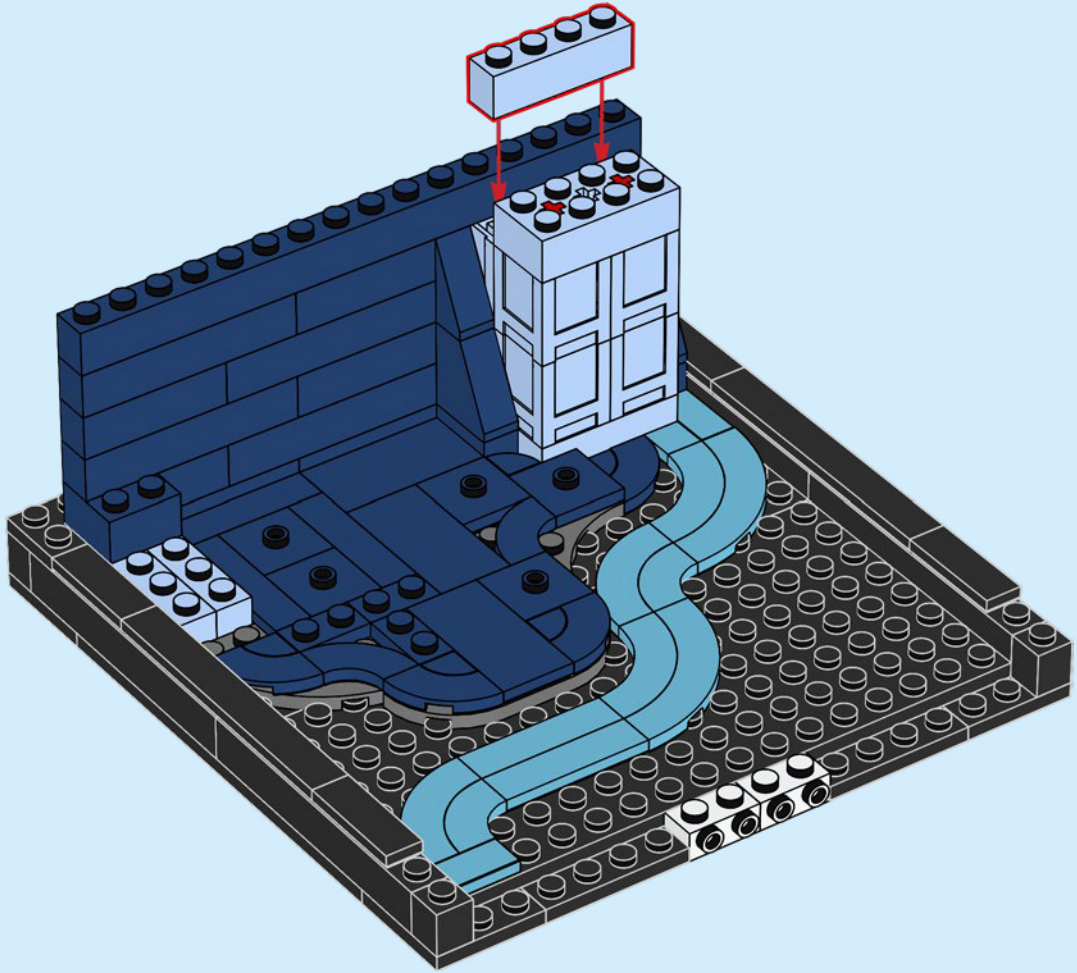

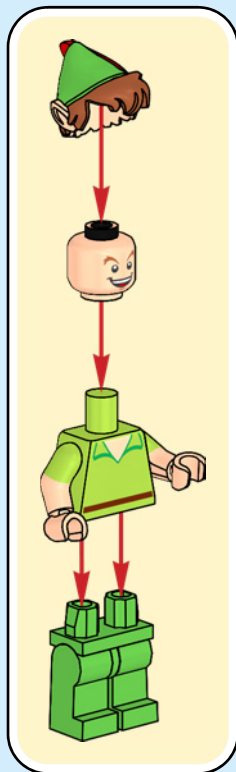

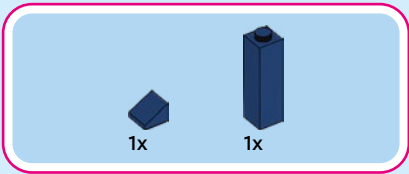

38

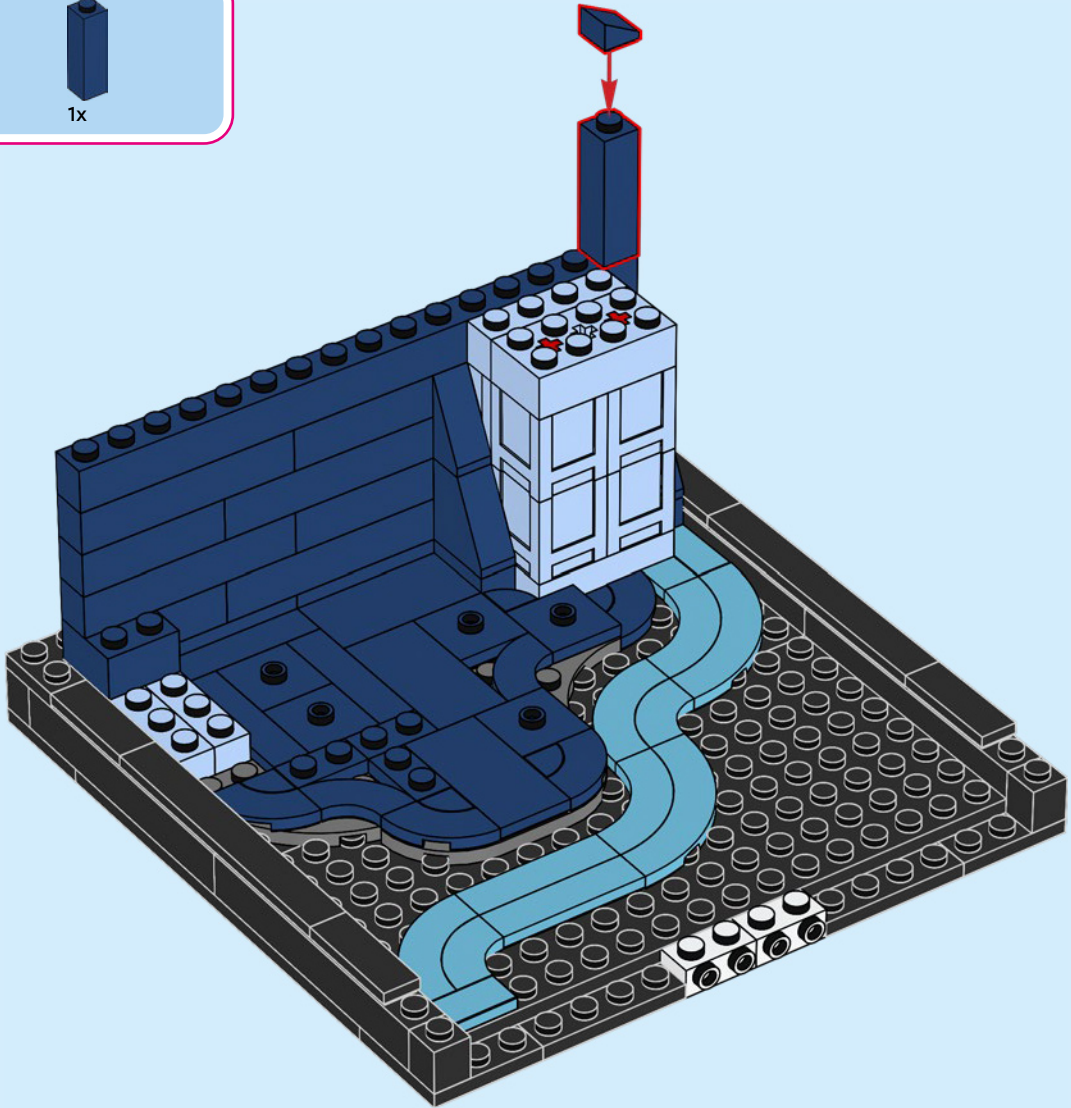

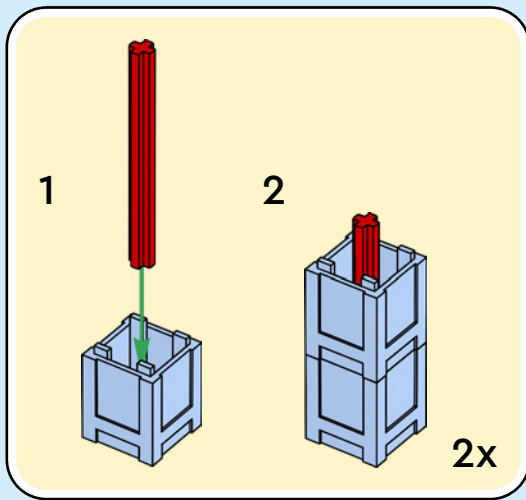
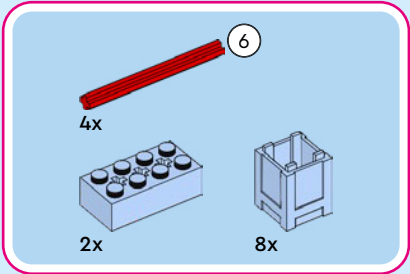
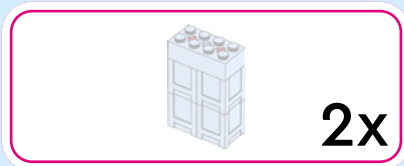

39

1

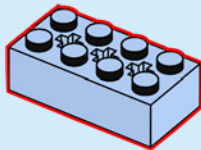

2

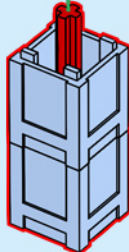
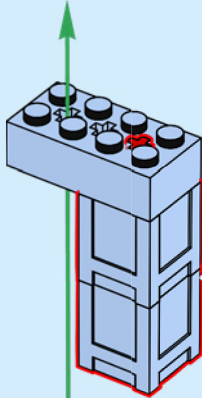

2x





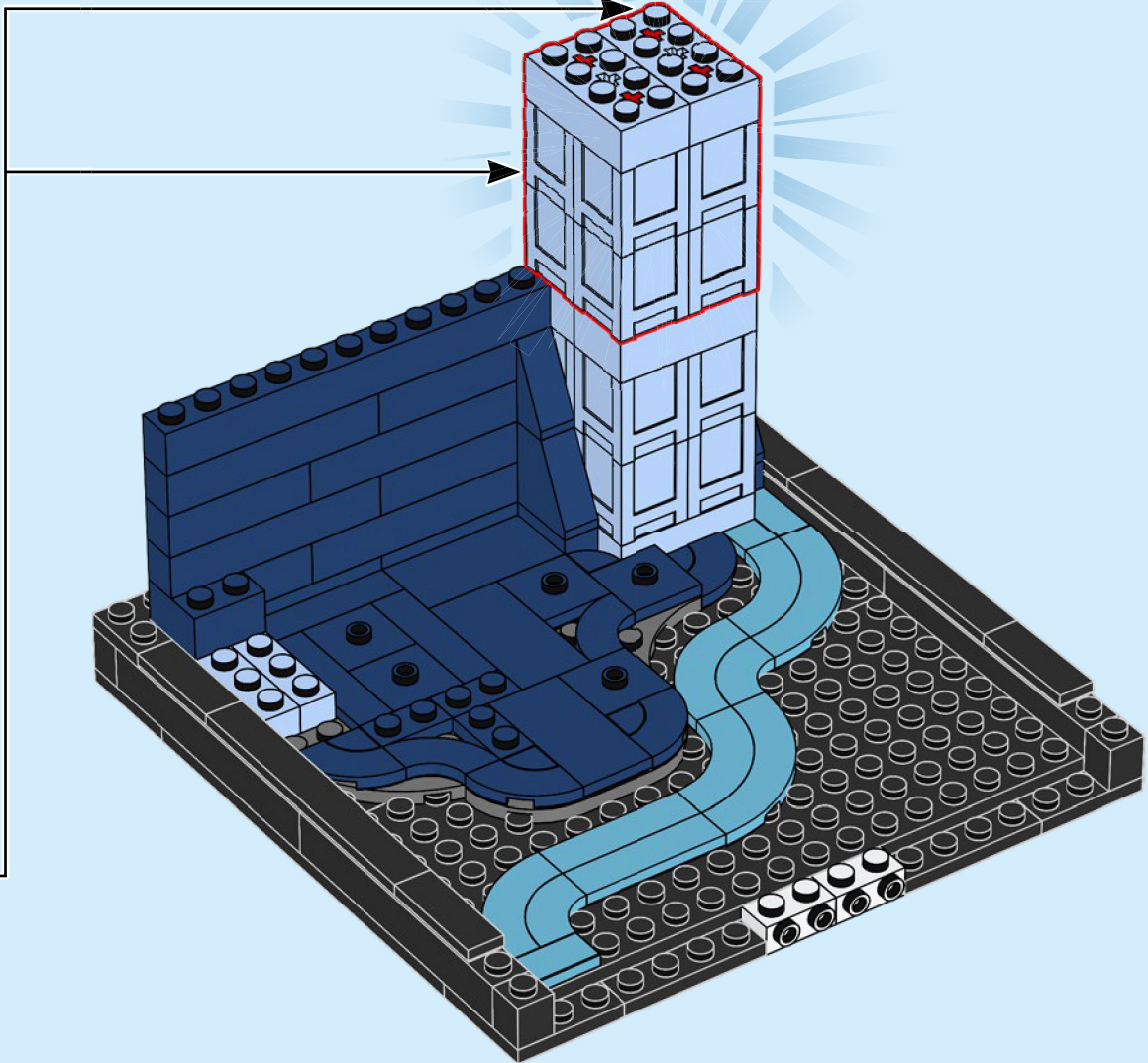

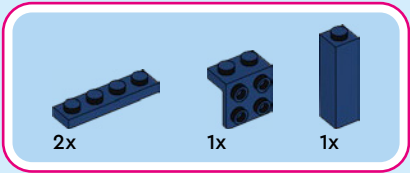

40

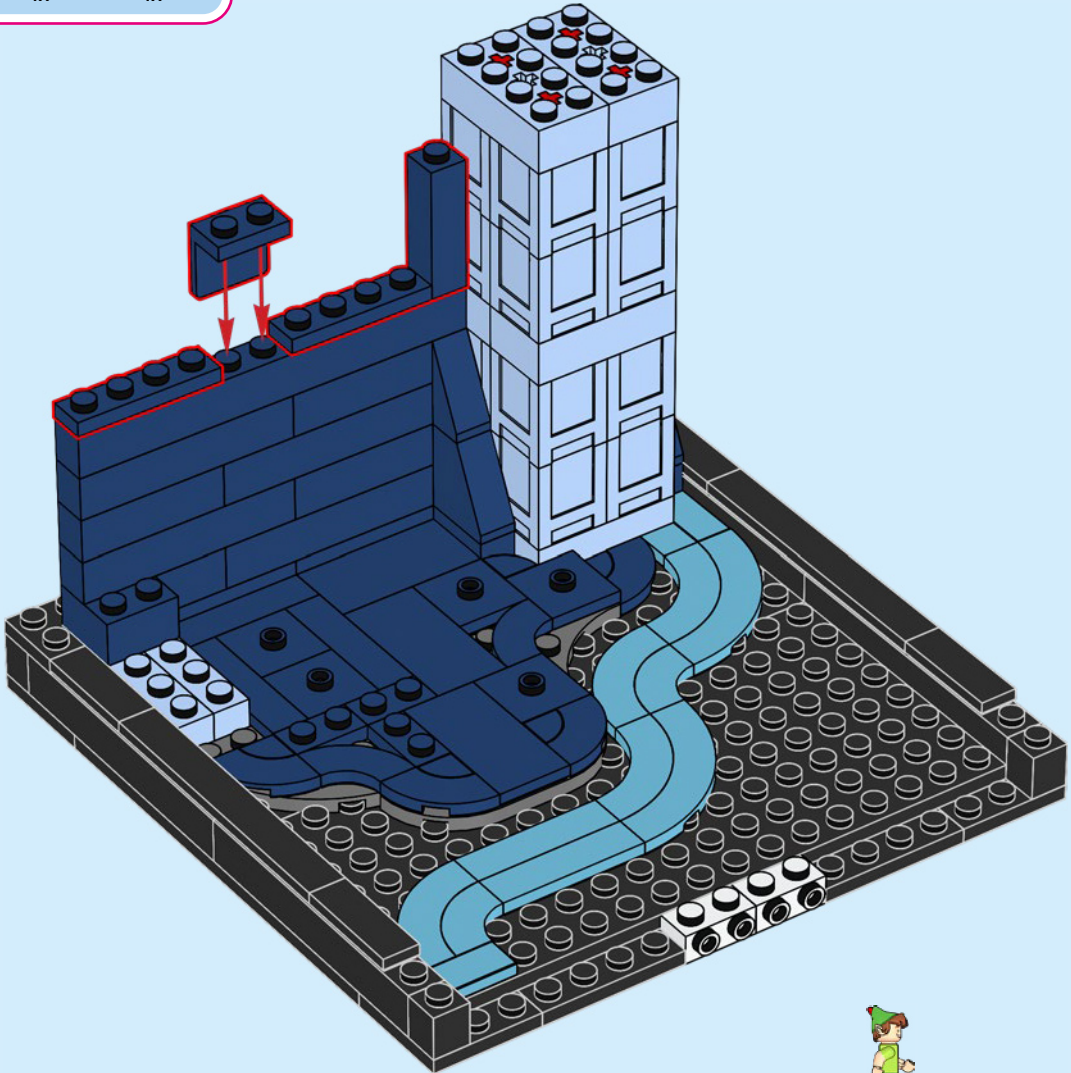

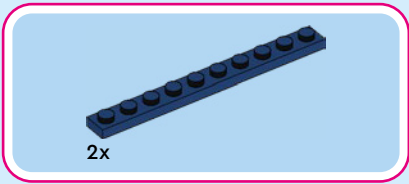

41

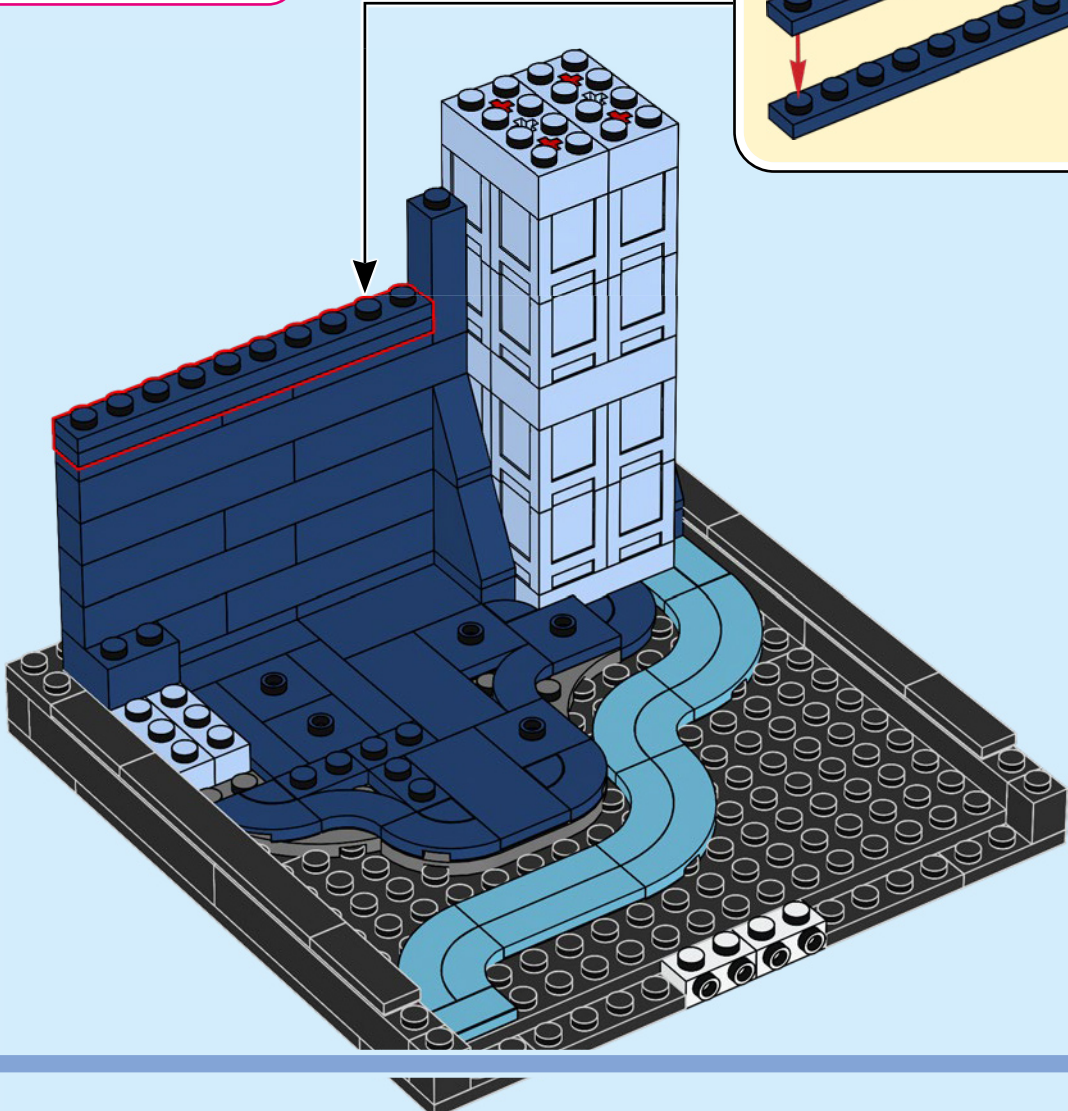
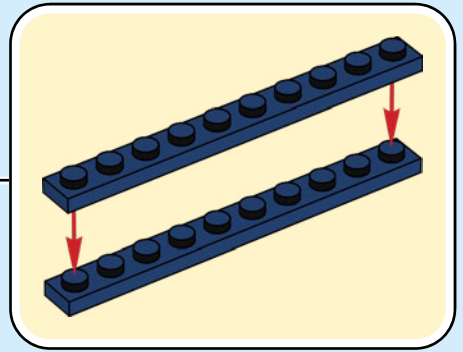

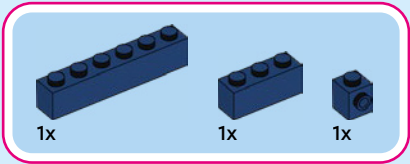

42

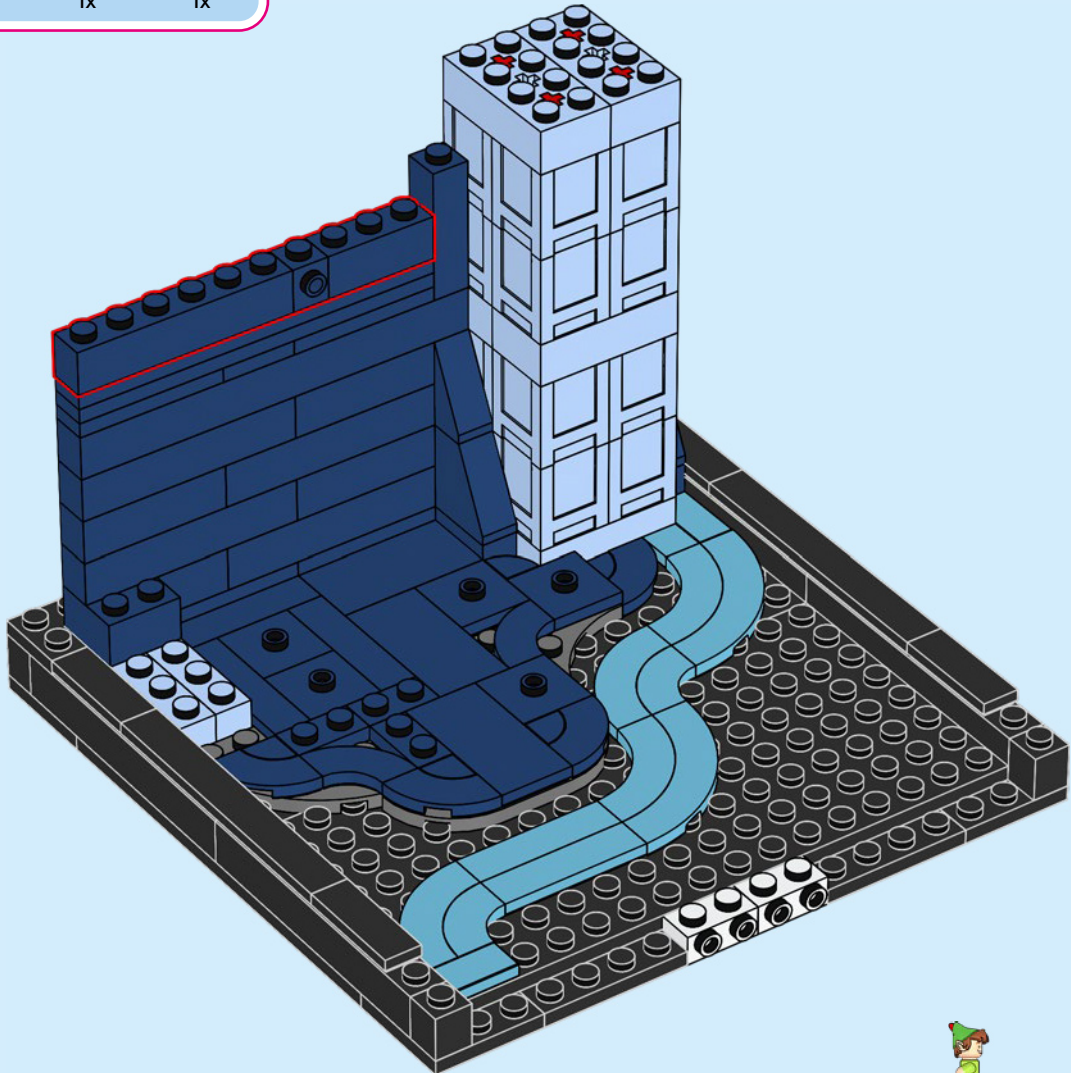

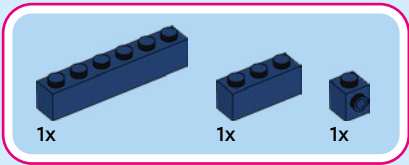

43

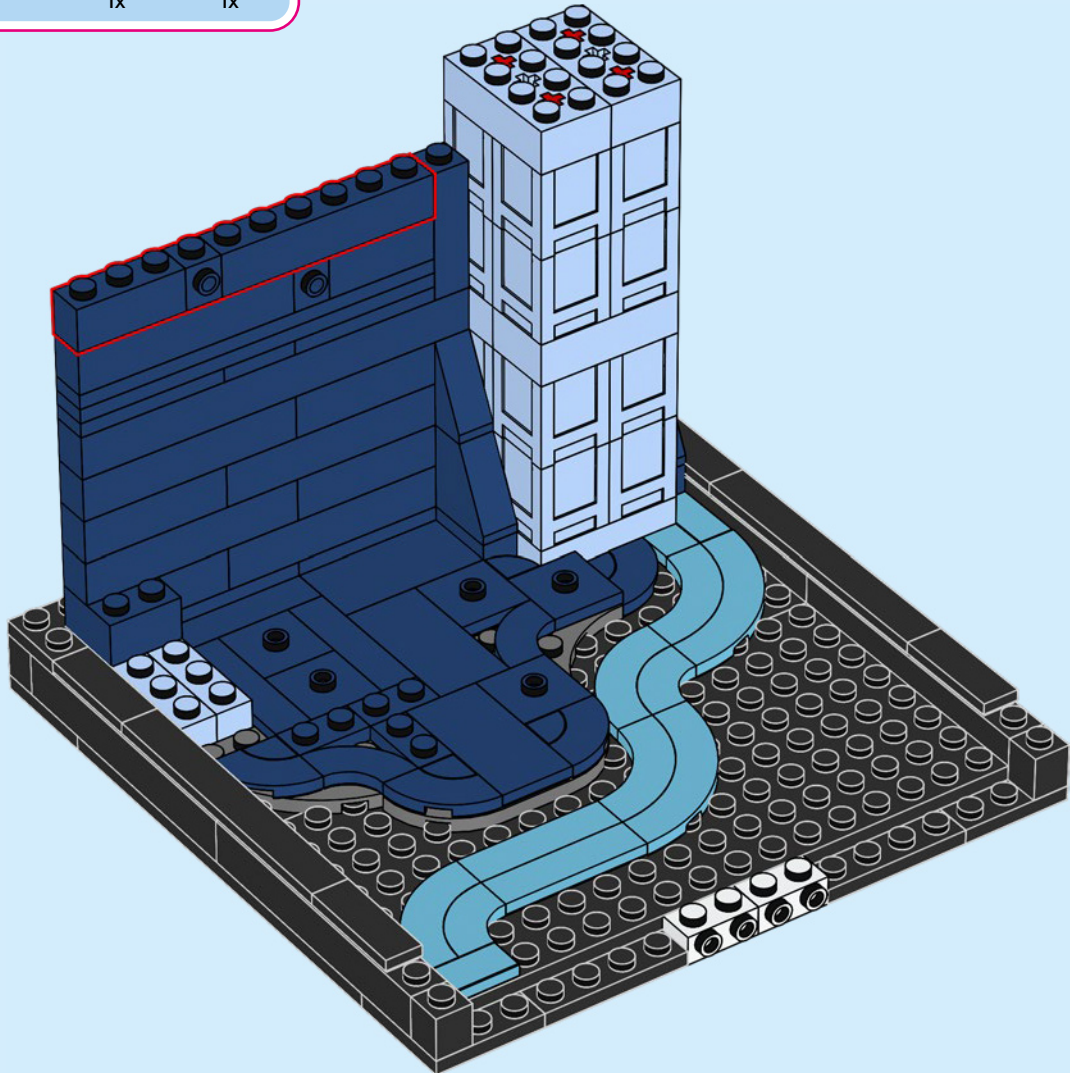

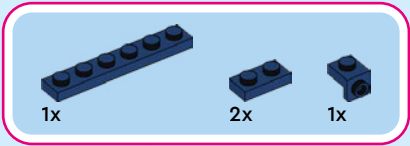

44

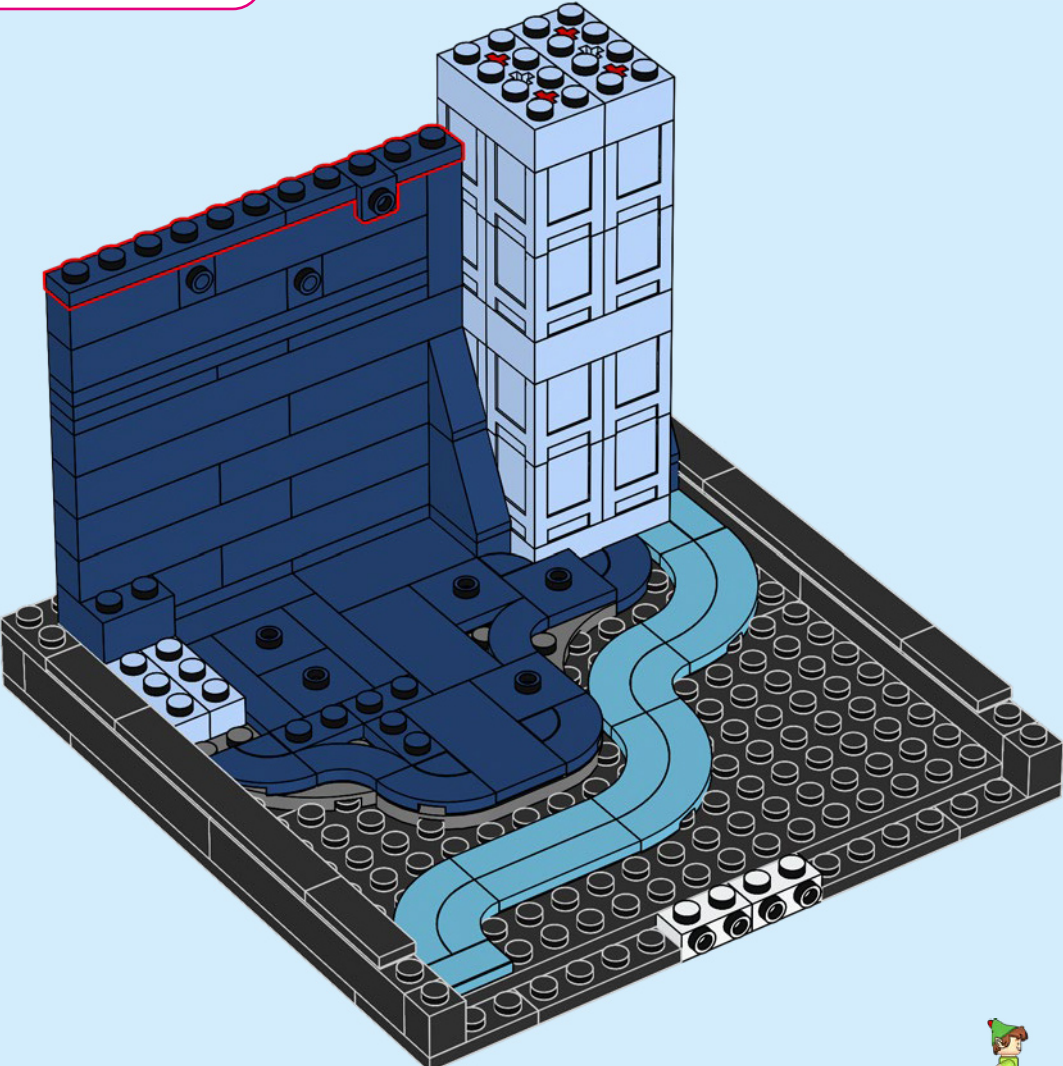

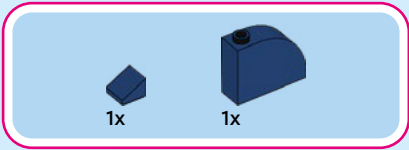

45

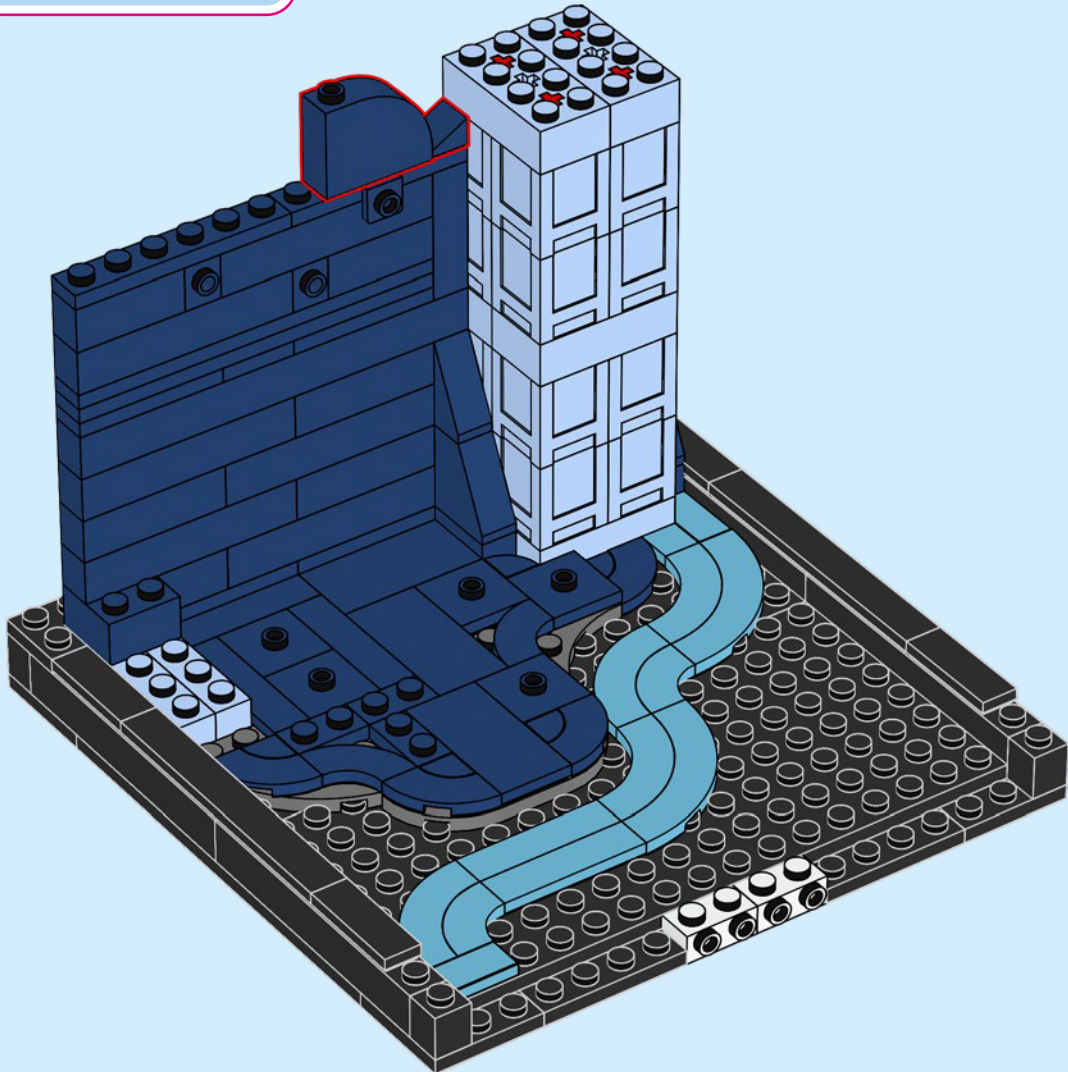

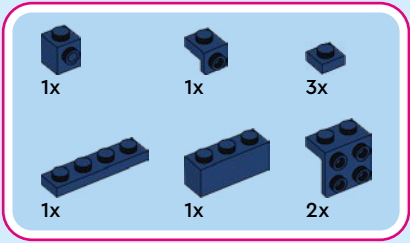

# 46

1

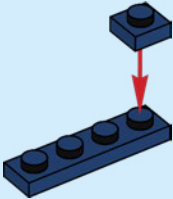

2

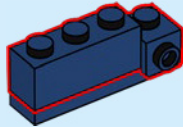

3

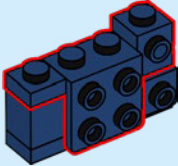

4

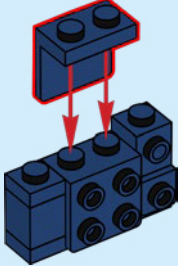

5

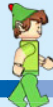
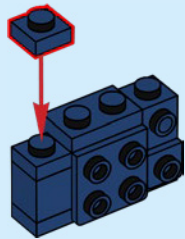



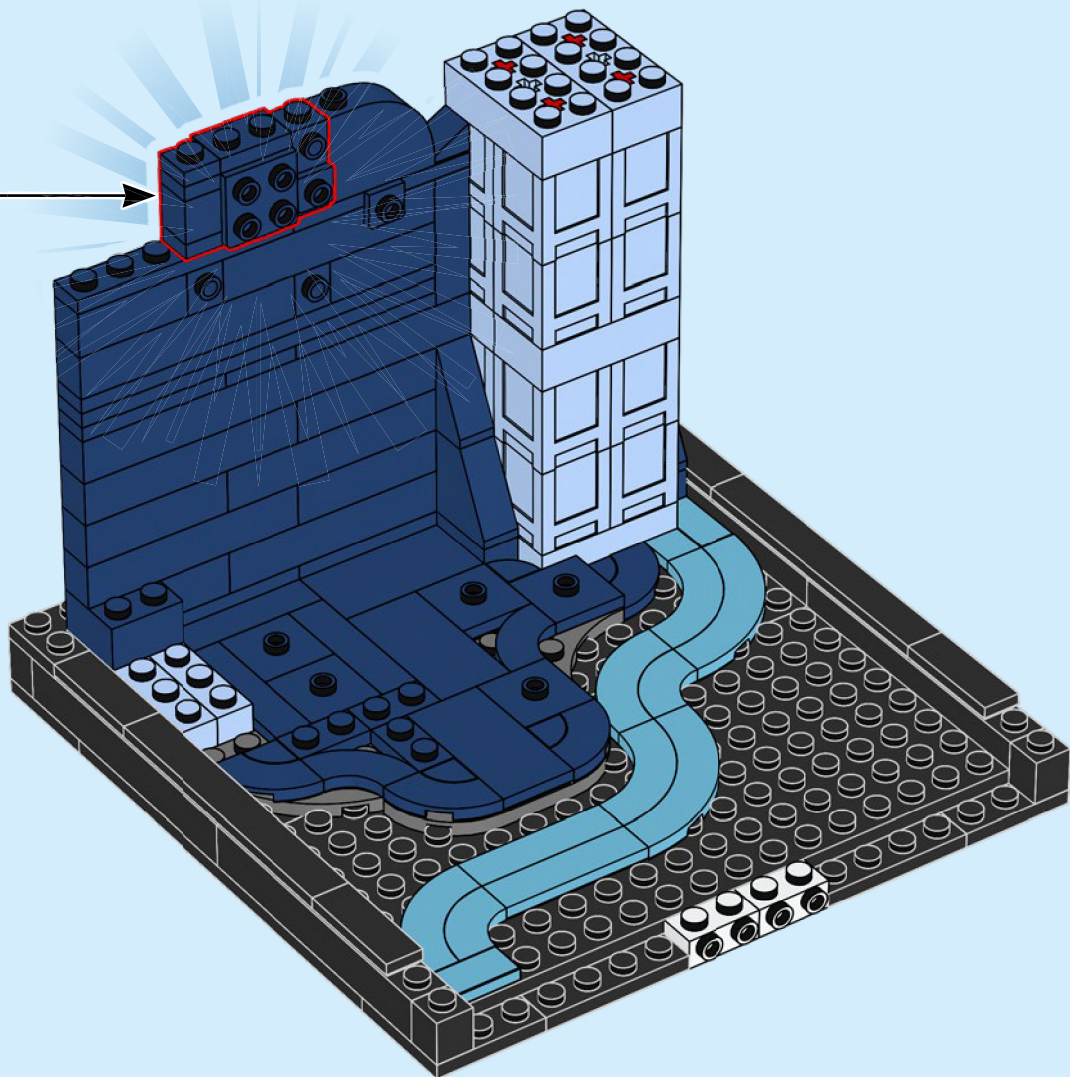



1x

47

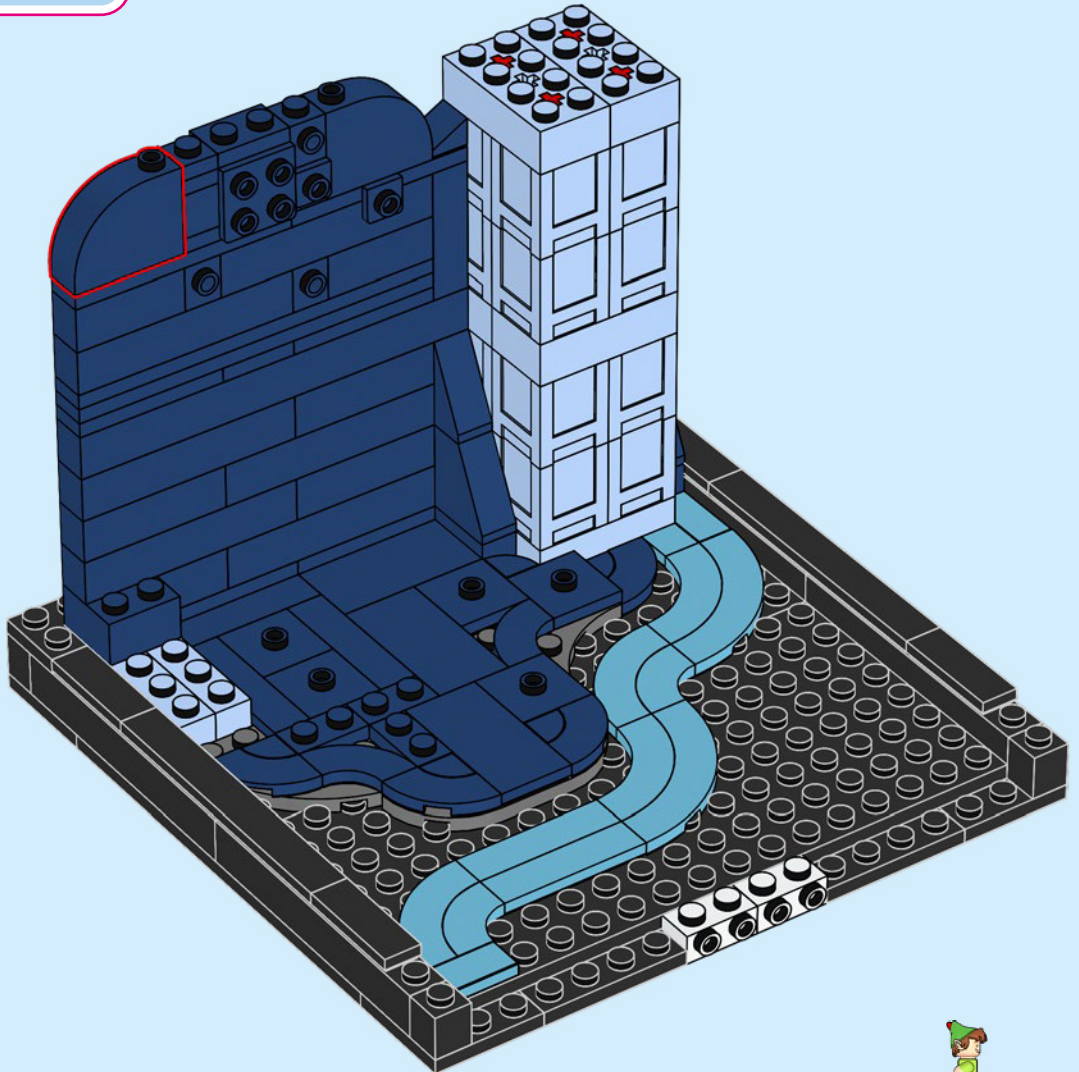

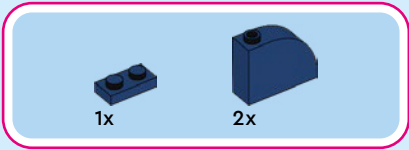

48

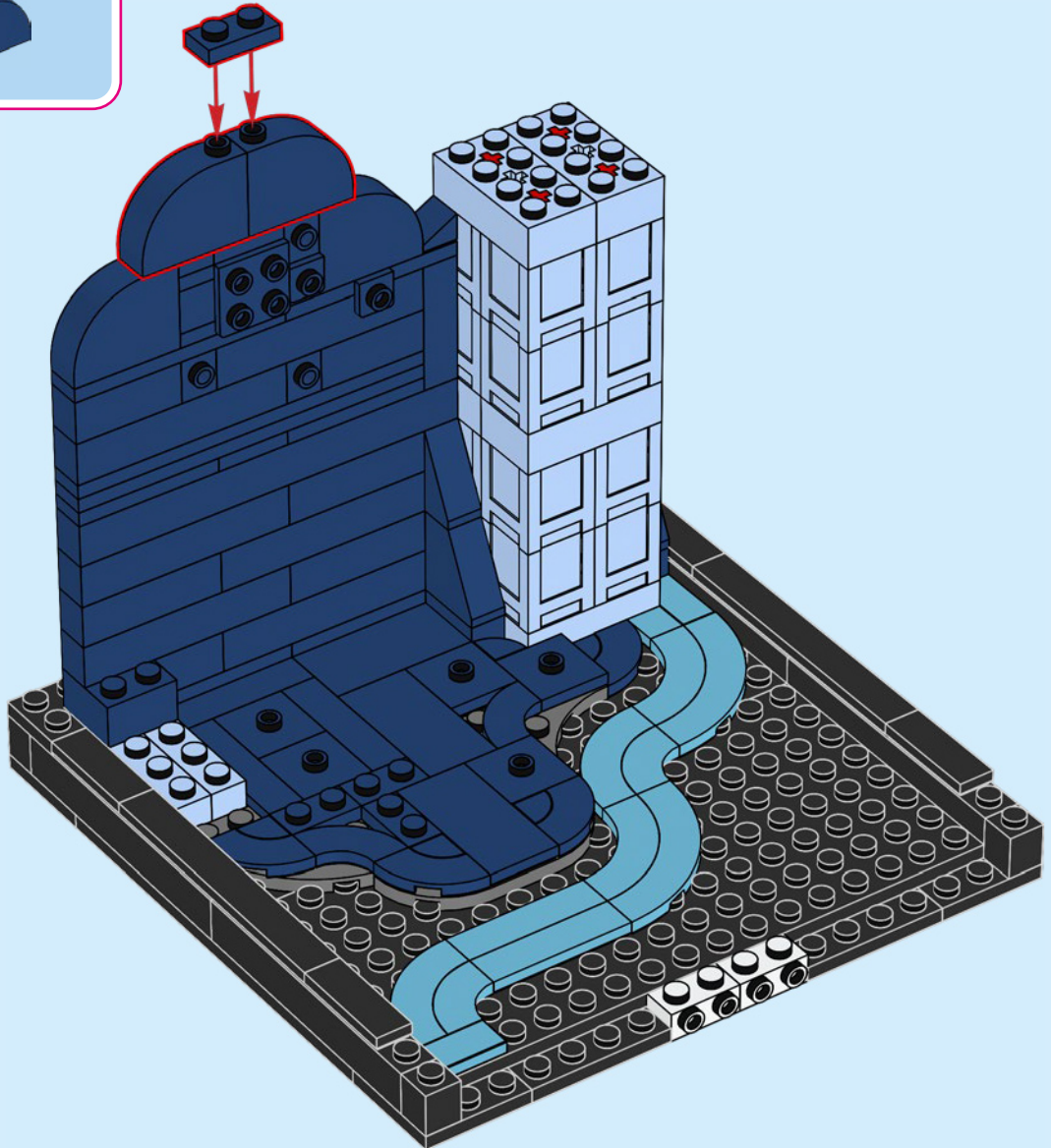

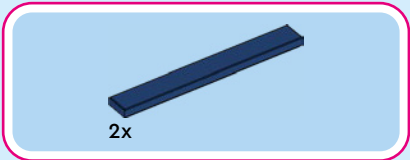

49

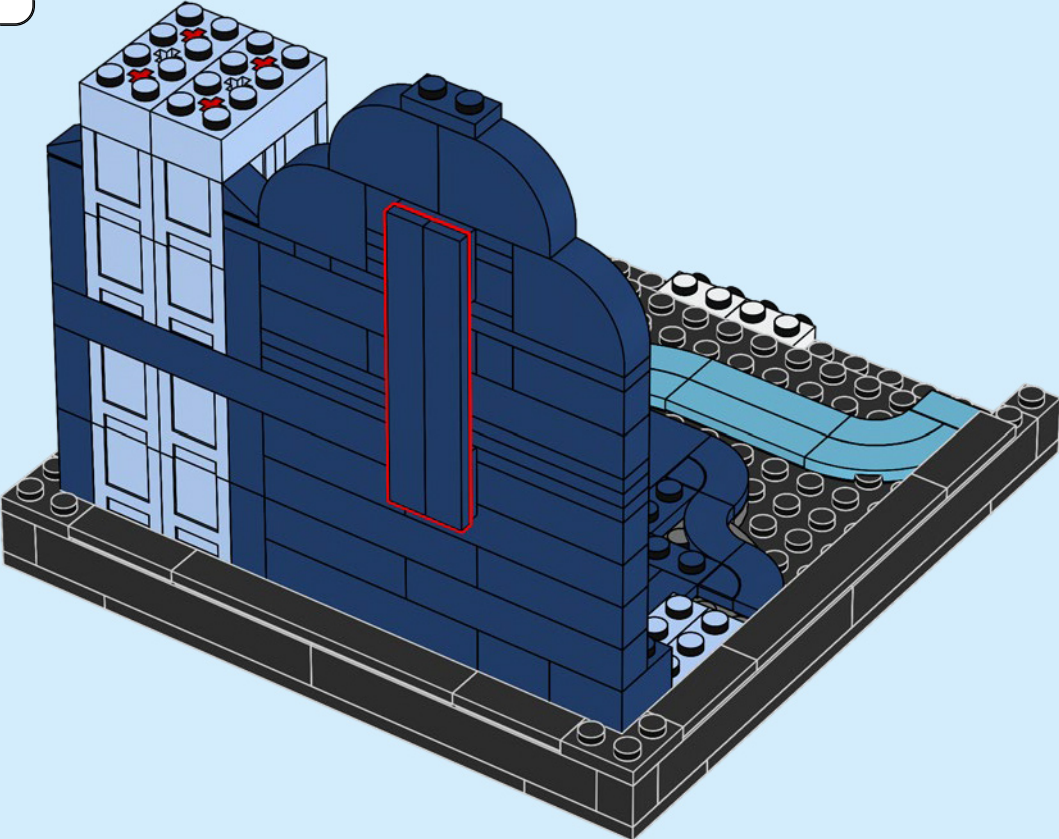



50

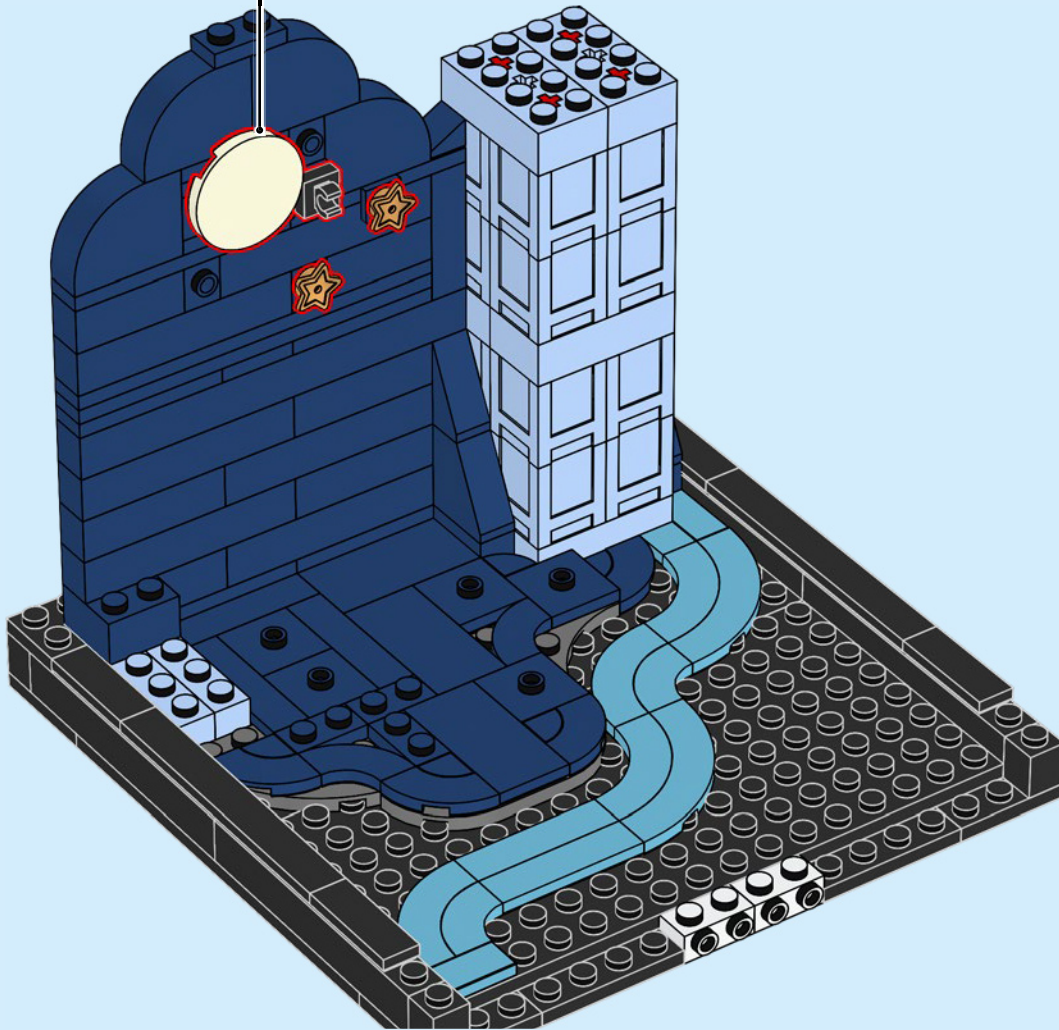

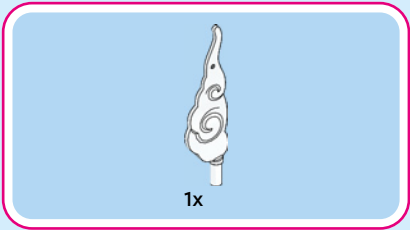

51

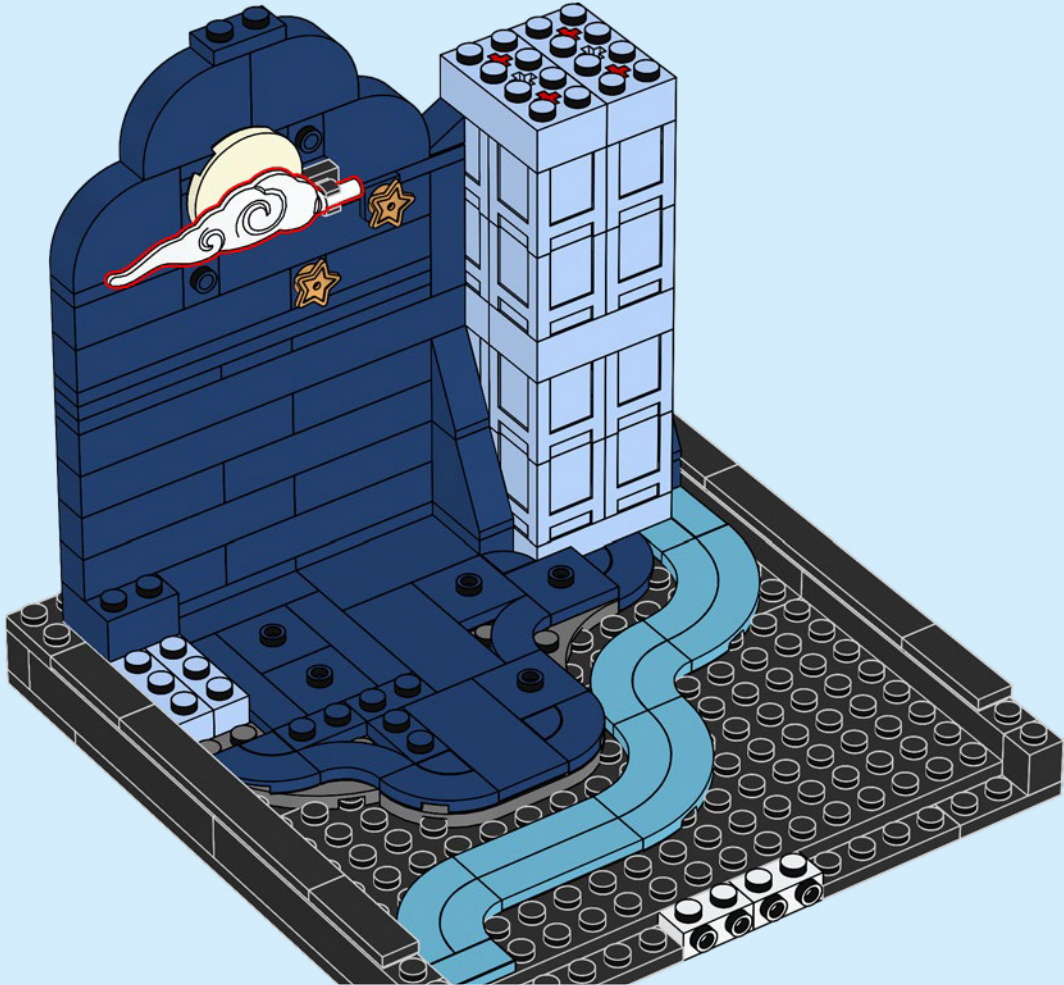

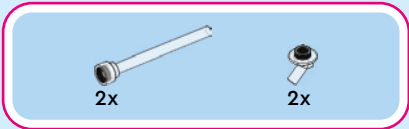

52

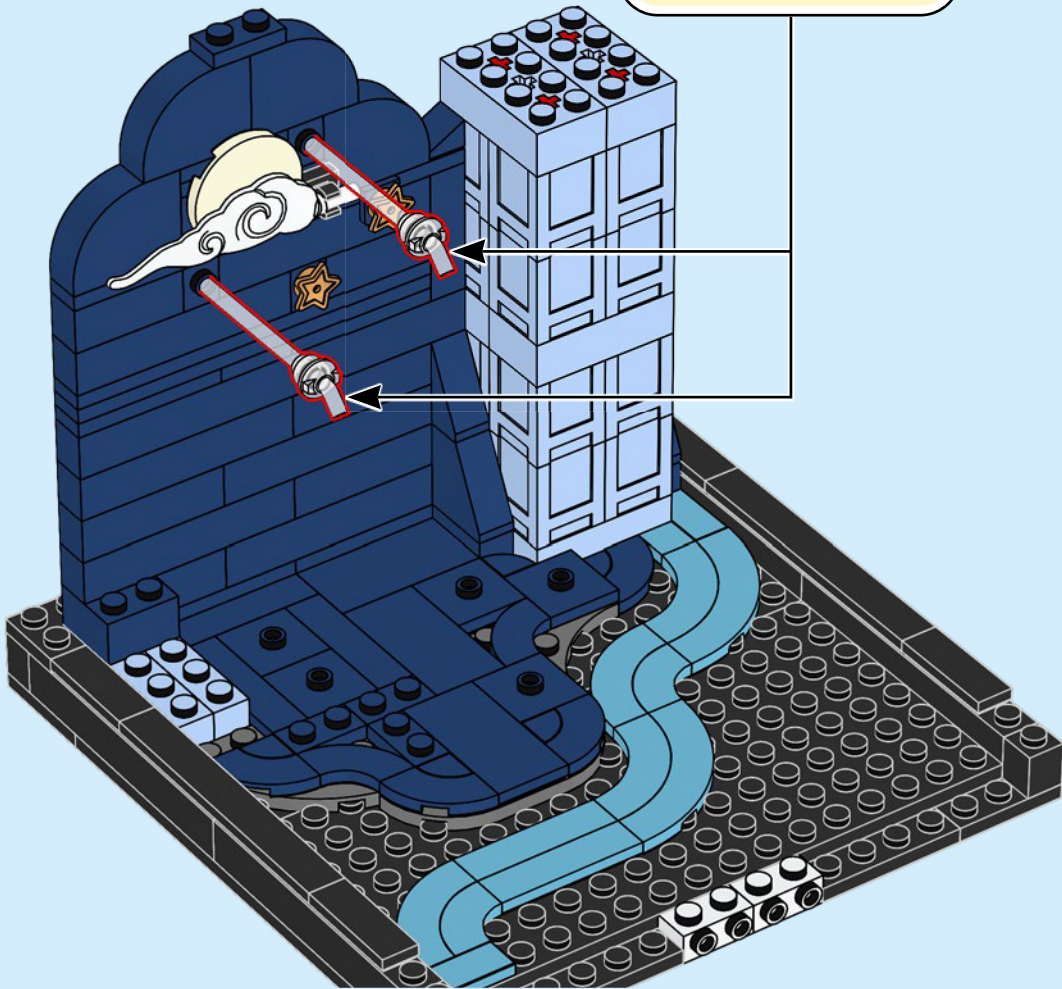
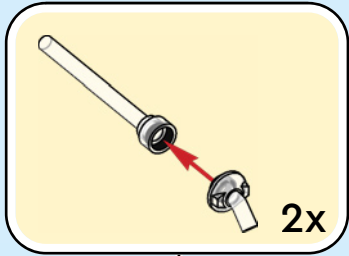

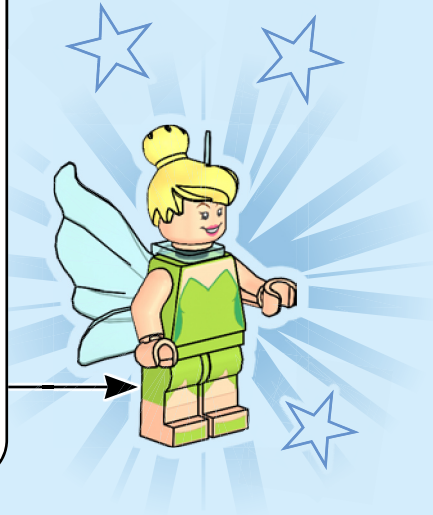
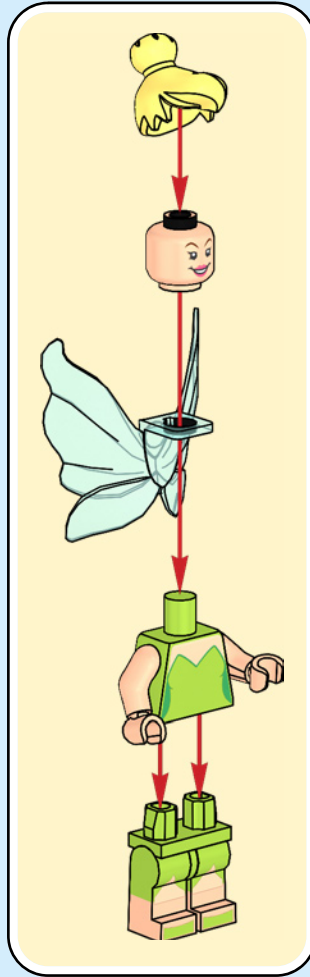





4x



4x

53

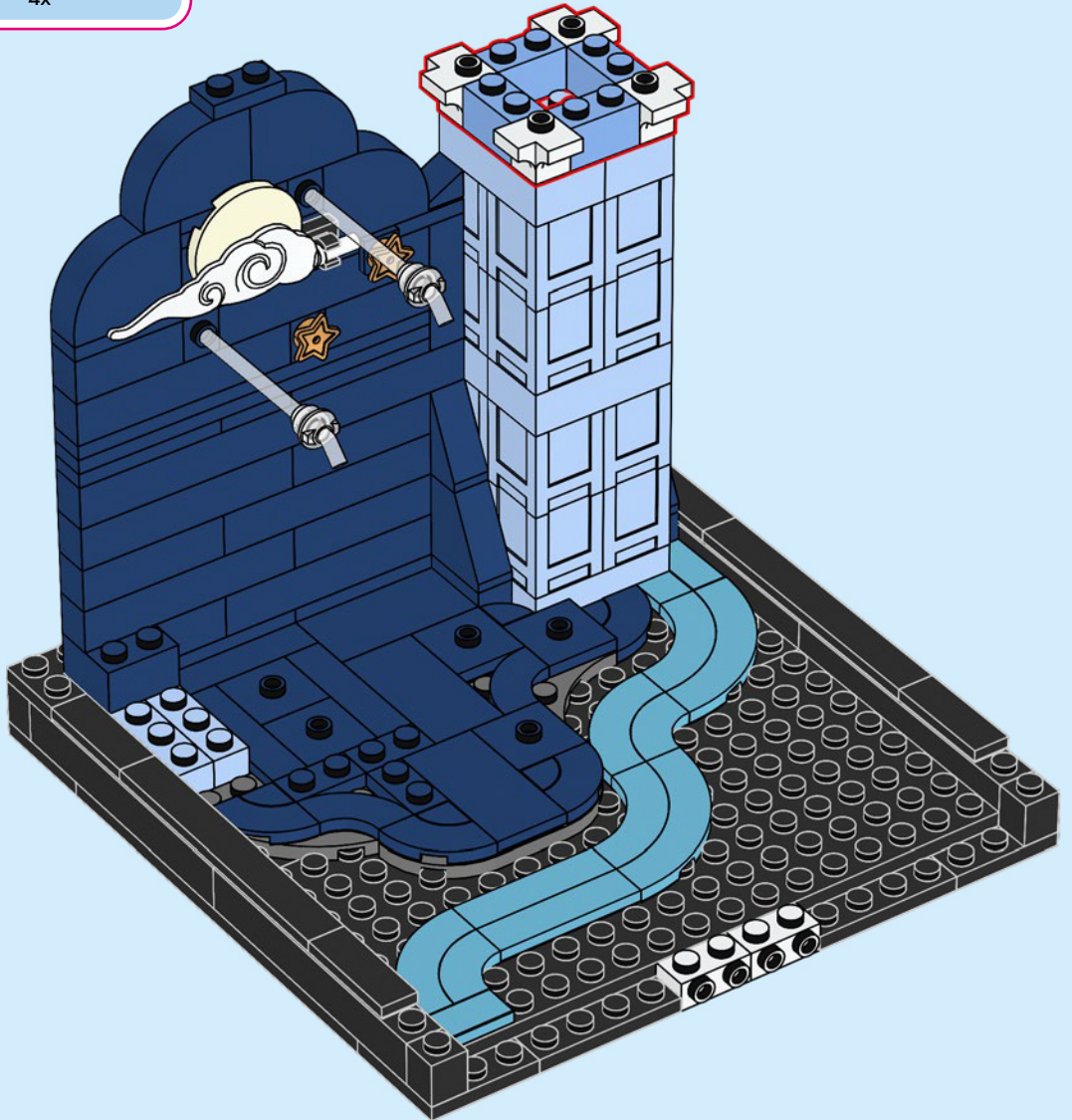

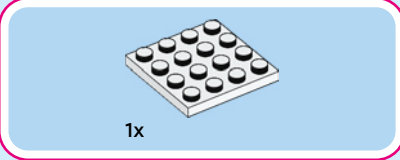
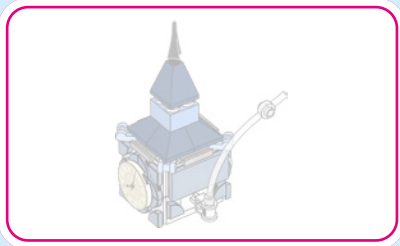

54

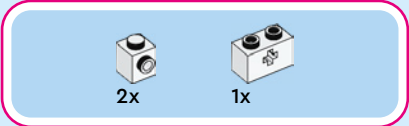
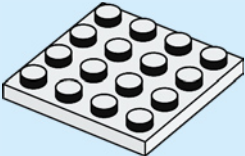

55

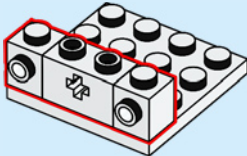



3x

56

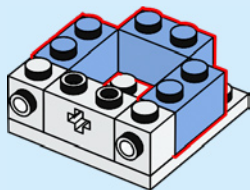

1x

57

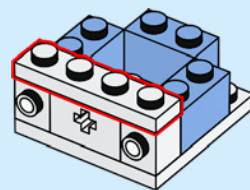

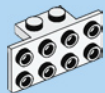

3x

58

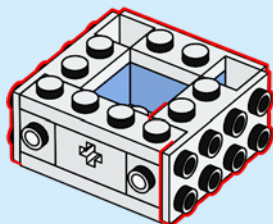

2x

59

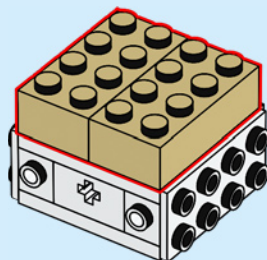

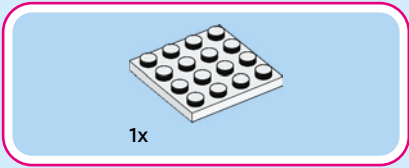

60

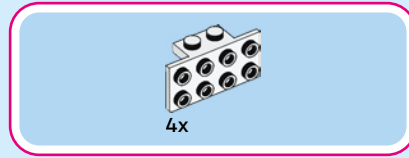
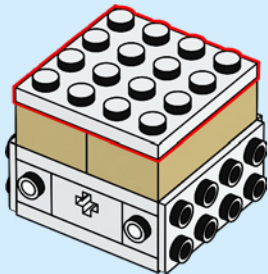

61

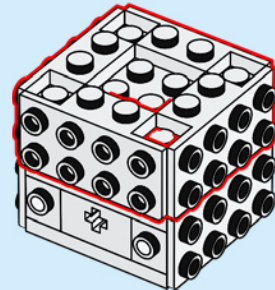



4x

62

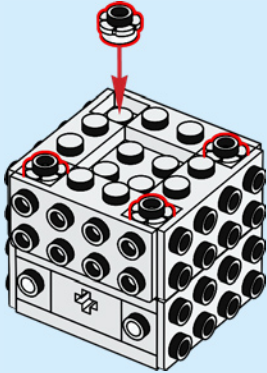

1x

63

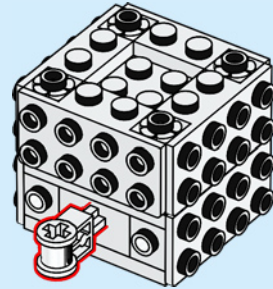

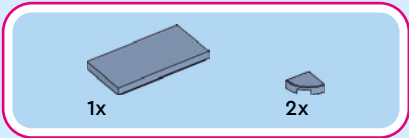

64

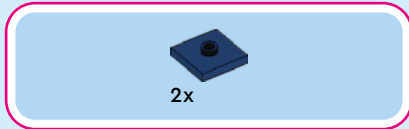
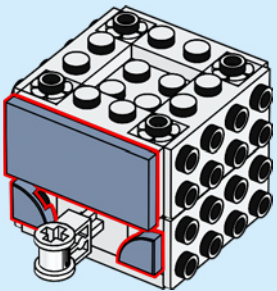

65

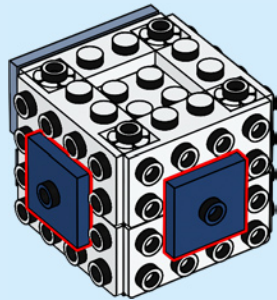

16x

66

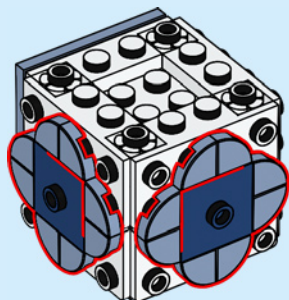

8x

67

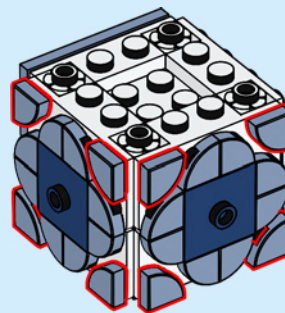





2x

68

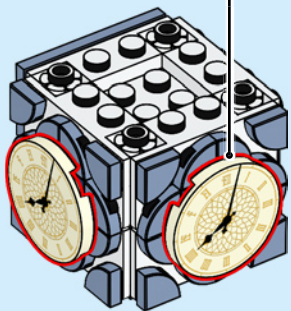

1x

69

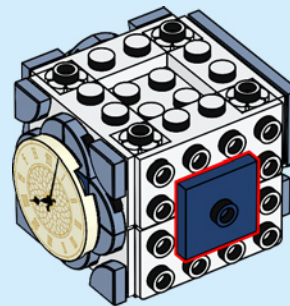
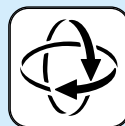



70

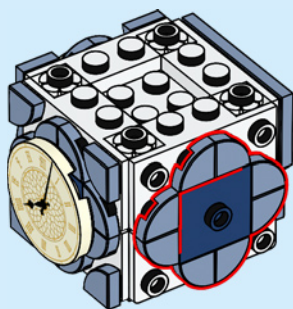

71

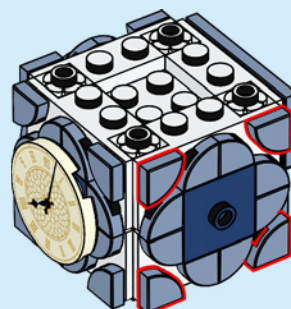



1x

72

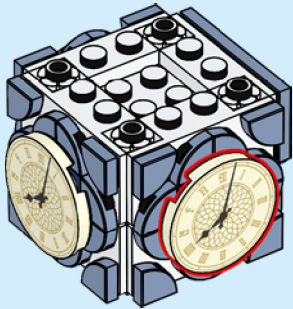

4x

73

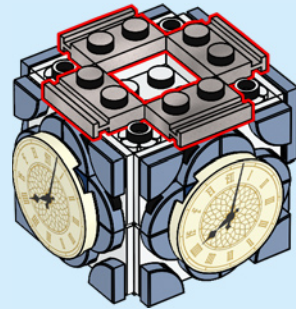



74

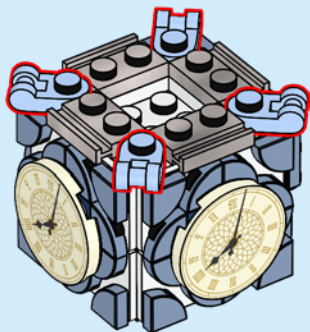

75

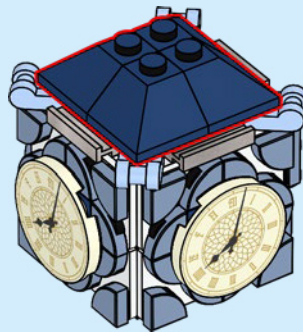



1x

76

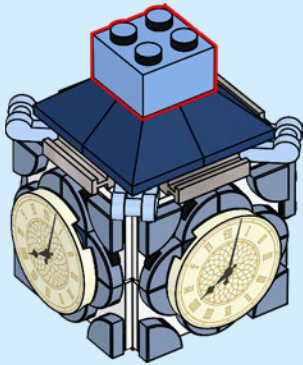

4x

77

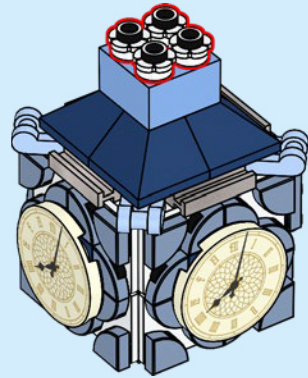



78

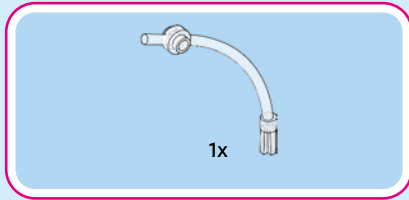
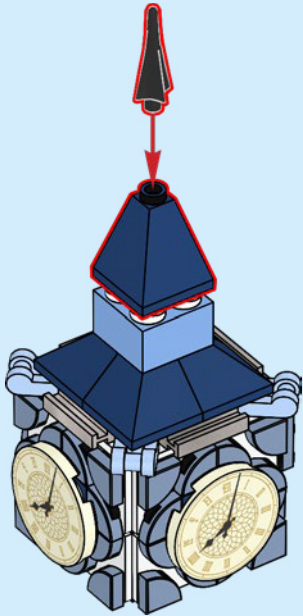

79

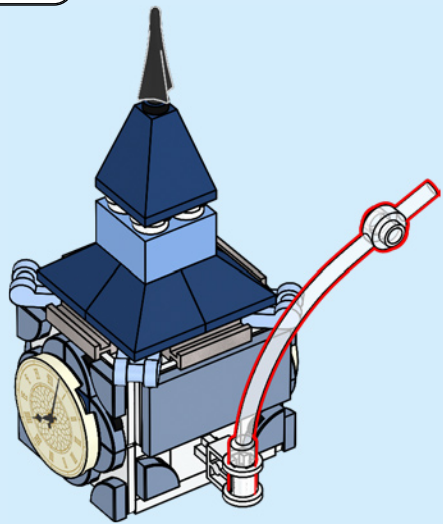

80

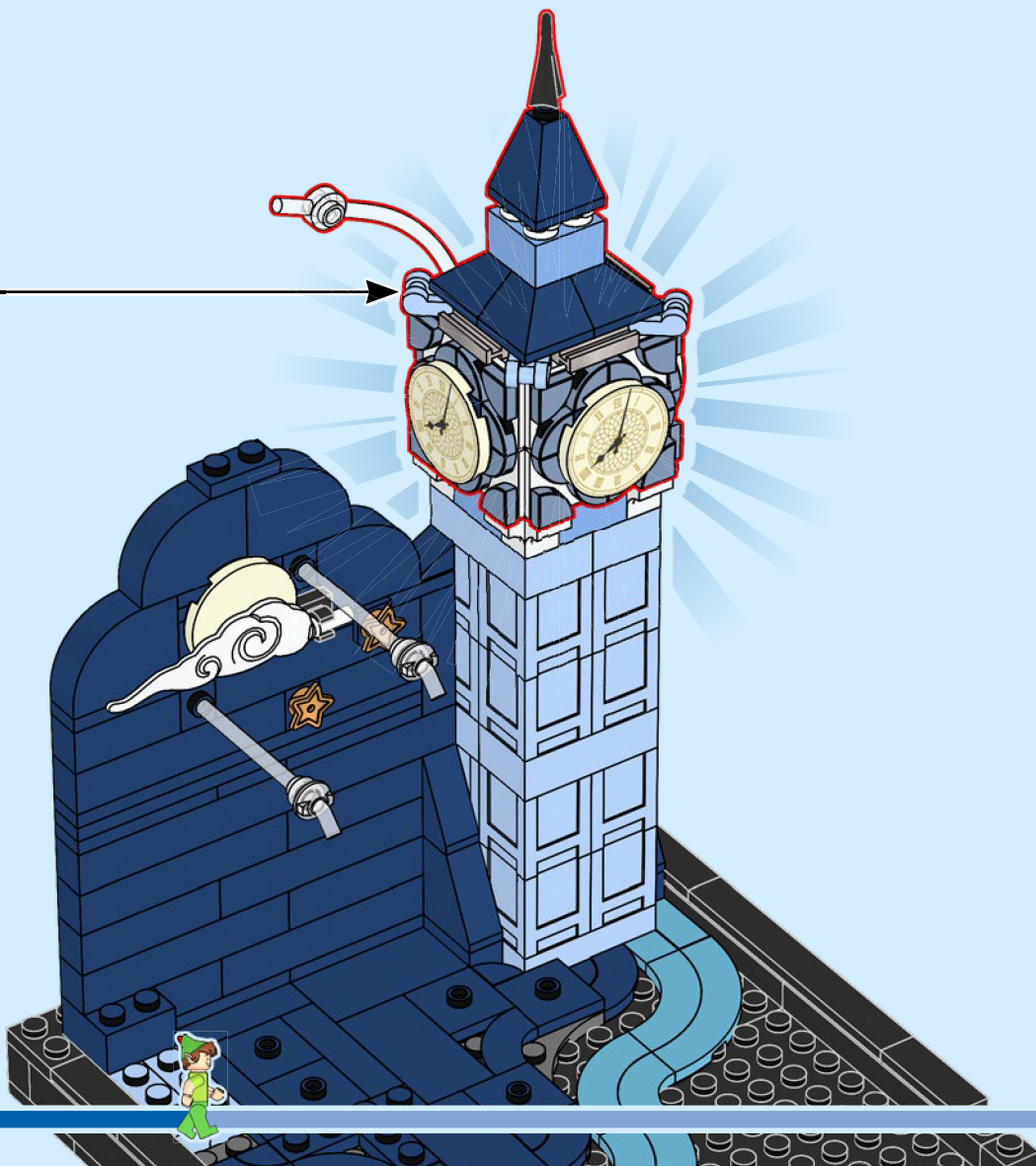

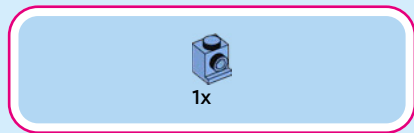

81

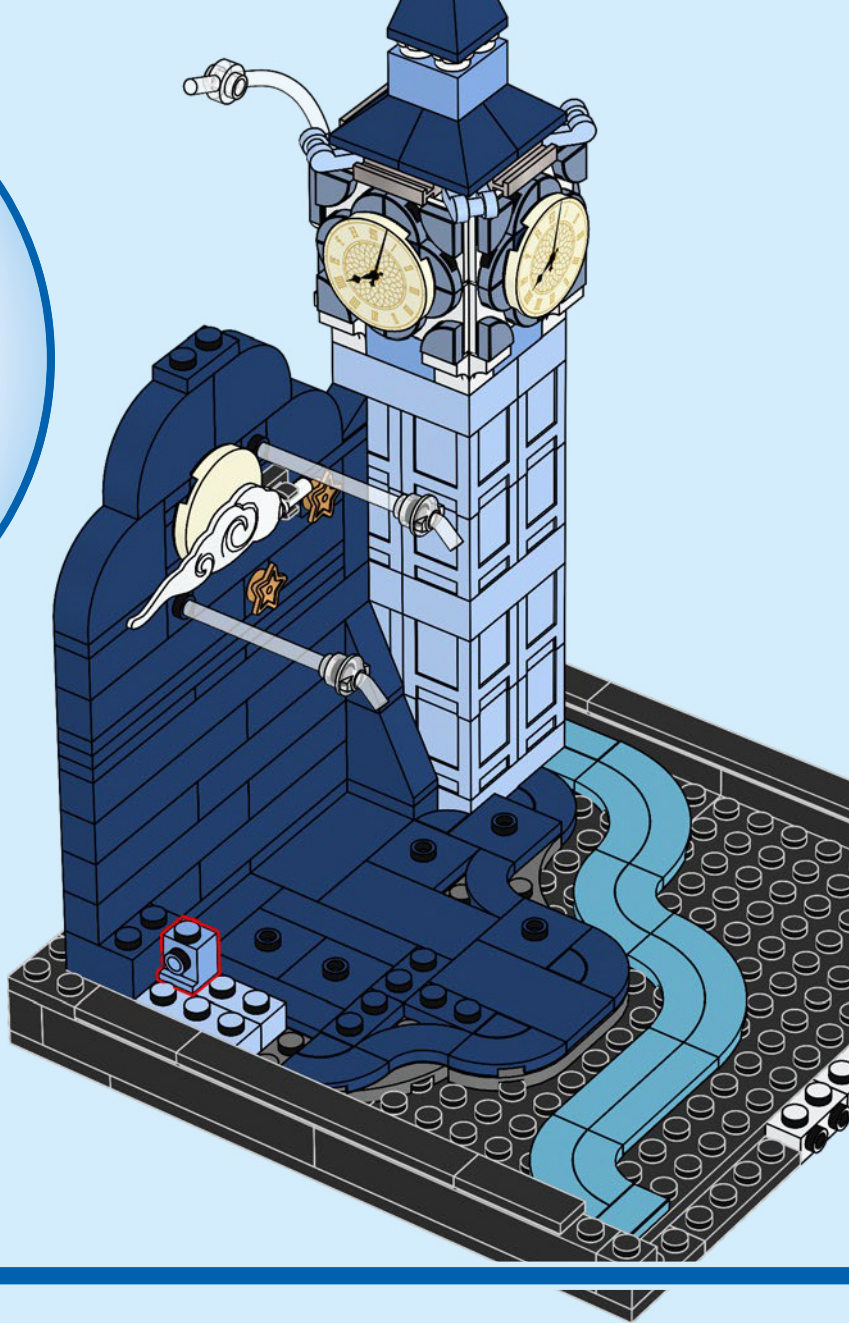



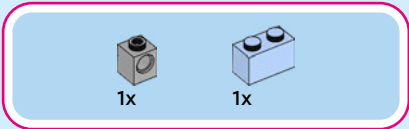

82

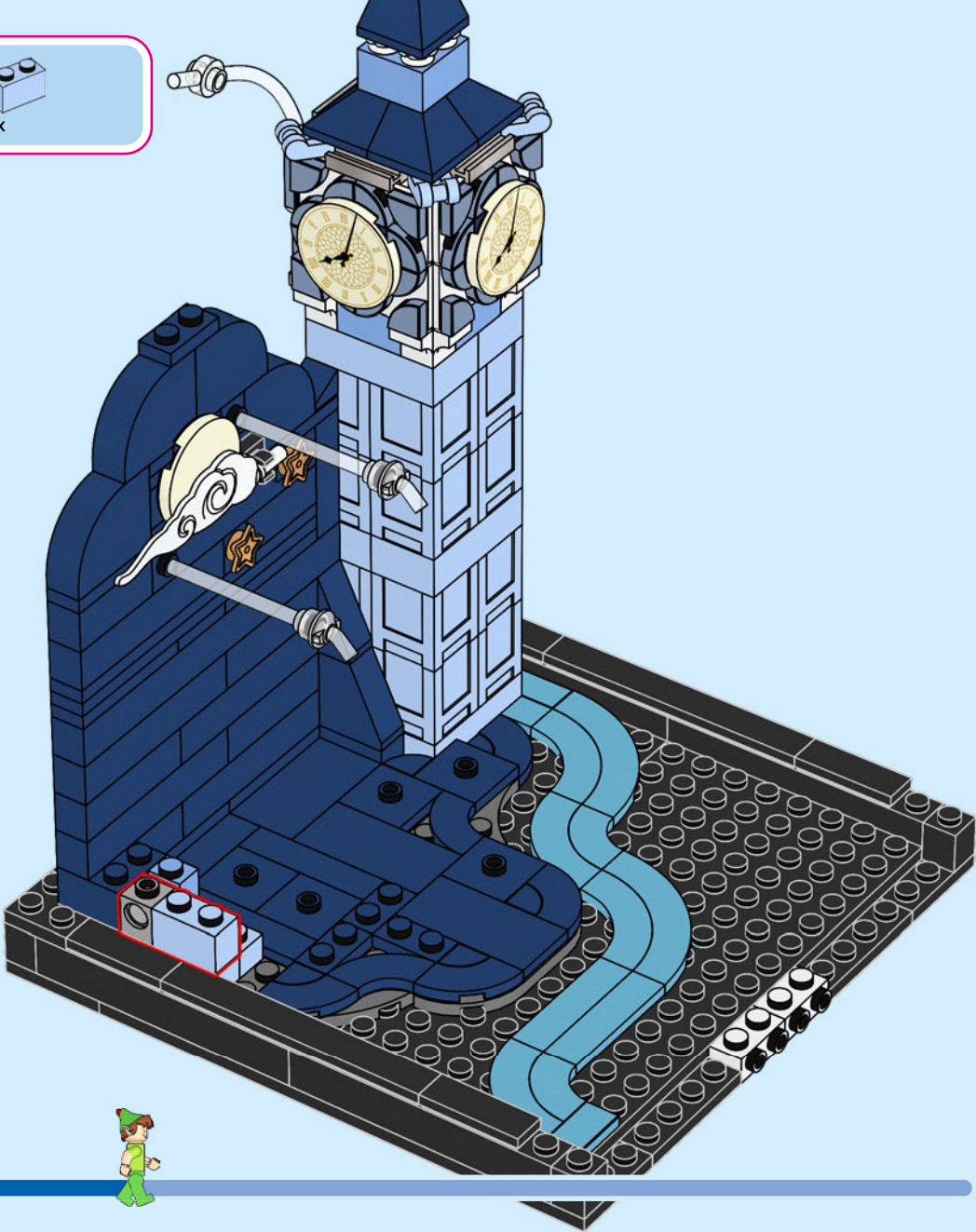

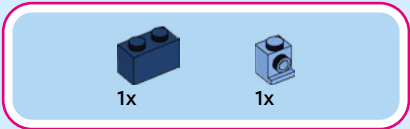

83

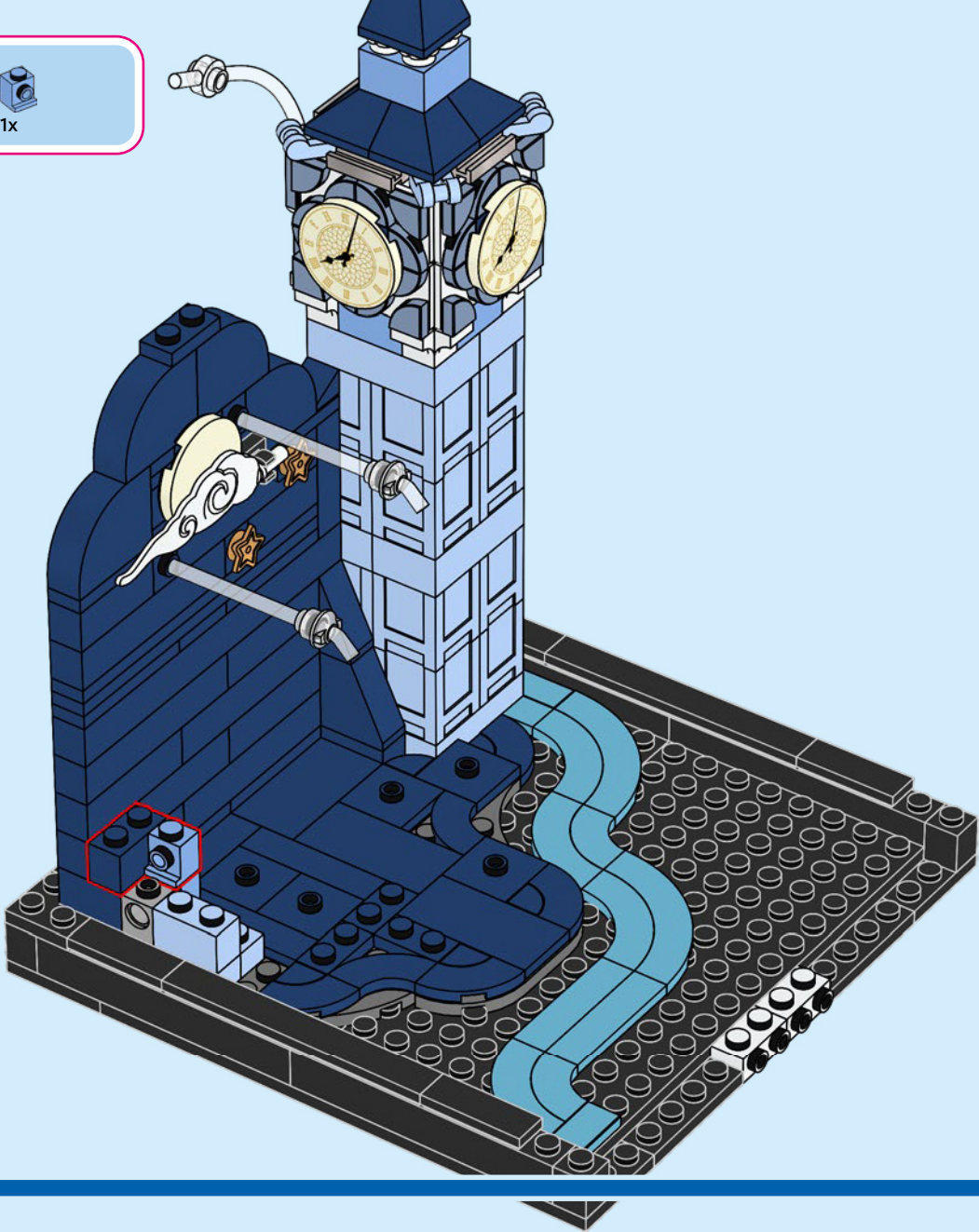

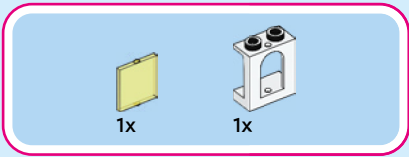

84

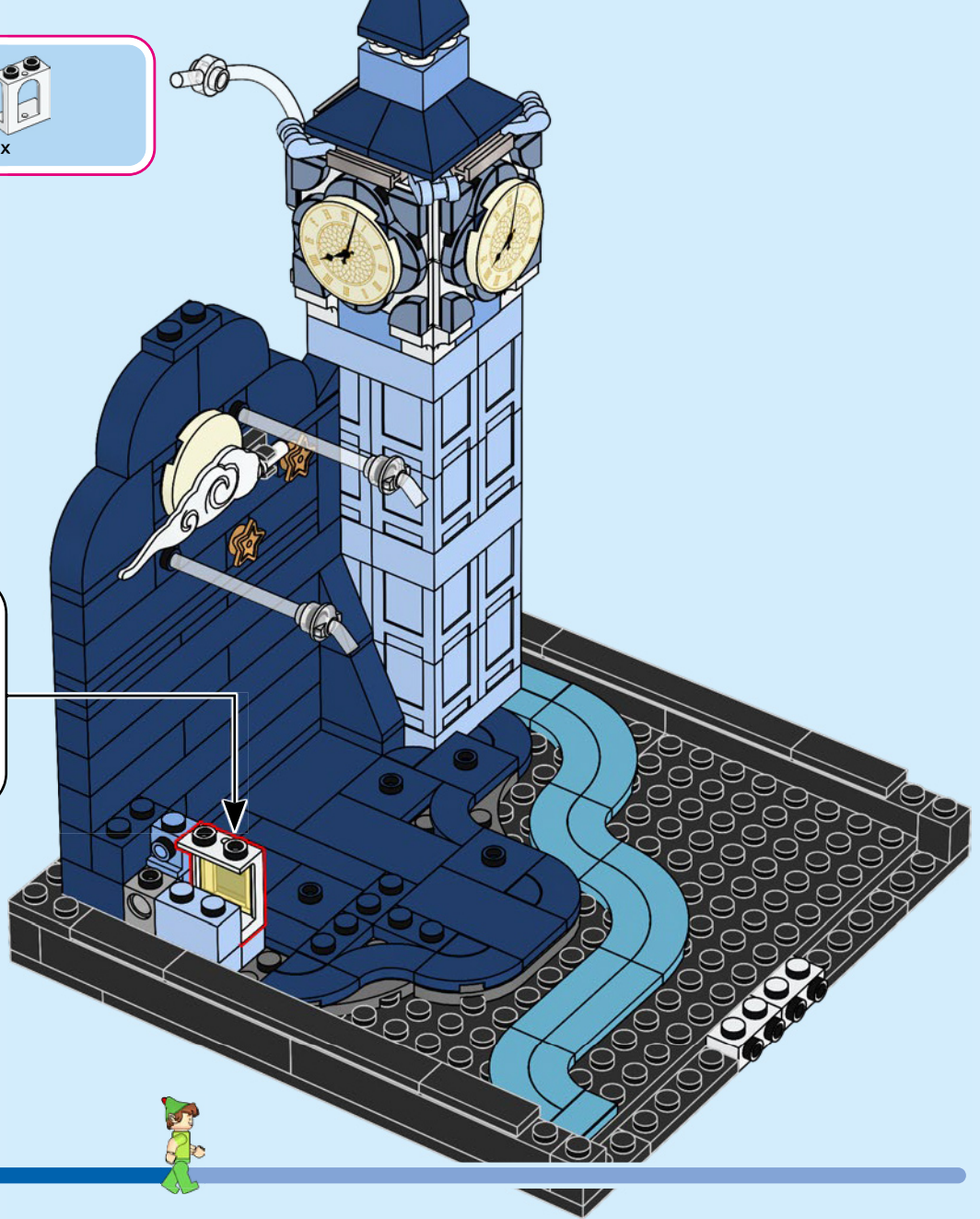
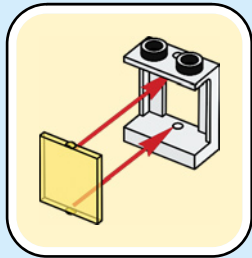



1x



1x

85

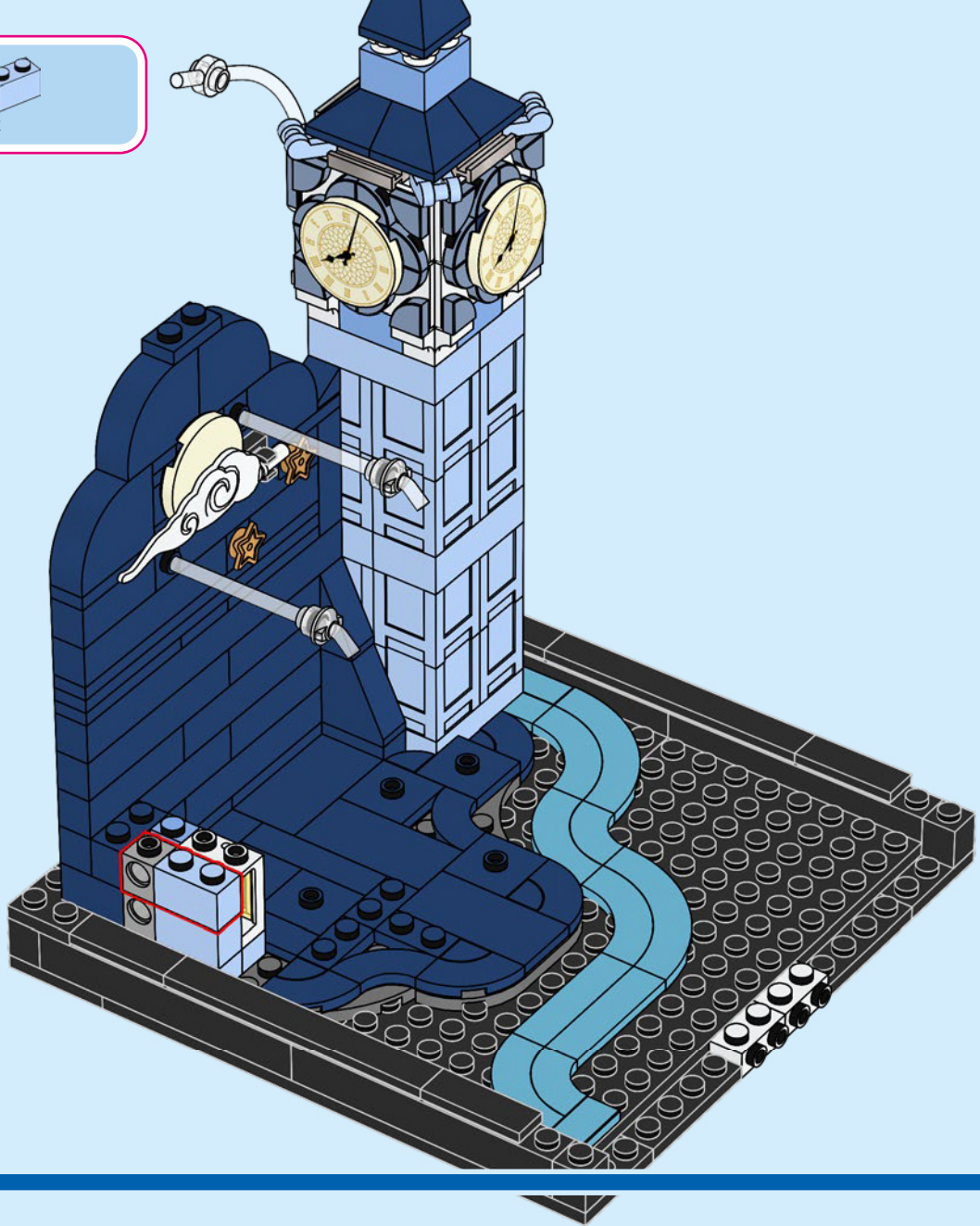

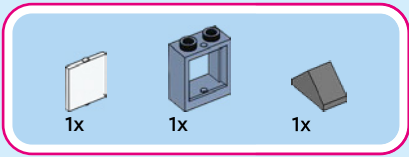

86

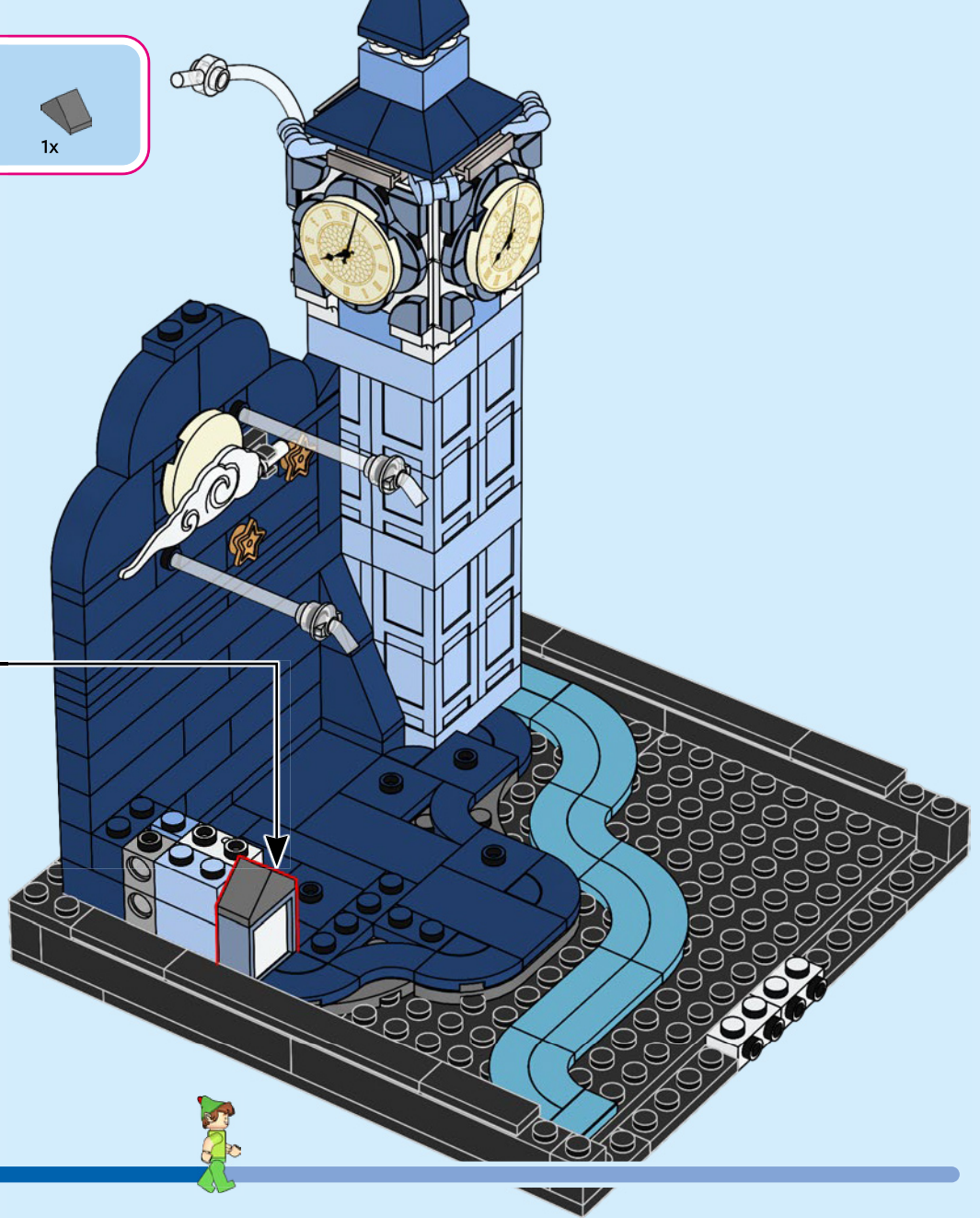
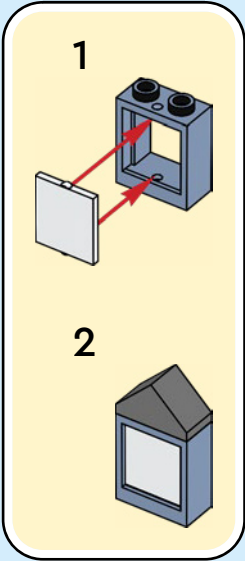

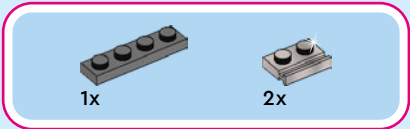

87

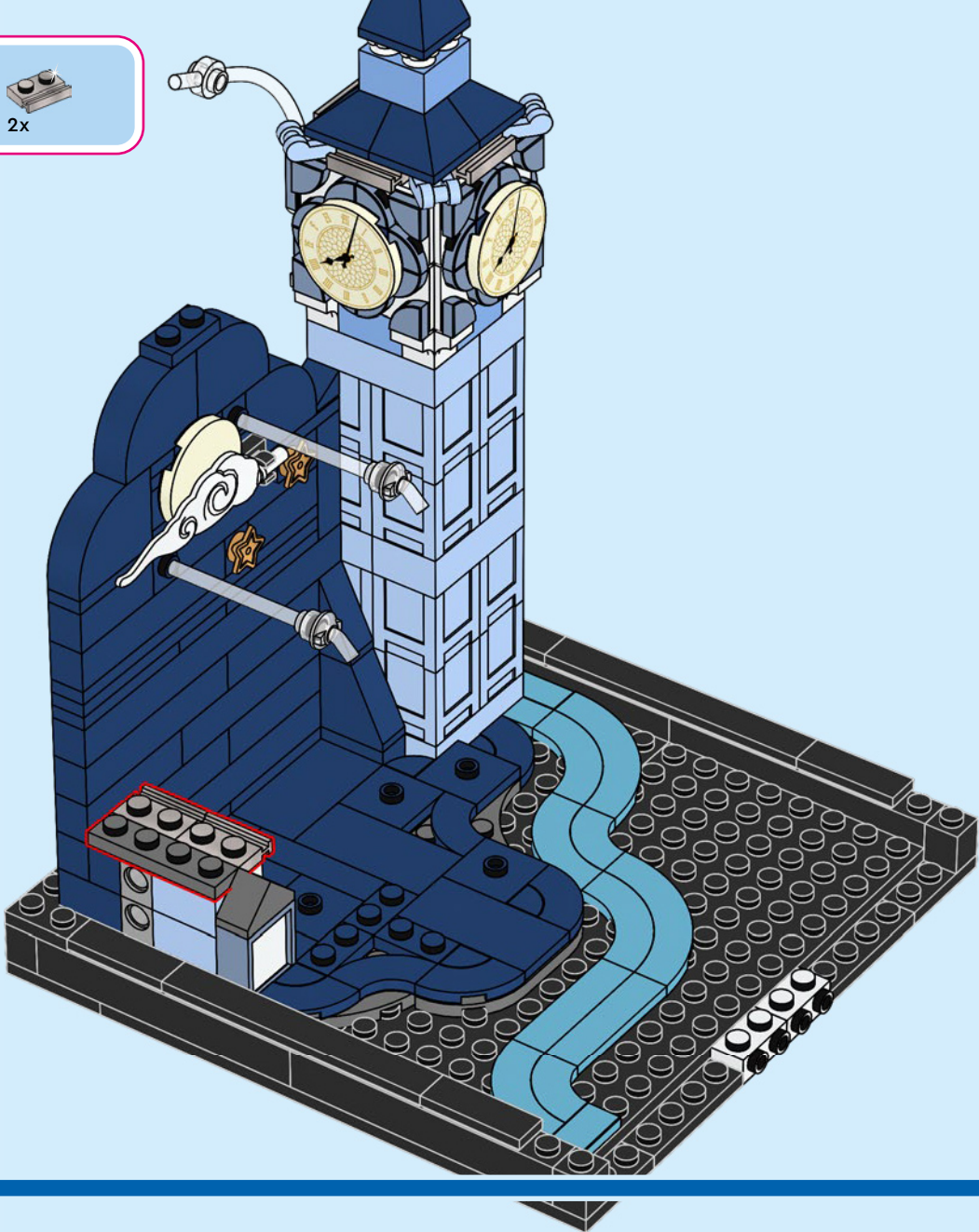

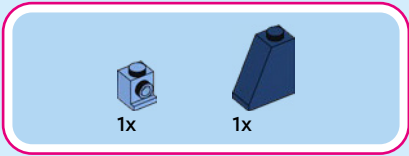

88

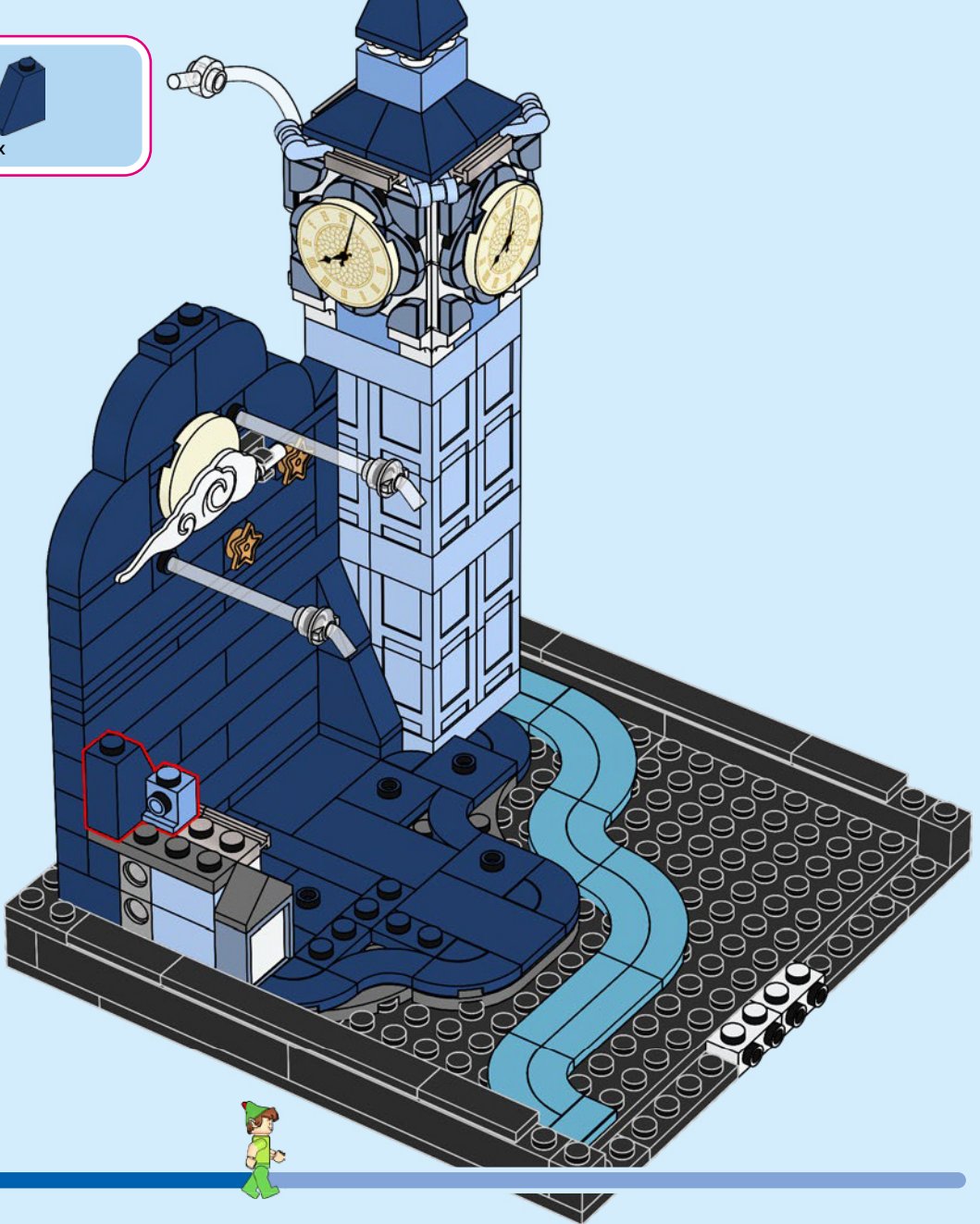



1x



1x

89

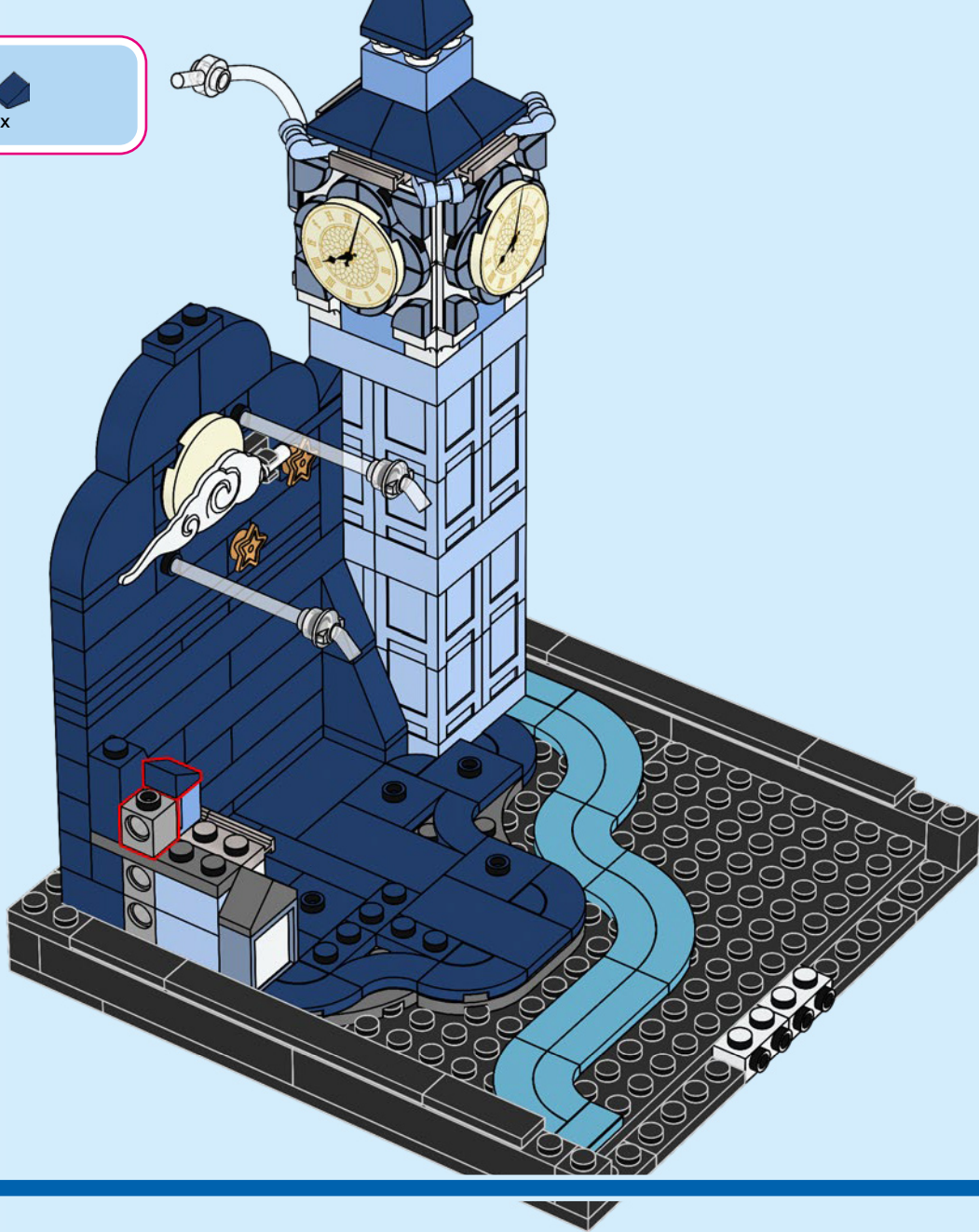



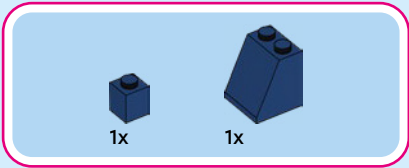

90

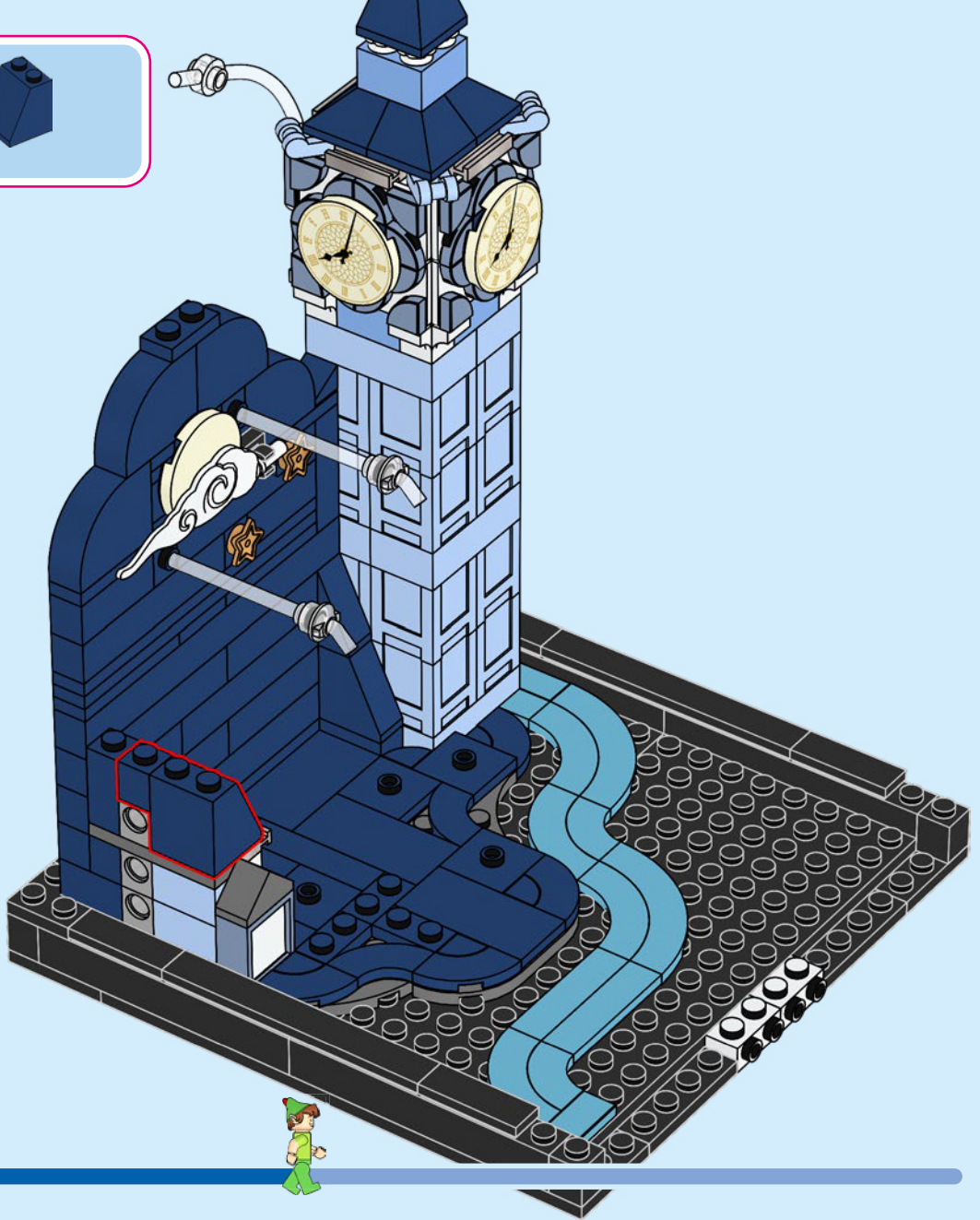

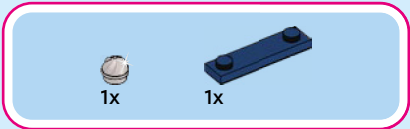

91

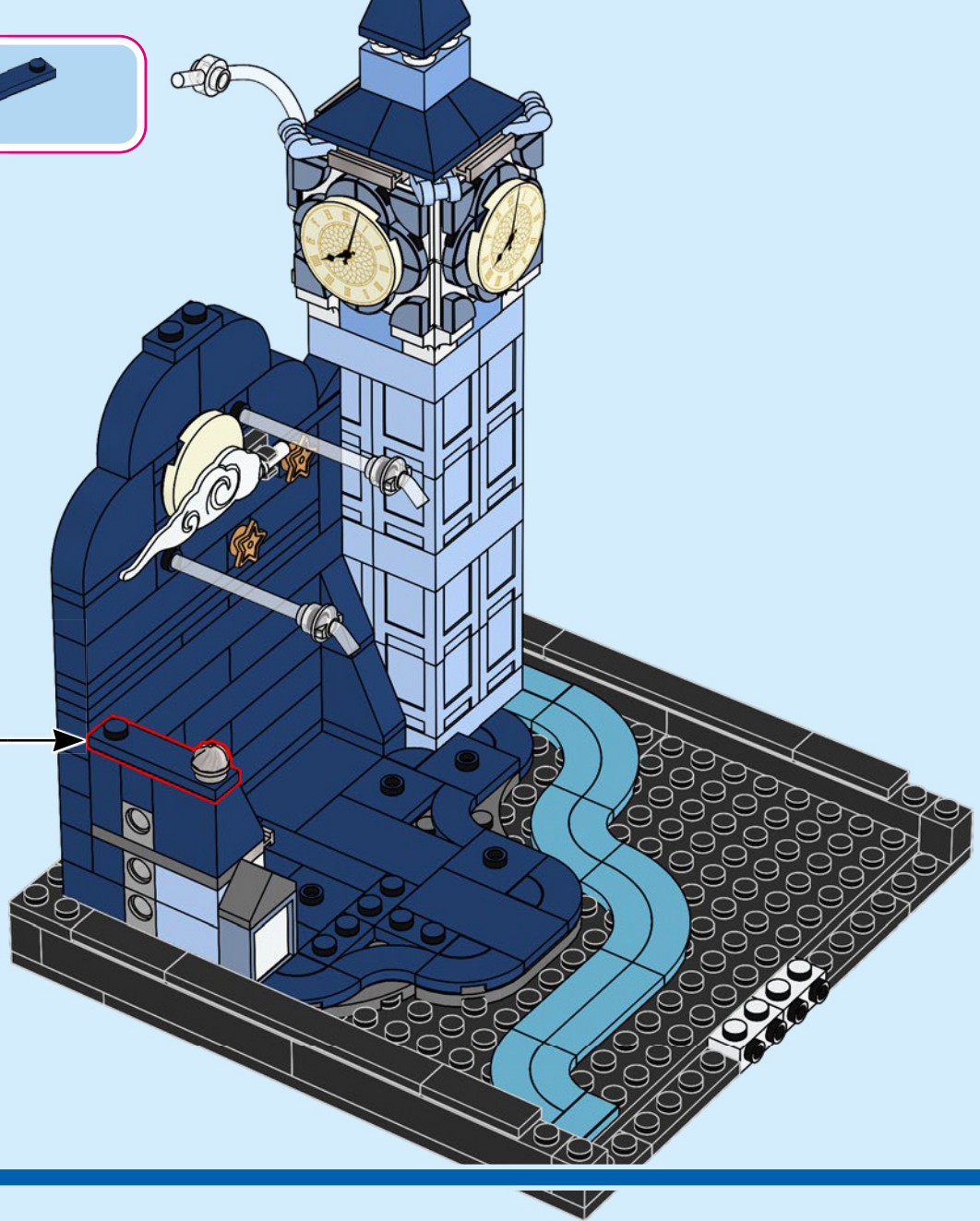
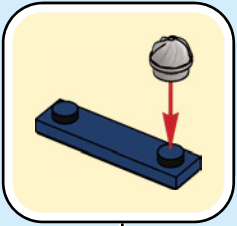



92

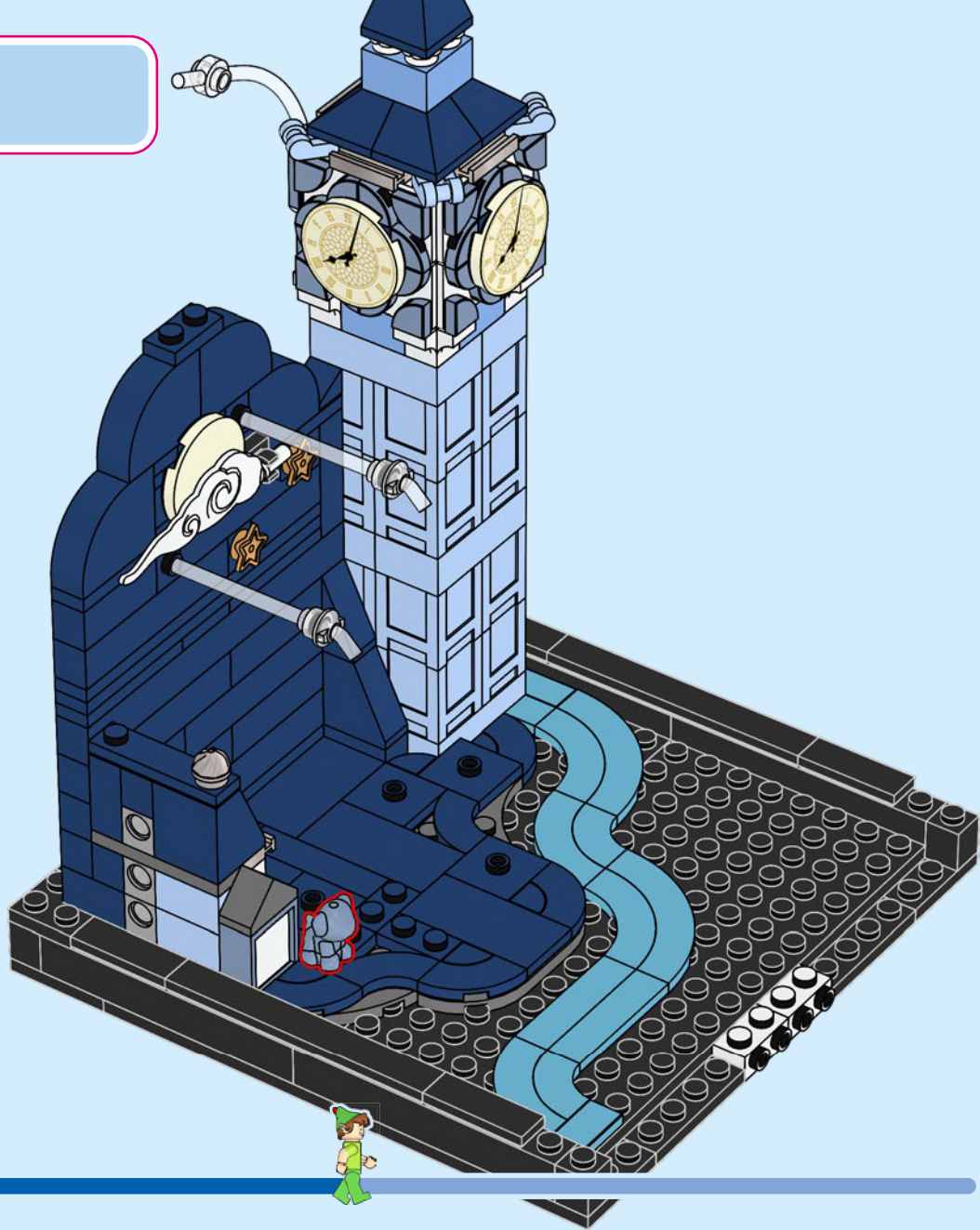

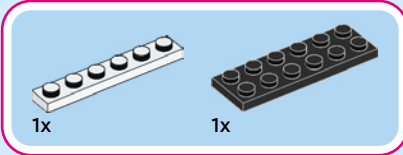
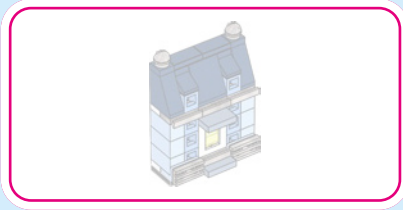

93

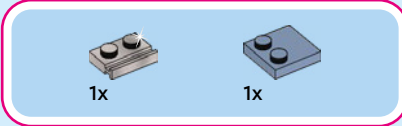
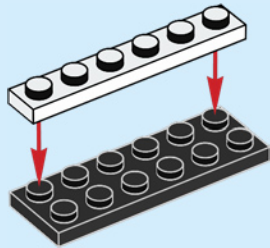

94

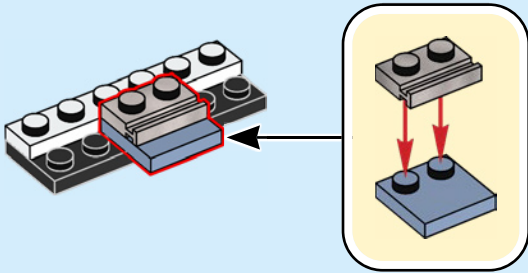



2x



2x

# 95

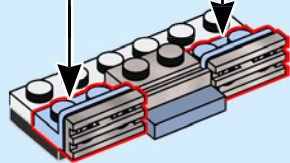
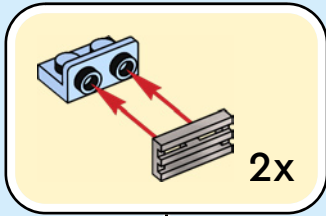

1x



1x

# 96

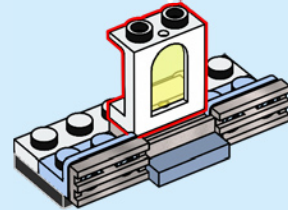
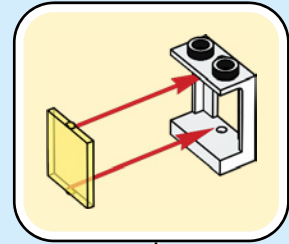

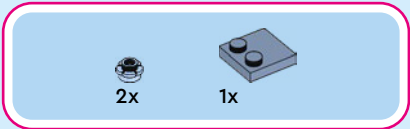

97

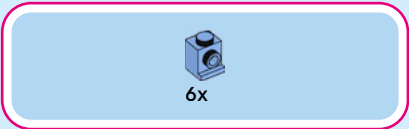
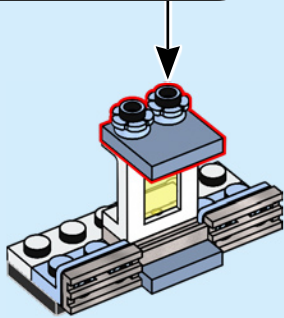
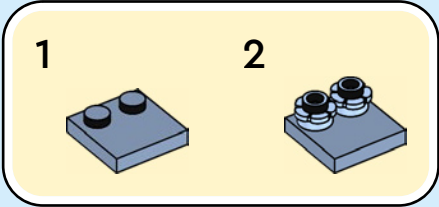

98

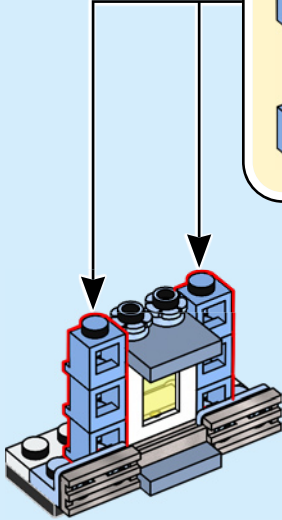
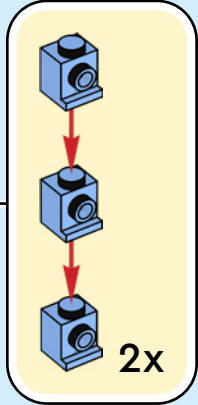

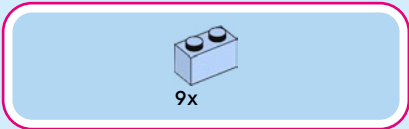

99

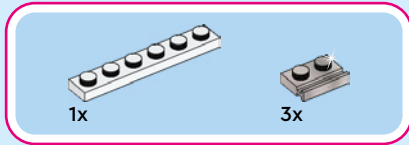
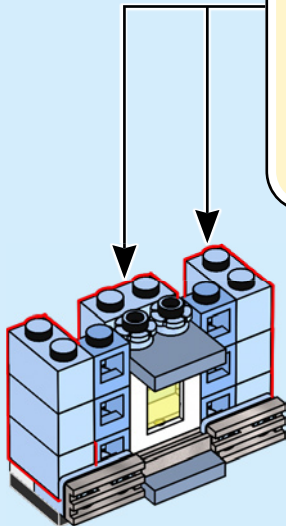
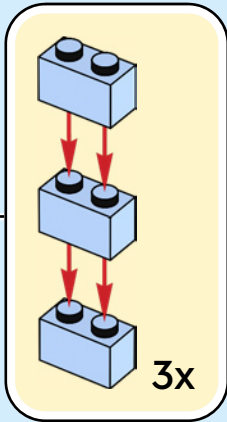

100

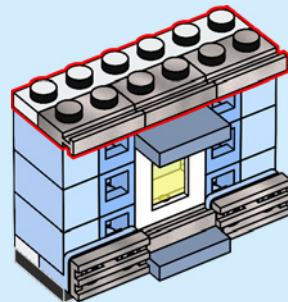



2x



1x

# 101

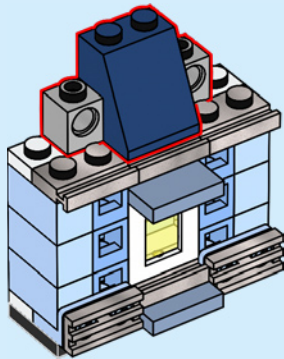

2x



2x

# 102

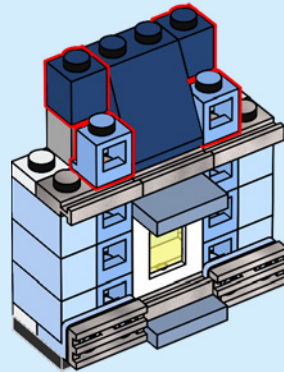





103

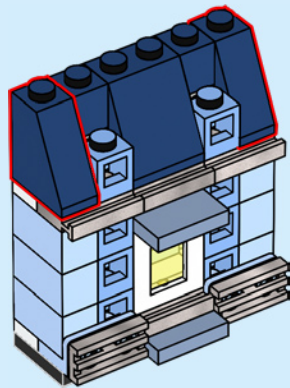

104

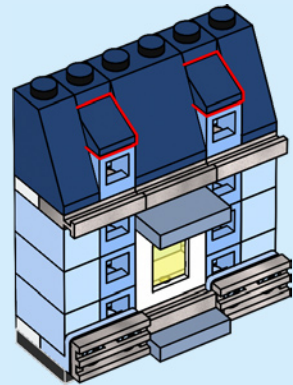



2x



2x

# 105

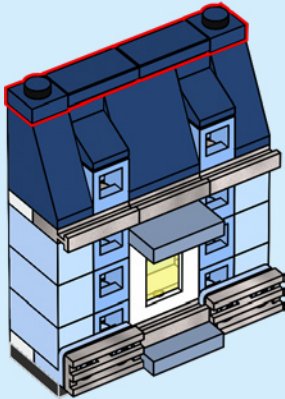

2x

# 106

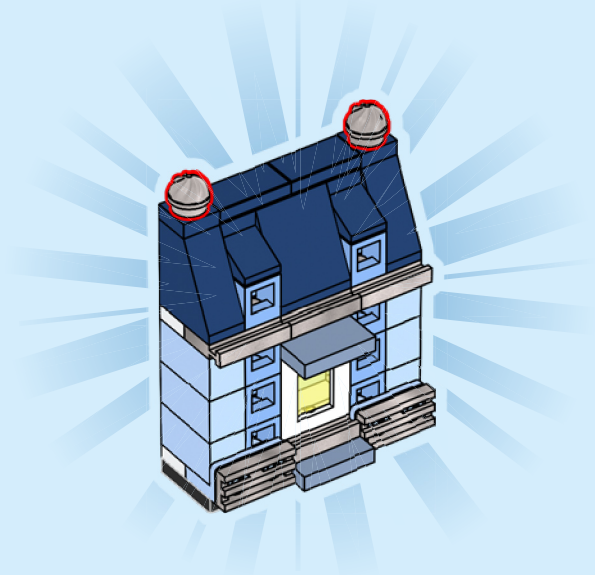

107

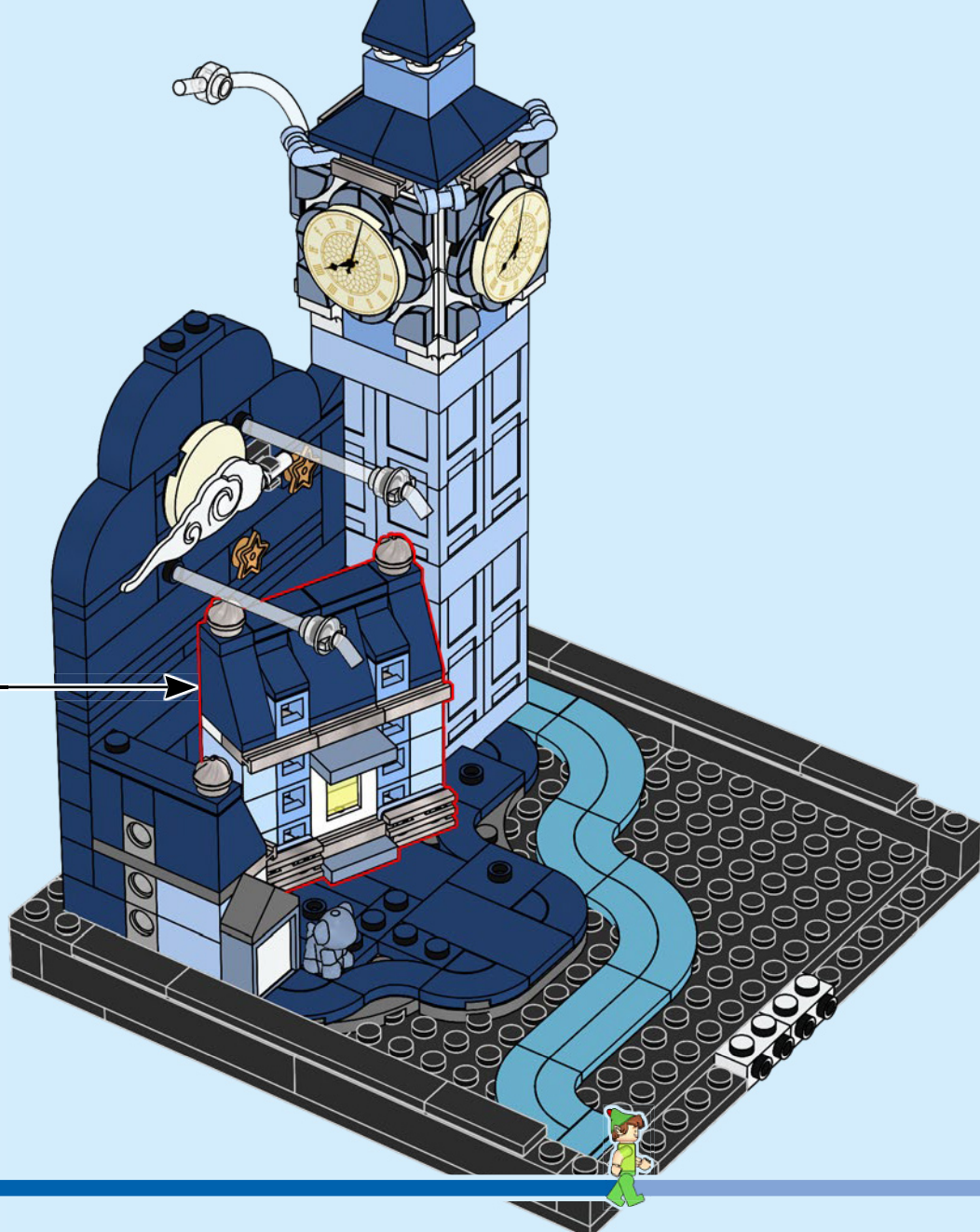

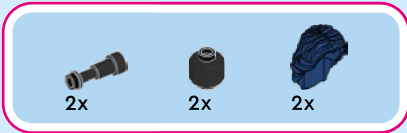

108

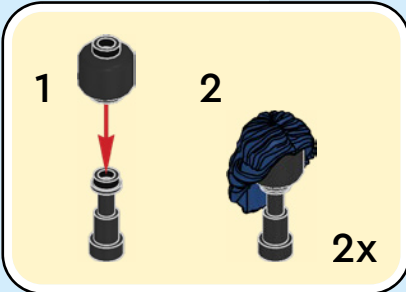
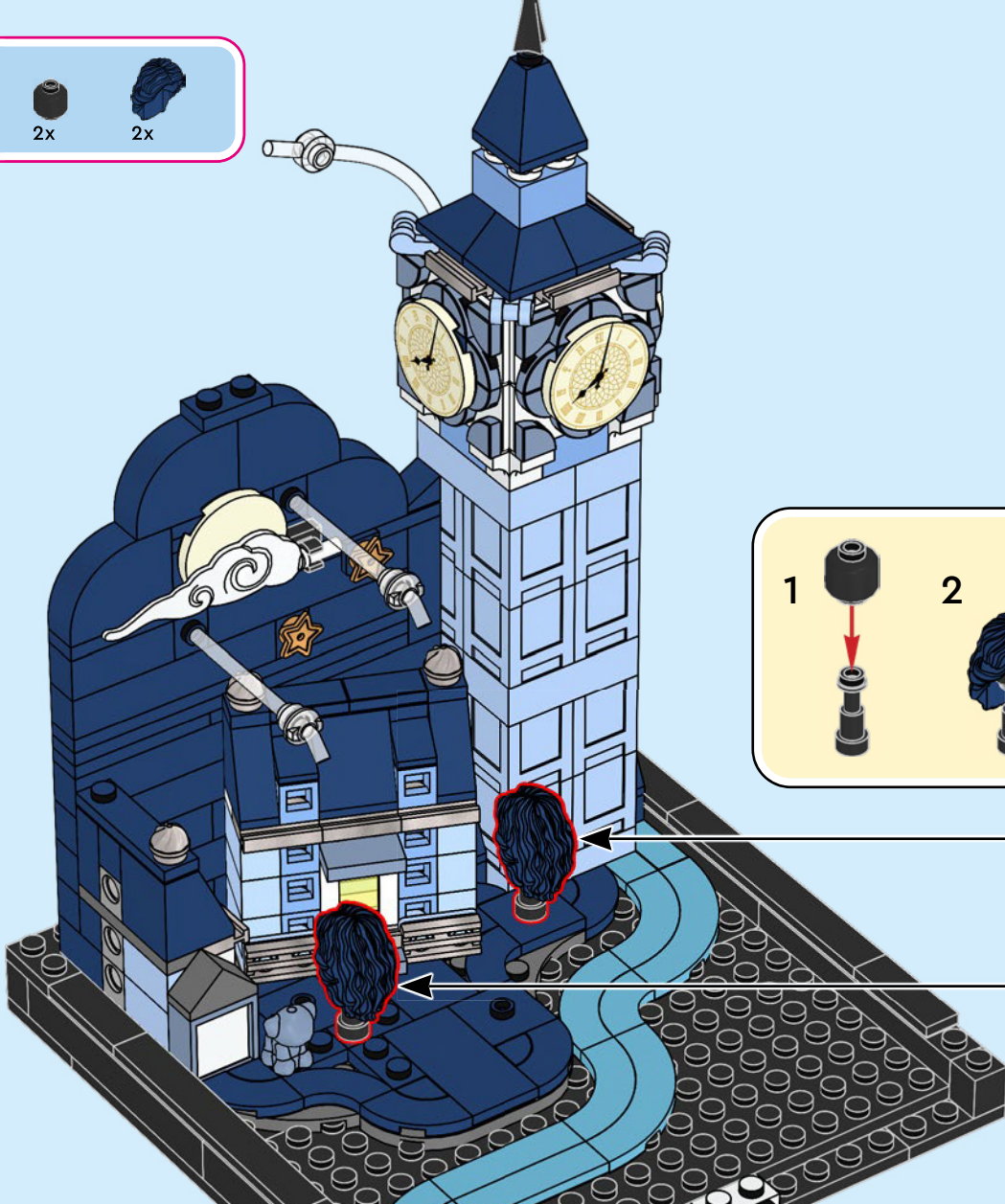



109

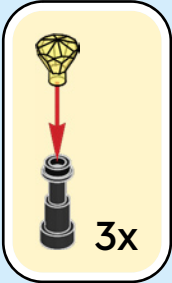

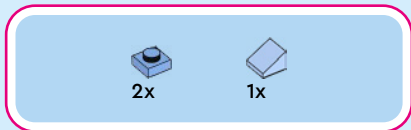

110





1x



1x

111

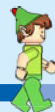
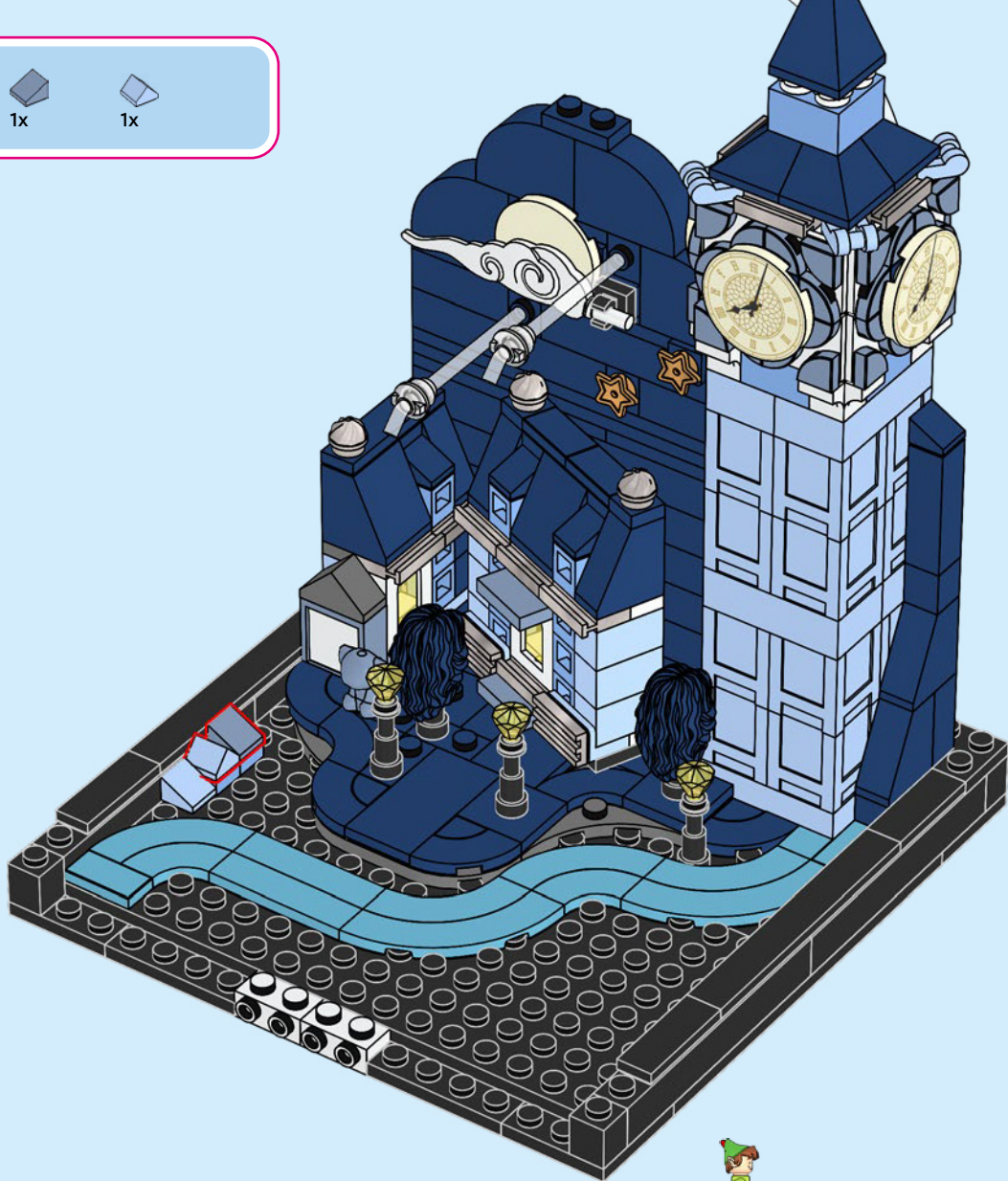



1x



1x

112

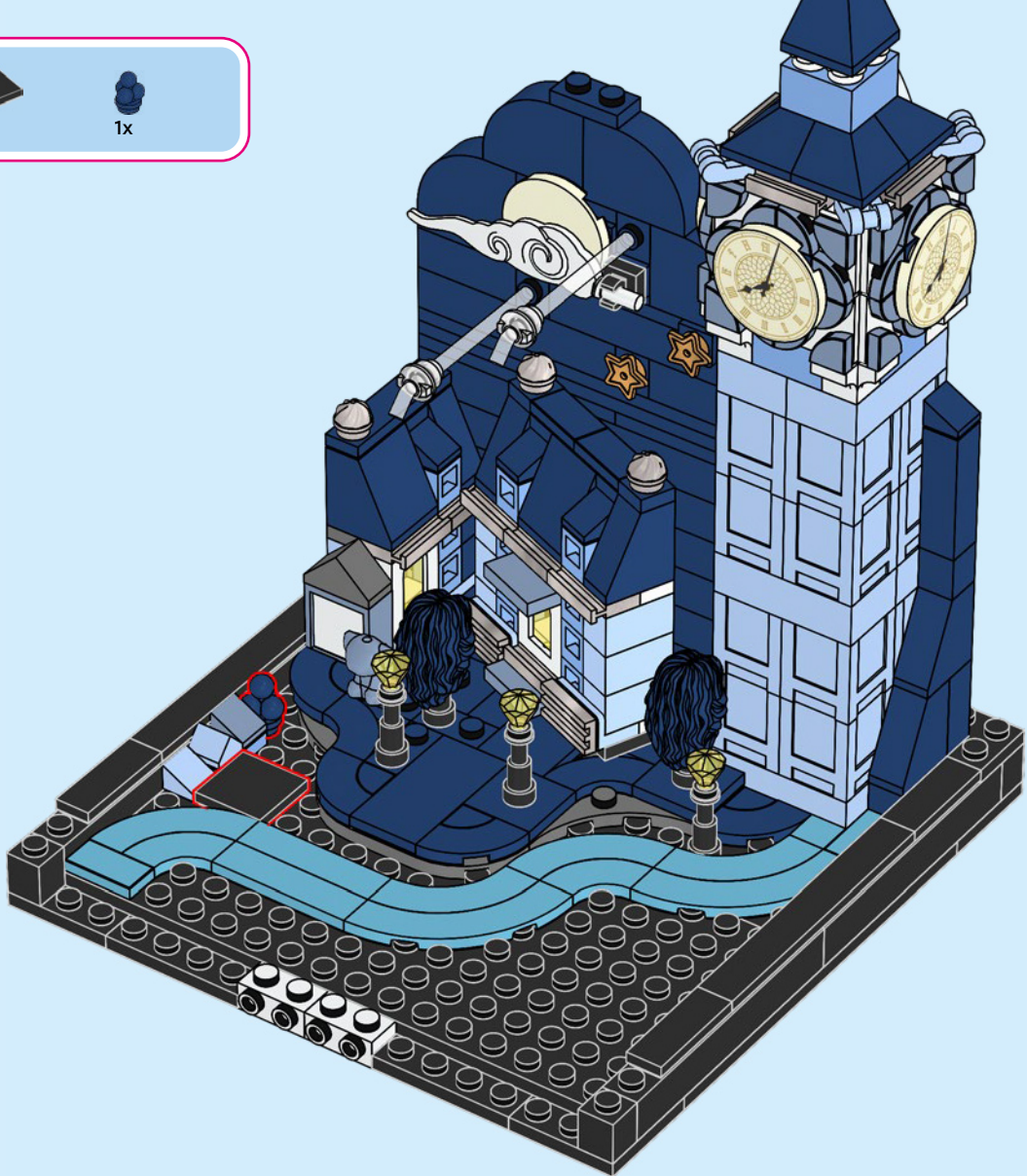



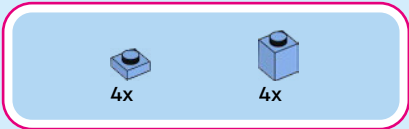



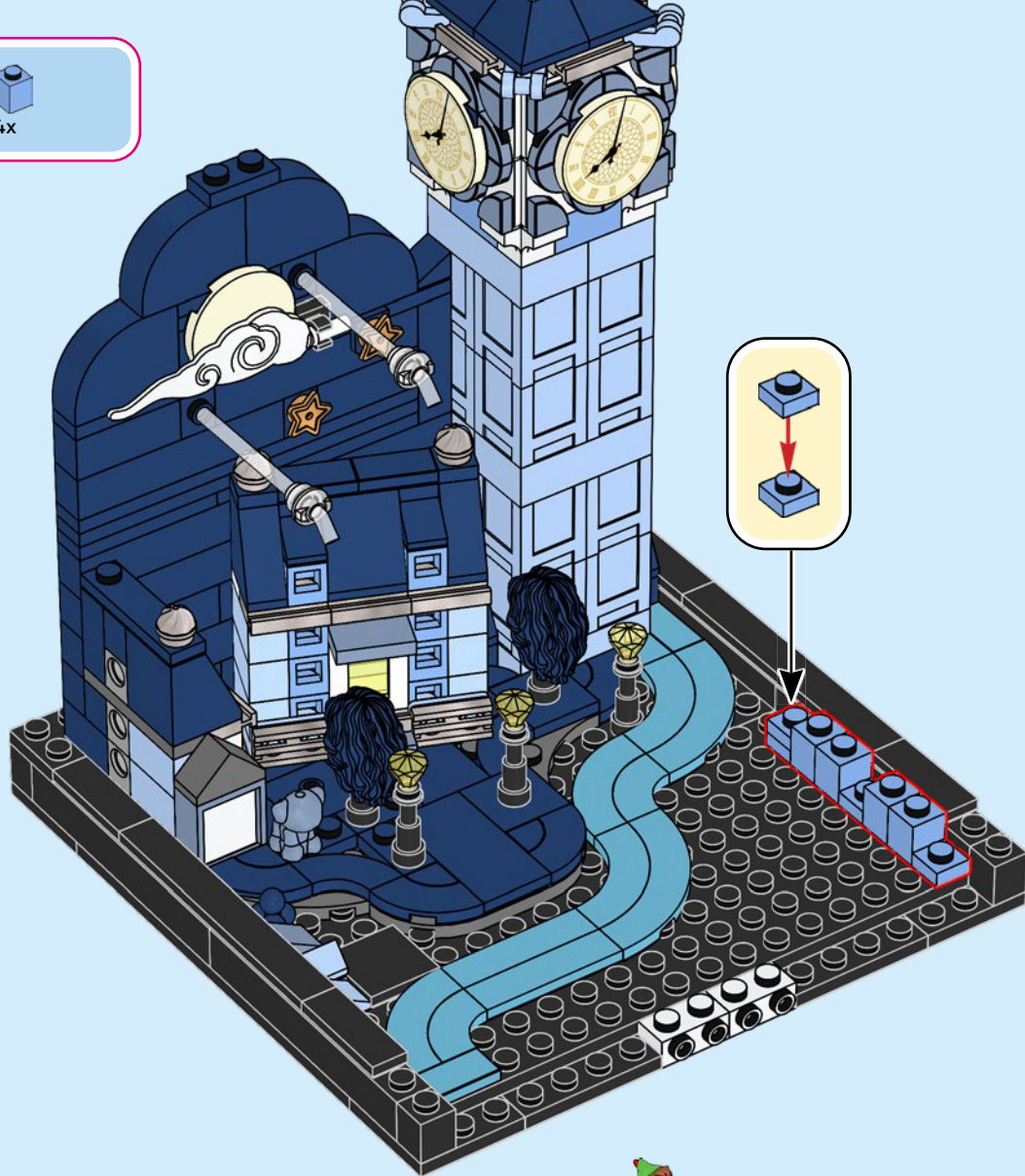





113



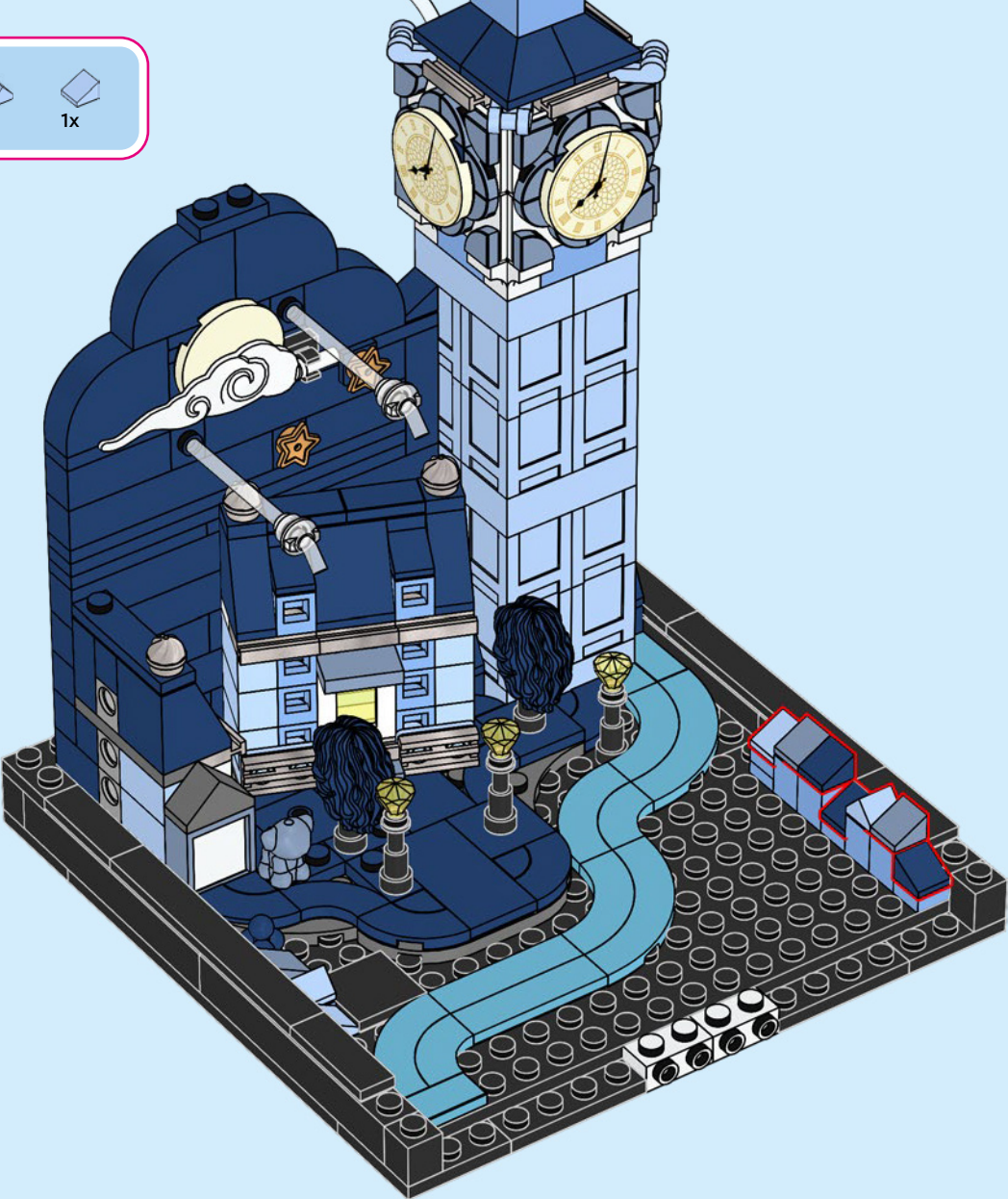

			
2x	3x	1x	1x



114



 2x  
 2x  
 4x

115

  
  
 2x

  
  
 2x

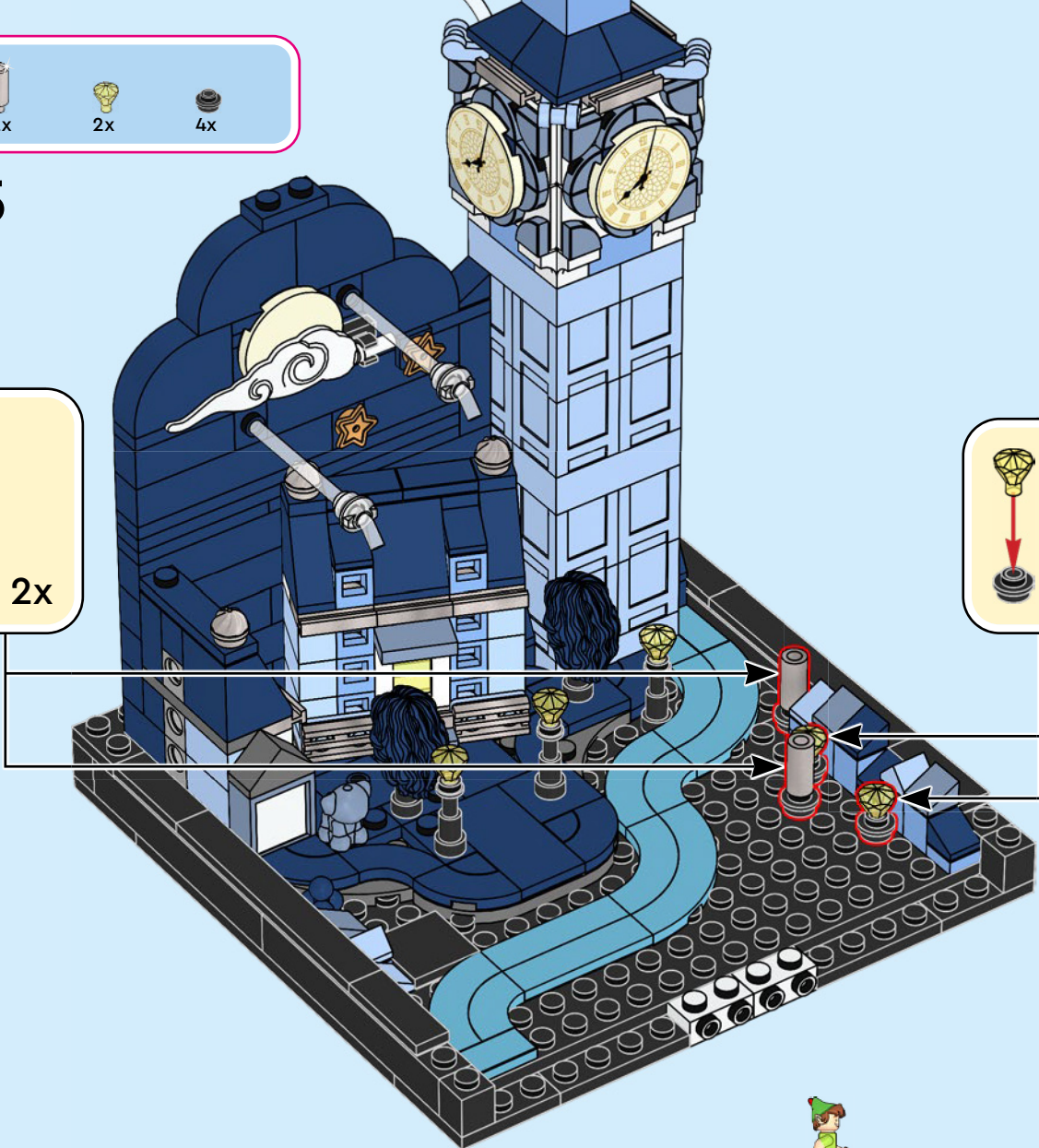

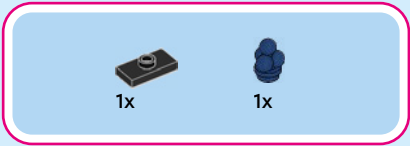

116

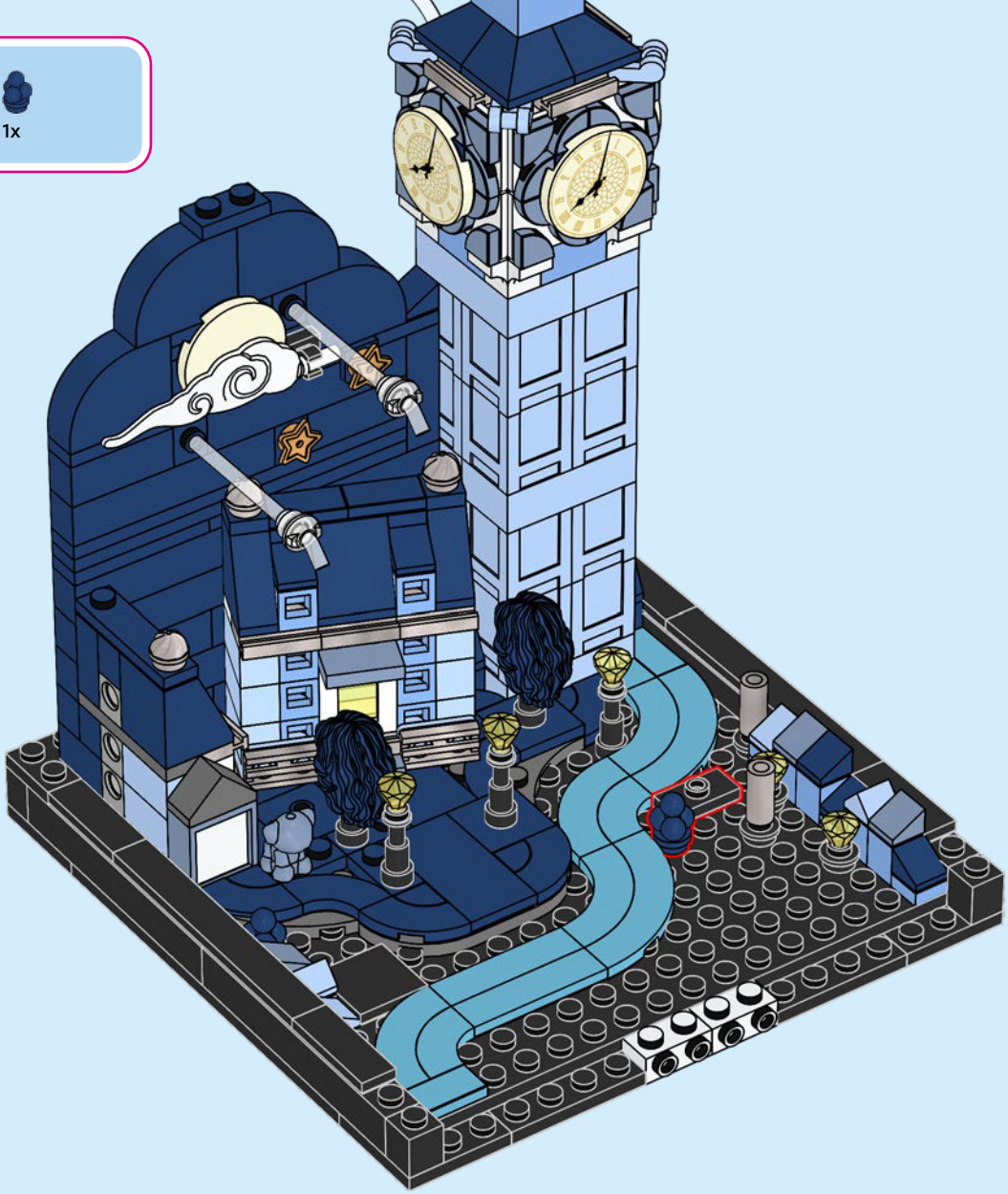



2x



2x

117

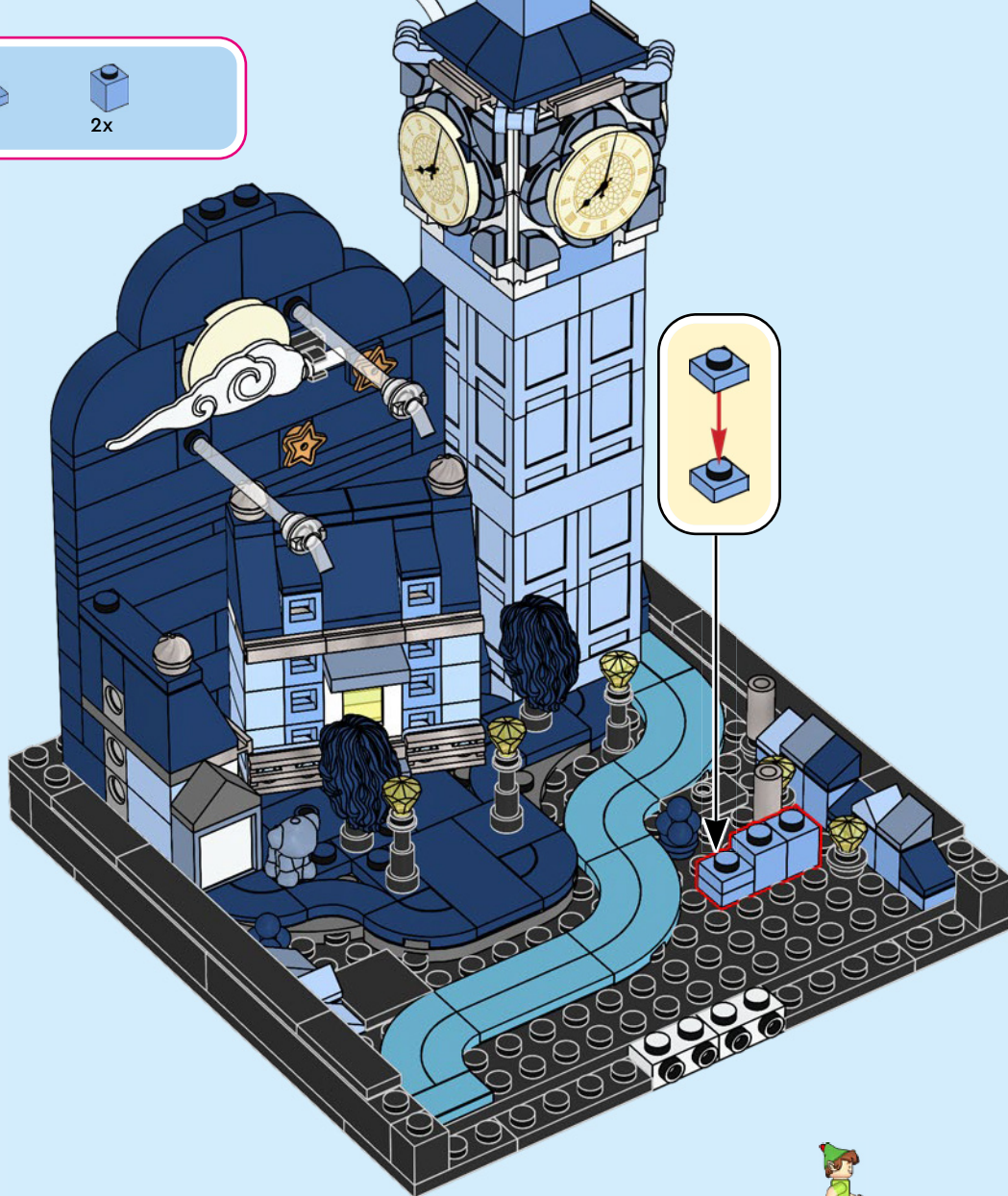

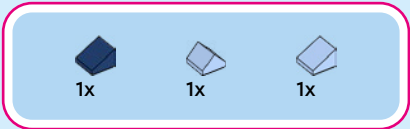

118

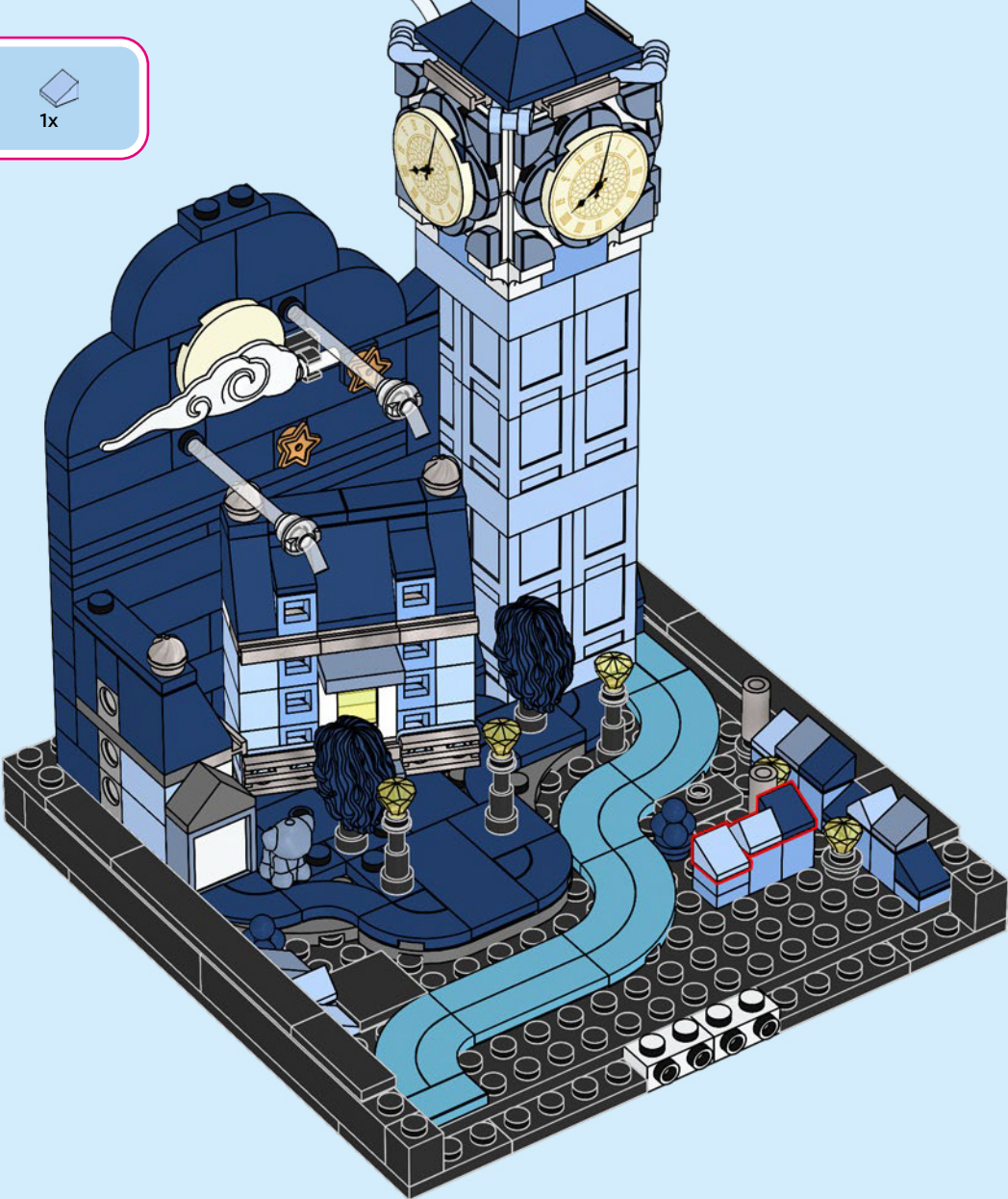

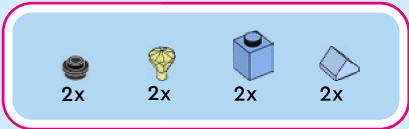

119

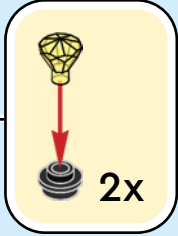
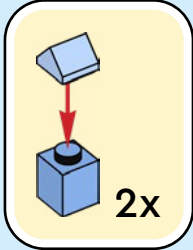



6x



2x

120





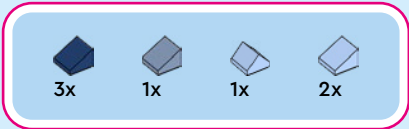

121



3x  1x 

122

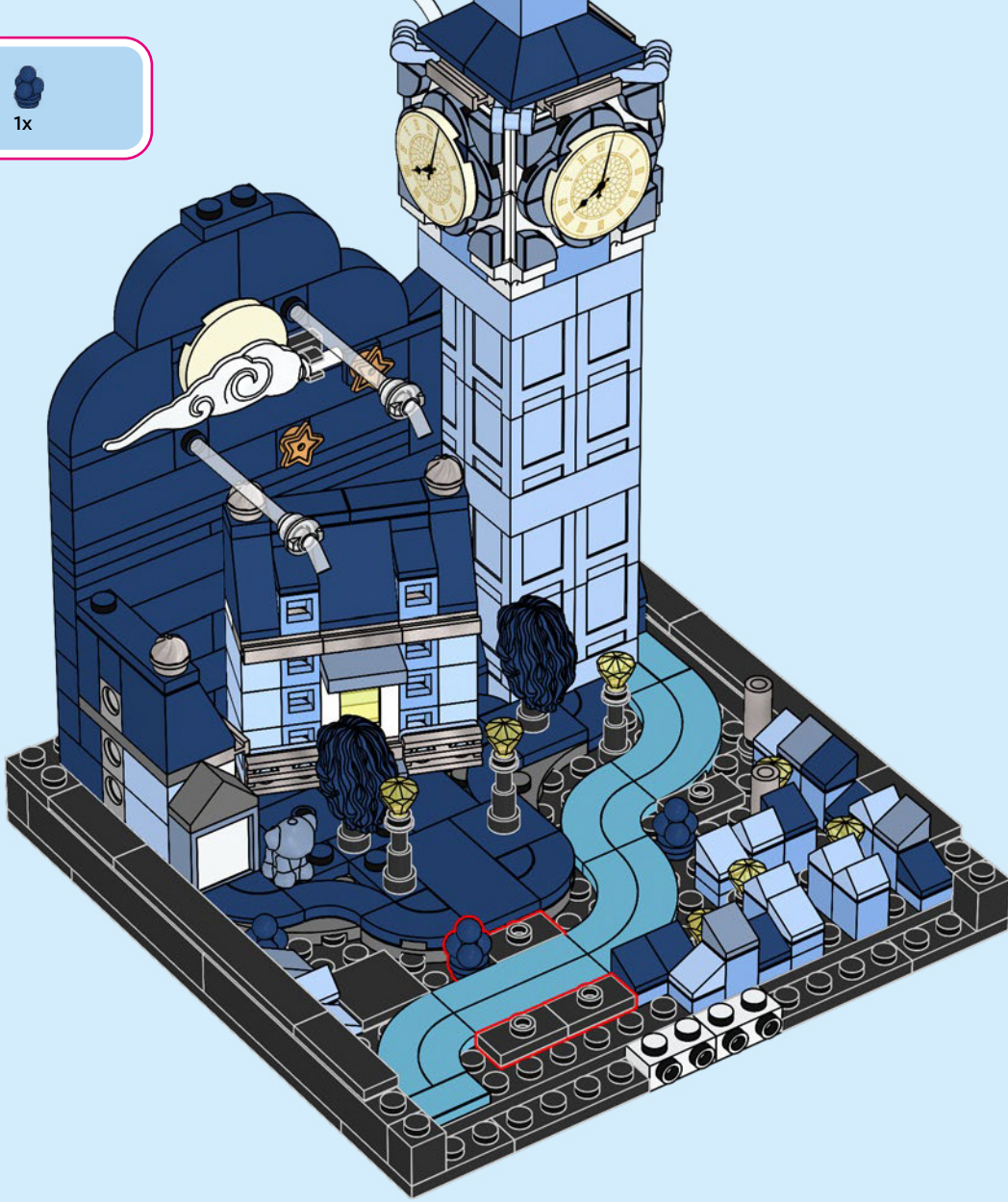

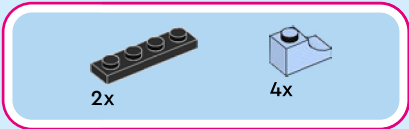

123

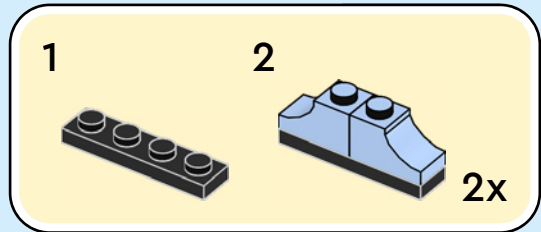
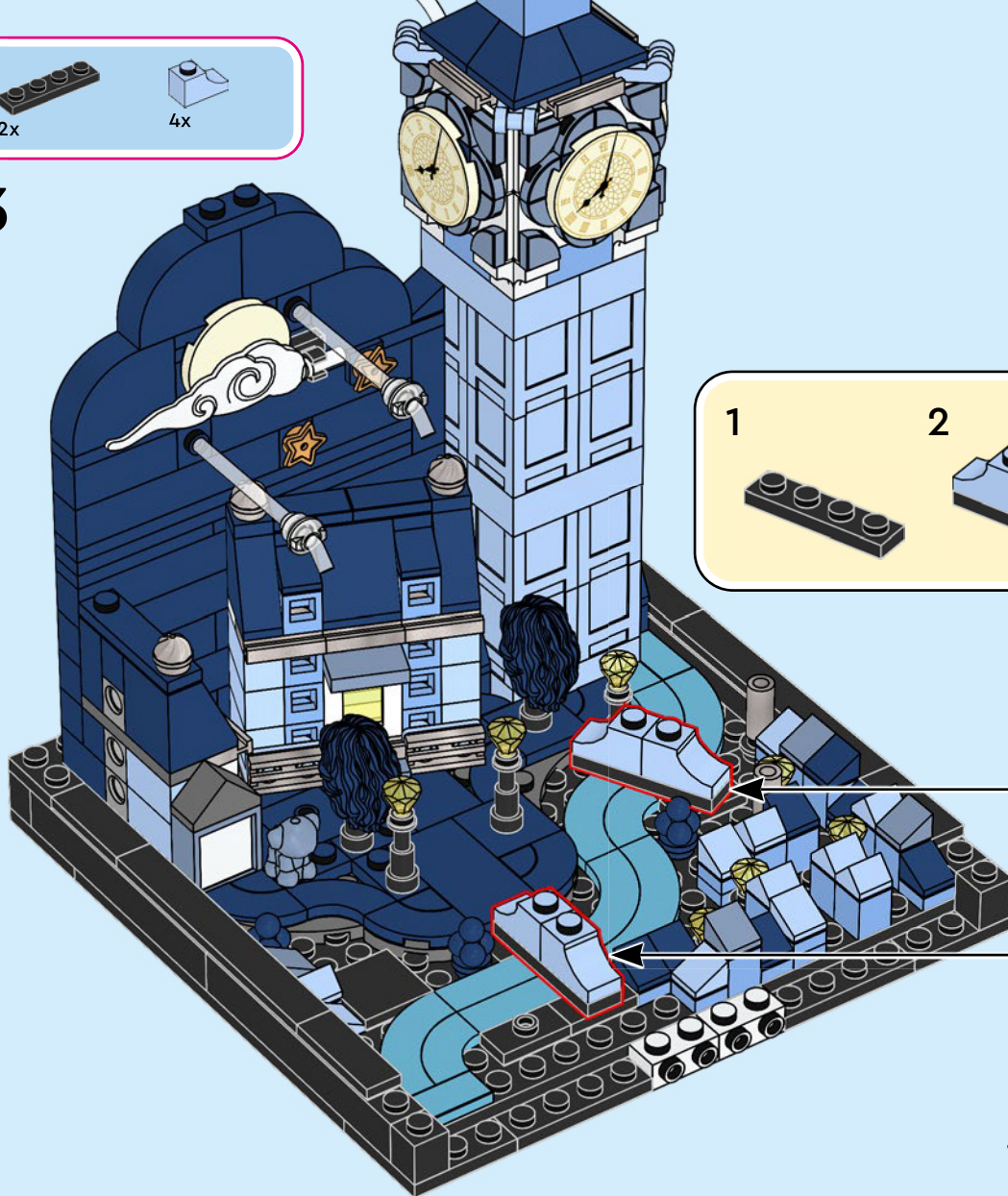

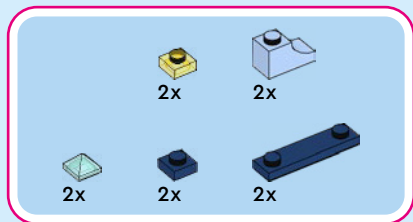

124

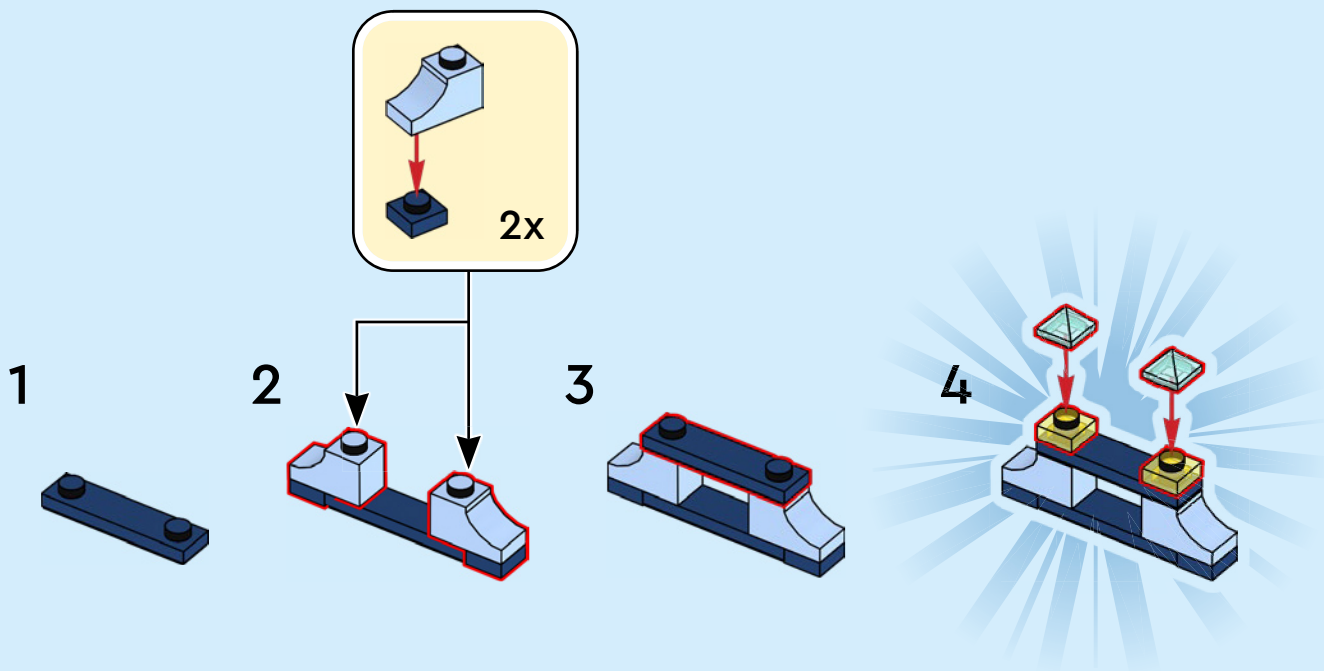

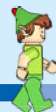



2x

125

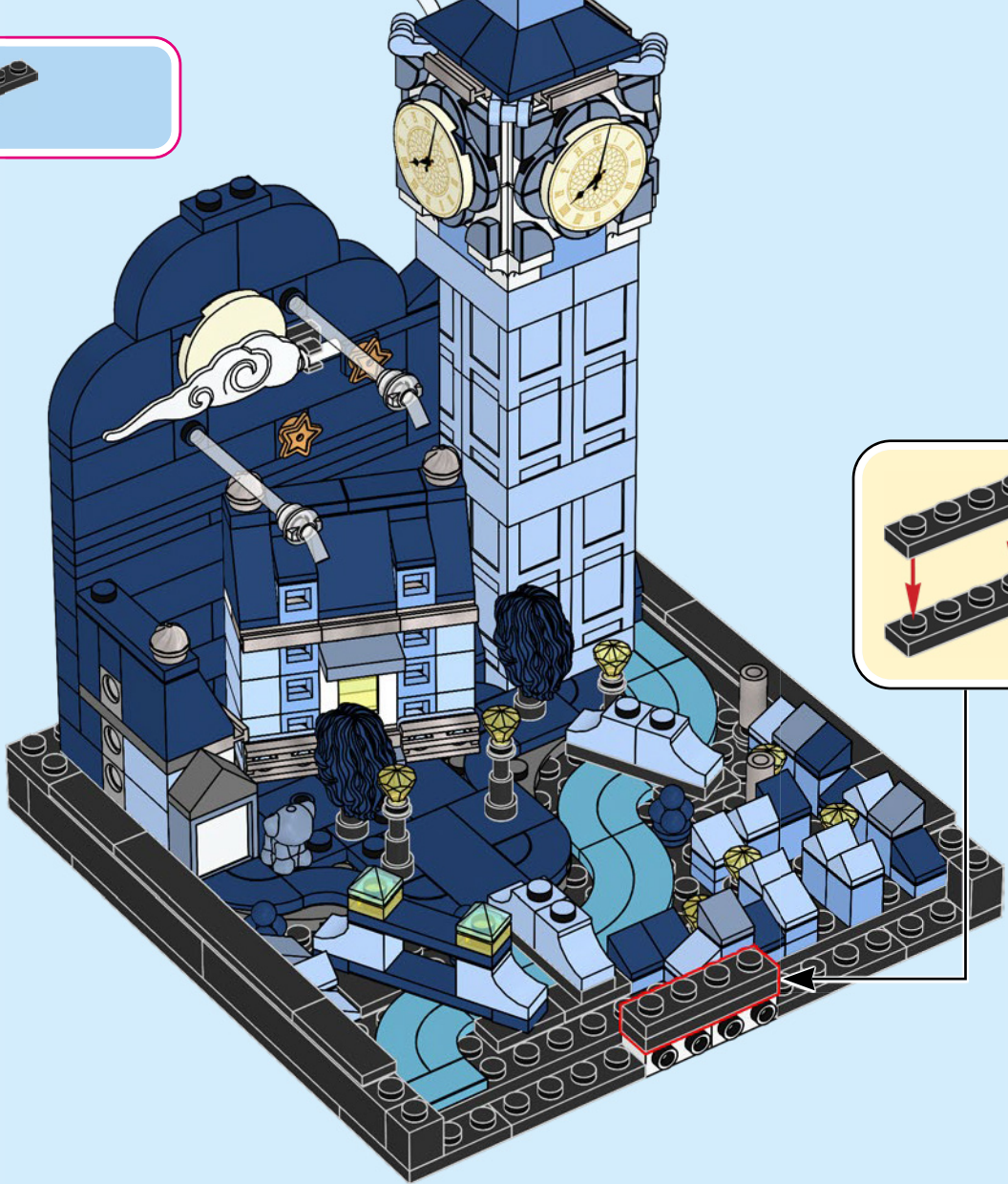

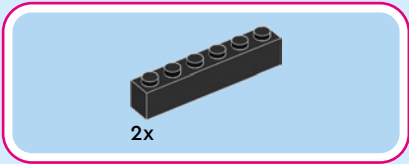

126



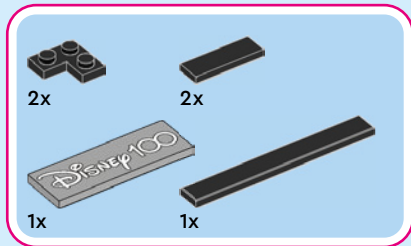

127

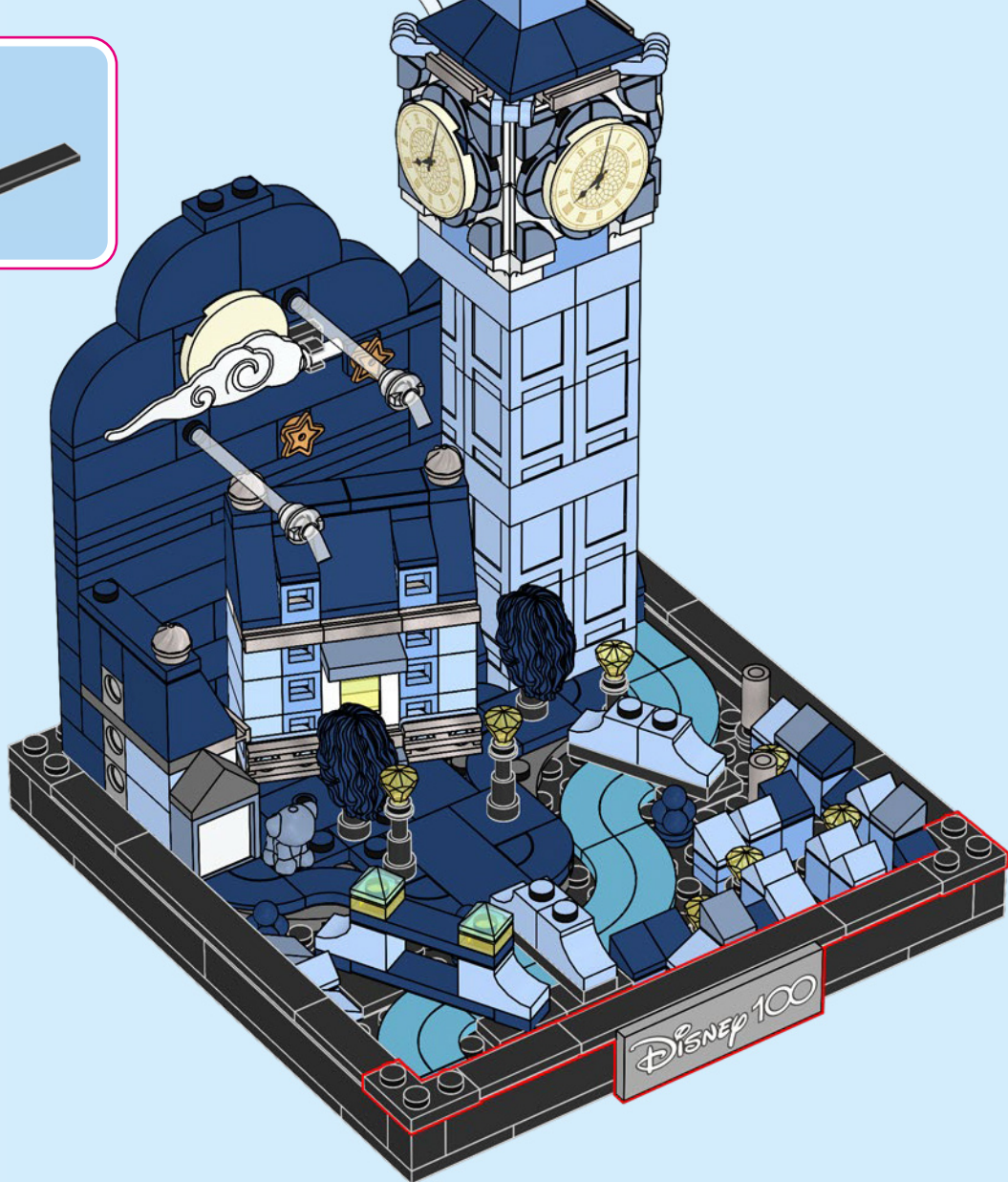







8x  
6389696

6x  
6199898

1x  
4296785

2x  
6144753

4x  
4196736

1x  
6153589

3x  
6233955

4x  
6097486

3x  
6256610

4x  
4264569

3x  
6224778

3x  
4502089

3x  
6103985

3x  
4569836

7x  
6221672

1x  
4508313

2x  
4507080

2x  
6200663

1x  
6258407

1x  
4226221

1x  
4210635

1x  
4211001

2x  
4211065

1x  
6388294

1x  
6389443

1x  
4222042

2x  
4210997

2x  
6209683

6x  
6228085

5x  
6372124

4x  
6438967

6x  
6383091

11x  
6100322

2x  
6372232

1x  
6444932

16x  
6383137

1x  
6454349

7x  
6287903

3x  
6460975

1x  
6157793

1x  
6440634

1x  
6422797

1x  
6422800

2x  
4114319

1x  
6254100

2x  
6336564

3x  
6058160

2x  
4619636

10x  
6132264

1x  
6345579

3x  
6440876

5x  
4211535

1x  
6440895

1x  
6438985

2x  
6184647

1x  
4655243

2x  
4649741

2x  
6258069

2x  
4624705

4x  
6377248

2x  
6252553



 [LEGO.com/service](https://www.LEGO.com/service)

YOU COULD **WIN**



Scan this QR code or go to **LEGO.COM/PRODUCTFEEDBACK** and give us your short feedback about this LEGO® set for a chance to win a cool LEGO prize.

Terms and Conditions apply\*

**EN: YOU COULD WIN.** Terms and Conditions apply\* **DE: Du könntest GEWINNEN.** Es gelten die Teilnahmebedingungen\* **FR: Tu pourrais GAGNER.** Des conditions s'appliquent\* **IT: Potresti VINCERE tu.** Termini e condizioni sono applicabili\* **ES: Puedes GANAR.** Aplican términos y condiciones\* **PT: Poderá GANHAR.** Aplicam-se termos e condições\* **ZH: 轻松获奖. 条款和条件适用\*** **PL: Szansa na WYGRANĄ.** Obowiązują warunki korzystania\* **CS: Máte šanci VYHRÁT.** Platí všeobecné smluvní podmínky\* **SK: Máte šancu VYHRAŤ.** Platia všeobecné zmluvné podmienky\* **HU: TE IS NYERHETSZ.** Felhasználási feltételek érvényesek\* **RO: Ai putea CÂȘTIGA.** Se aplică termeni și condiții\* **BG: Можете да СПЕЧЕЛИТЕ.** Има определени правила и условия\* **LV: Tu vari LAIMĒT.** Ir spēkā noteikumi un nosacījumi.\* **ET: Sul on võimalus VÕITA.** Kehtivad tingimused\* **LT: Jūs galite LAIMĖTI.** Taikomos sąlygos\*

\*[LEGO.com/productfeedback-terms](https://www.lego.com/productfeedback-terms)

LEGO and the LEGO logo are trademarks of the/sont des marques de commerce du/son marcas registradas de LEGO Group. ©2023 The LEGO Group. ©Disney