



Harry Potter



4866



1

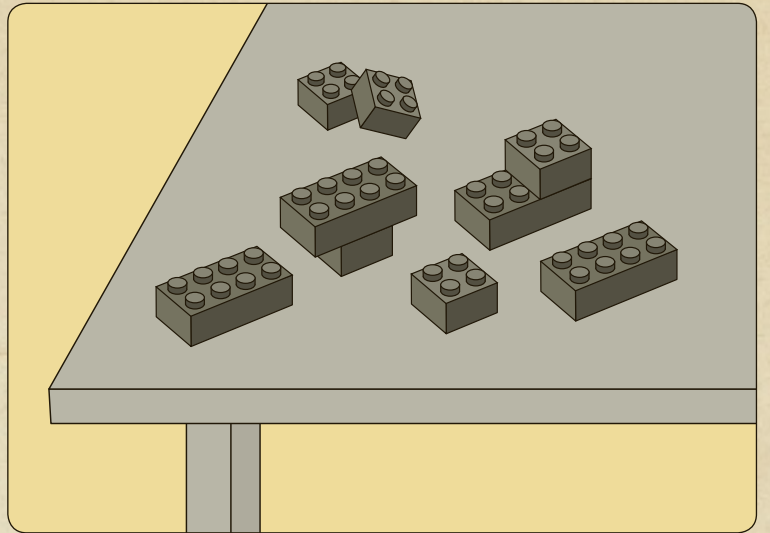
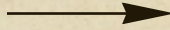
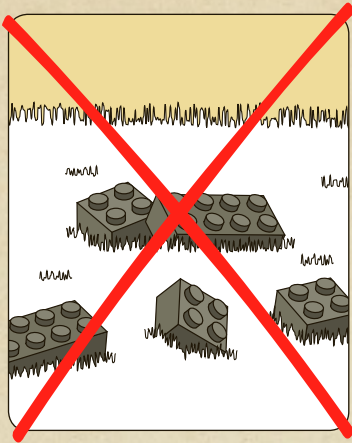

2



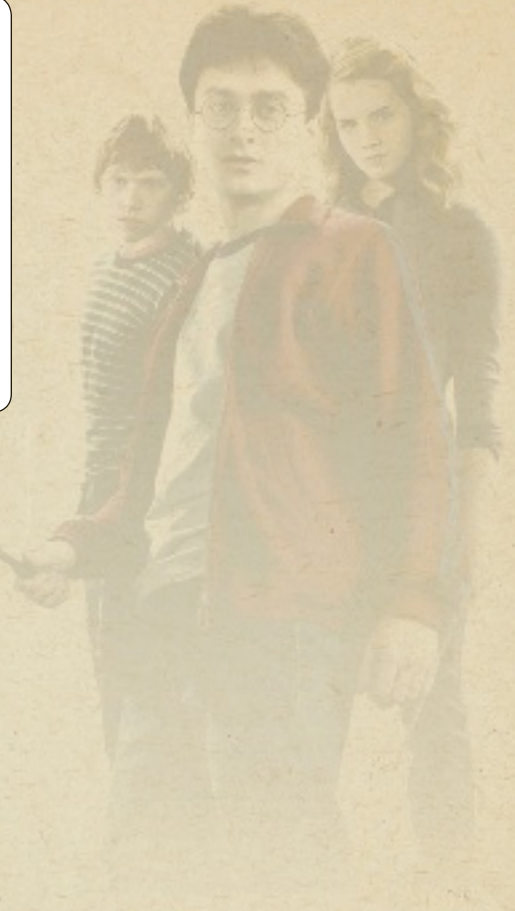
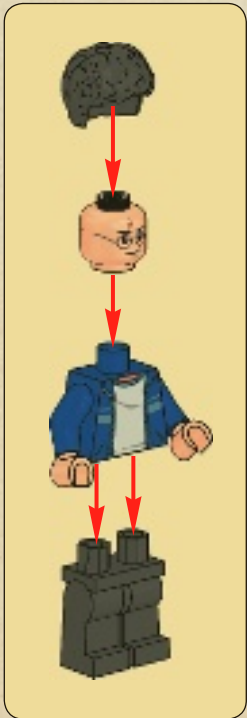
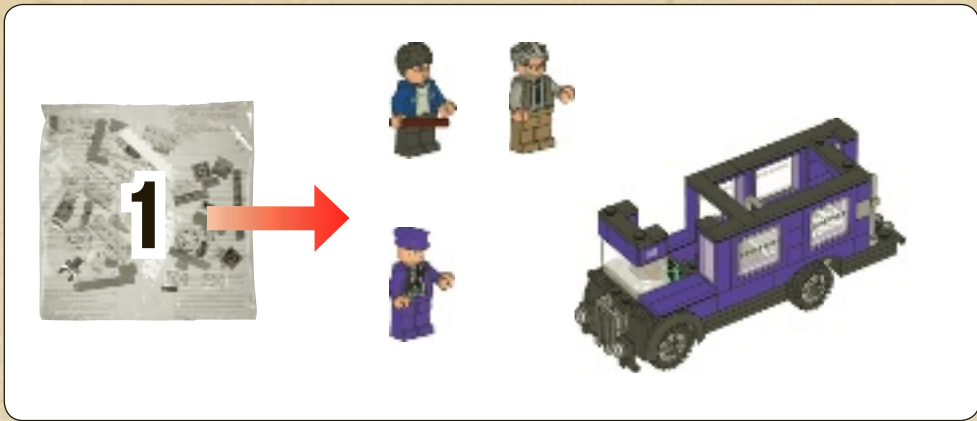

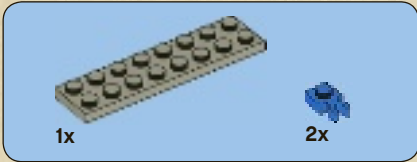

1

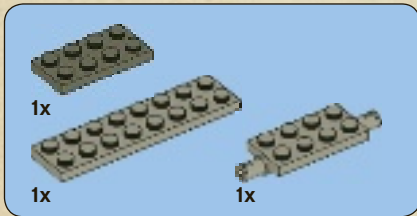
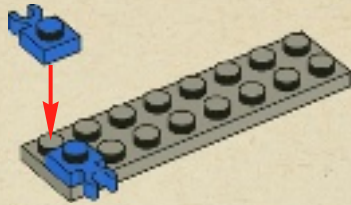

2

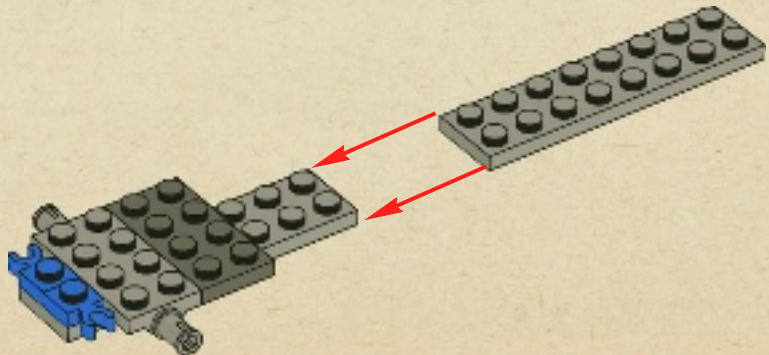

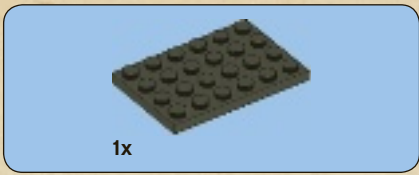

3

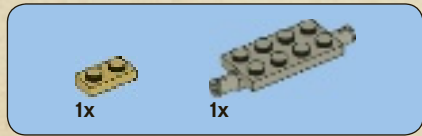
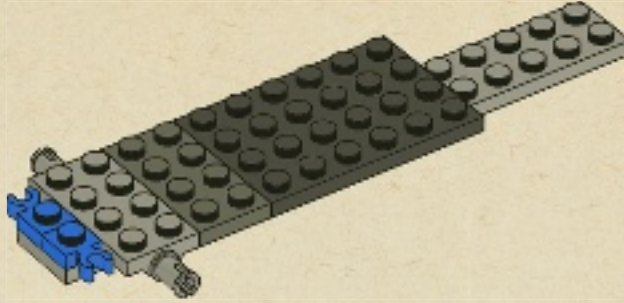

4

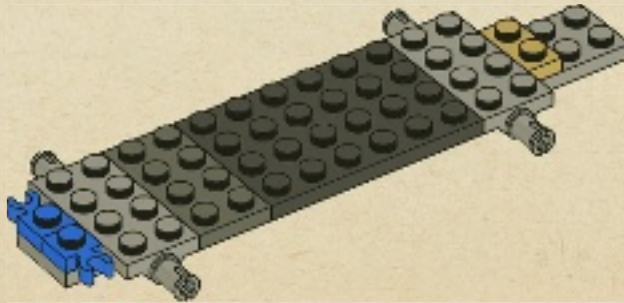

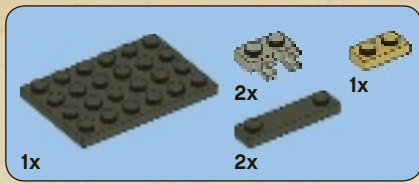

5

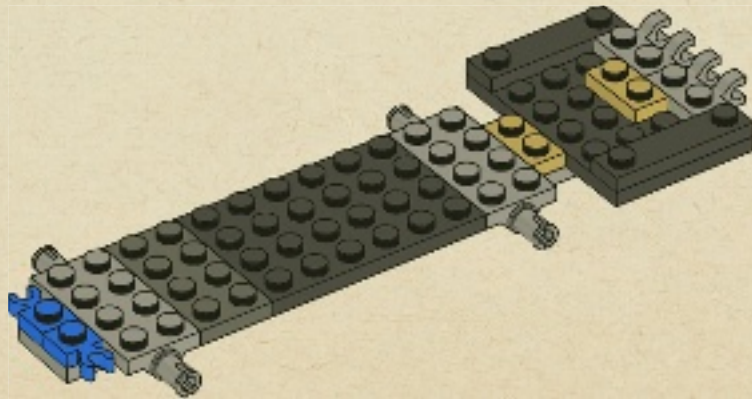
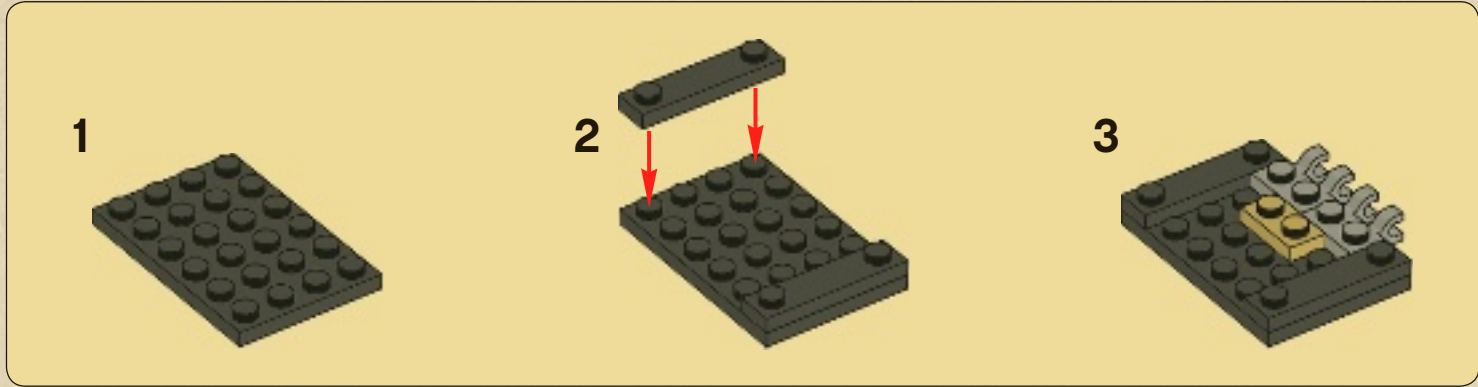

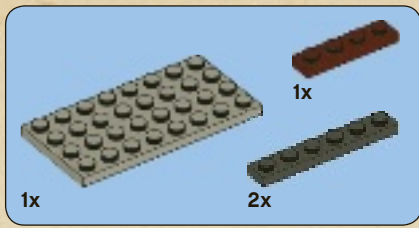

6

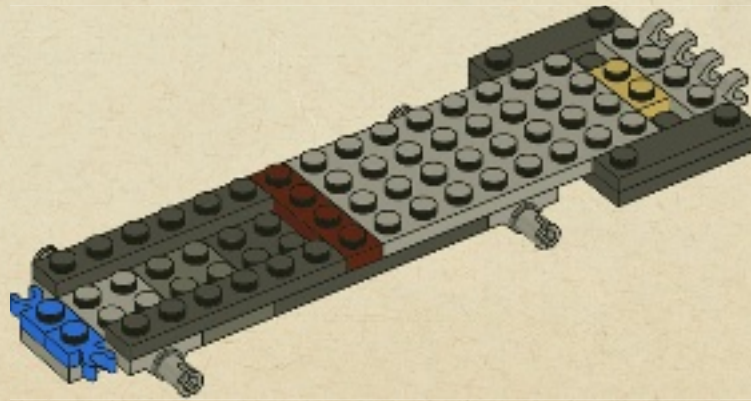



7

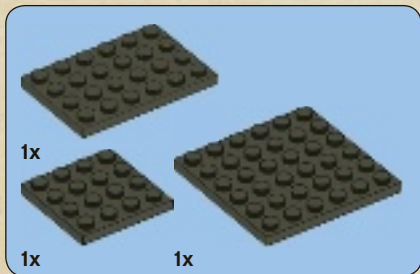
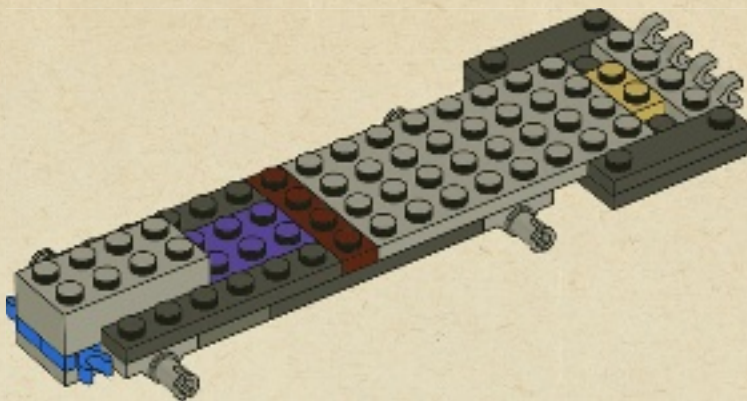

8

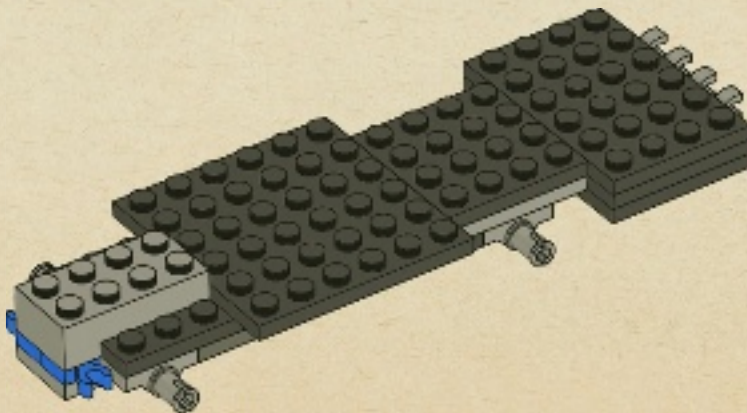



9

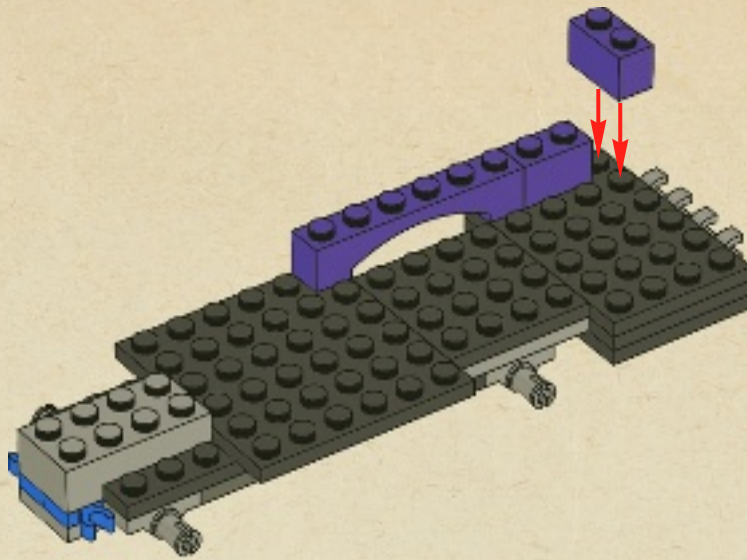

10

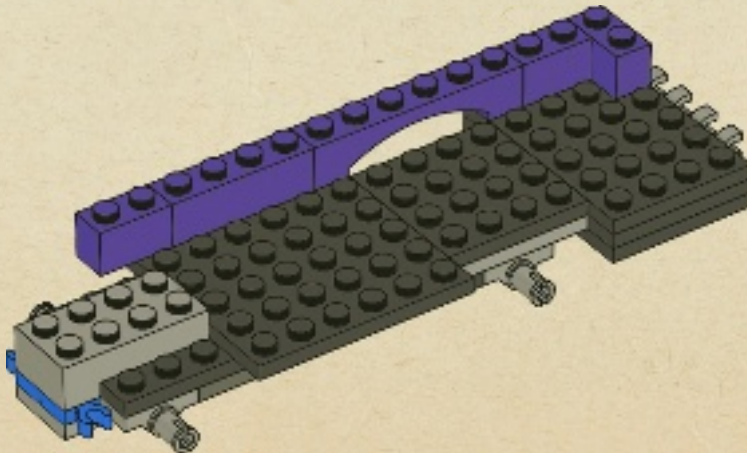

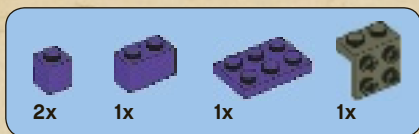

11

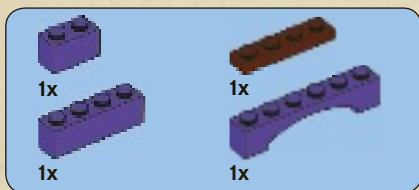
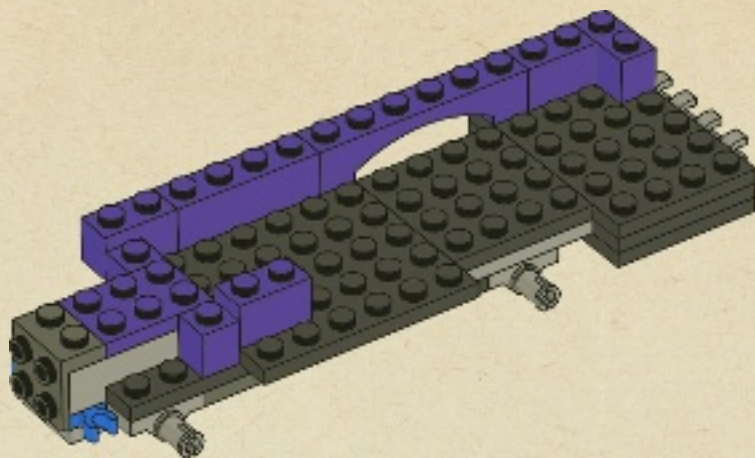

12

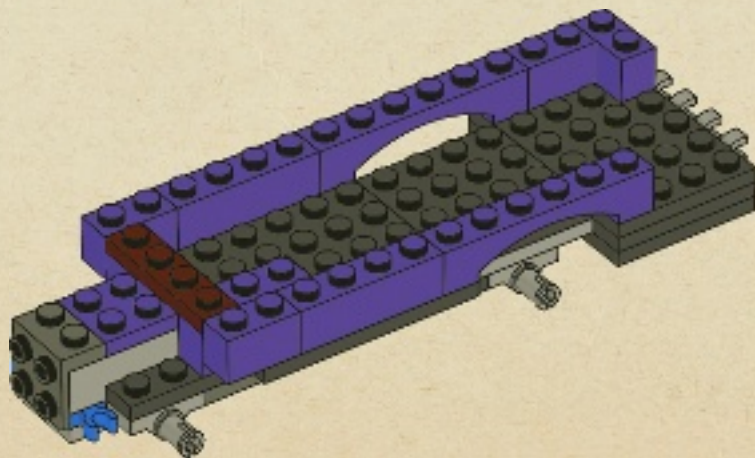



1x



1x



1x

13

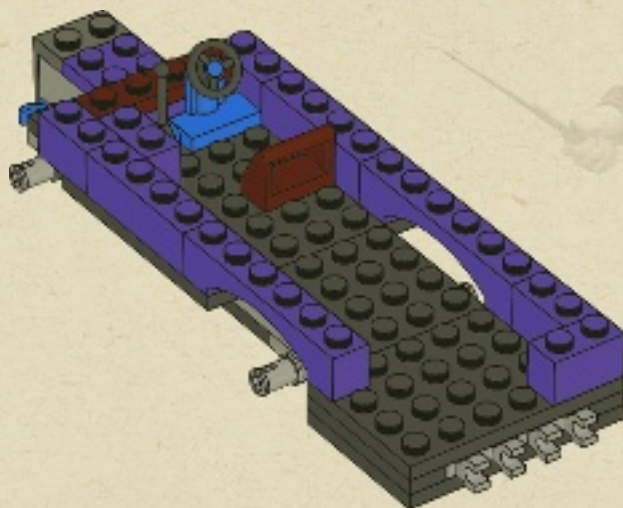

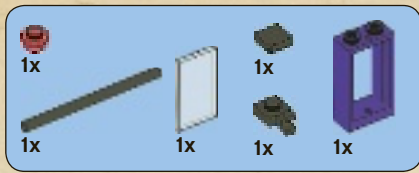

14

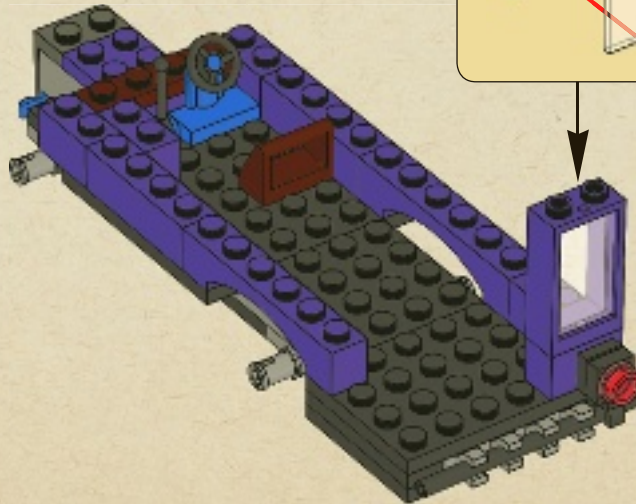
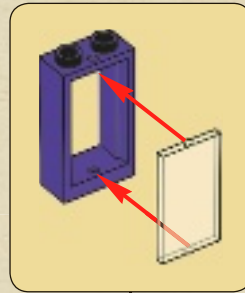

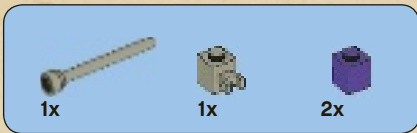

15

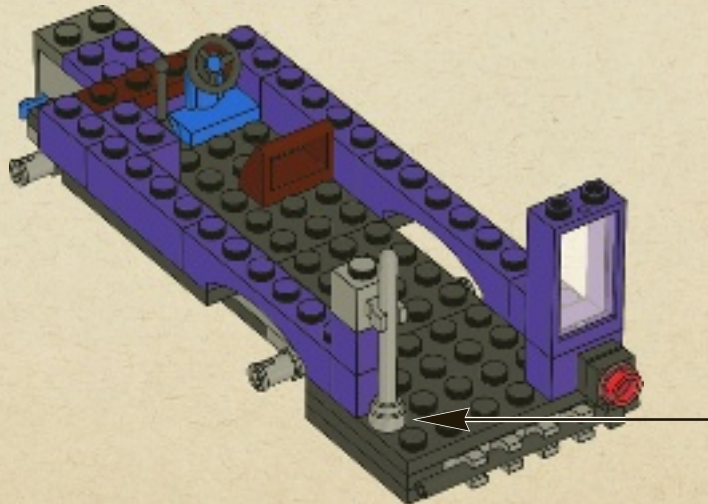
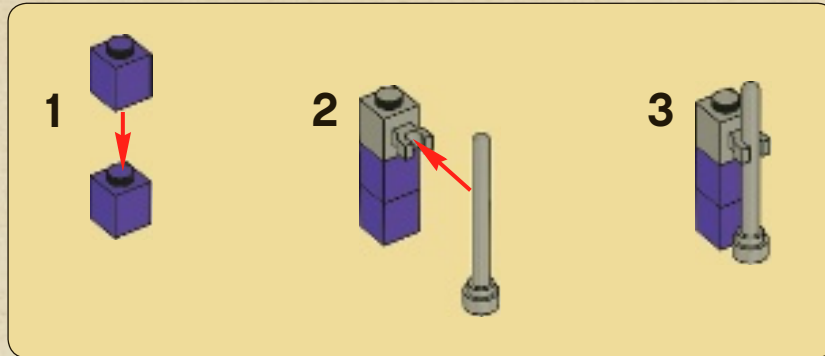

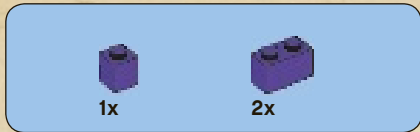

16

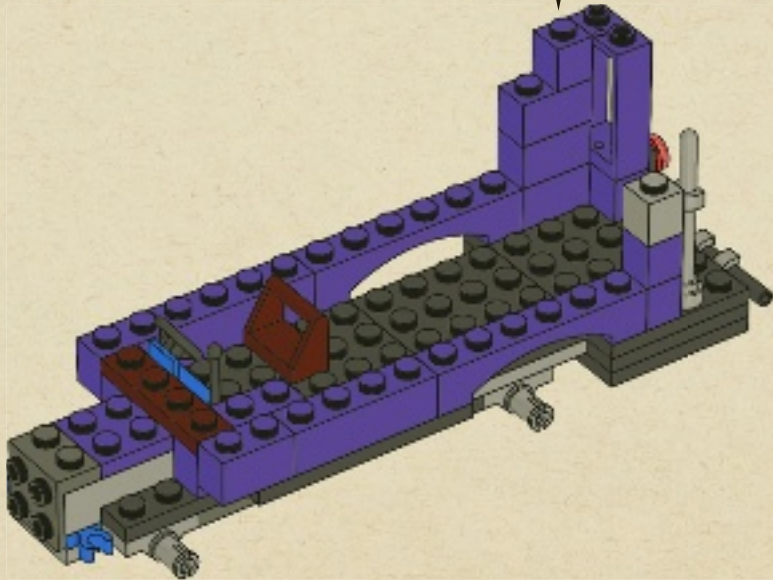
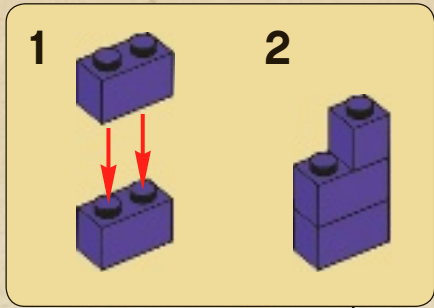

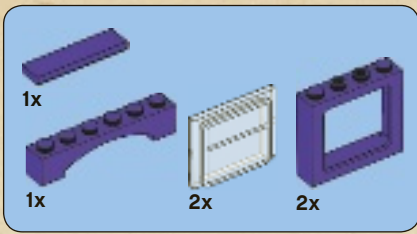

17

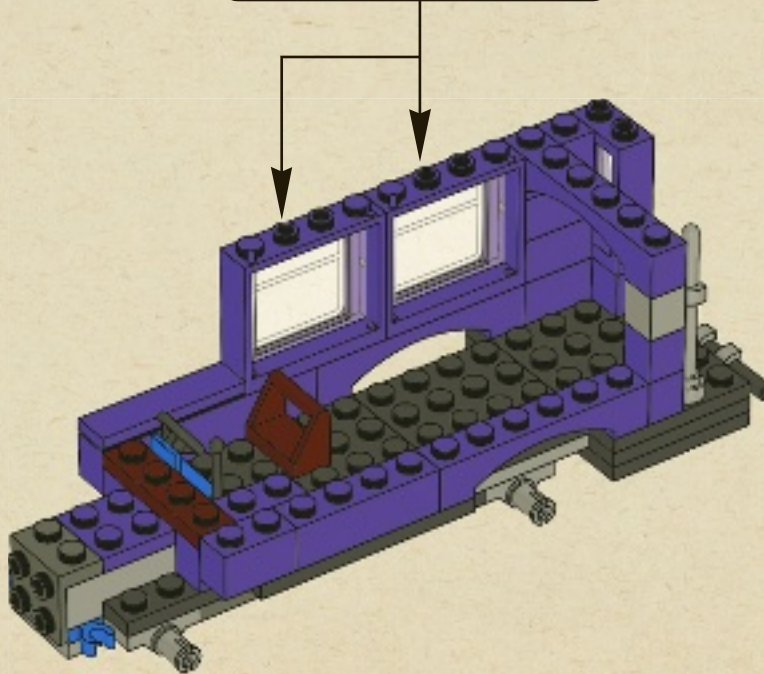
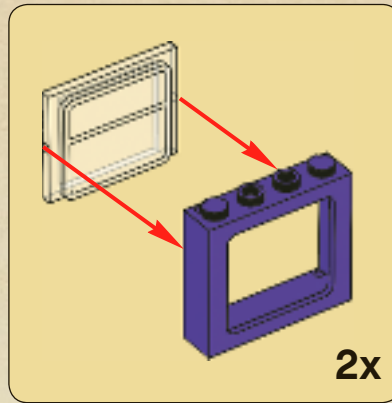

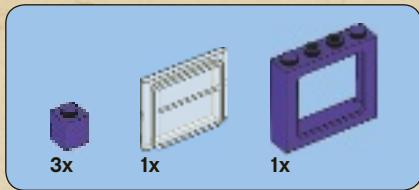

18

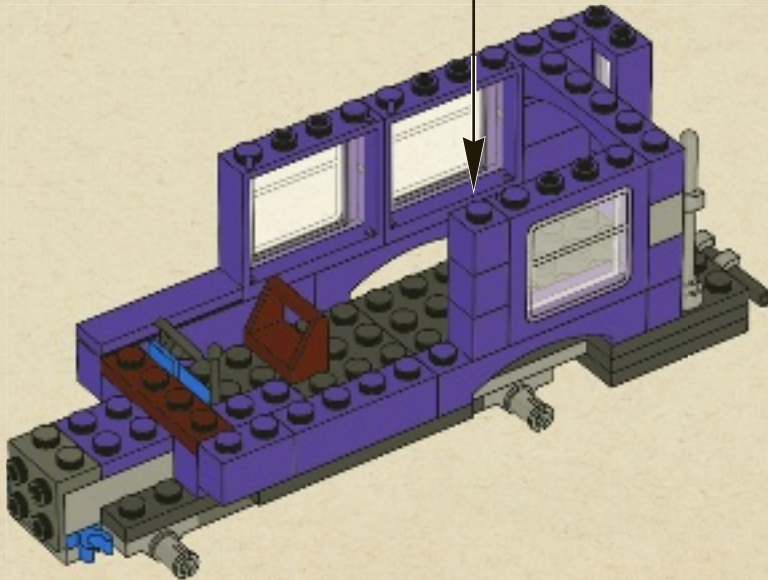
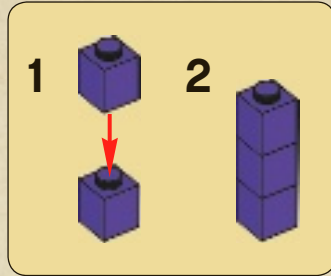

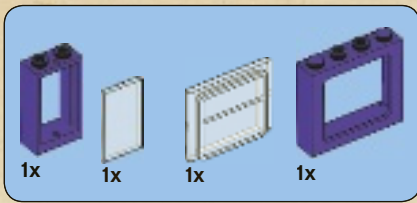

19

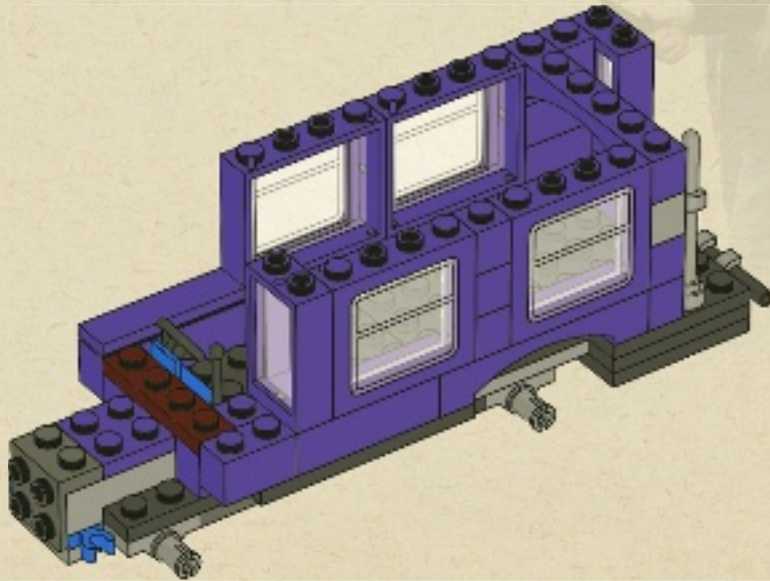

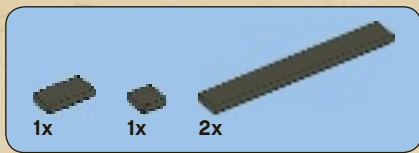

20

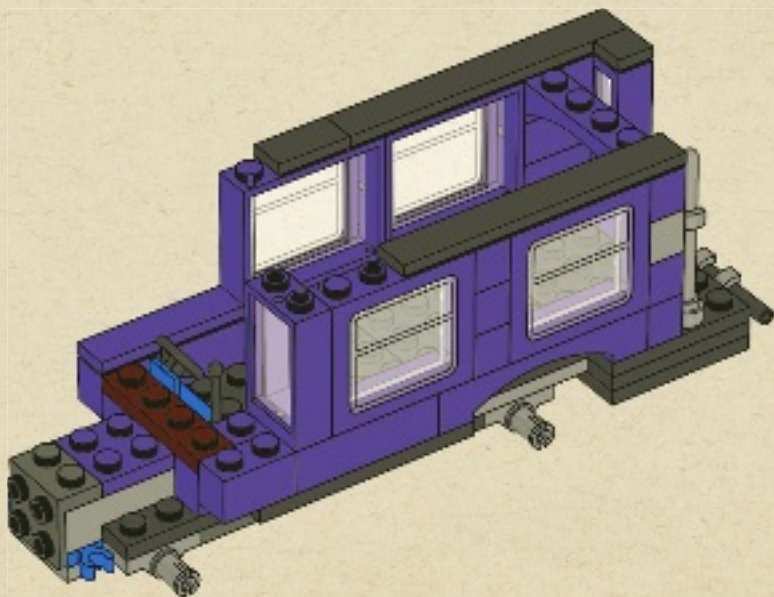



4x



4x

21

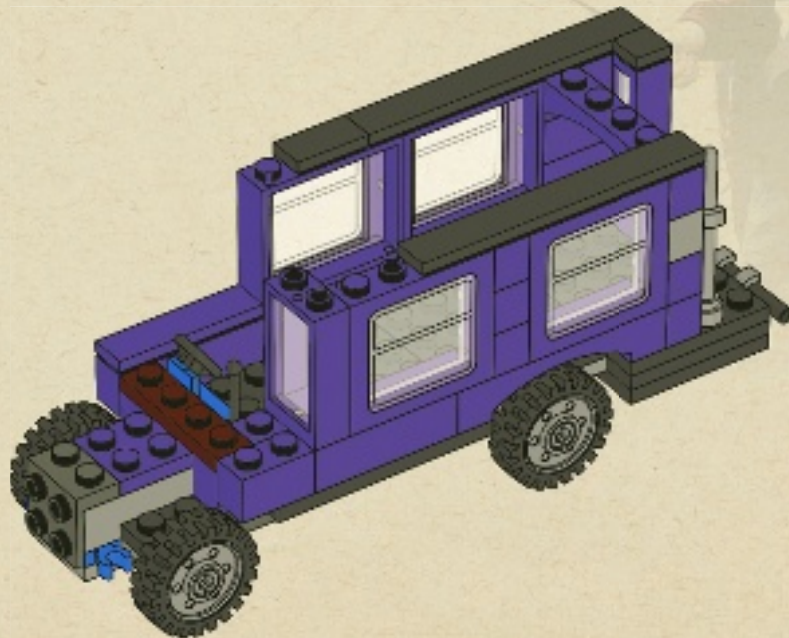



2x

22

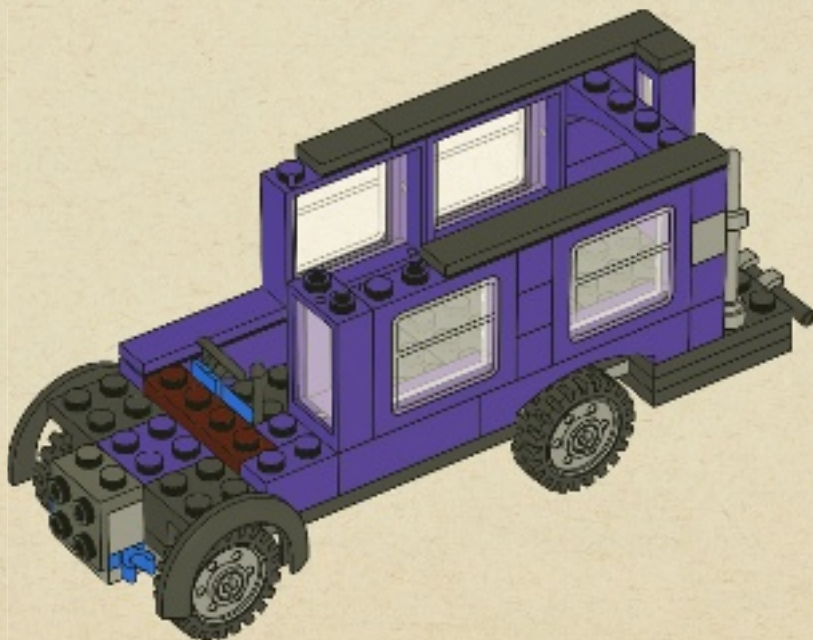



1x



1x

23

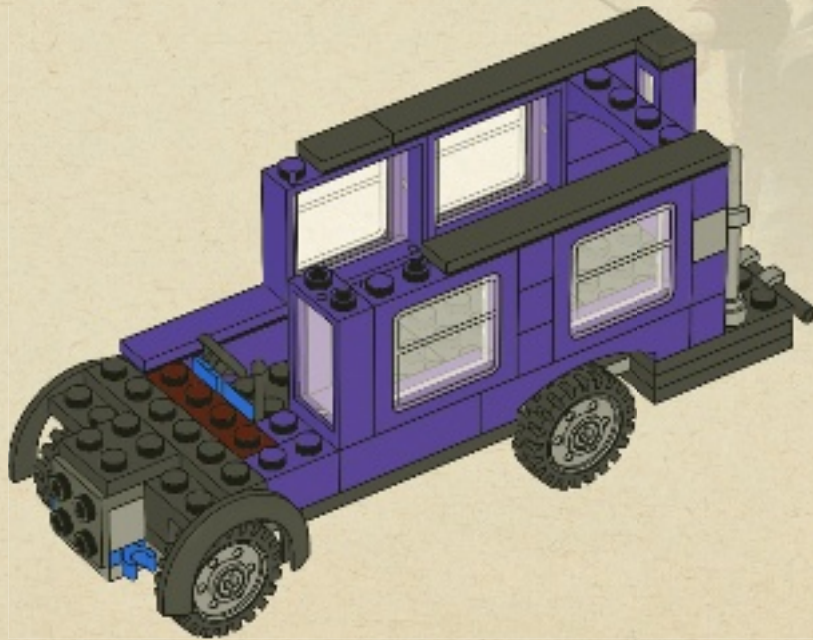



24

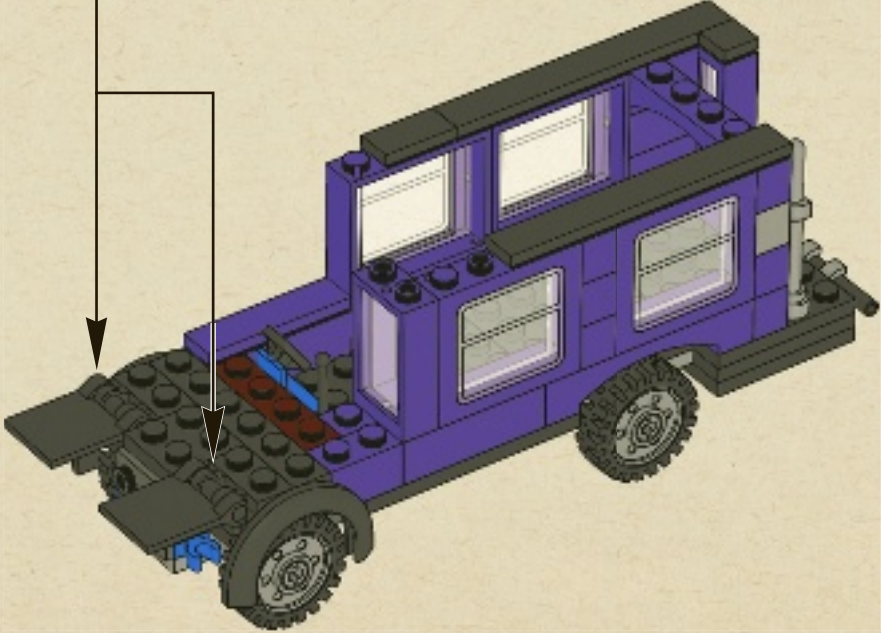
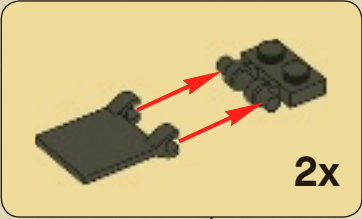



2x



1x

25

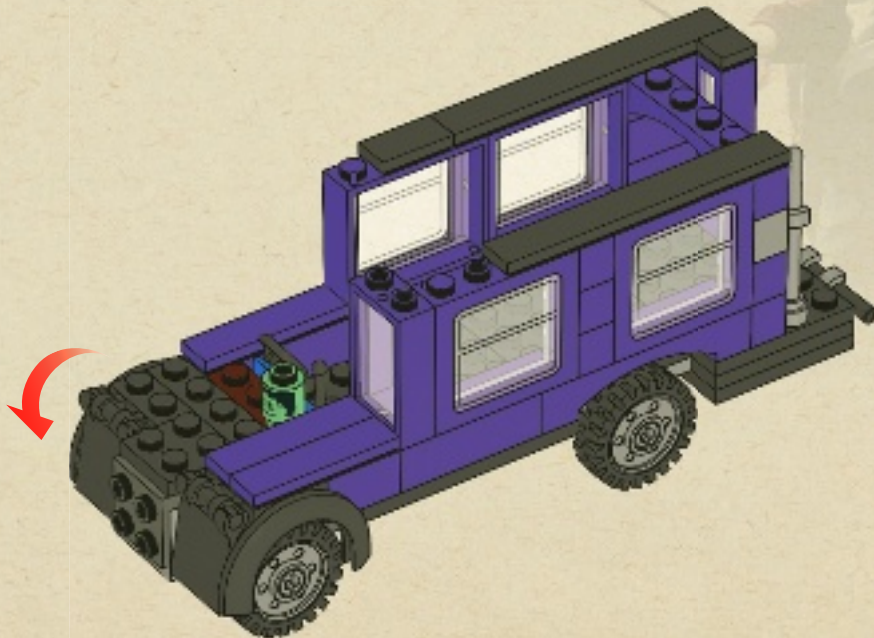



26

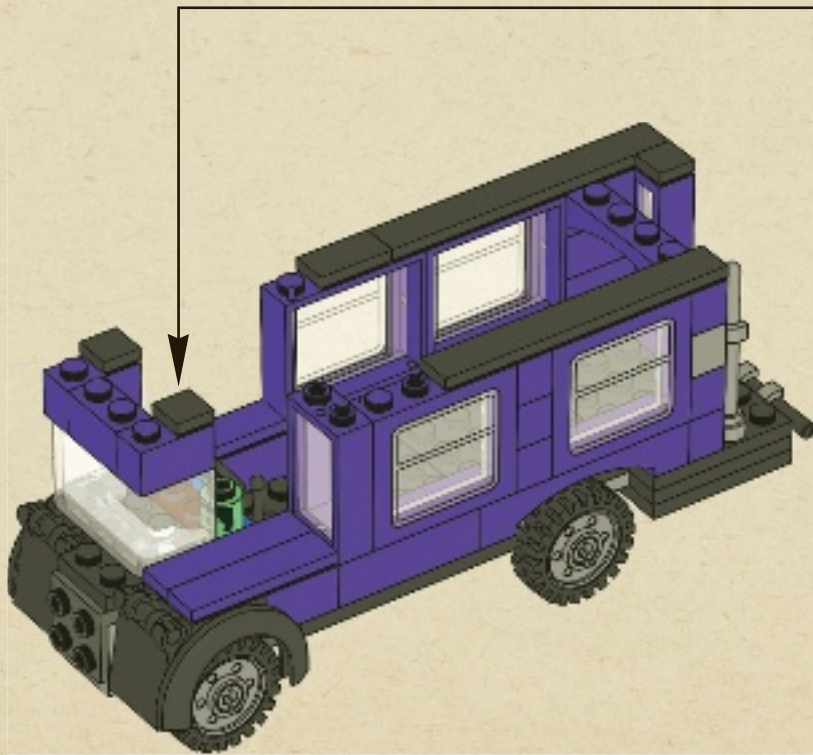
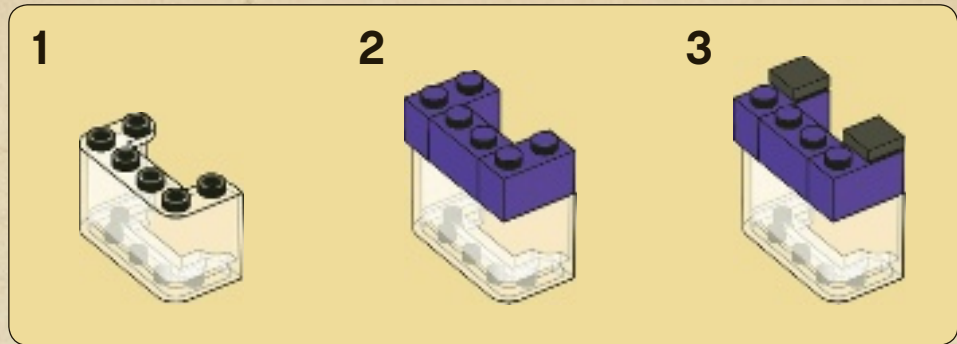

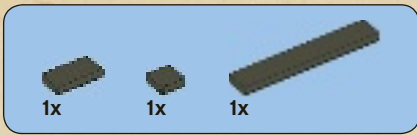

27

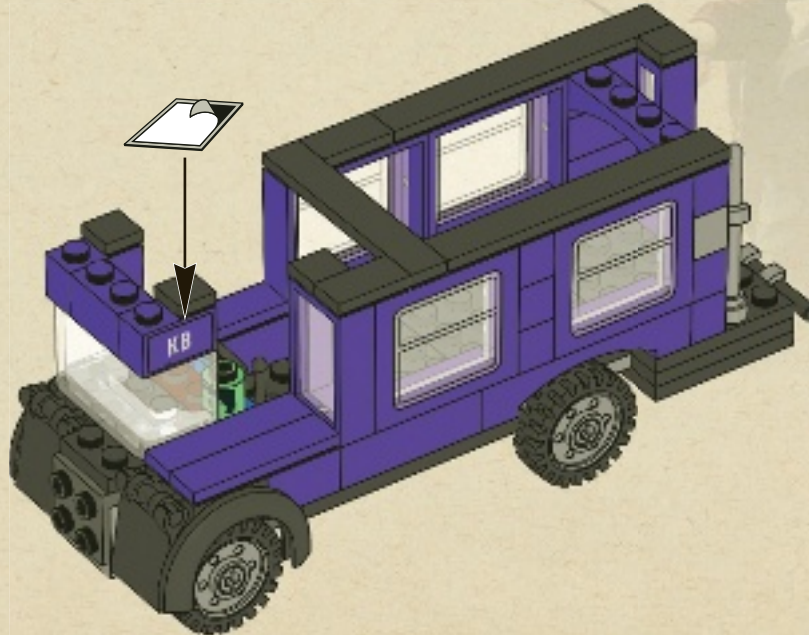



28

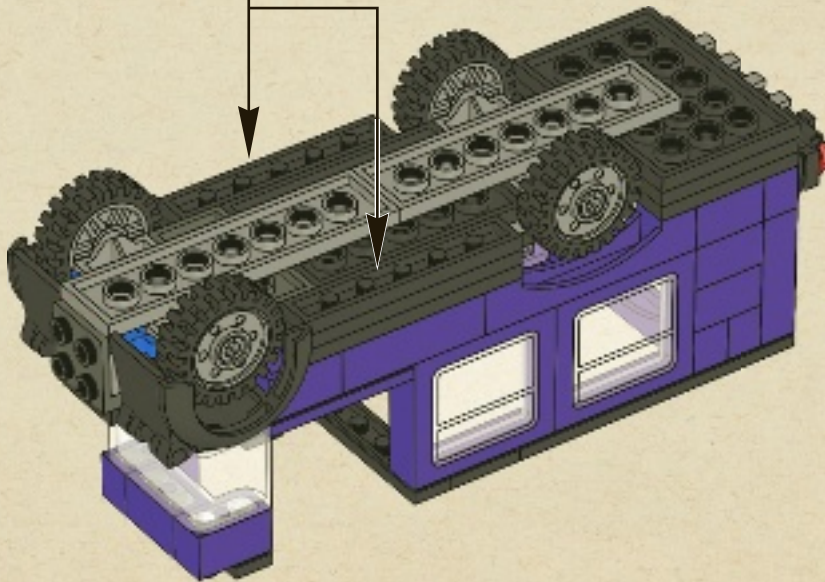
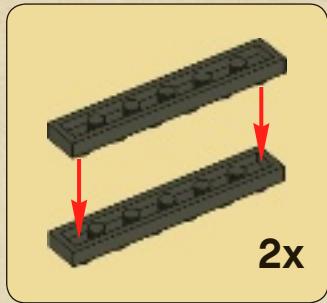



2x

29

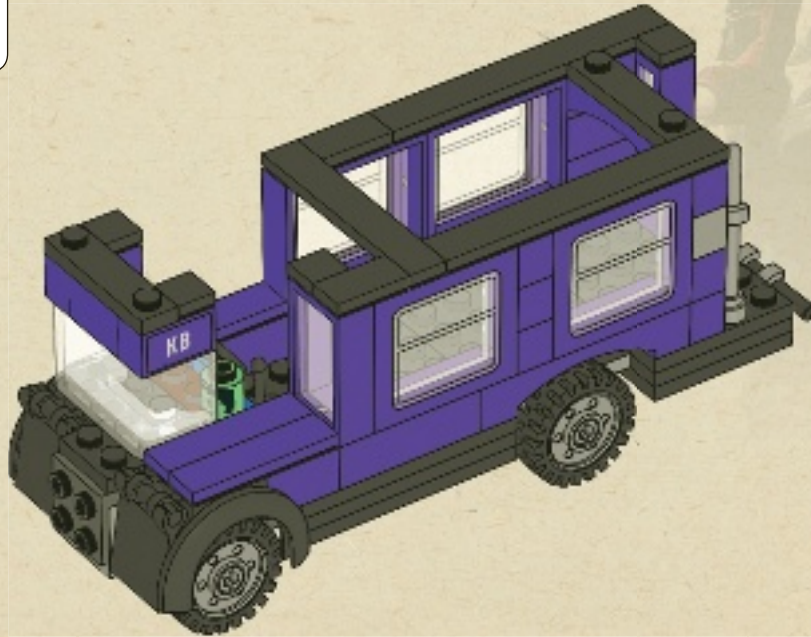

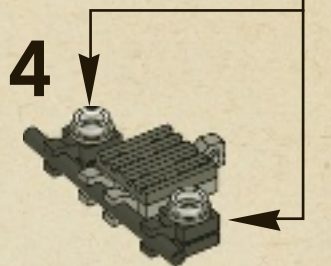
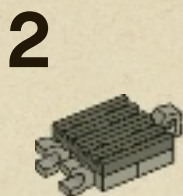
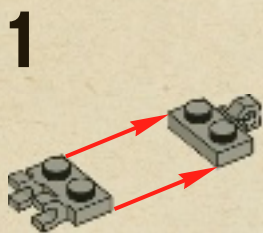
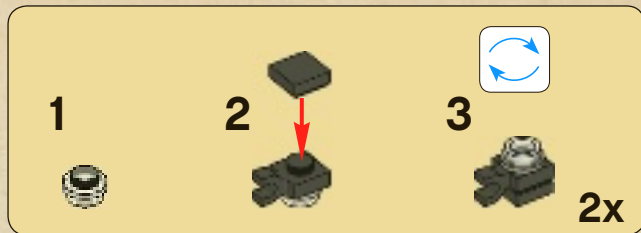
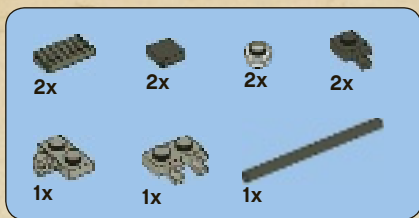

30

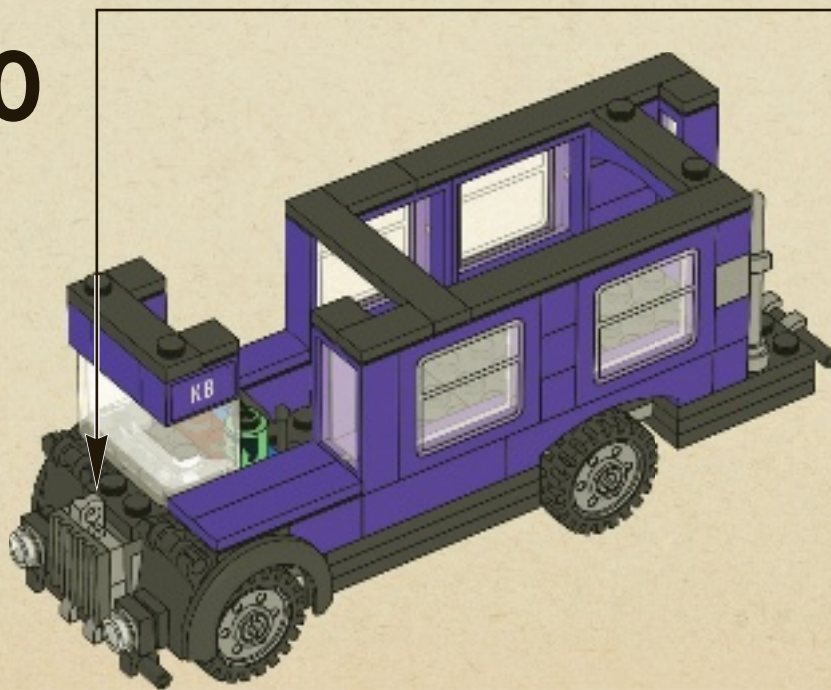

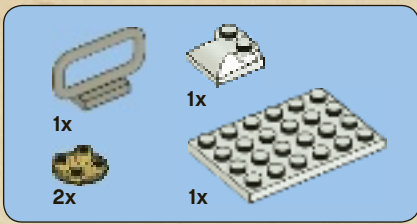

1

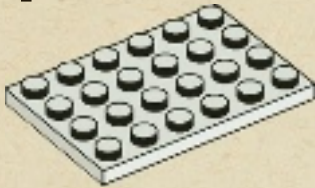

2

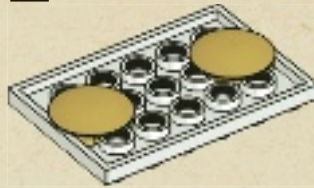
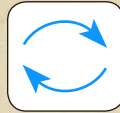

3

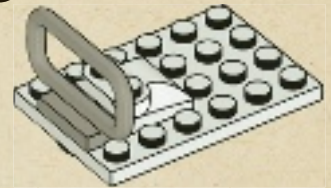
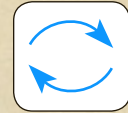

31

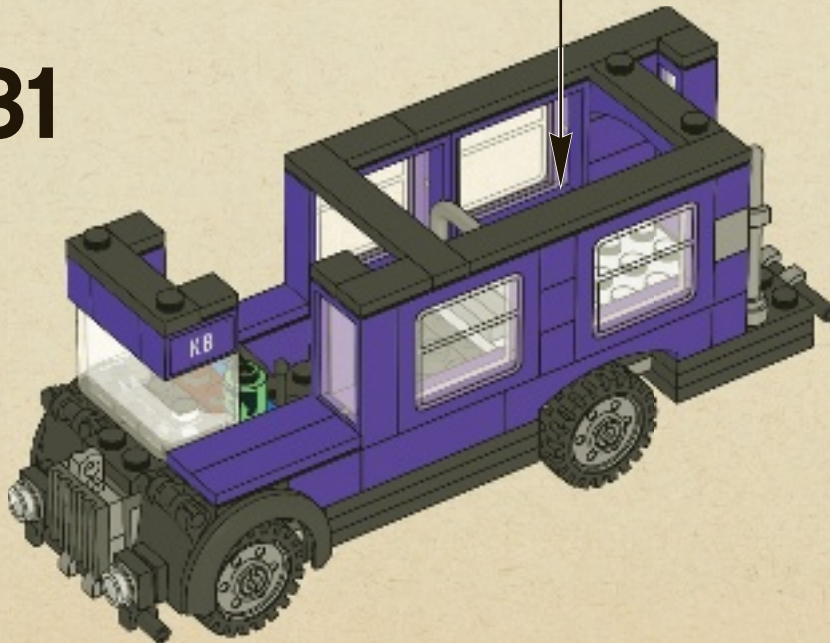

32

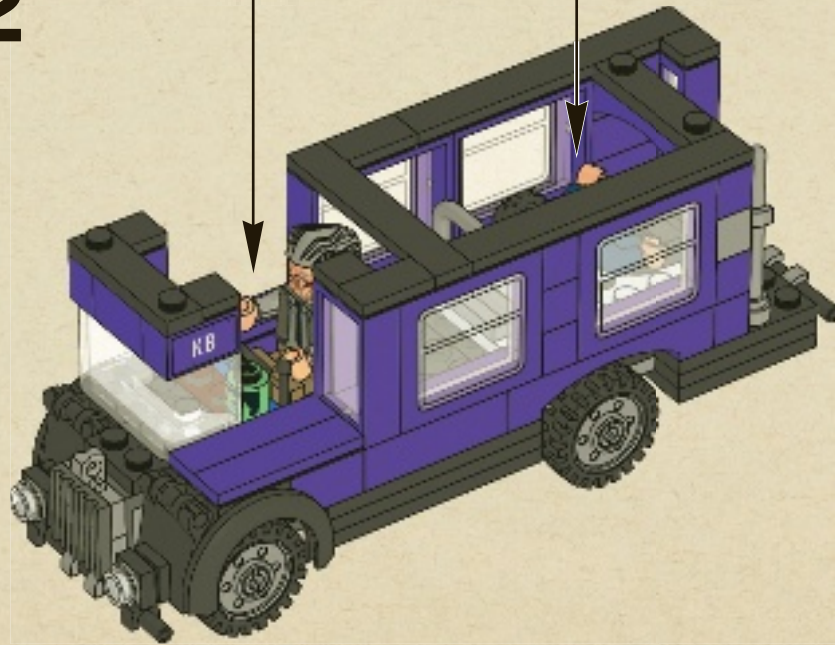

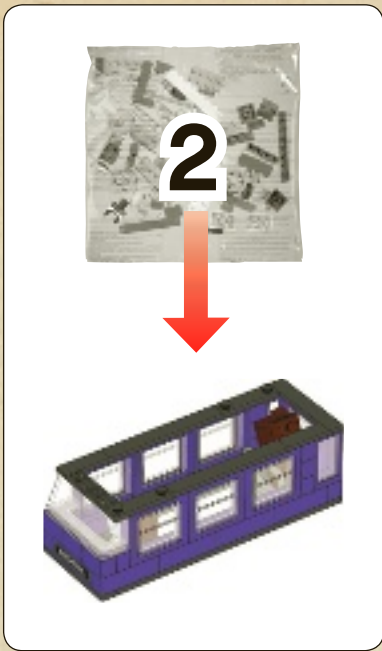

1



2

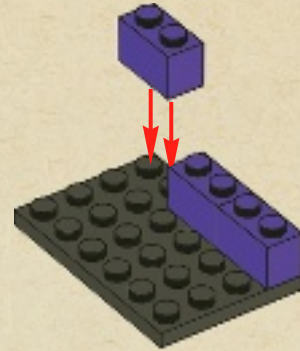

3

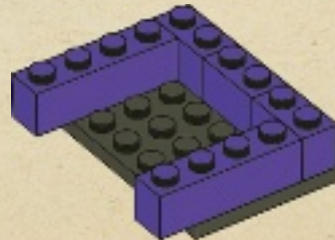



4

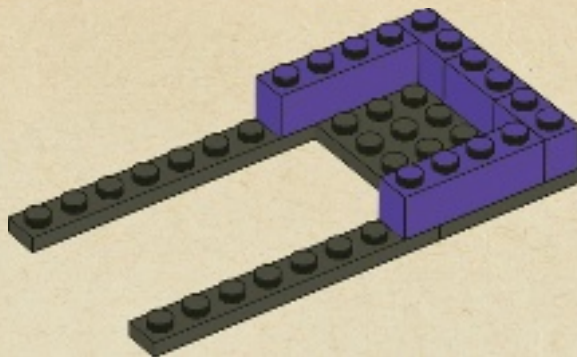

5

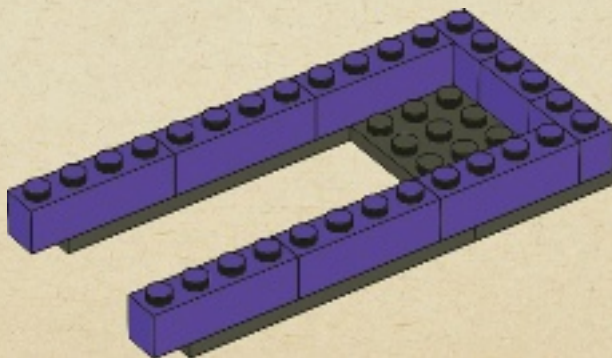

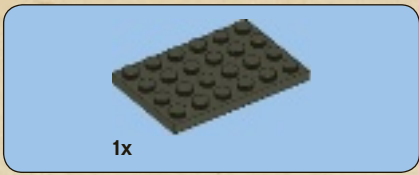

6

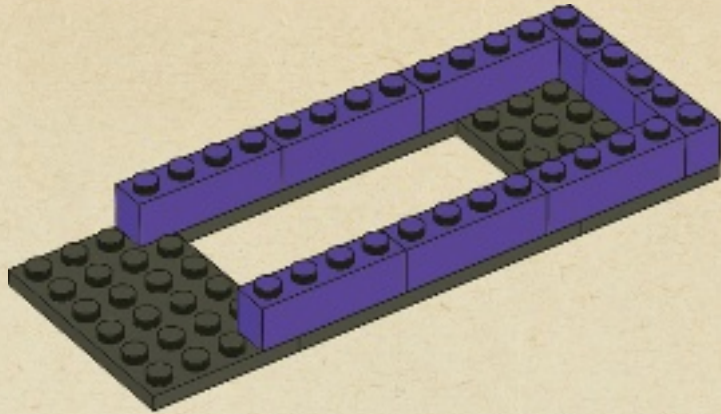

7

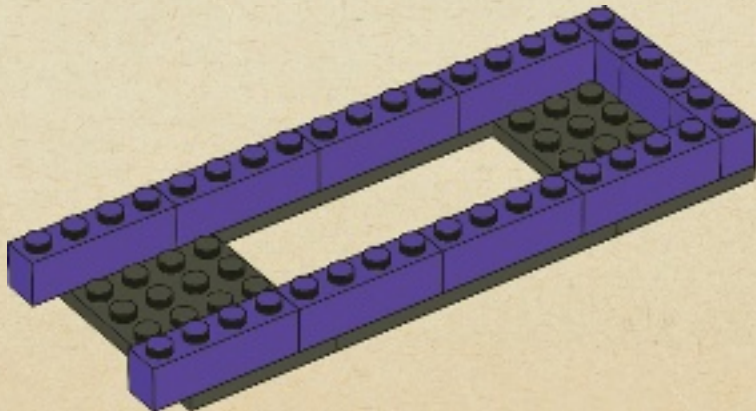



8

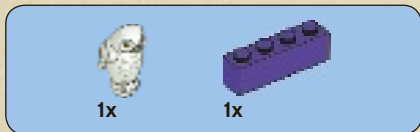
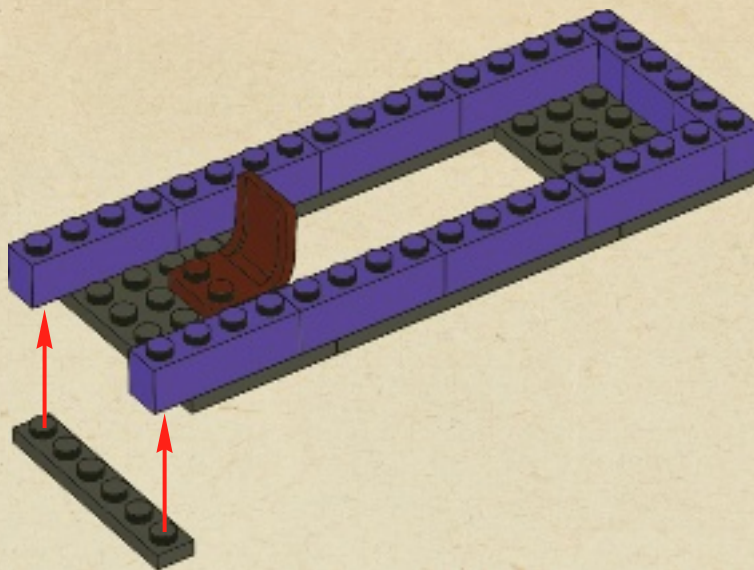

9

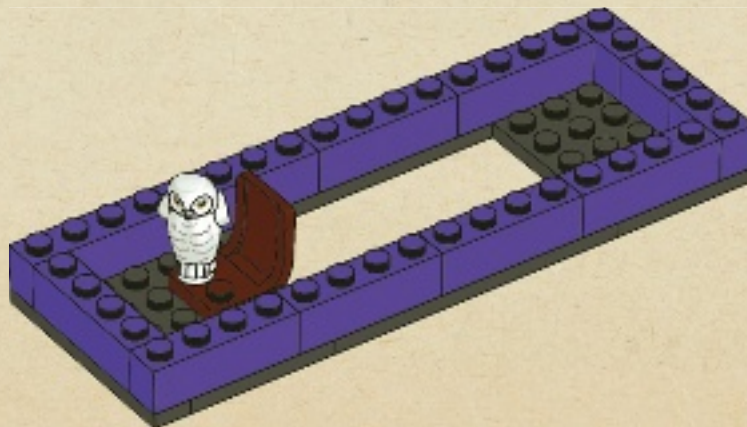

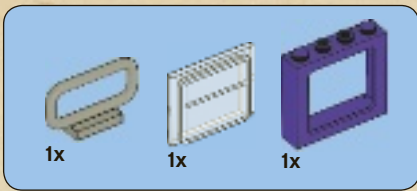

10

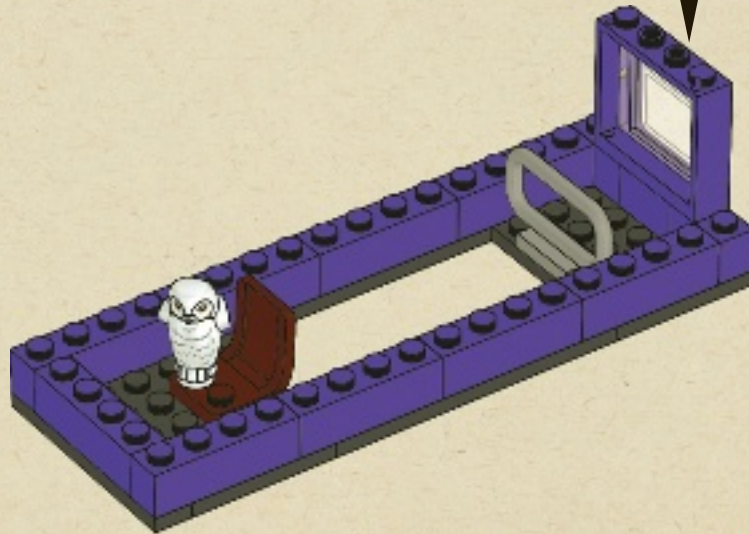
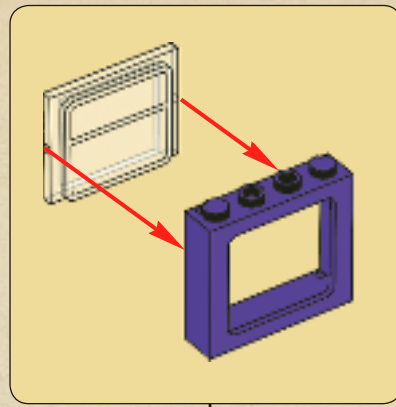

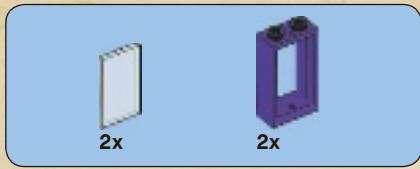

11

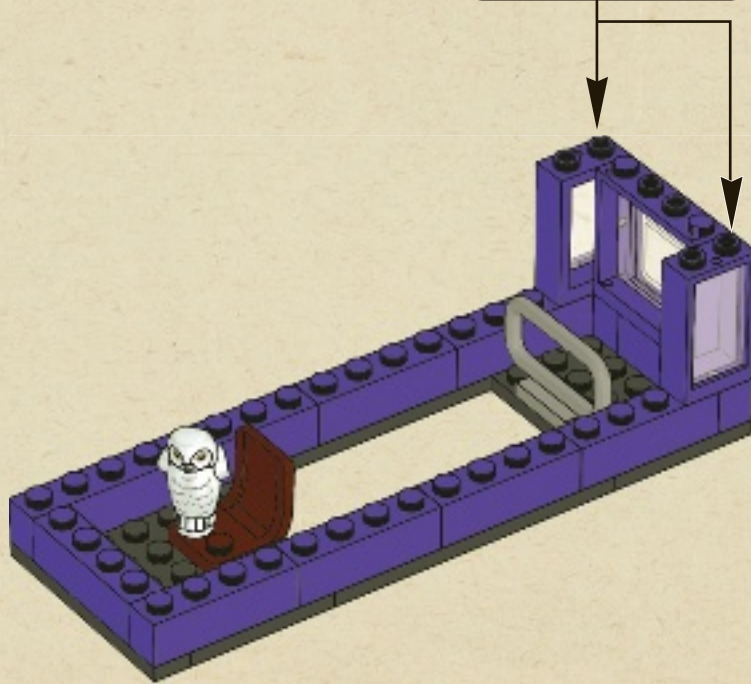
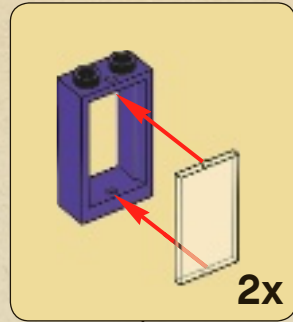



12

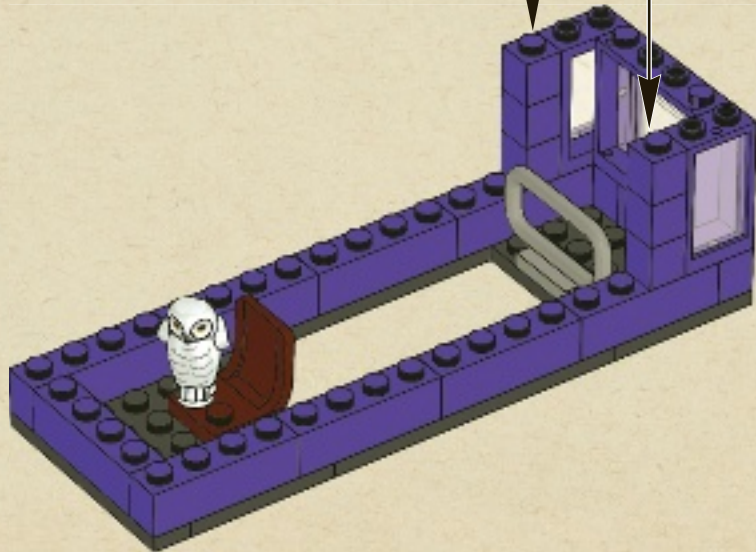
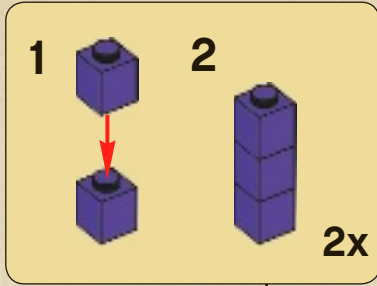

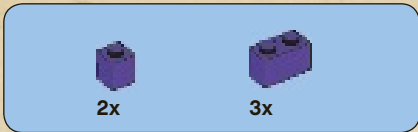

13

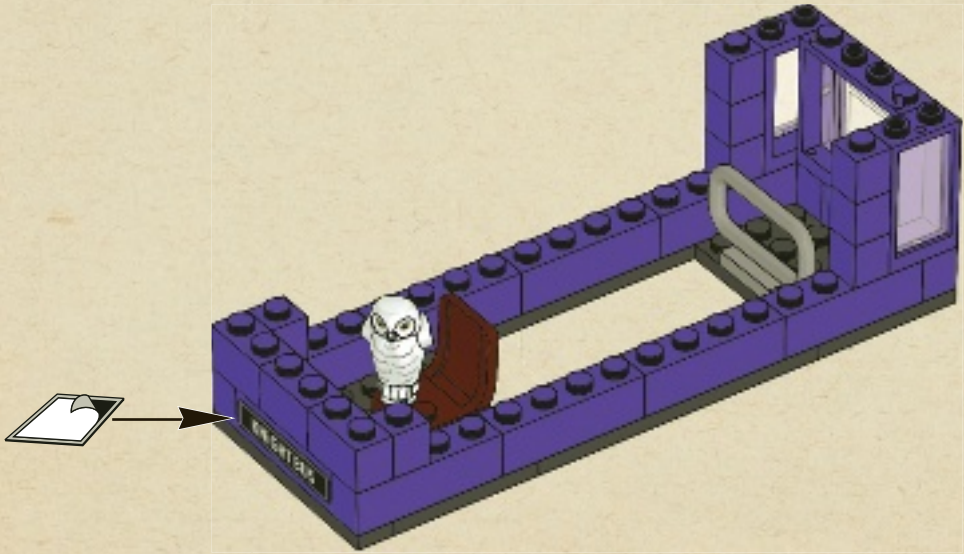

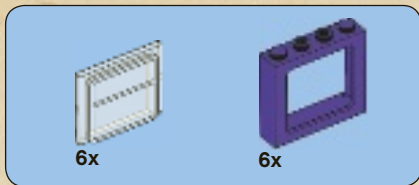

14

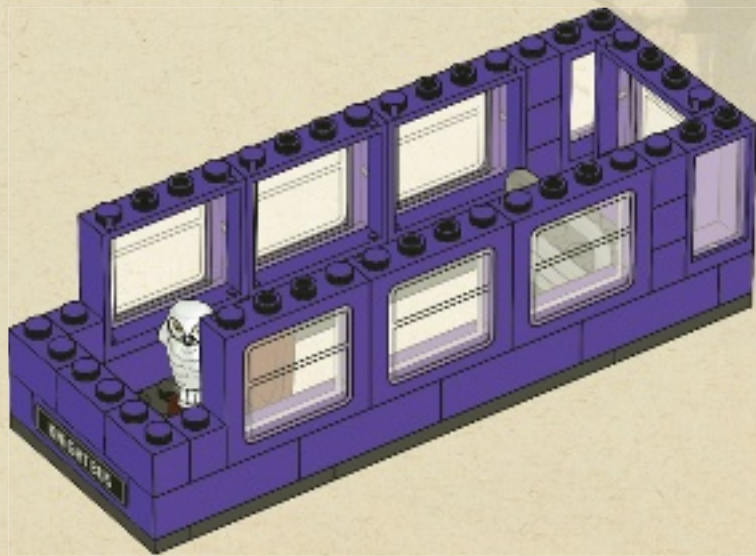



1x

15

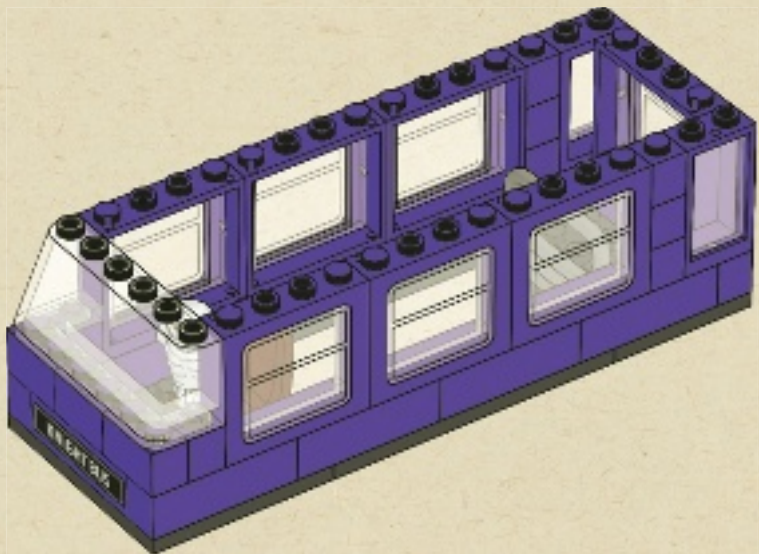

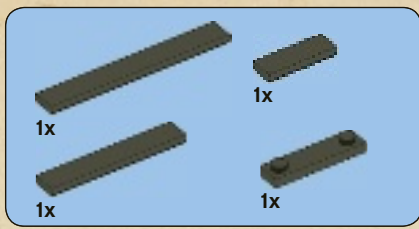

16

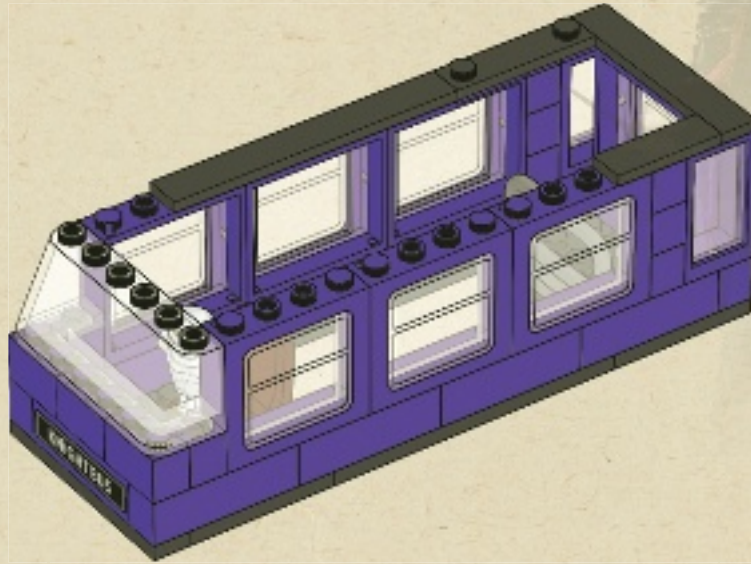

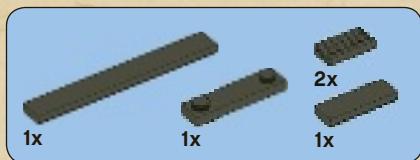

17

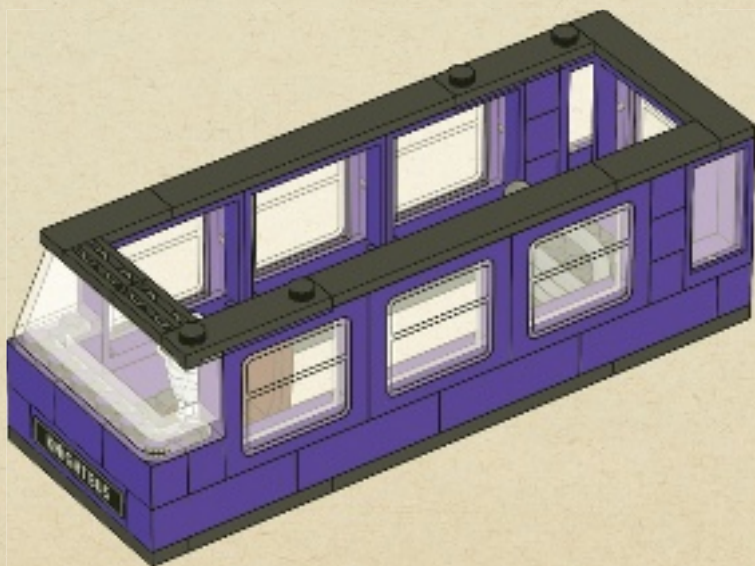

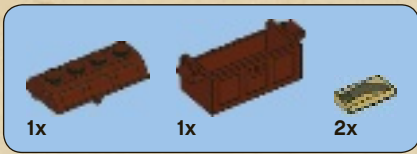

18

1

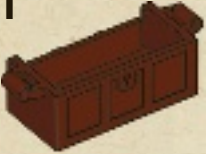

2



3



4

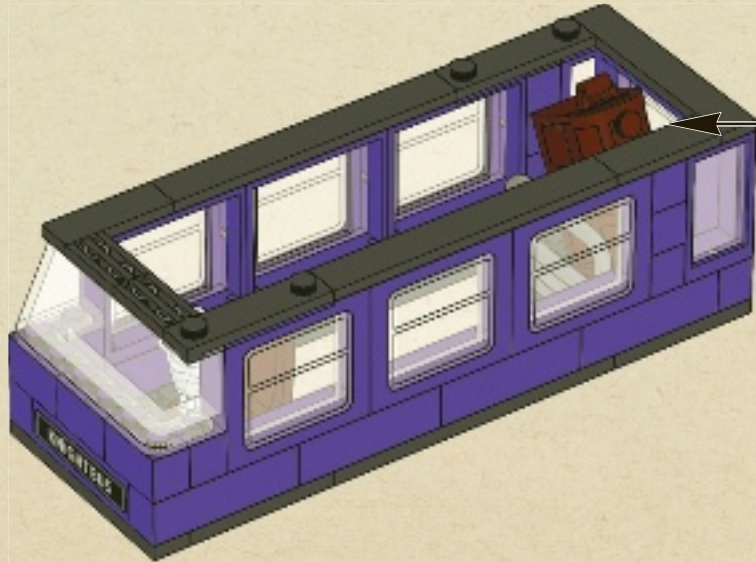

19

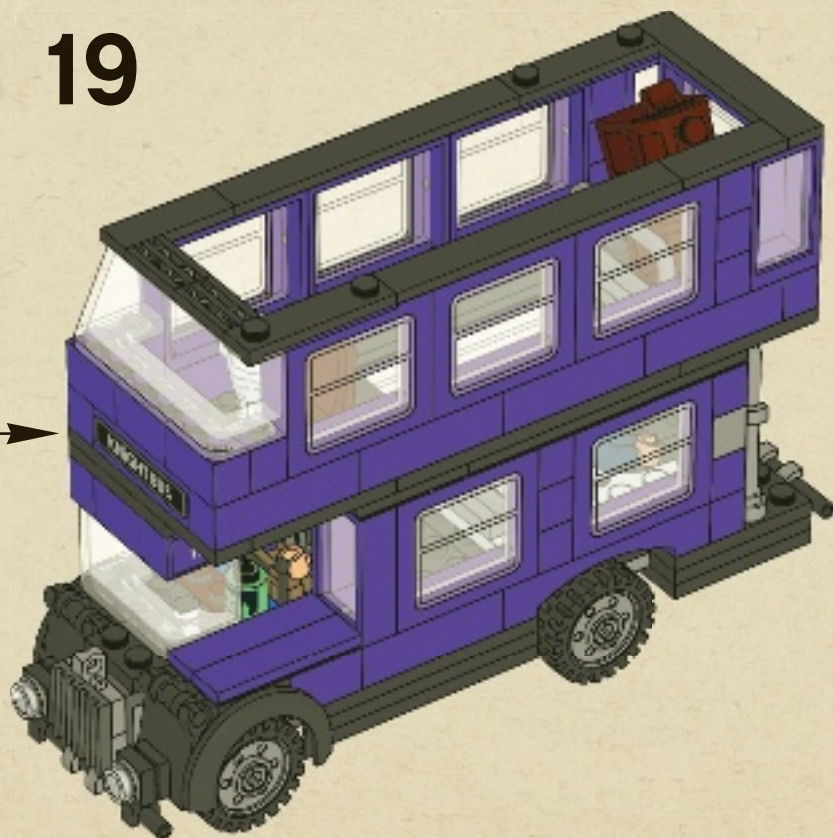

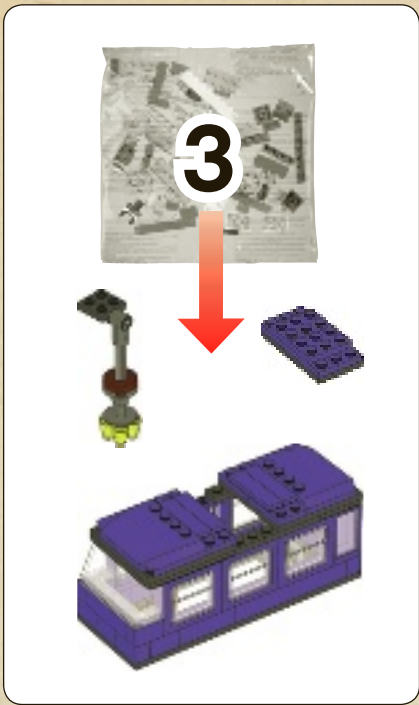

1



2

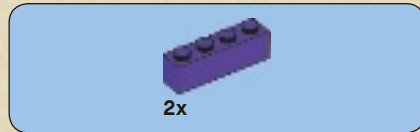
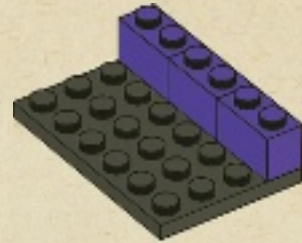

3

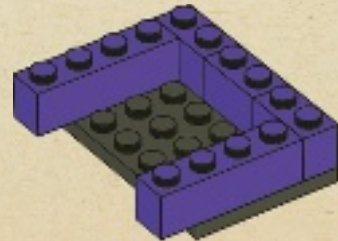



4

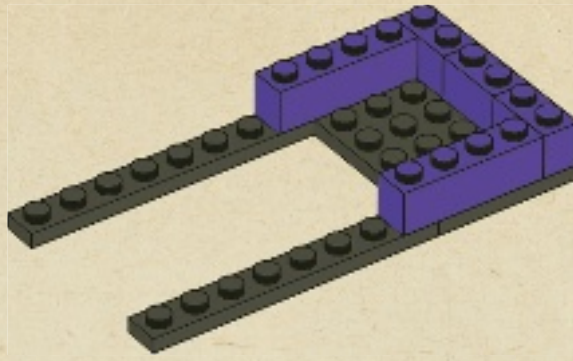

5

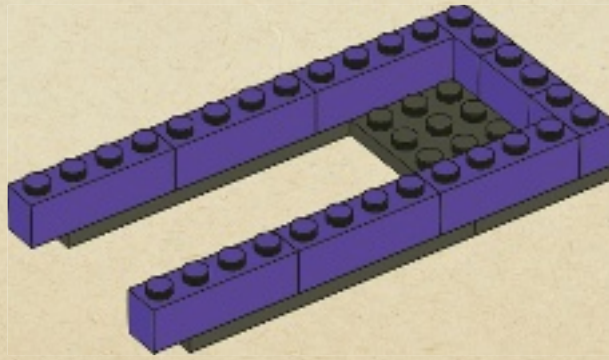

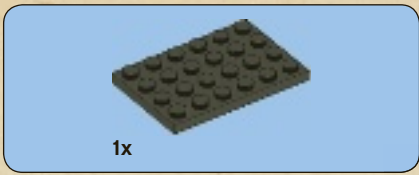

6

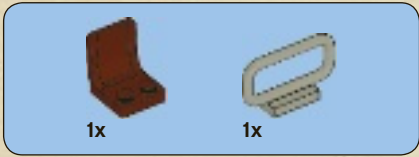
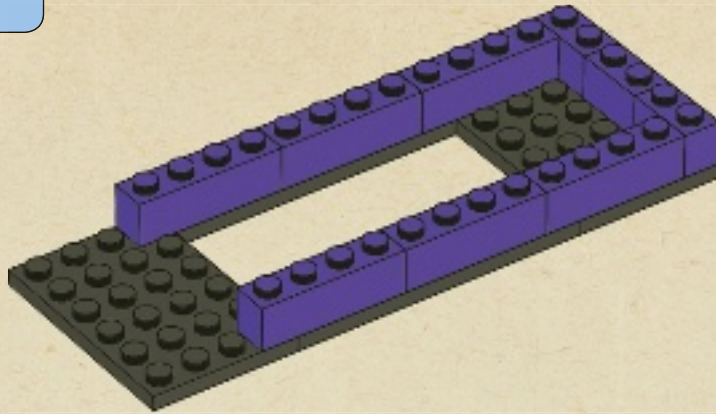

7

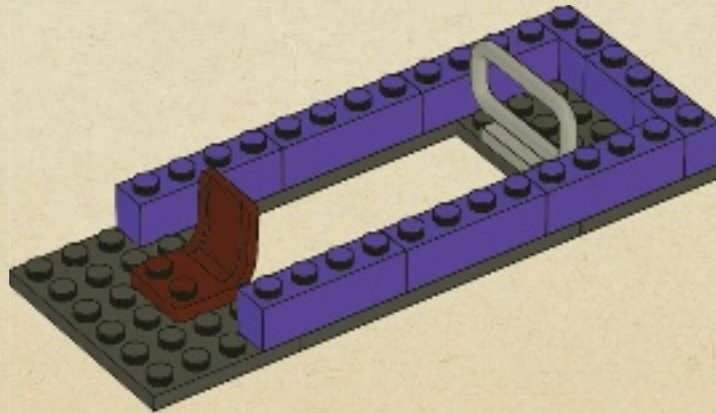



5x

8

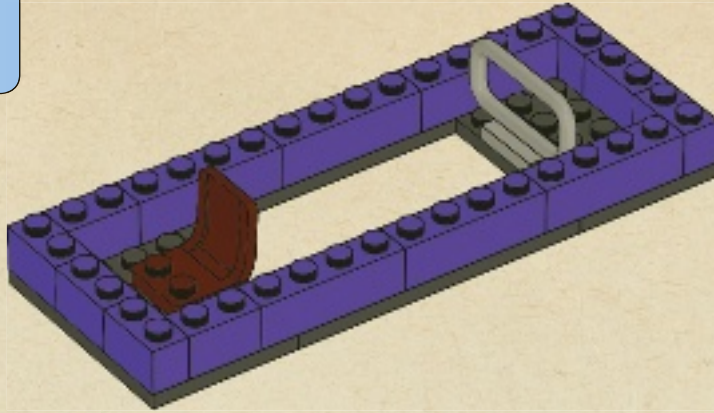

2x



2x



1x

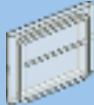

1x

9

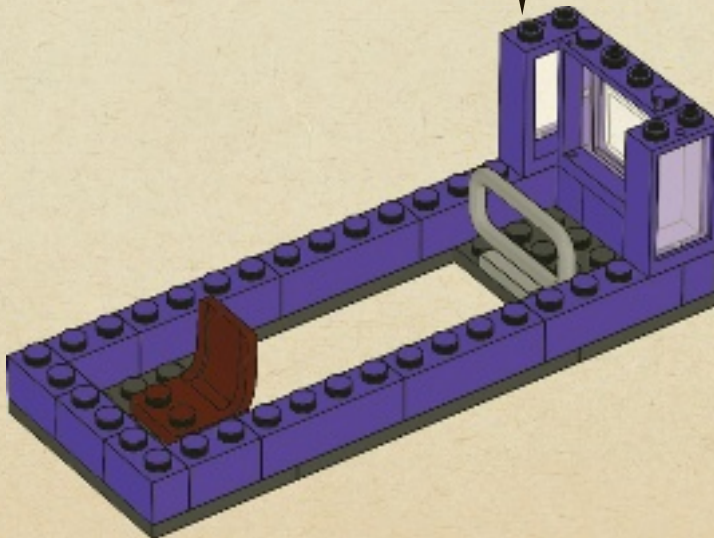

2x

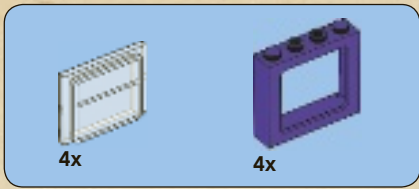

10

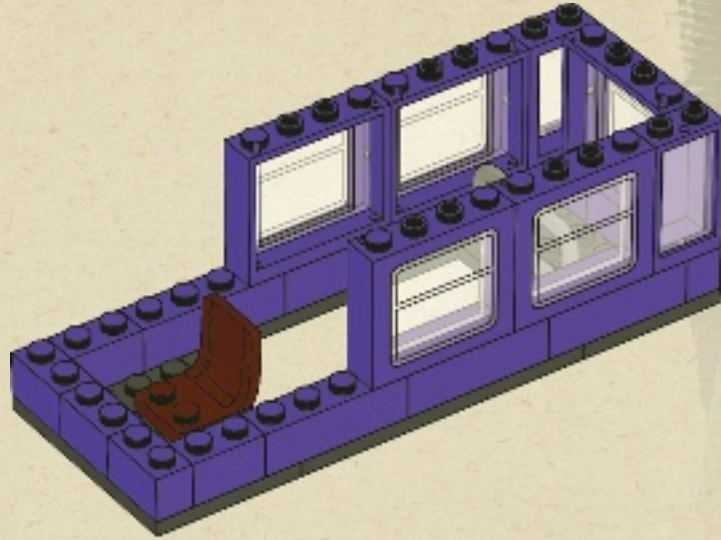

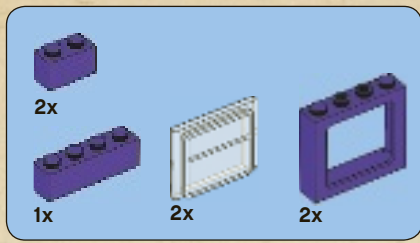

11

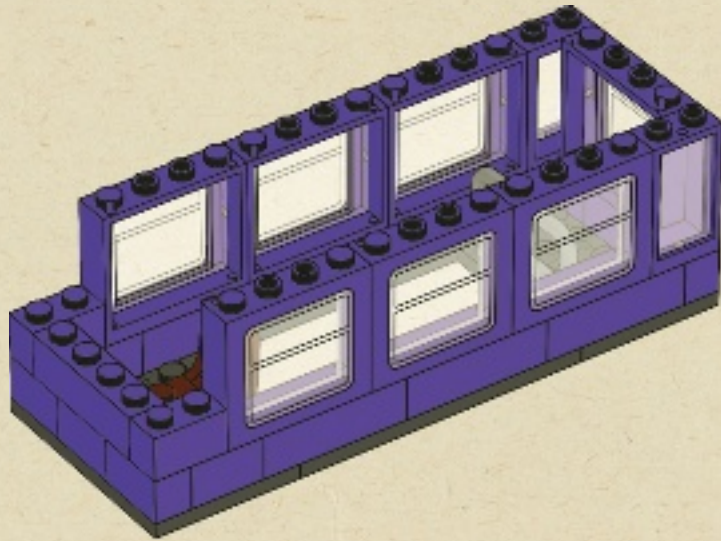

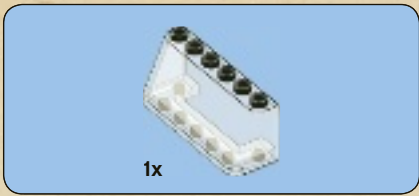

12

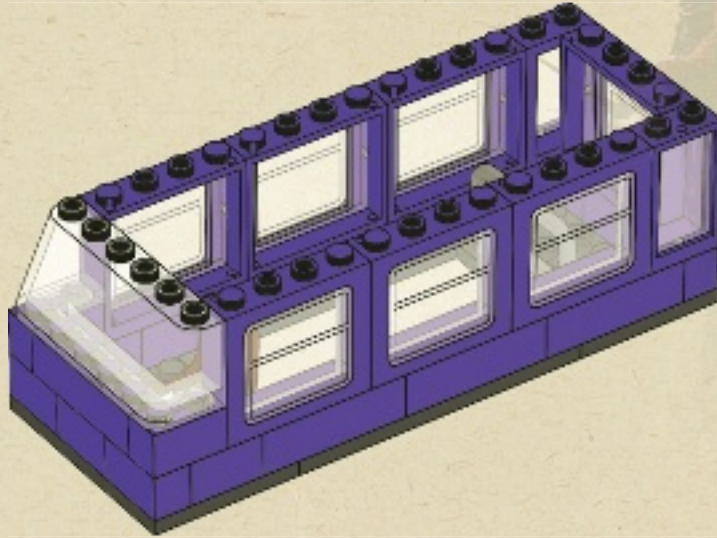

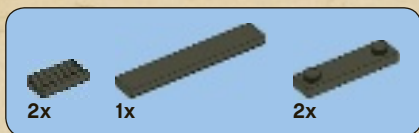

13

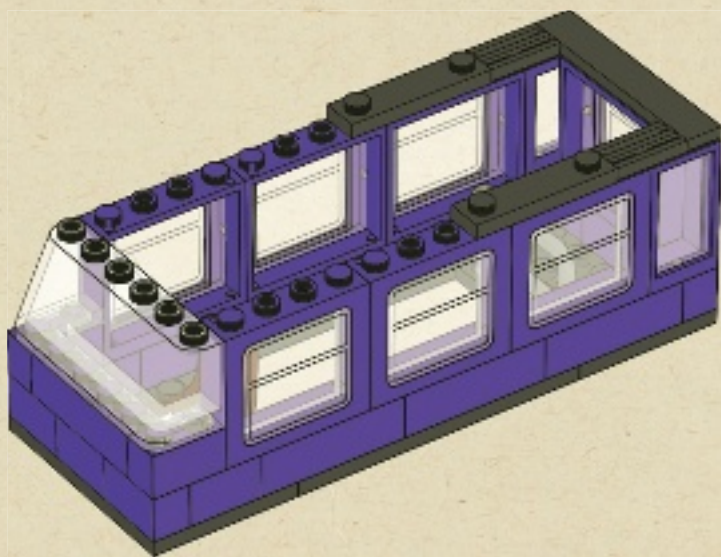

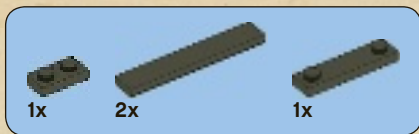

14

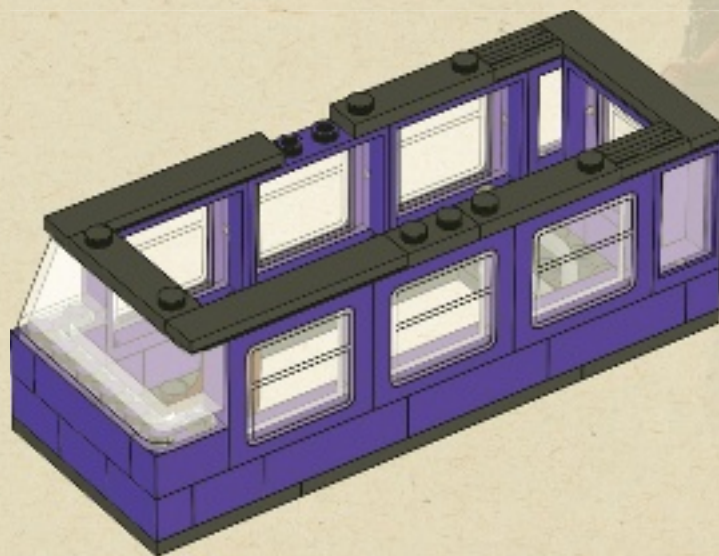

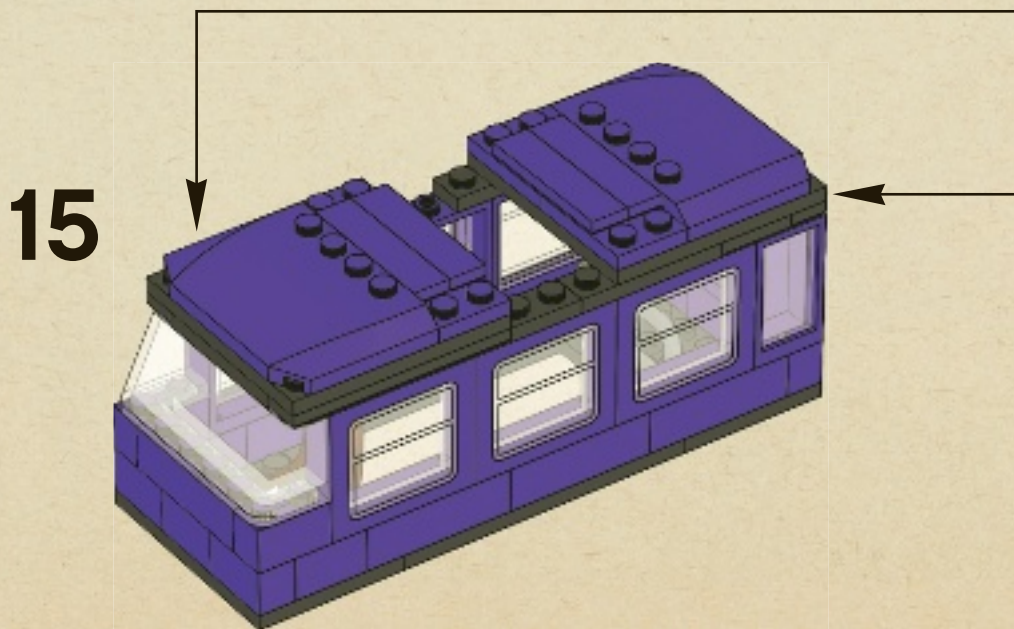
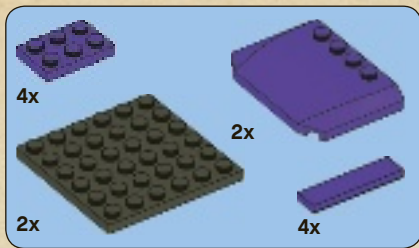

16



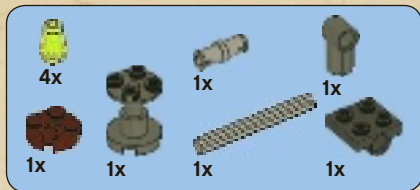

1



2



3



4



5

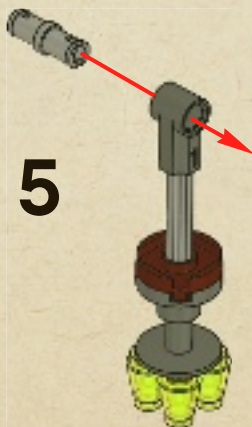

6

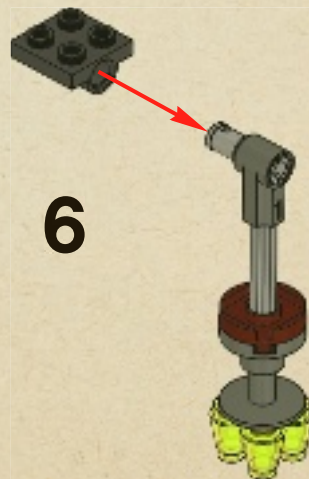

17

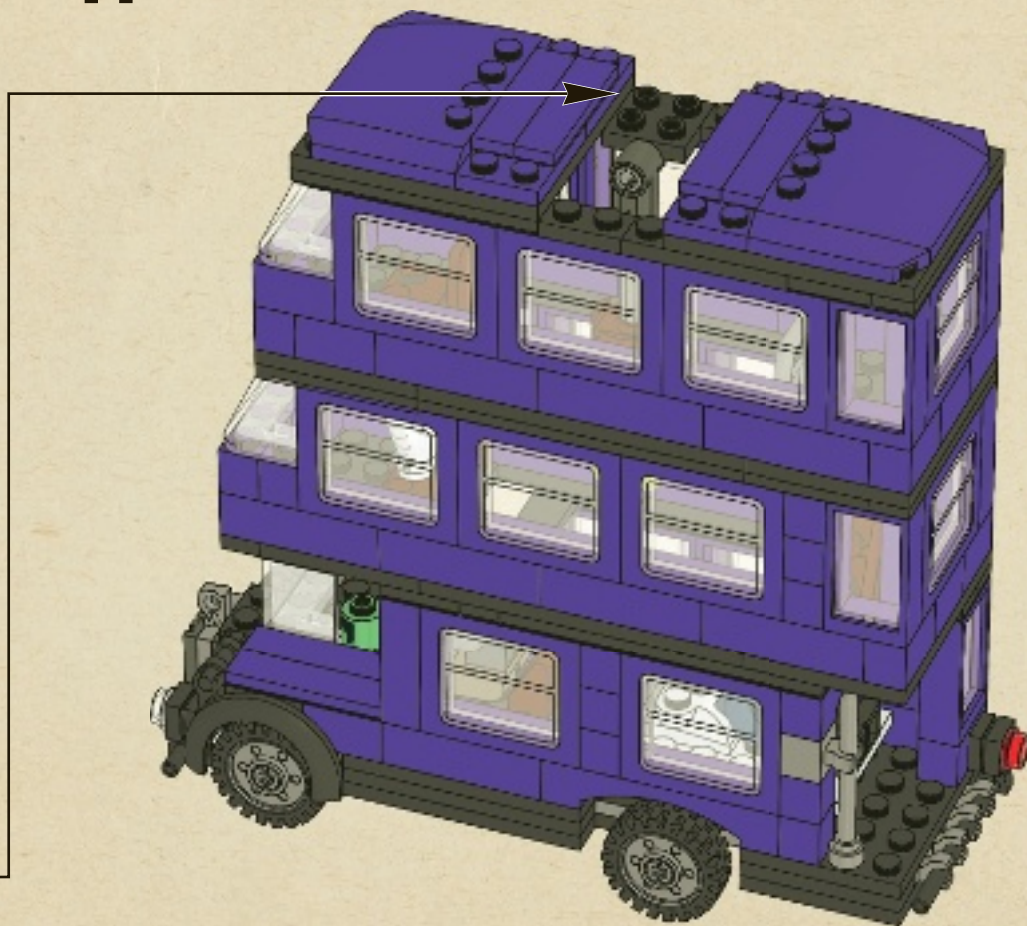



2x

1

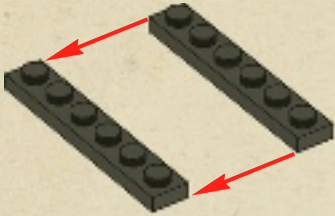

3x

2

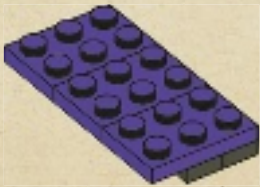

1x

3

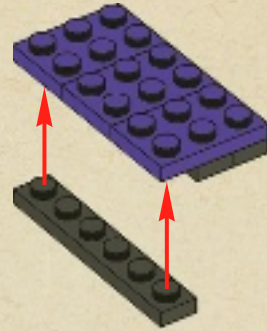

2x

4

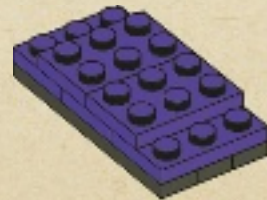

18





1x
303201



1x
4596754



1x
4494474



2x
4613257



1x
4296152



1x
9566



9x
4599499



11x
366626

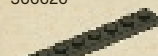

4x
346026



4x
416226



5x
663626



1x
4243819



7x
303226



3x
395826



2x
4260488



7x
307026



2x
306926



1x
302326



1x
302226



4x
4567332



2x
4558170



3x
4517925



4x
241226



2x
4140588



1x
244426



2x
4523405



1x
9339



1x
4157659



4x
4541455



2x
4640742



1x
3005741



1x
4596636



2x
4211190



1x
4211159



2x
4211206



1x
4211163



1x
4533101



1x
4211219



1x
4262974



1x
4211473



2x
4211572



2x
4211406



1x
4211407



1x
4533772



1x
4211814



3x
4556157



3x
4211584



1x
4539887



4x
4499259



1x
4211807



1x
4211639



1x
4211065



1x
4211110



2x
4210631



1x
4277928



1x
4210658



1x
4640594



1x
4586410



1x
4639468



1x
4640741



6x
4640614



16x
4640738



26x
4640739



11x
4225142



7x
4225185



18x
4640611



3x
4640613



18x
4640740



2x
4517749



1x
4638857



1x
4596302



1x
4641424



2x
4113917



2x
4596327



2x
4278422



1x
4641428



1x
4524098



2x
3005740



6x
4536998



18x
403440



1x
4620810



2x
4502193



Customer Service

Kundenservice

Service Consommateurs

Servicio Al Consumidor

www.lego.com/service or dial



00800 5346 5555 :



1-800-422-5346 :



HOGWARTS EXPRESS



3862



4865



4866



4867



4736



4737



4738



4840



4841



4842



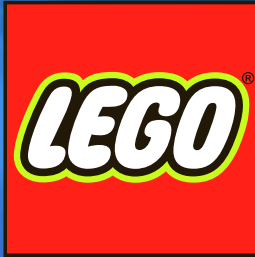

Harry Potter

YEARS 5-7



Wii™

NINTENDO DS™



PlayStation.



™ & © Warner Bros. Entertainment, Inc.
Harry Potter Publishing Rights © J.K. Rowling.
(s11)



Games for Windows



XBOX 360.

XBOX LIVE.



©2011 The LEGO Group. "PlayStation" and the "PS" Family logo are registered trademarks and the PlayStation Network logo is a trademark of Sony Computer Entertainment Inc. Wii and Nintendo DS are trademarks of Nintendo. © 2006 Nintendo, Microsoft, Xbox, Xbox 360, Xbox LIVE, and the Xbox logos are trademarks of the Microsoft group of companies and are used under license from Microsoft. Windows and the Windows Vista Start button are trademarks of the Microsoft group of companies, and "Games for Windows" and the Windows Vista Start button logo are used under license from Microsoft. All other trademarks and copyrights are the property of their respective owners. All rights reserved.
©2011 Le Groupe LEGO. « PlayStation » et le logo « PS » Family sont des marques de commerce et le logo PlayStation Network est une marque de commerce de Sony Computer Entertainment Inc. Wii et Nintendo DS sont des marques de commerce de Nintendo. © 2006 Nintendo, Microsoft, Xbox, Xbox 360, Xbox LIVE, et les logos Xbox sont des marques de commerce du groupe des compagnies Microsoft et sont utilisés sous licence de Microsoft. Windows et le bouton Démarrer Windows Vista sont des marques de commerce du groupe des compagnies Microsoft, et « Games for Windows » et le logo du bouton Démarrer Windows Vista sont utilisés sous licence de Microsoft. Toutes les autres marques de commerce et droits d'auteur sont la propriété de leurs propriétaires respectifs. Tous droits réservés.
©2011 The LEGO Group. "PlayStation" y el Logo de la familia "PS" son marcas registradas y el logo de PlayStation Network es marca registrada de Sony Computer Entertainment Inc. Wii y Nintendo DS son marcas registradas de Nintendo. © 2006 Nintendo, Microsoft, Xbox, Xbox 360, Xbox LIVE, y los logos Xbox son marcas registradas del grupo de compañías Microsoft y son usadas bajo licencia de Microsoft. Windows y el botón de inicio Windows Vista son marcas registradas del grupo de compañías Microsoft, y Games for Windows y el logo del botón de inicio Windows Vista son usados bajo licencia de Microsoft. Todas las demás marcas registradas y copyrights son propiedad de sus respectivos dueños. Todos los derechos reservados.

LEGO club
FREE! GRATIS! GRATUIT!



www.LEGOclub.com



LEGO Club Magazine



LEGO Club Email

VISIT THE WORLD'S
BIGGEST LEGO SHOP!

www.LEGOshop.com

00800 5346 5555

1-866-534-6258 • 1-877-518-5346

US & Canada only

Outside the US



- * Freephone. Mobile charges may apply.
- * Numéro sans frais. Des frais peuvent s'appliquer avec les téléphones cellulaires.
- * Gebührenfrei, Kosten für Anrufe aus Mobilfunknetzen können abweichen.
- * Gratis telefonnummer vanaf vaste lijn.
- * Det er et gratis nummer, når du ringer fra fasttelefon.
- * Det är gratis, när du ringer från en fast telefon.
- * Numéro sans frais. Des frais peuvent s'appliquer avec les téléphones portables.

BI115

YES! I want to join the LEGO® Club FREE! **OUI!** Je veux m'abonner au LEGO® Club GRATUITEMENT !

Ja! Ich möchte Mitglied im kostenlosen LEGO® Club werden. **Ja!** Ik wil graag GRATIS lid worden van de LEGO® Club. **Ja!** Jeg ønsker å melde meg inn i LEGO® Club gratis! **Ja!** Jag vill gå med i LEGO® Club GRATIS!

First name • Prénom
Vorname • Voornaam
Fornavn • Fornamn

Last name • Nom de famille
Name • Achternaam
Etternavn • Etternavn

Date of Birth • Date de naissance
Geburtsdag • Geboortedatum
Fødselsdato • Födelsedatum

Boy • Garçon
Junge • Jongen
Gutt • Pojk

Girl • Fille
Mädchen • Meisje
Jente • Flicka

Street • Adresse
Straße, Hausnr.
Straat, huisnr. • Address

City • Ville
Ort • Woonplaats
Poststed • Postort

State
Prov.
County

Zip/Postcode
Code Postal • PLZ
Postcode
Postnummer

Country
Pays
Land

Email • Courriel
E-Mail • E-post

- Fill in your email address and we will send you a membership confirmation and monthly email newsletters. If you do not wish to receive the newsletters please tick here. Remplis ton adresse e-mail et nous t'enverrons une confirmation d'adhésion ainsi que le bulletin e-mail mensuel. Si tu ne désires pas recevoir le bulletin, coche cette case. Vul je e-mailadres in en we sturen je een bevestiging van je lidmaatschap en maandelijke e-mail nieuwsbrieven. Als je geen e-mail wilt ontvangen, kruis dan dit vakje aan.
- Ich möchte per E-Mail den monatlichen LEGO Club Newsletter erhalten. Ønsker du at vi skal sende en liten hilsen til barnet ditt for å bekrefte medlemskapet, ber vi deg krysse av i feltet, samt oppgi e-postadressen som hilsenen skal sendes til. Om du vill att vi ska skicka en bekräftelse på ditt barns medlemskap, ber vi dig sätta ett kryss i rutan och skriva den e-post address som bekräftelsen ska skickas till.
- If you do not wish to receive additional mailings from the LEGO Club please tick here. Si tu ne désires pas recevoir de courrier supplémentaire du Club LEGO, coche cette case. Als je geen verdere post van de LEGO Club wilt ontvangen, kruis dan dit vakje aan.
- Dersom du ønsker å motta annen informasjon fra LEGO Gruppen, setter du et kryss her.

Mail to: / Poster à: **LEGO® Club**
P.O. Box 1157
Enfield, CT USA
06083-1157

Per Post an: **LEGO® Club**
Postfach 14 15
D-36243 Niederaula

Send til: **LEGO® Club Norge**
Postboks 58
1314 Vøyenenga

Mail to: **LEGO® Club**
33 Bath Road
Slough SL1 3UF
United Kingdom

Stuur na naar: **LEGO® Club**
Postbus 40250
3504 AB Utrecht

Skickas till: **LEGO® Club Sverige**
Ubox 841
202 29 Malmö

Poster à: **LEGO® Club**
21 rue de la banque
75 002 PARIS
FRANCE

The English language version of the magazine can only be mailed to addresses in the US, Canada, the UK, and Republic of Ireland. Club membership is valid for two years and includes free copies of the LEGO Club Magazine and e-mail newsletters. In the US and Canada please allow up to 6 weeks for delivery of your first magazine. In the UK and Republic of Ireland please allow six to 14 weeks for delivery of your first magazine. By signing this form you consent the LEGO Club to use your child's data for LEGO mailings. The data will only be used for LEGO mailings and will not be sold, rented or otherwise disclosed to any company outside the LEGO Company except for disclosure to companies acting as our agents to help us provide services requested by the child. This coupon is valid for one free membership per person, group or organization. Photocopied coupons are accepted. La version française du magazine peut être postée uniquement au Canada. L'abonnement est valide pour 2 ans et inclut des exemplaires gratuits du Magazine LEGO. Aux É.U. et au Canada, allouer 6 semaines pour la livraison initiale. En remplissant ce formulaire, vous consentez à ce que LEGO utilise les informations de votre enfant pour des envois postaux de LEGO. L'information sera utilisée uniquement pour des envois postaux par LEGO et ne sera en aucun cas, vendue, louée, échangée ou divulguée à d'autres compagnies autres que la compagnie LEGO, à l'exception des compagnies affiliées qui nous procurent des services auxquels l'enfant en a fait la demande. Formulaire photocopiés acceptés. Mit der folgenden Unterschrift erkläre ich, für mein Kind den Beitritt zum kostenlosen LEGO Club, der von der LEGO GmbH, D-85629 Grasbrunn, betrieben wird. Die Mitgliedschaft beinhaltet die Zusendung des LEGO Club Magazines und kann beiderseits jederzeit beendet werden. Mit der Mitgliedschaft im LEGO Club sind keinerlei Verpflichtungen verbunden. Das deutschsprachige LEGO Club Magazin wird nur an Adressen in Deutschland, Österreich und der Schweiz versendet. Eine Anmeldebestätigung kann nur per E-Mail geschickt werden. Das Magazin erscheint fünfmal jährlich. Daher kann die Zustellung des ersten Heftes bis zu drei Monate dauern. Die Mitgliedschaft ist beidseitig jederzeit kündbar, ohne dass Ihnen Kosten entstehen. Sie können der werblichen Nutzung Ihrer Daten jederzeit widersprechen. Kündigung und Widerspruch können Sie telefonisch erklären (00800 / 5346 5555, Anruf gebührenfrei, Kosten für Anrufe aus dem Mobilfunknetz können abweichen) oder an die LEGO GmbH senden. Het Nederlandse LEGO Club Magazine kan alleen worden gestuurd naar adressen in Nederland. Het lidmaatschap is 2 jaar geldig en geeft recht op toezending van het gratis LEGO Club Magazine en LEGO Club e-mails. Het eerste magazine gaat binnen 12 tot 14 weken toegestuurd worden. Het lidmaatschap kan op ieder moment opgezegd worden en kan na 2 jaar gratis worden verlengd, tenzij LEGO met deze activiteit stopt. Uw gegevens worden uitsluitend gebruikt voor mailings van LEGO en zullen niet worden verkocht, verhuurd of op welke wijze dan ook verstrekt aan derden buiten de LEGO Groep, uitgezonderd de organisaties die namens ons optreden om de informatie te sturen waarvoor toestemming is verleend. Den norske utgaven av magasinet sendes kun til adresser i Norge. Medlemskap i klubben gjelder 12 år og inkluderer gratisutgaver av LEGO Club Magazine. Prøven minimum oppsett seks uker leveringstid for første magasin. Ved å undertegne dette skjemaet, gir du ditt samtykke til at LEGO Club kan bruke opplysningene om barnet ditt i LEGO forsendelser. Dataene vil utelukkende bli brukt i LEGO forsendelser og vil ikke bli solgt, utleid eller på annen måte gjøres tilgjengelig for selskaper utenfor LEGO gruppen, unntatt selskaper som er våre agenter og som hjelper oss å tilby tjenestene barnet etterper. Dette skjemaet gjelder for ett gratis medlemskap per person, gruppe eller organisasjon. Den svenska versionen av tidningen kan endast skickas till adresser i Sverige. Club-medlemskapet är giltigt i 2 år och innefattar gratis exemplar av LEGO Club Magazine. Vänligen räkna med minimum 6 veckor för leverans av din första tidning. Genom att skicka in det här formuläret godkänner du att LEGO Club använder barnets uppgifter för LEGO utskick. Uppgifterna kommer bara att användas för LEGO utskick och kommer inte att säljas, hyras ut eller vidarebefordras till något företag som inte tillhör LEGO Gruppen, med undantag av företag som agerar som våra ombud för att tillhandahålla tjänster som barnet har begärt. Den här kupongen gäller för ett gratis medlemskap per person, grupp eller organisation. En complétant ce bulletin d'adhésion, vous acceptez que LEGO Club utilise les données relatives à votre enfant pour l'envoi de courriers concernant LEGO. Ces données seront uniquement utilisées pour l'envoi d'information concernant LEGO et ne seront ni vendues, ni louées, ni utilisées par d'autres sociétés que le groupe LEGO, à l'exception des sociétés agissant pour le compte de LEGO en tant que sous-traitant de services divers. L'abonnement au LEGO Club est valable pour deux années. Ce bulletin d'adhésion est valable pour l'inscription d'une seule personne. Les photocopies sont acceptées. ATTENTION! Le bulletin d'adhésion doit être rempli et signé par un parent ou un tuteur.

Parent's signature • Signature d'un parent ou d'un tuteur •
Unterschrift Erziehungsberechtigter • Handtekening ouders •
Foreldres/foresattes underskrift • Förälders förmyndares underskrift

Date
Datum
Date



WIN!

Go to www.LEGOsurvey.com/product
to fill out a survey for a chance
to win a cool LEGO® Product.

No purchase necessary.

Open to all residents where not prohibited.



www.LEGO.com



www.LEGOsurvey.com/product

GEWINNE! WIN!

Nimm an der Umfrage auf
www.LEGOsurvey.com/product
teil und hab die Chance ein cooles
LEGO® Produkt zu gewinnen!

Die Teilnahme am Gewinnspiel führt zu keinerlei
Kaufverpflichtungen. Teilnahme in allen nicht
ausgeschlossenen Ländern möglich.

Ga naar www.LEGOsurvey.com/product,
vul een enquêteformulier
in en maak kans op een
cool LEGO® product.

Geen aankoopverplichting.
Iedereen mag deelnemen, uitgezonderd
ingezetenden van landen waar een
enquêteverbod geldt.

GAGNE! 当てよう!

Visite www.LEGOsurvey.com/product
pour répondre à un
questionnaire et avoir une chance de
gagner un produit LEGO® très cool!

Aucune obligation d'achat.
Ouvert à tous les résidents des pays
autorisés.

www.LEGOsurvey.com/product にアクセスして、
アンケートにご記入ください。当選者にはレゴ
製品を差し上げます。

お買い上げの必要はありません。
禁止されていない限り、すべての皆様にご利用いただけます。

LEGO, the LEGO logo and the MiniFigure are trademarks of the/sonit des marques de commerce de/son marcas registradas de LEGO Group.
©2011 The LEGO Group. HARRY POTTER, characters, names and related indicia are trademarks of and © Warner Bros. Entertainment Inc.

Harry Potter Publishing Rights © JKR. HARRY POTTER et tous les personnages et éléments qui y sont associés sont des marques de commerce et © de Warner Bros.
Entertainment Inc. Derechos de publicación de Harry Potter © JKR. HARRY POTTER, sus personajes, nombres, y los símbolos son marcas y © de Warner Bros.

Derechos de publicación de Harry Potter © JKR.



WB SHIELD: TM/MC & © Warner Bros. Entertainment Inc.

(s11)