

CREATOR

5771

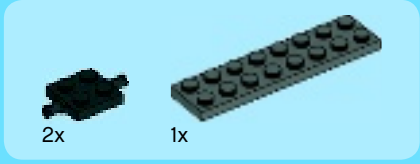



1

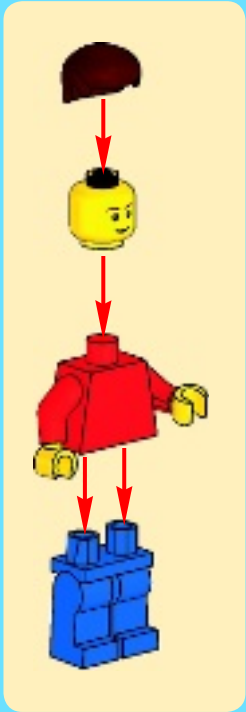

2





2x

3



1x



1x



1x



1x

4

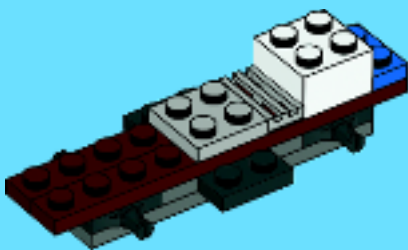

4x



1x

5

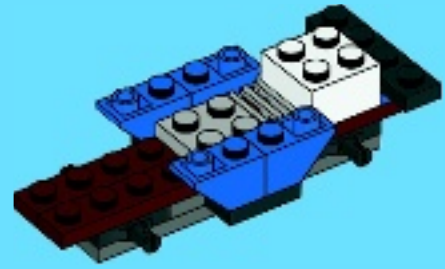

1x



1x



1x

6

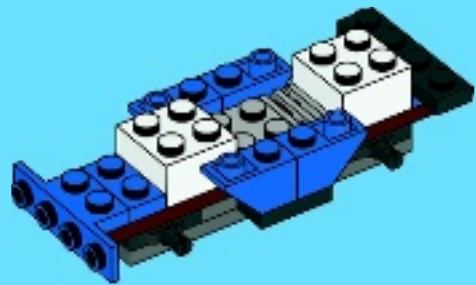

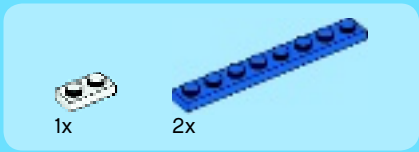

7

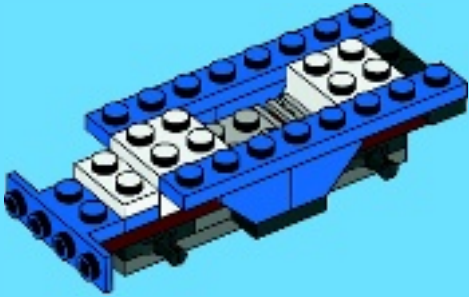

8

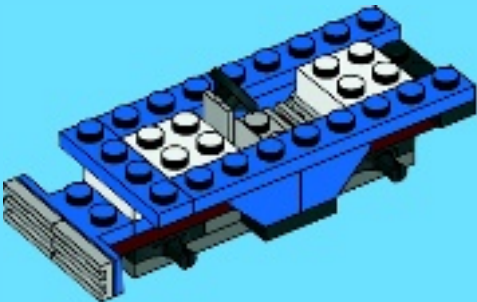

9

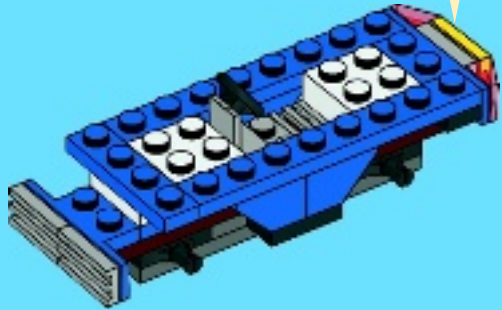
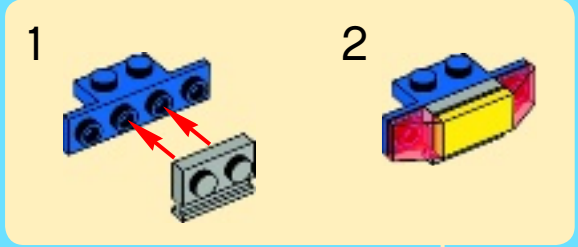

10

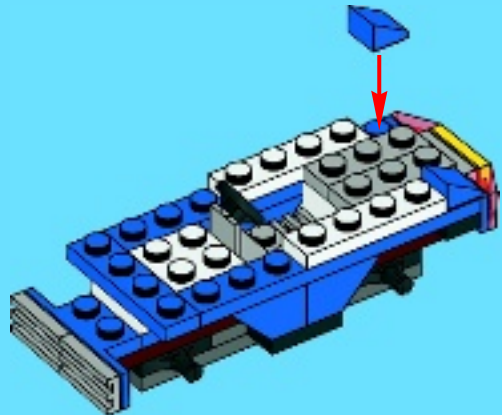



2x



2x



1x

11

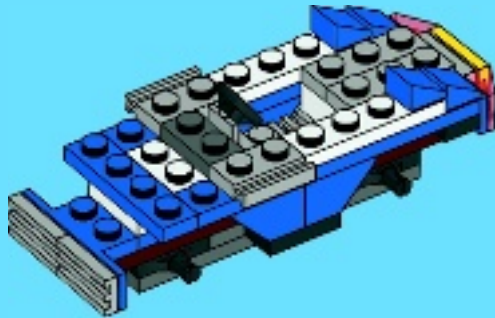

2x



1x

12

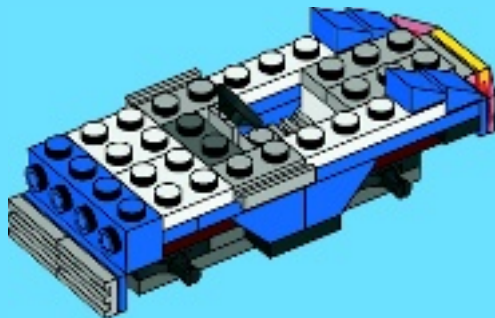

1x



2x



1x

13

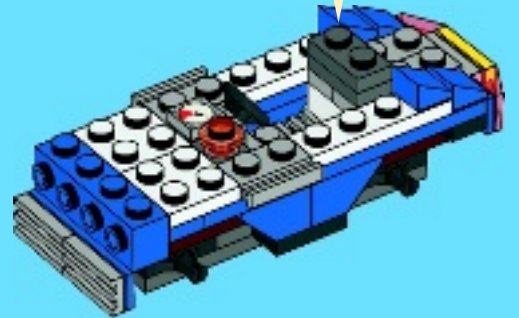
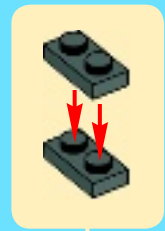

2x



1x



1x

14

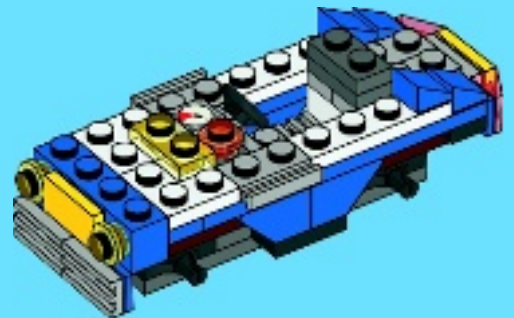



15

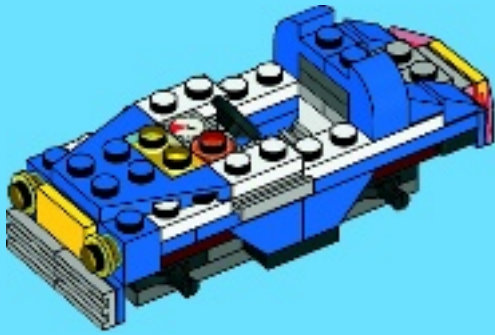

16

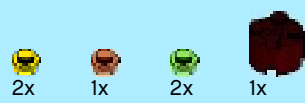
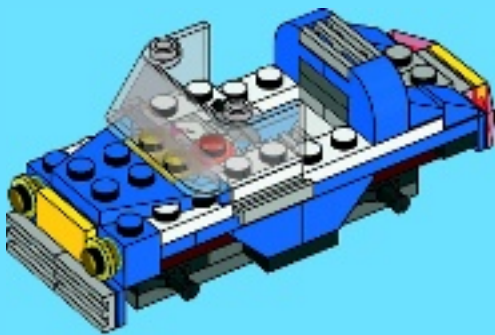

17

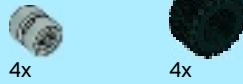
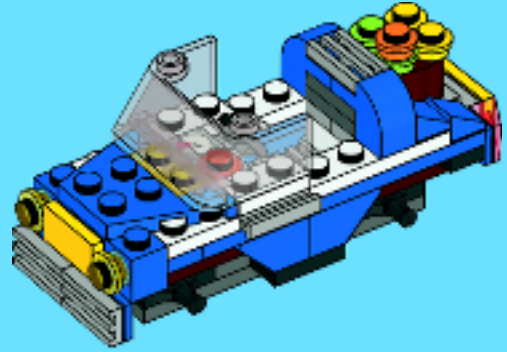

18

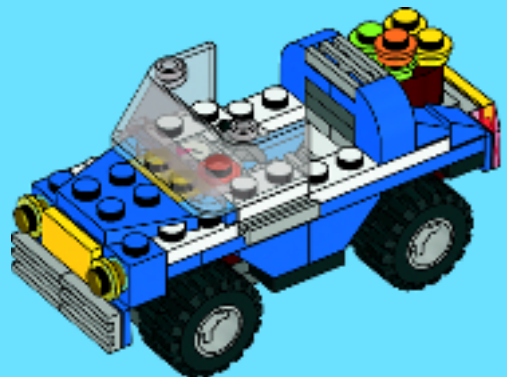



1

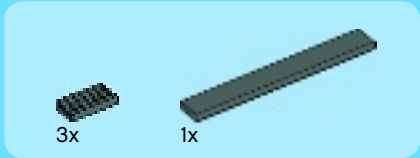
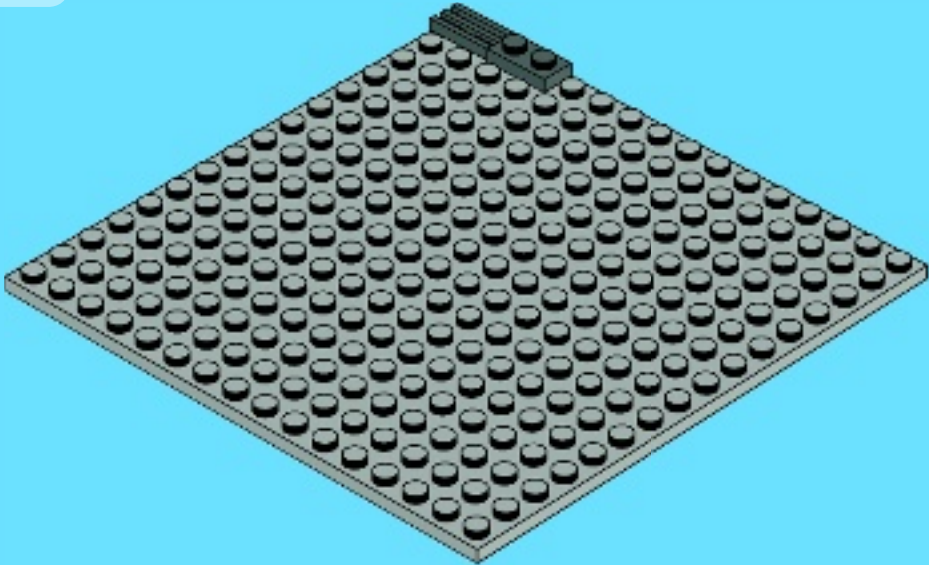

2

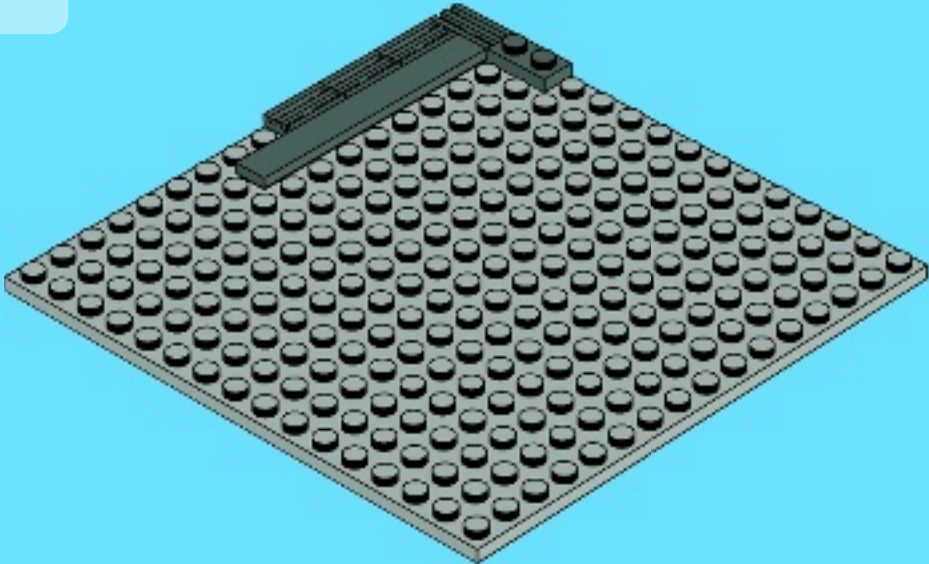

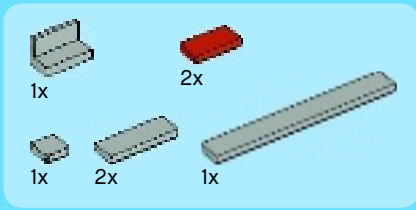

3

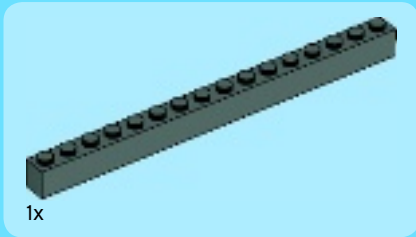
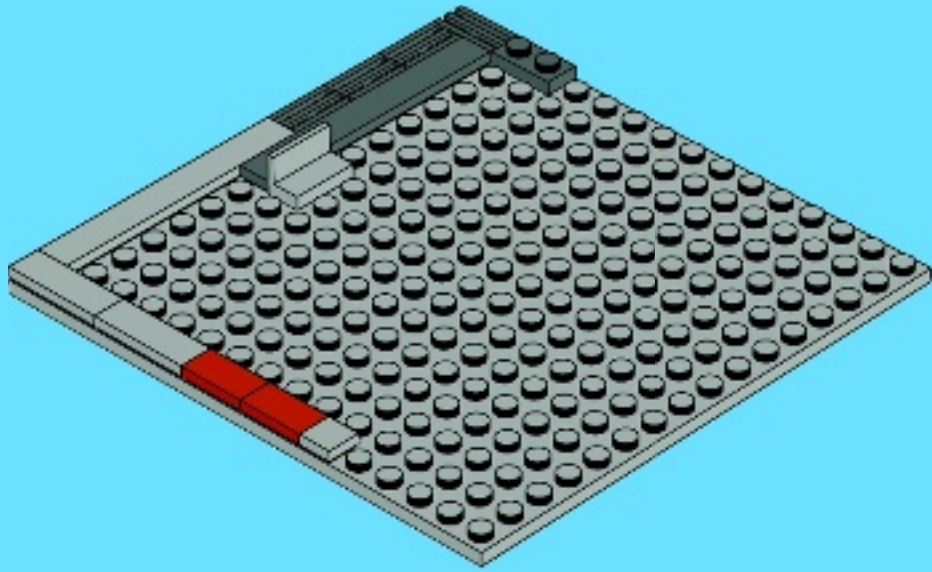

4

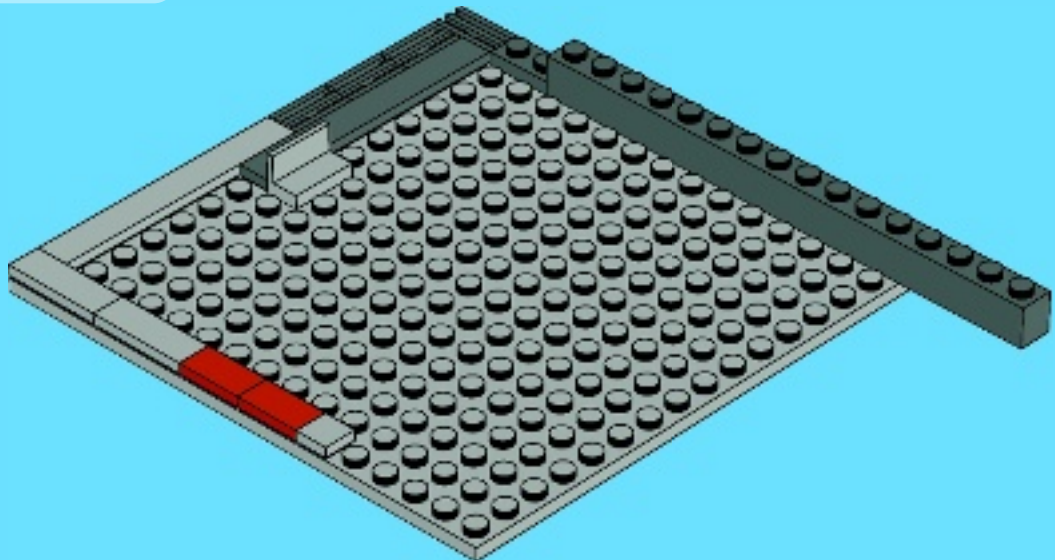

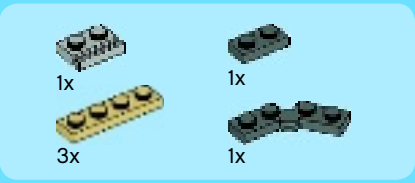

5

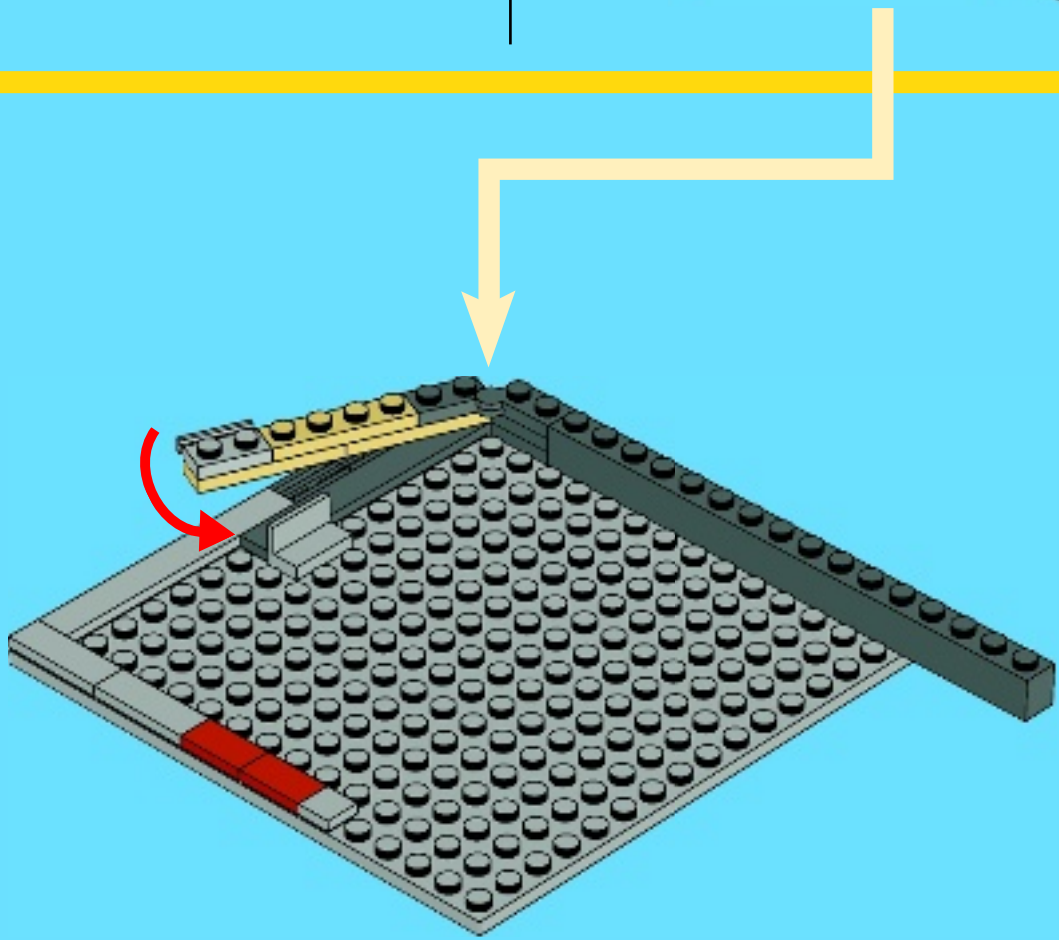
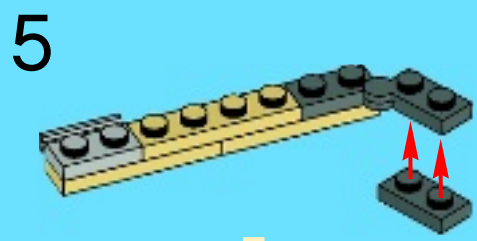
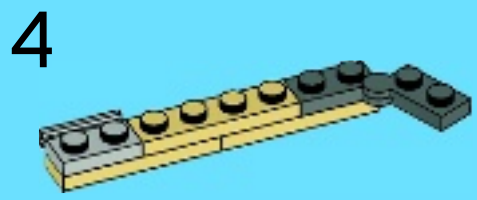
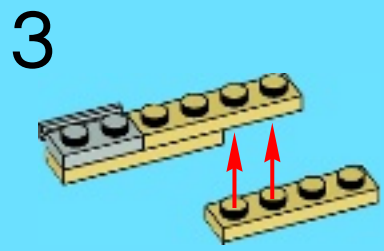
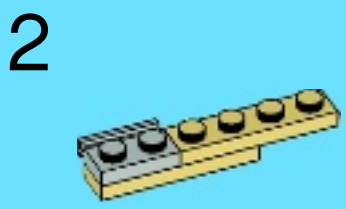
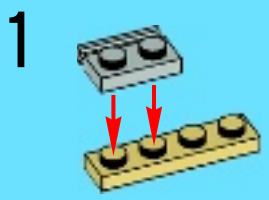



1x



1x



1x



1x



1x

6

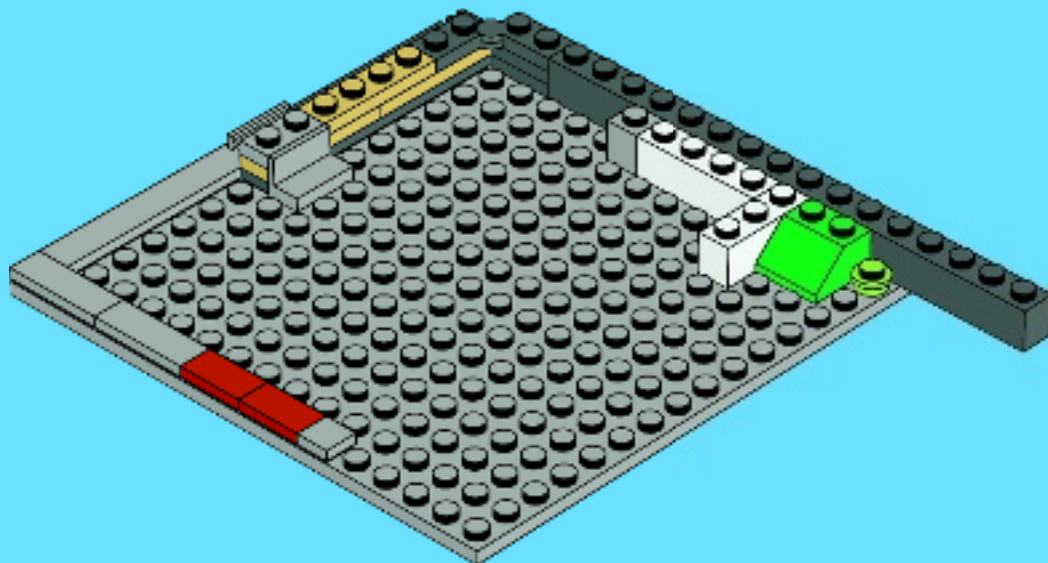

1x



2x









2x

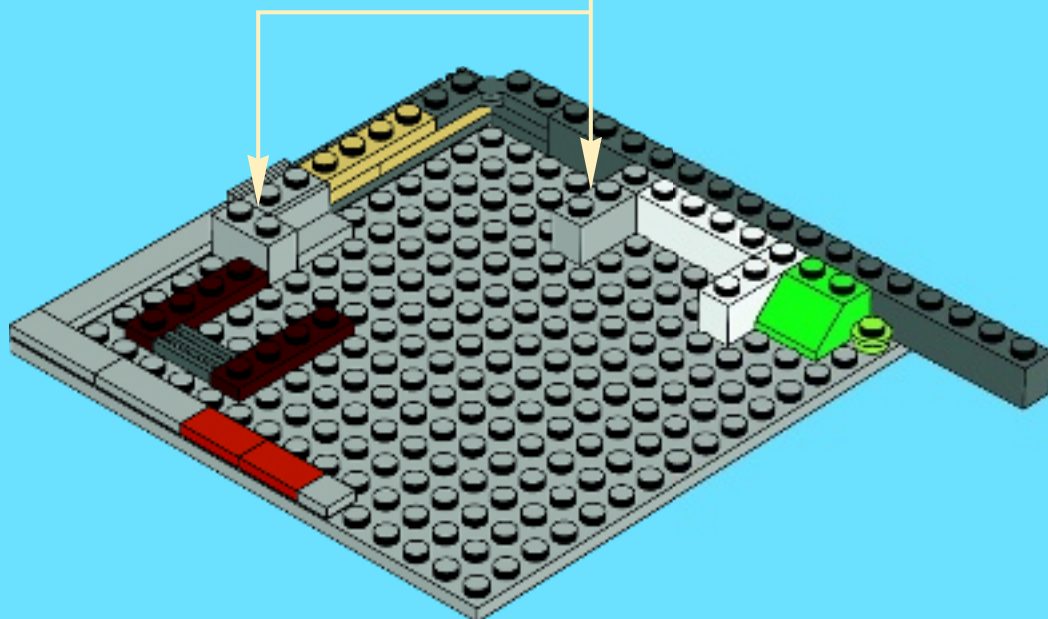

2x

7



- 2x 
- 2x 
- 6x 
- 1x 
- 1x 

8

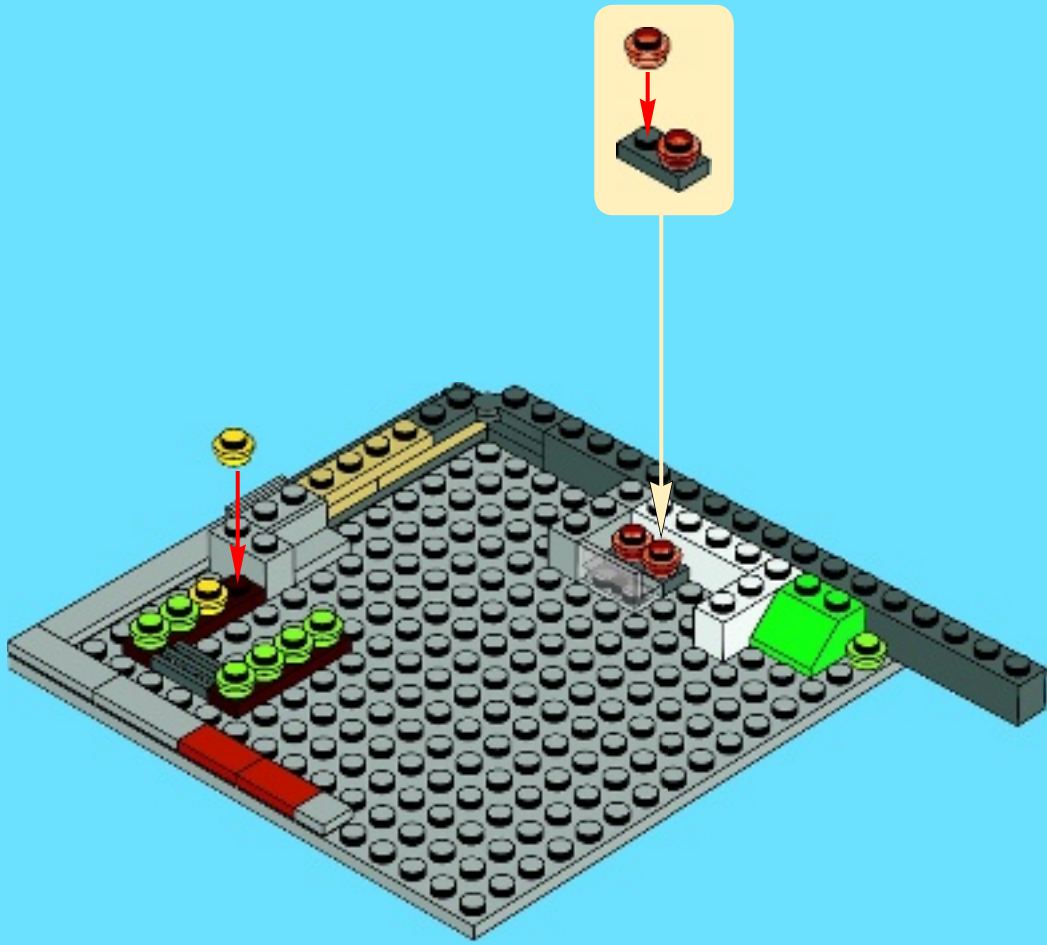



9

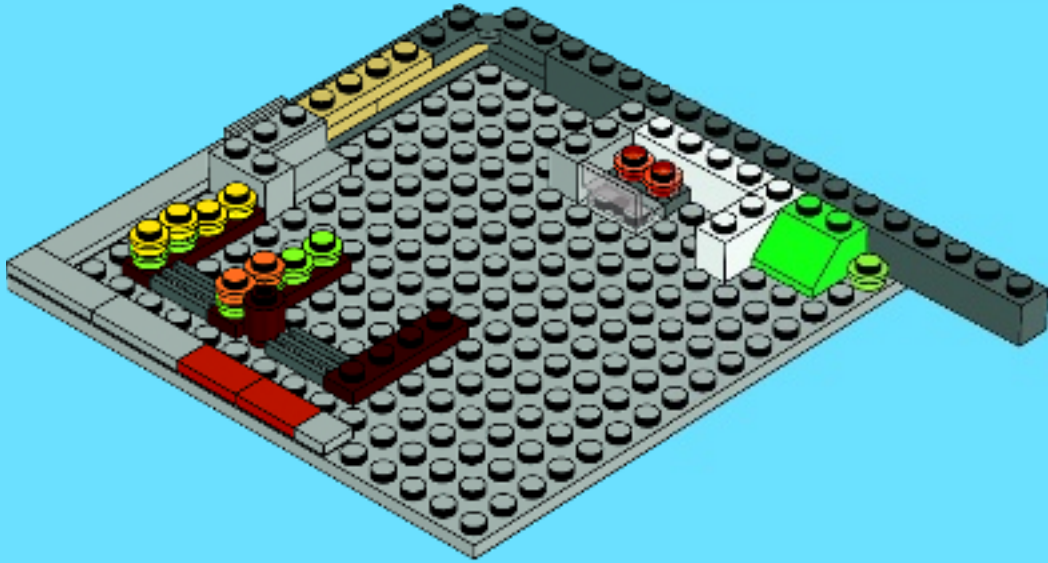

10

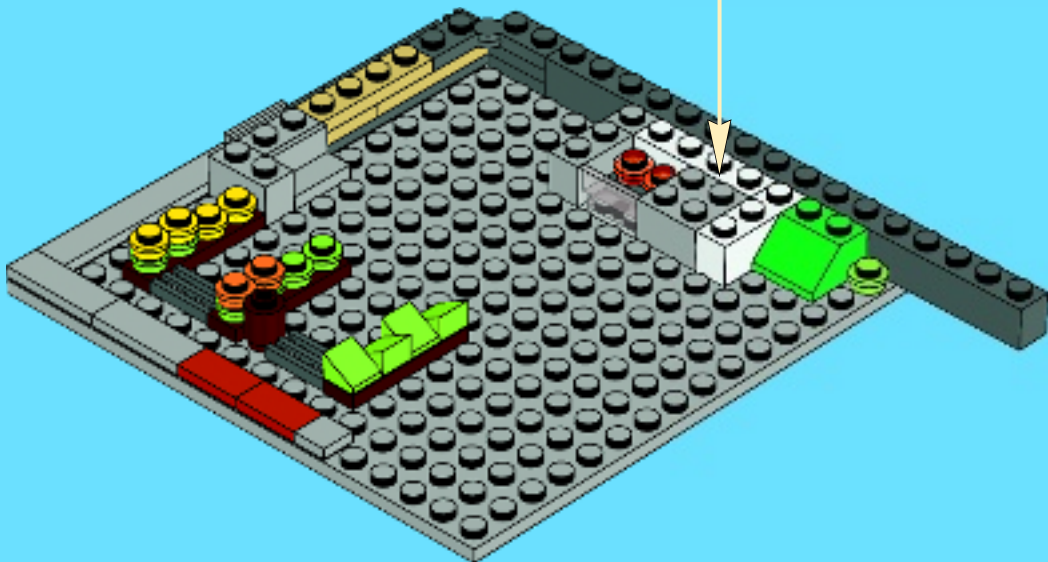
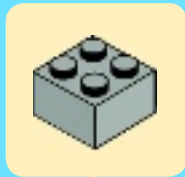

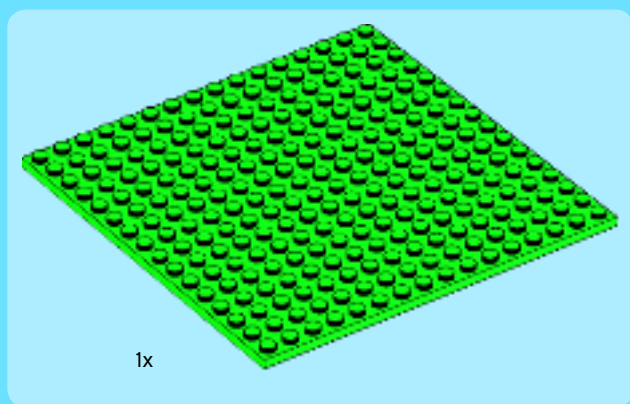

11

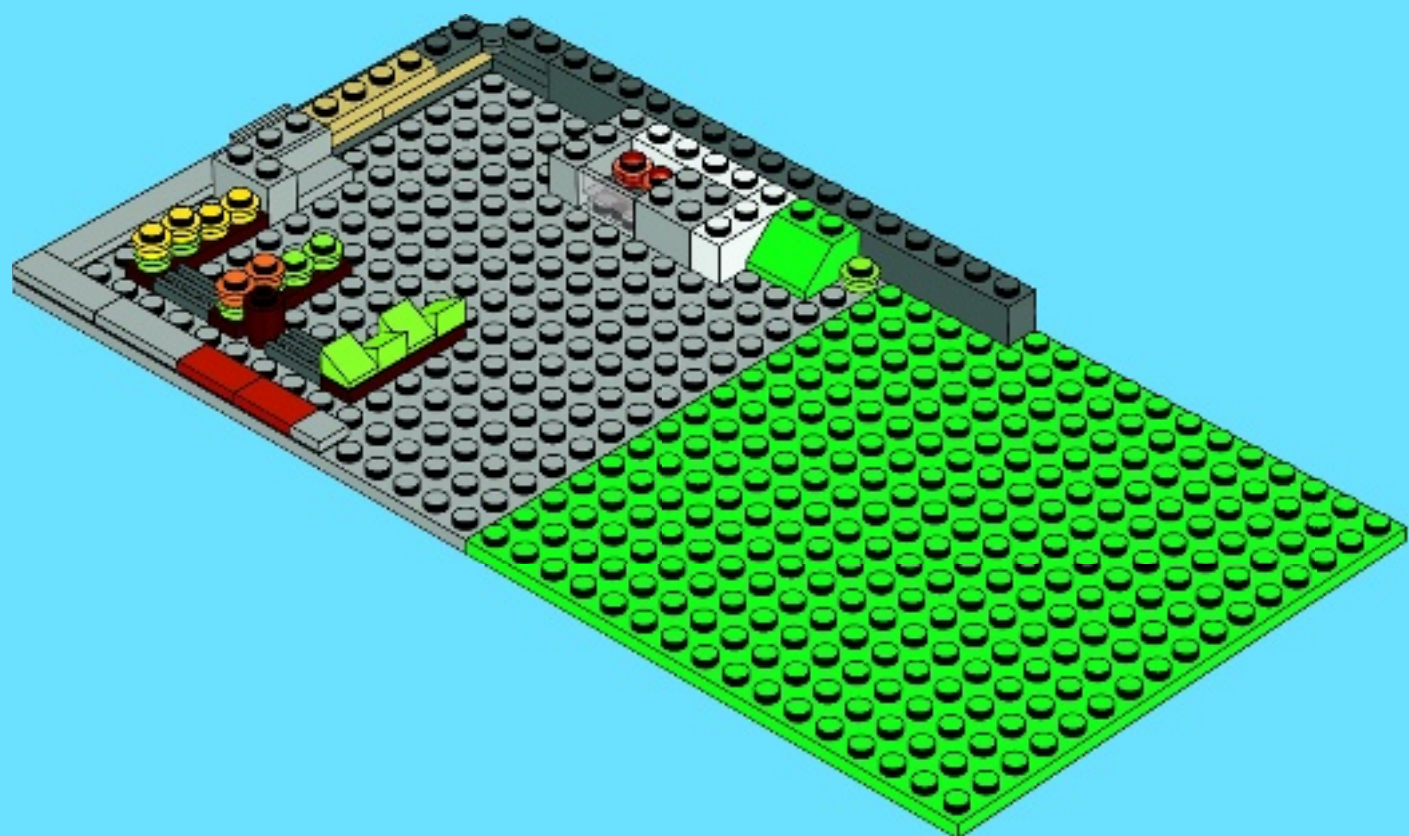

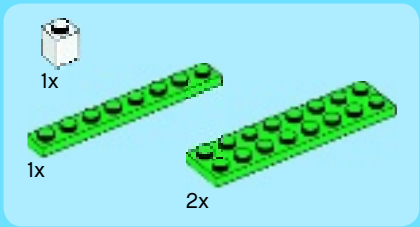

12

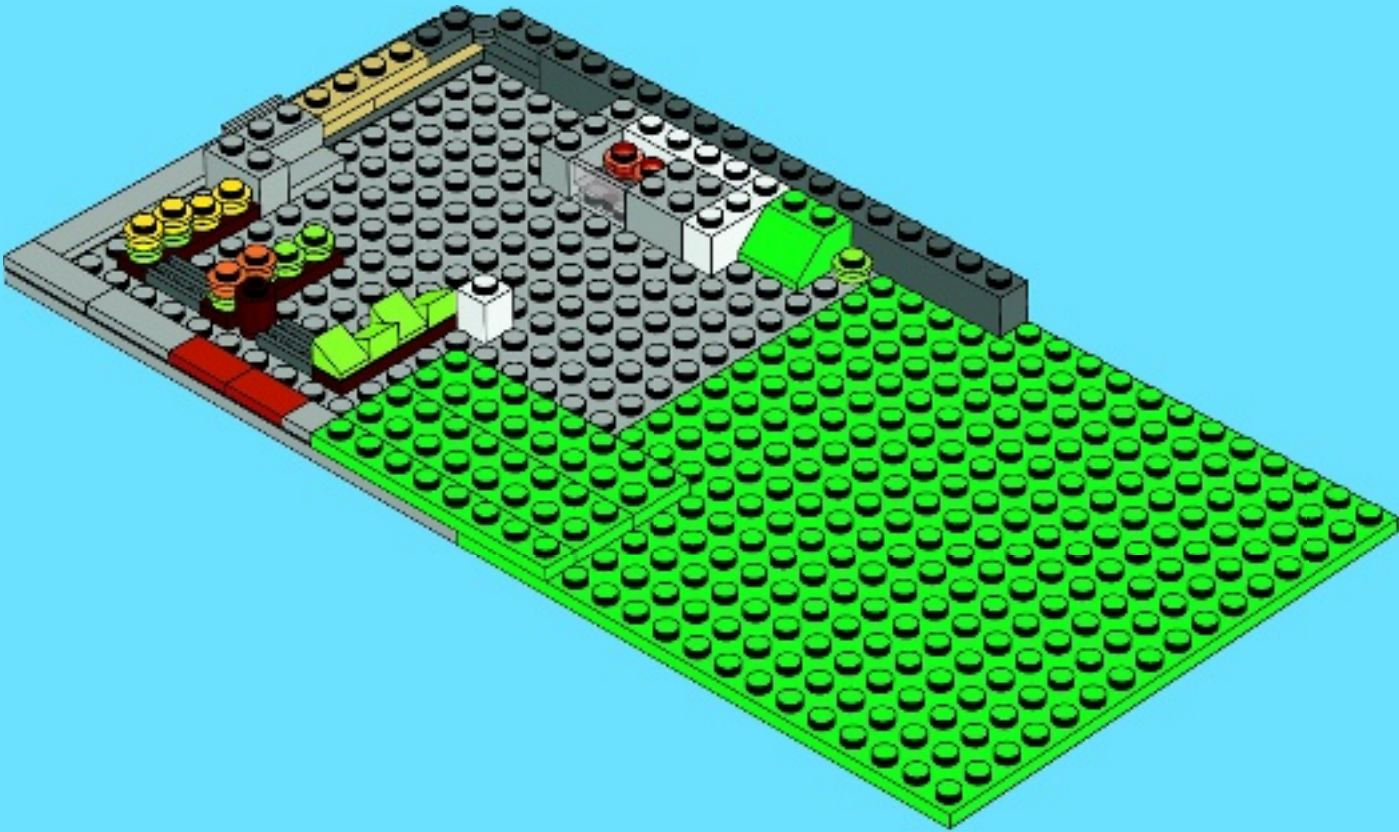



13

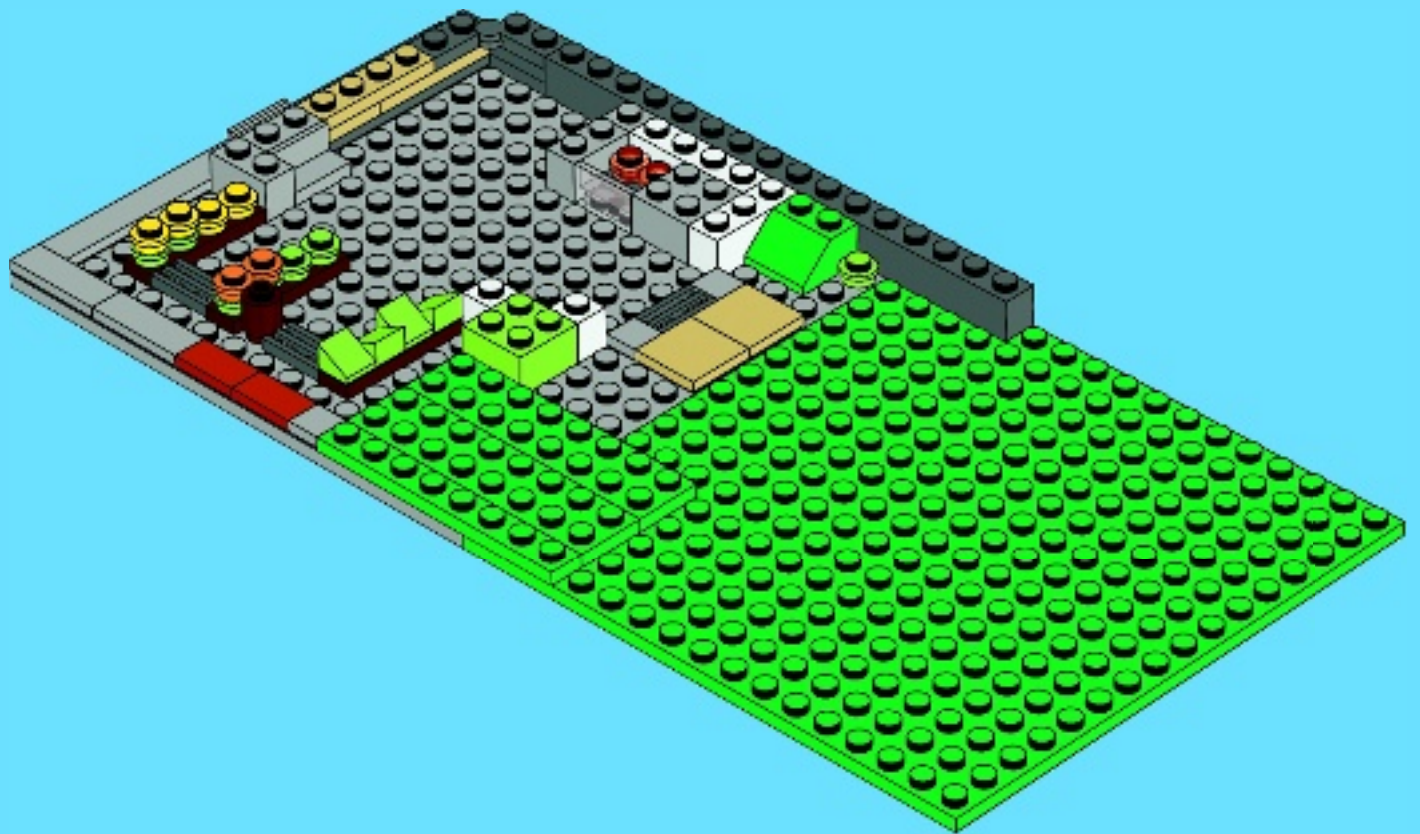

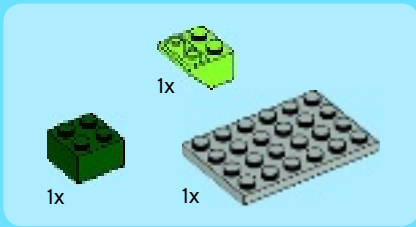

14

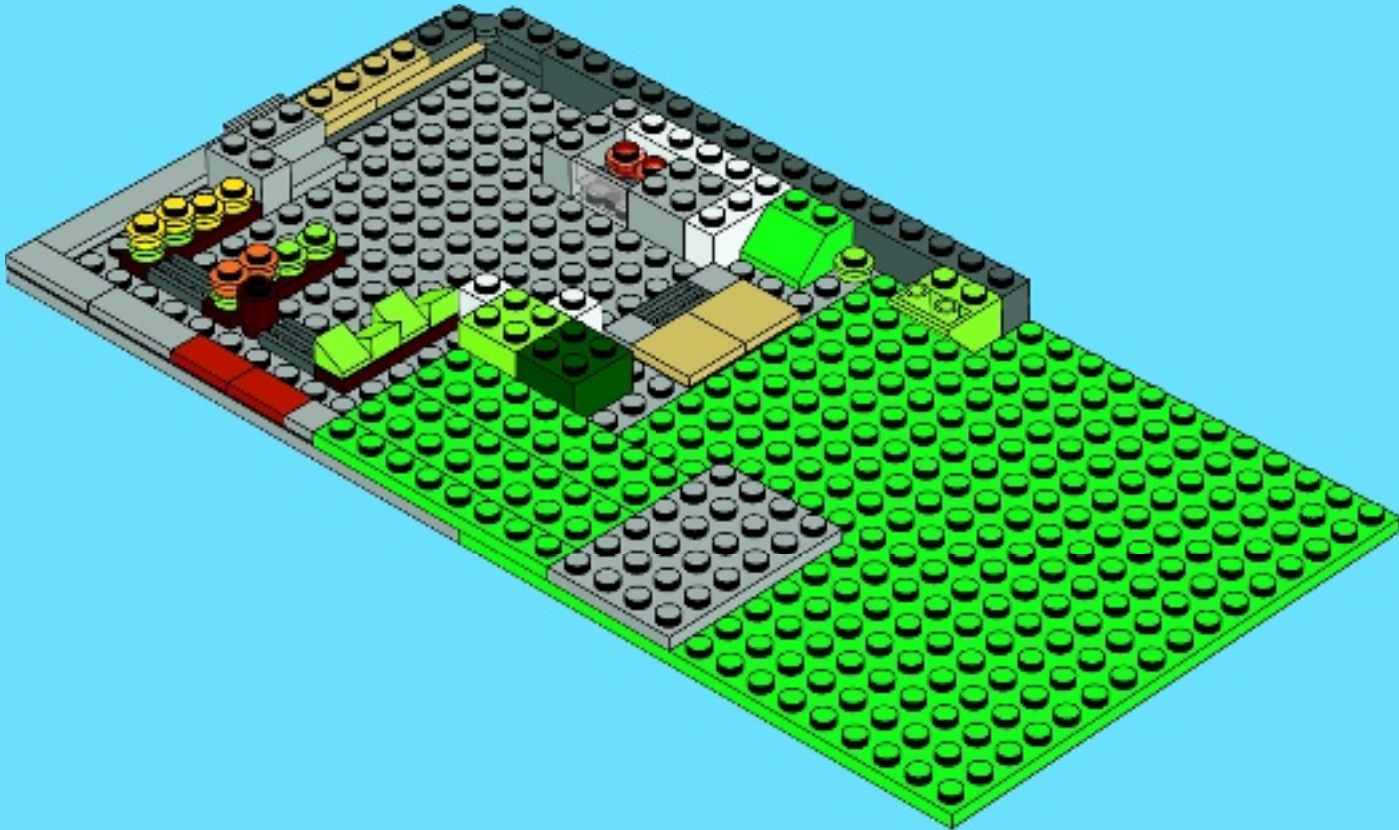

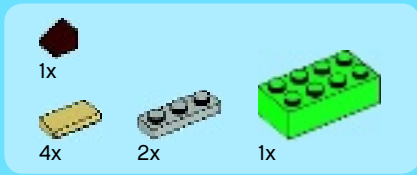

15

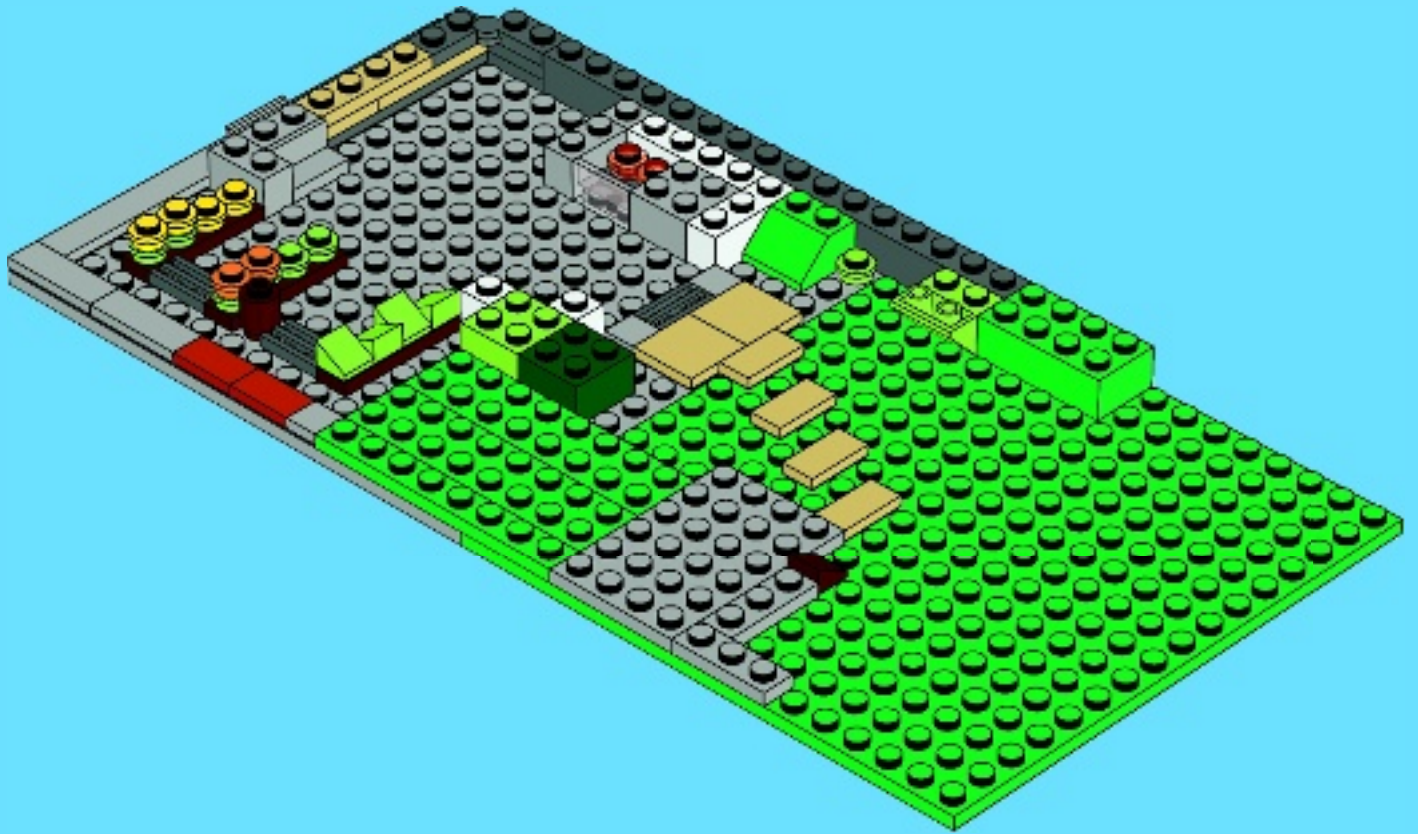



1x



1x

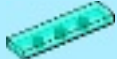

4x

16

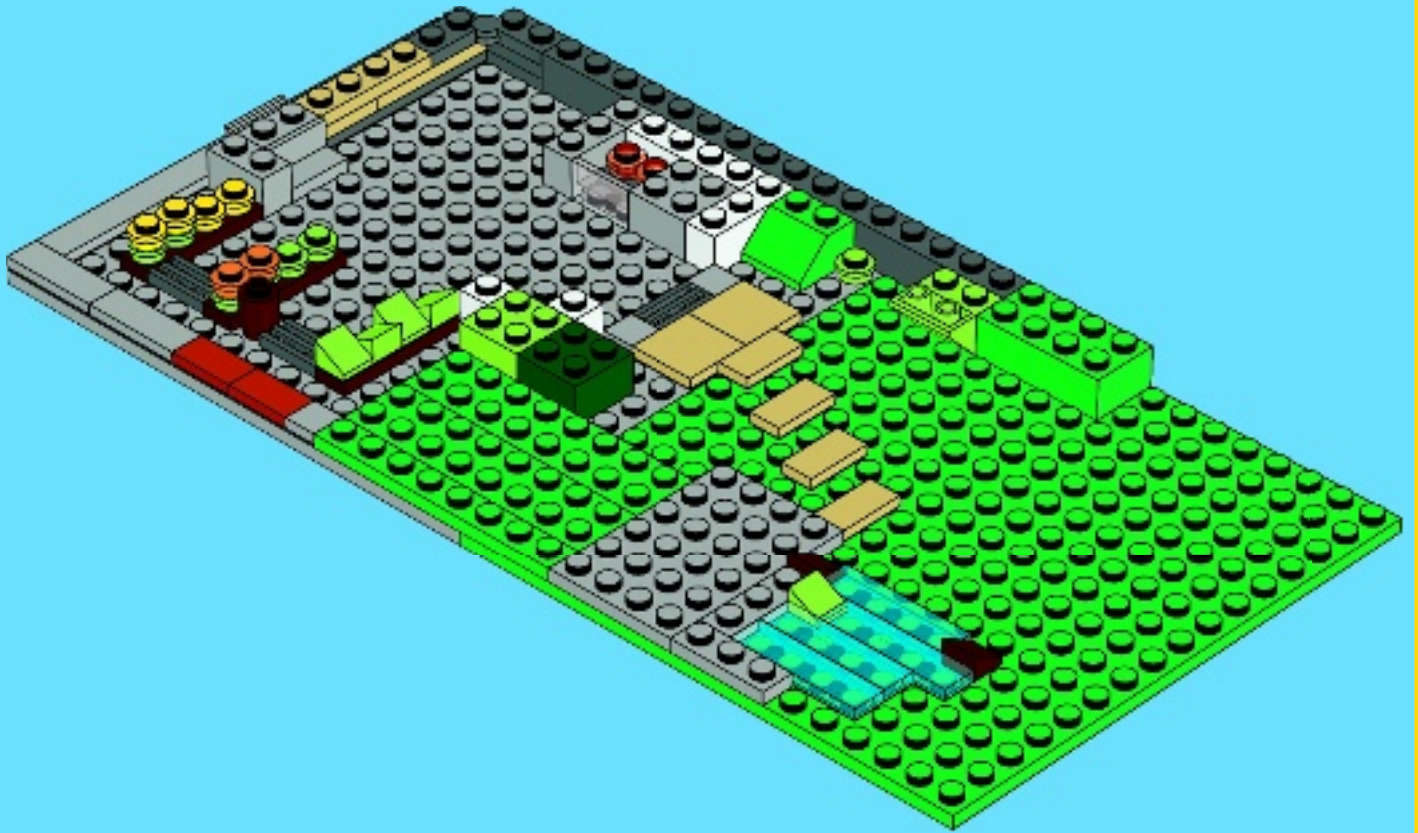

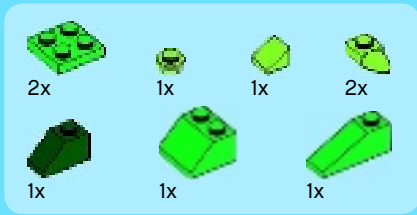

17

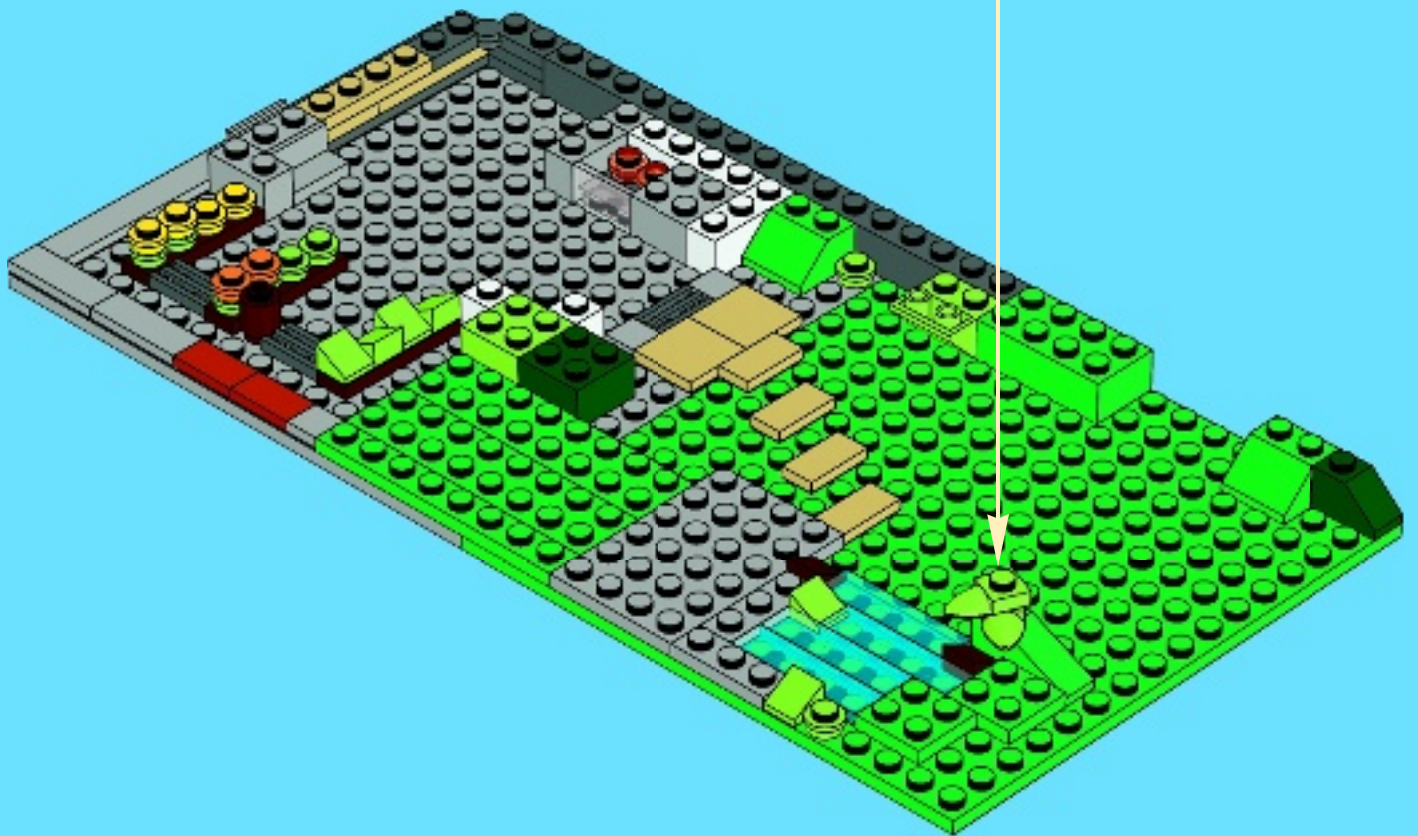
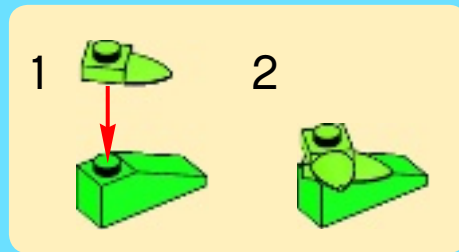



1x



1x



3x

18

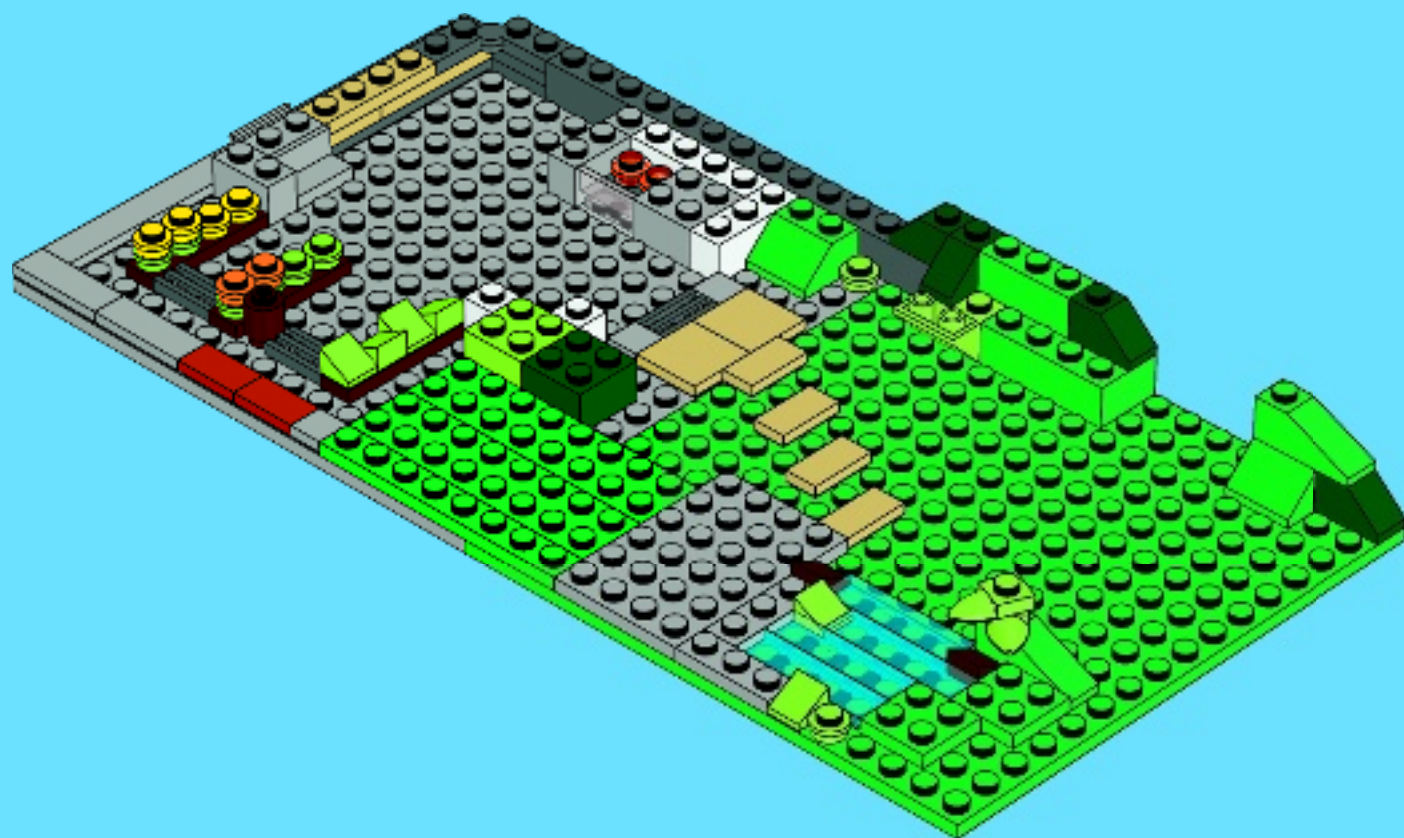



1x



2x

19

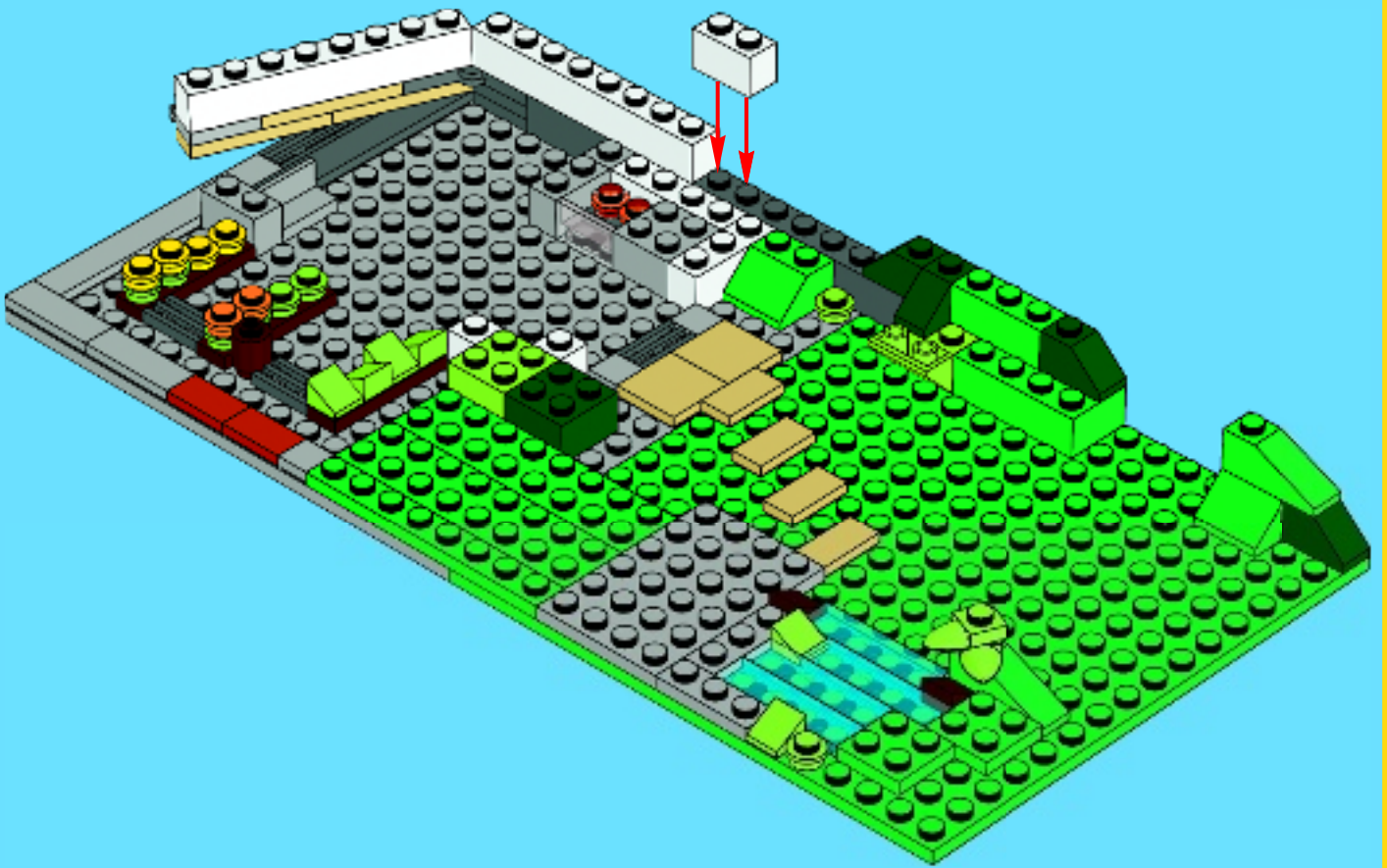



20

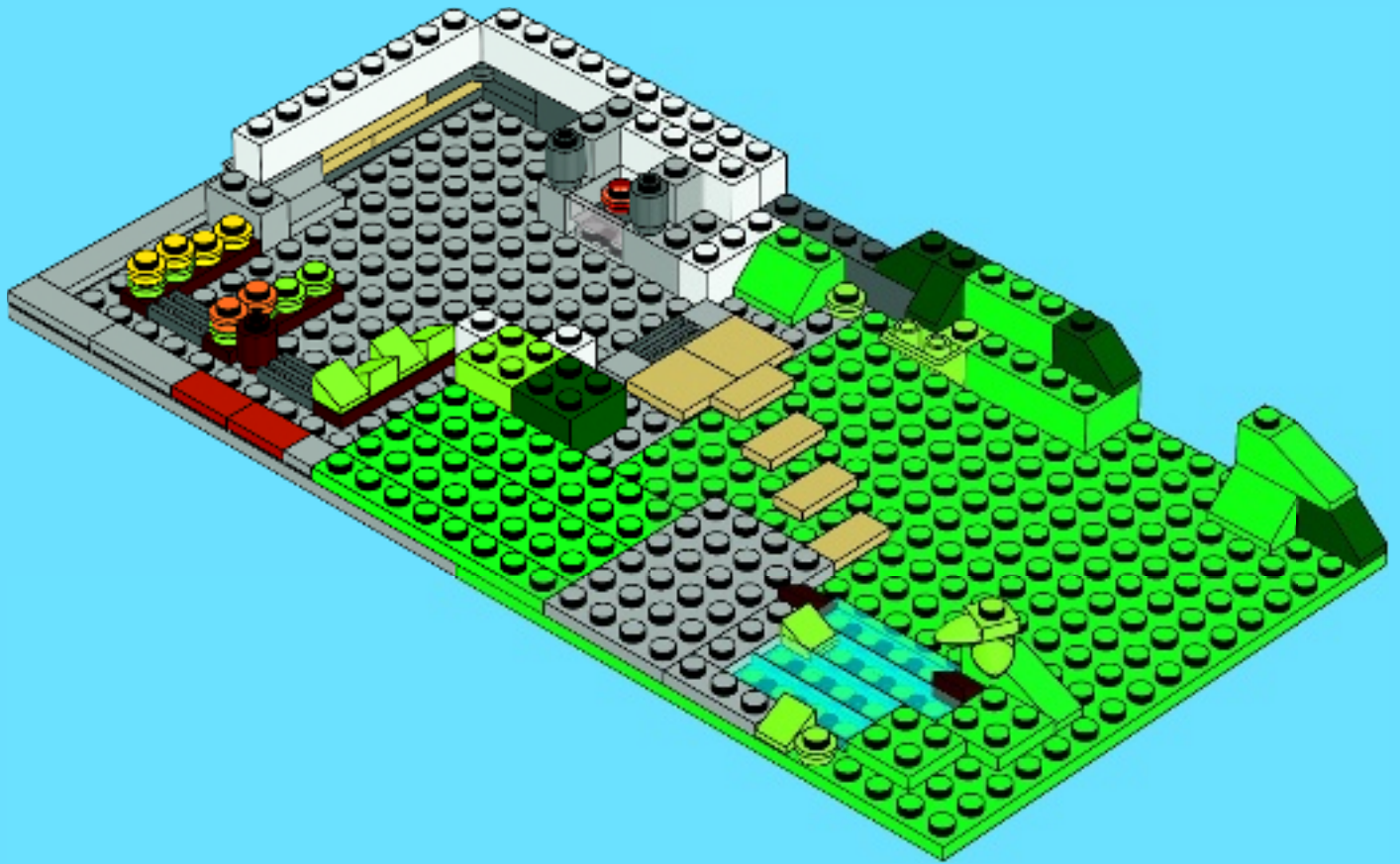



2x



2x



2x

21

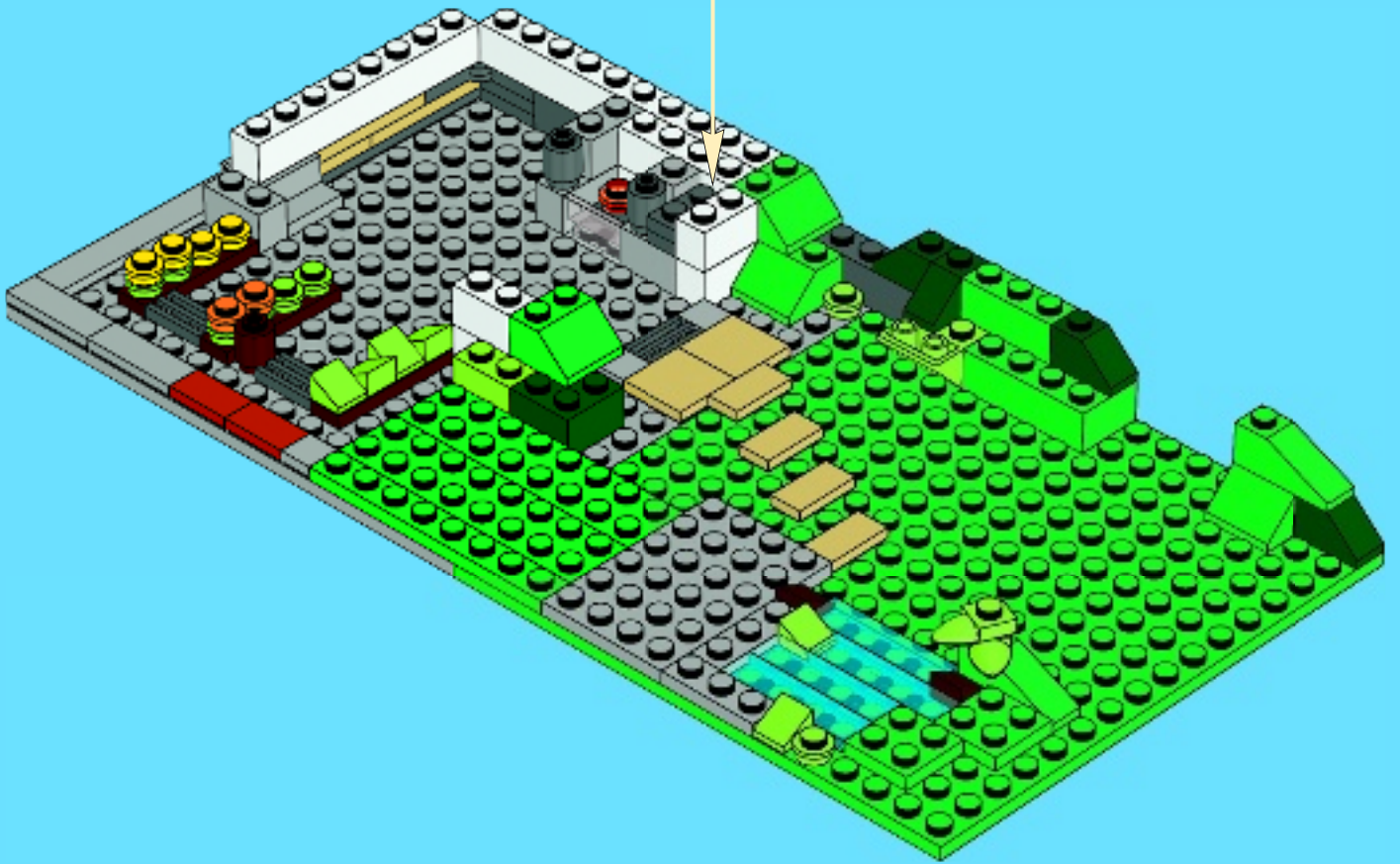
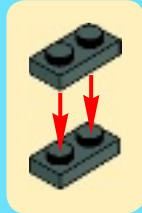



3x



2x



1x

22

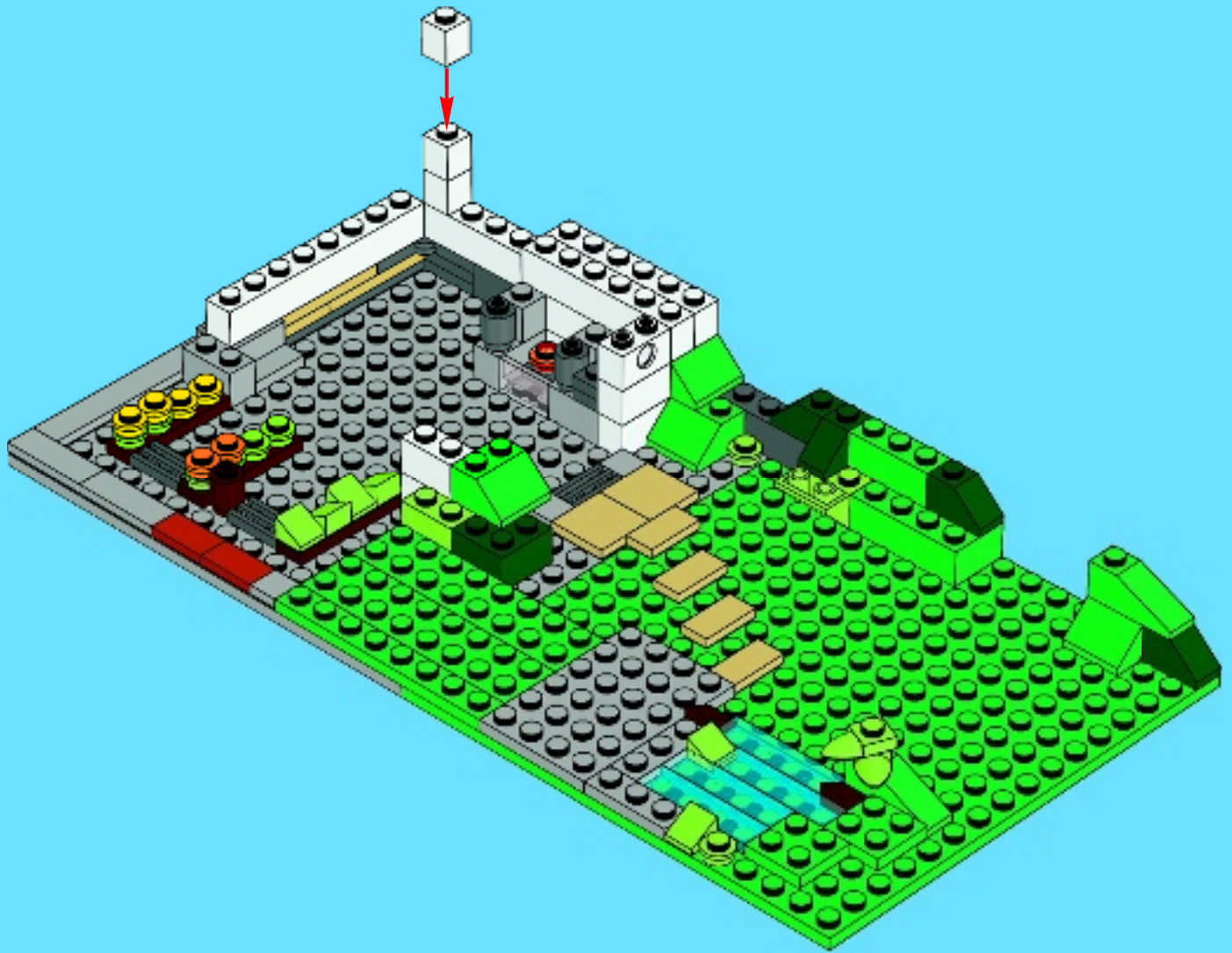

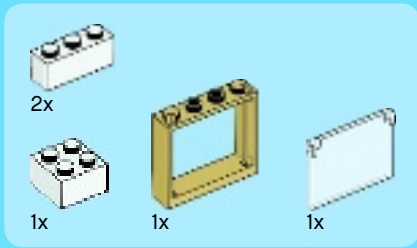

23

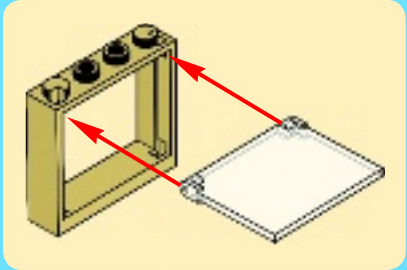

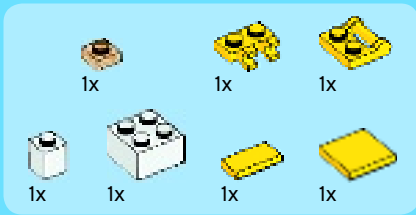

24

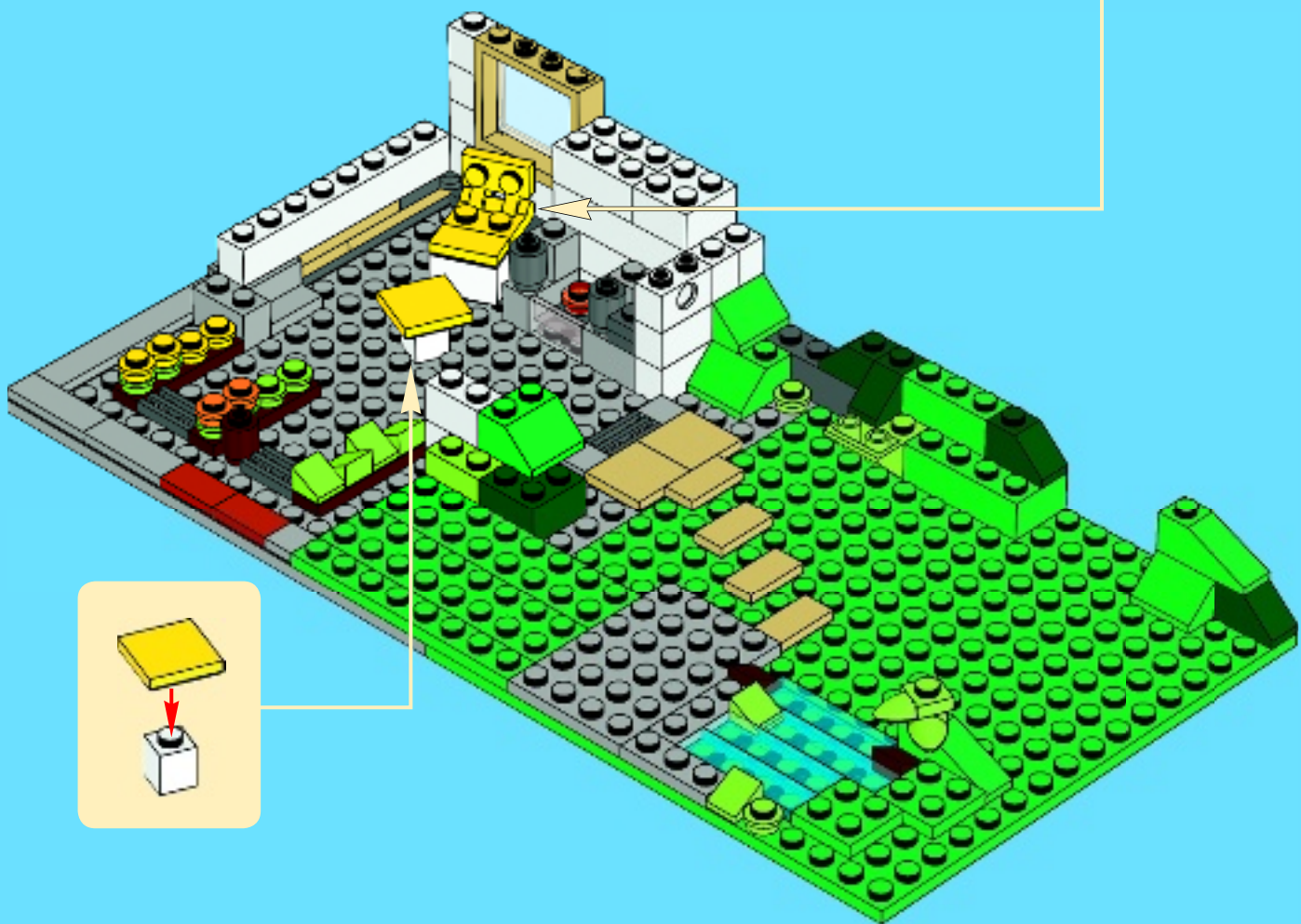
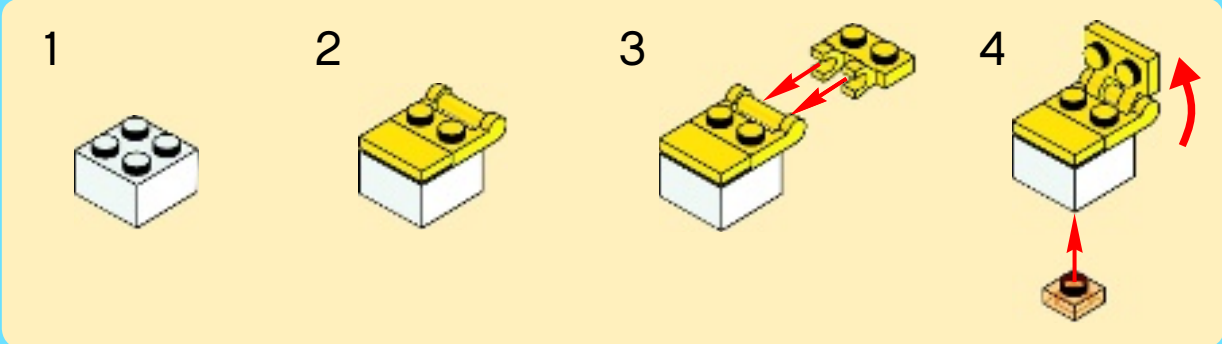



25

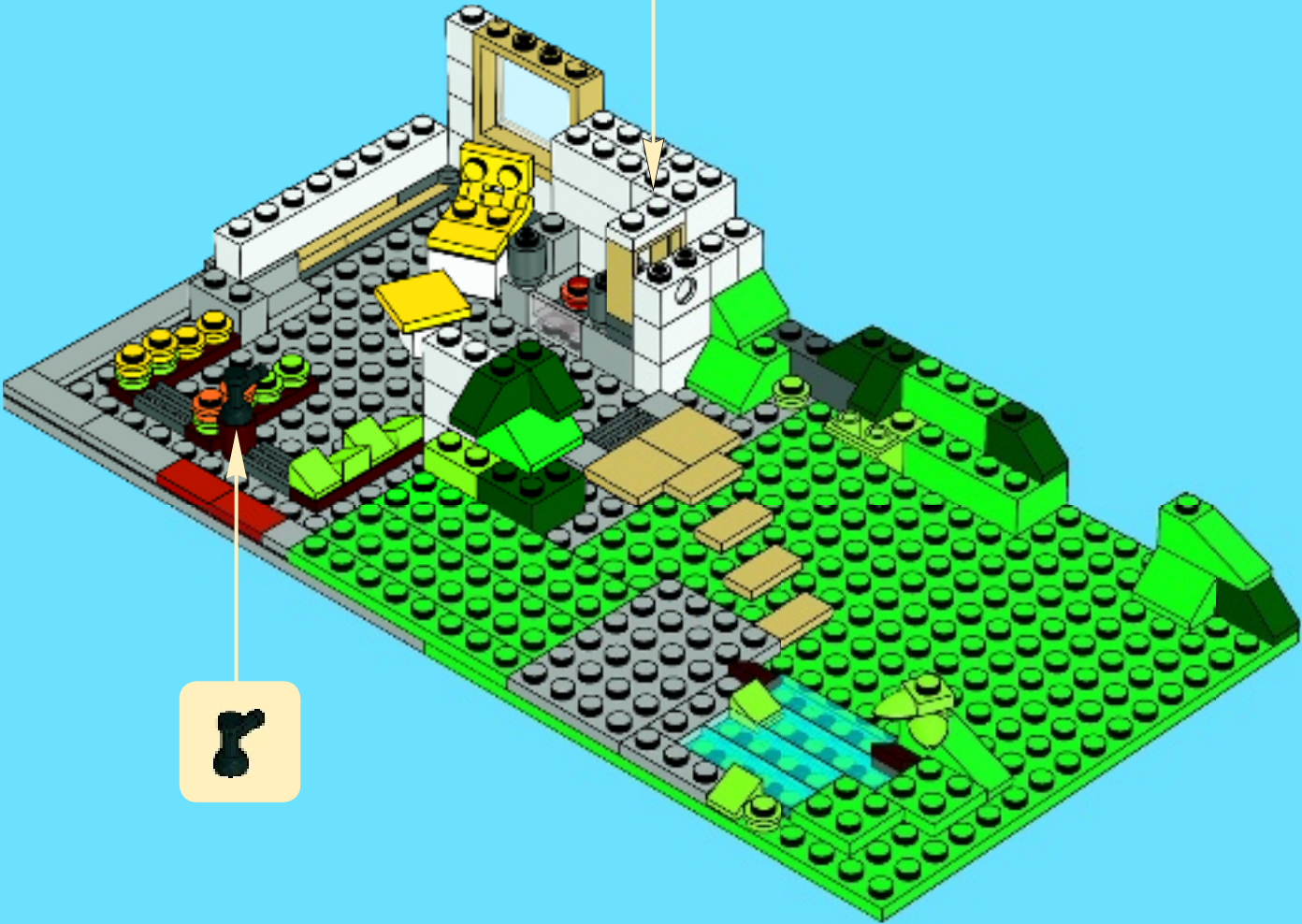
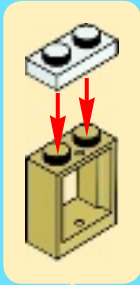



1x



26

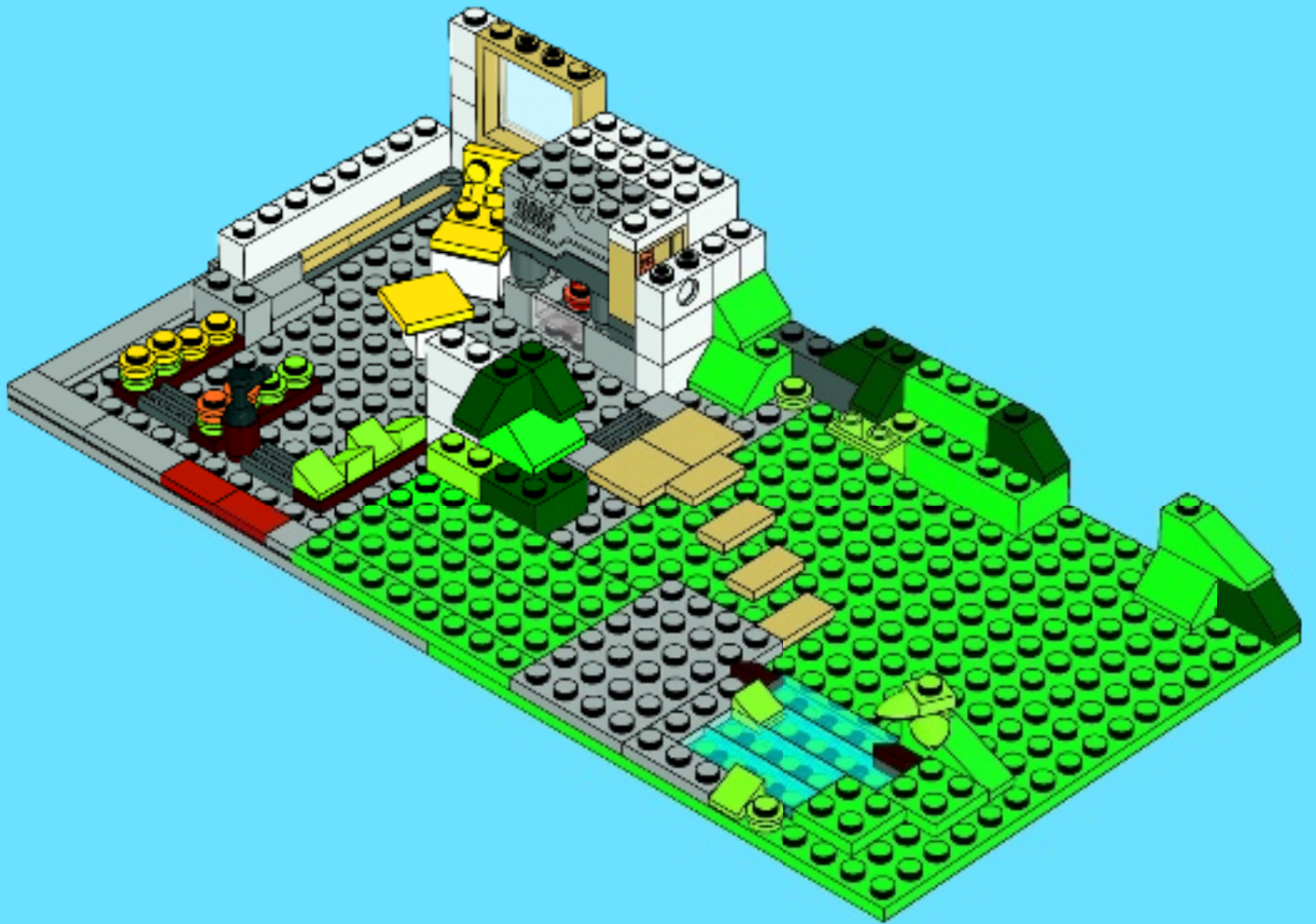



1x



1x

27

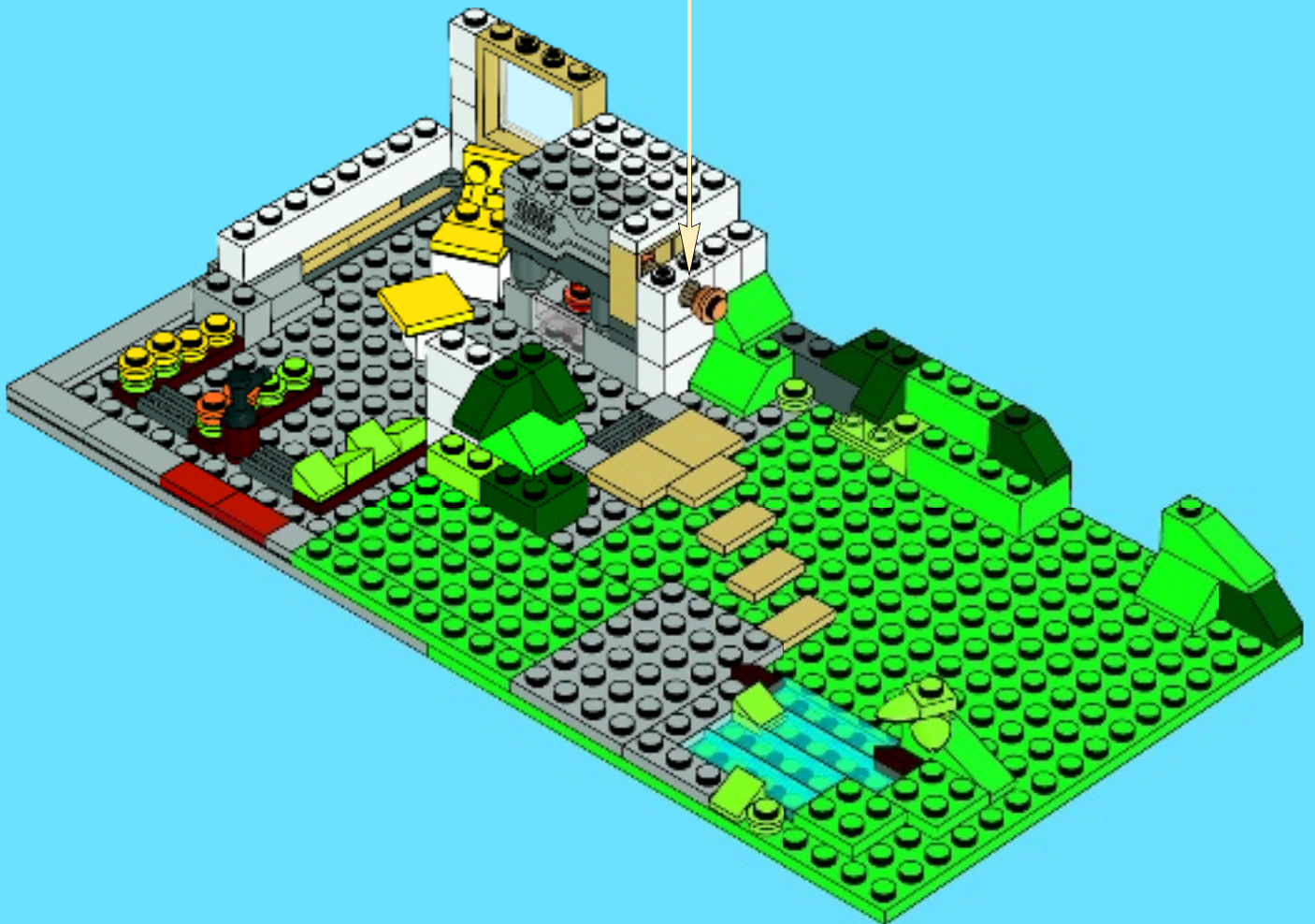
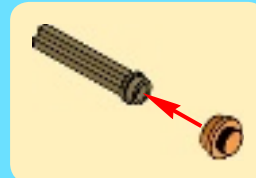

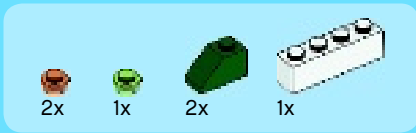

28

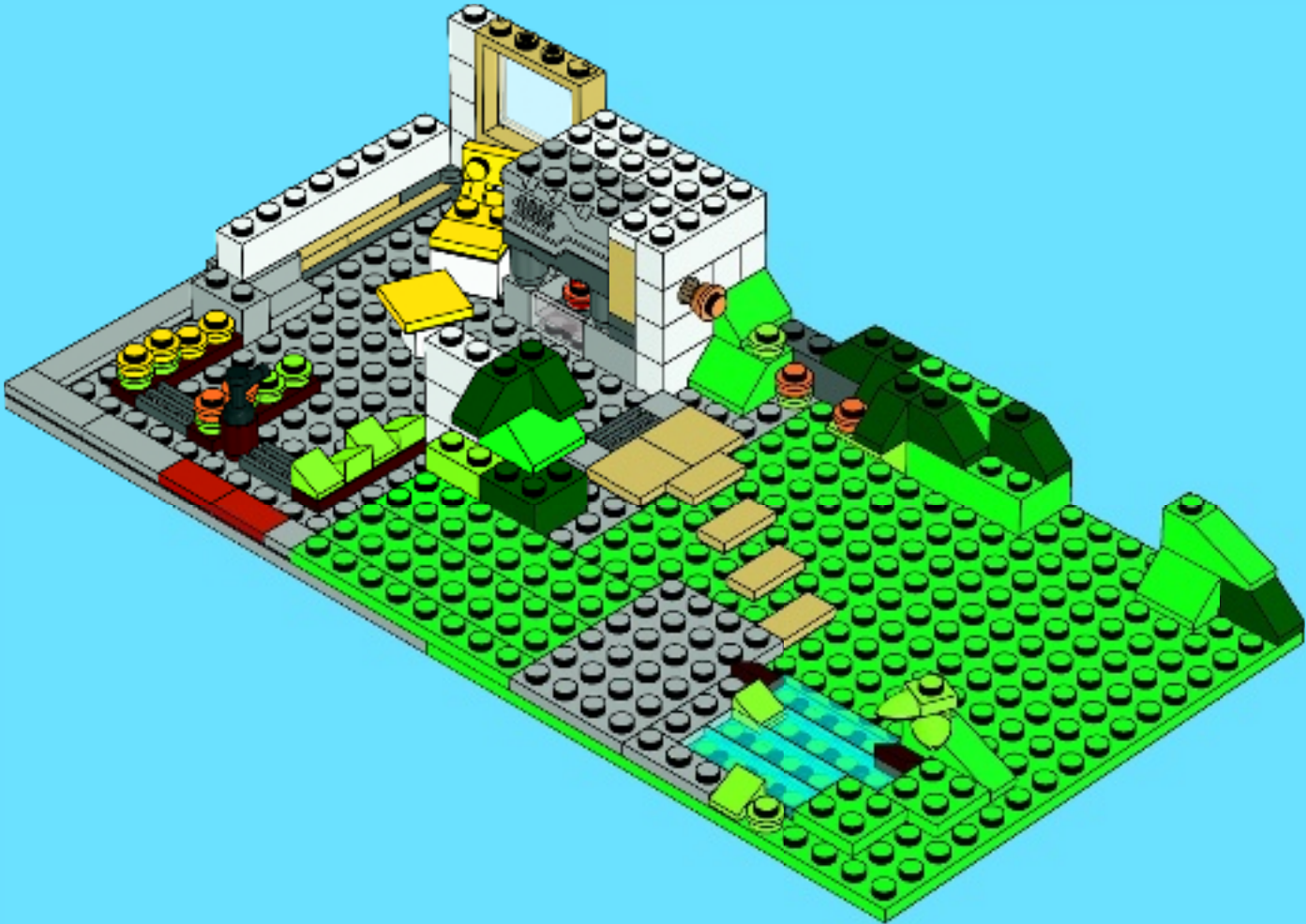

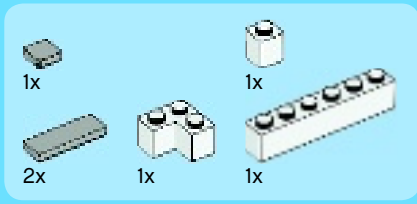

29

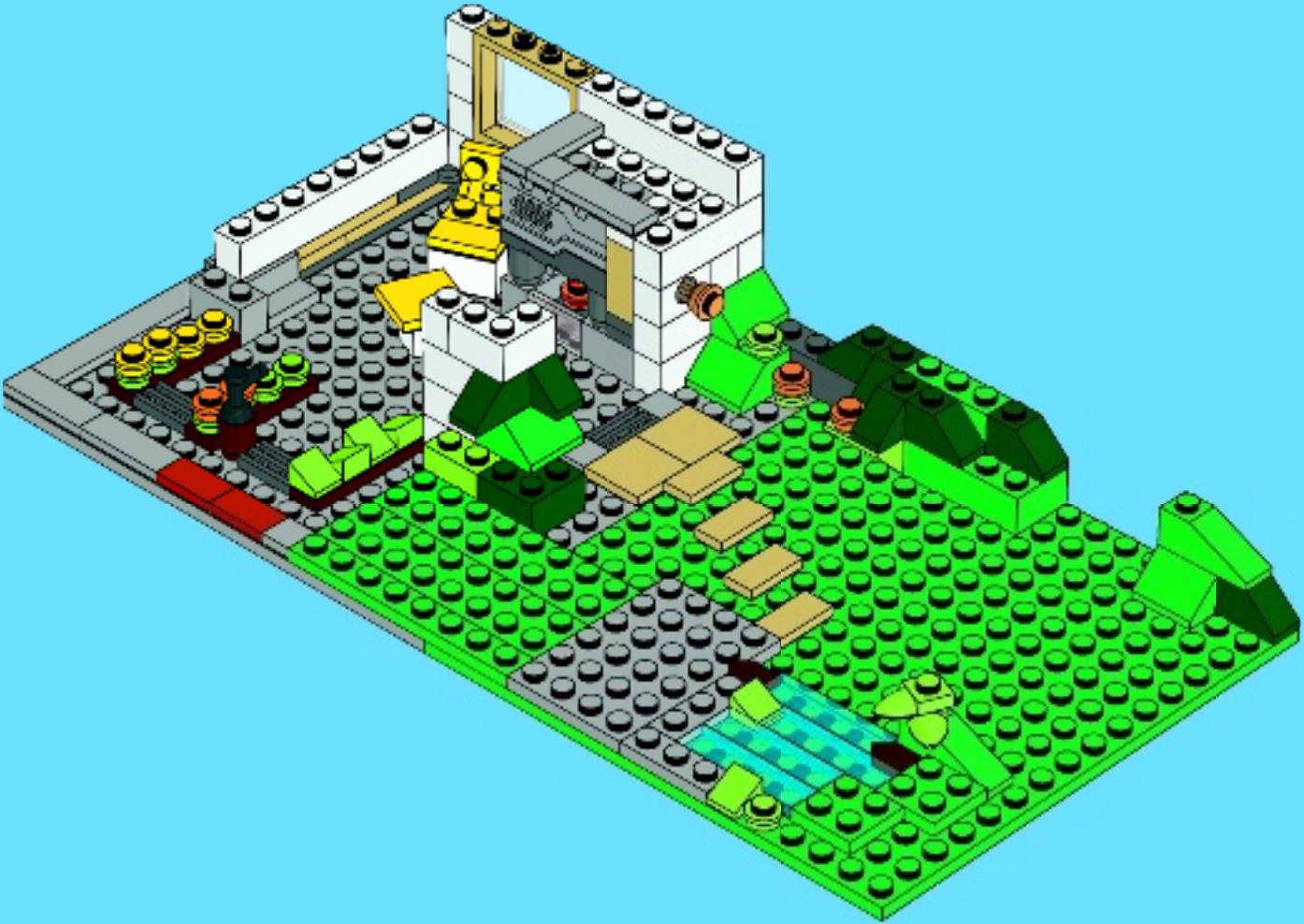



2x



1x

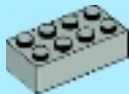

2x

30

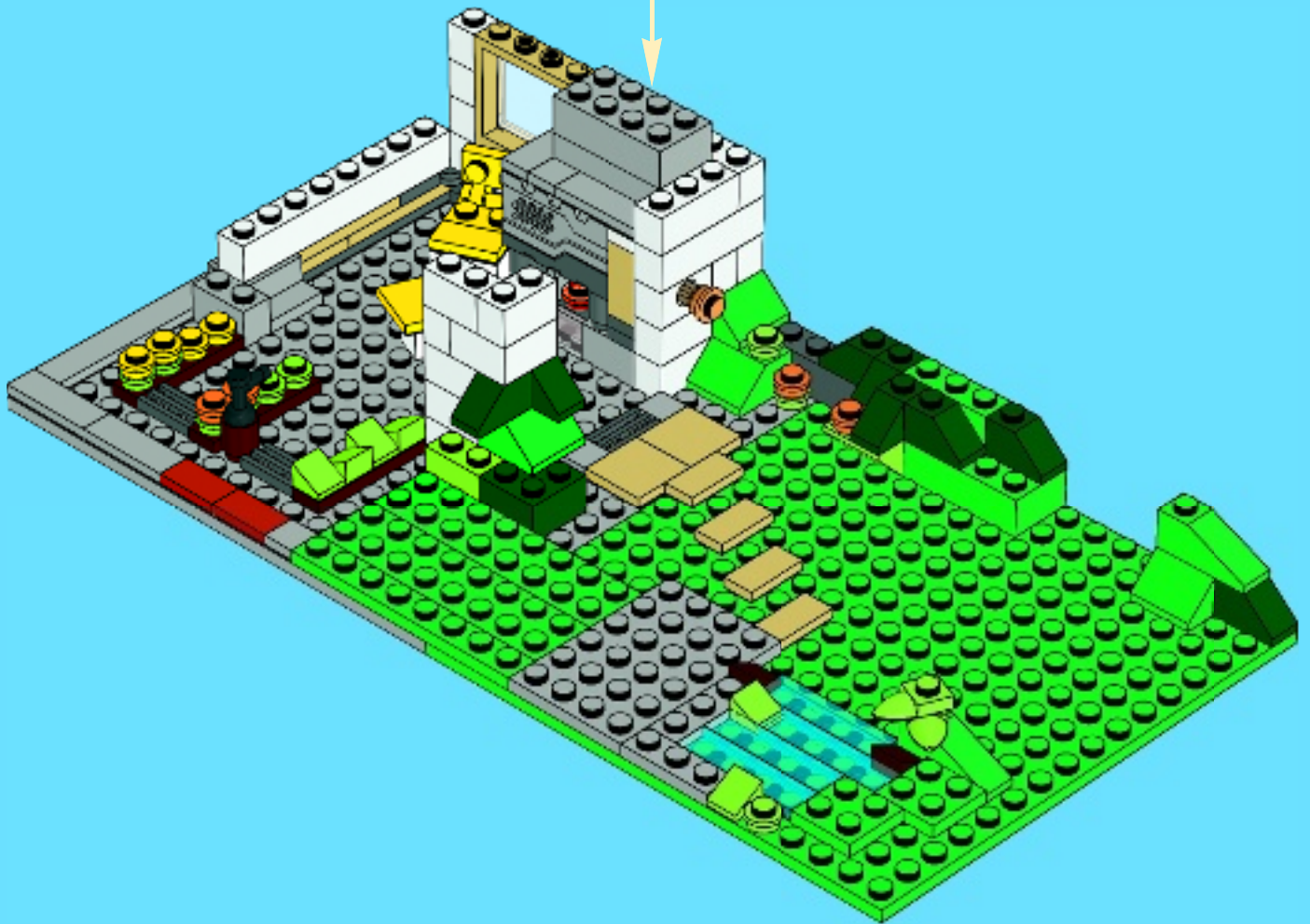
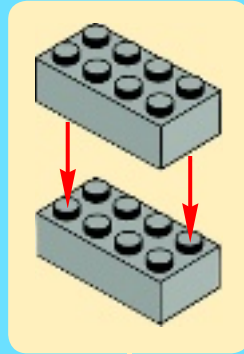

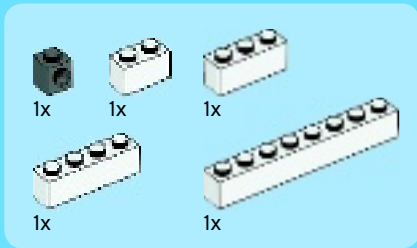

31

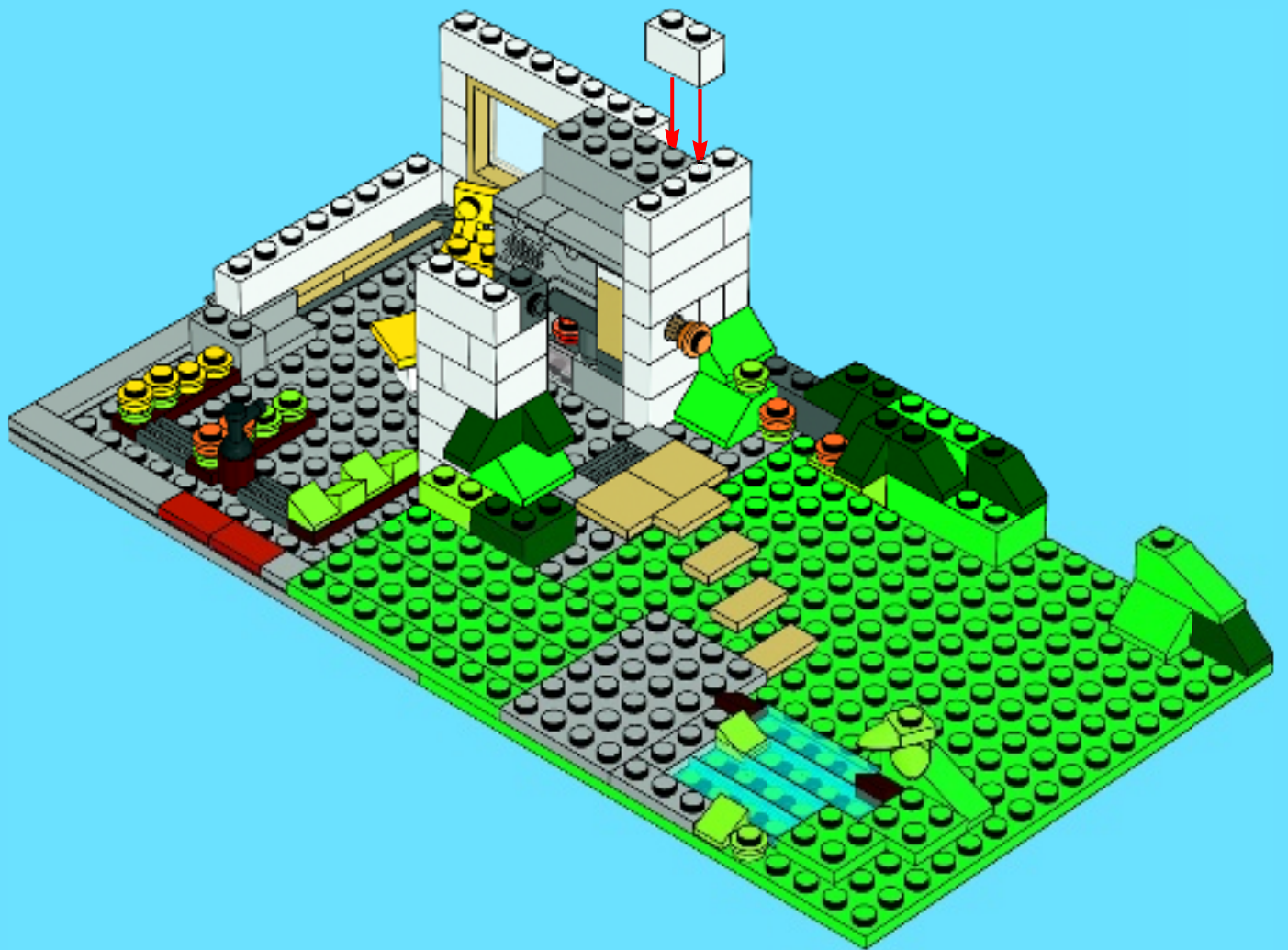

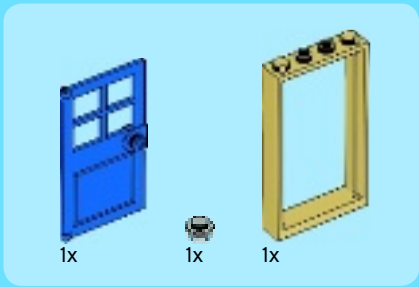

32

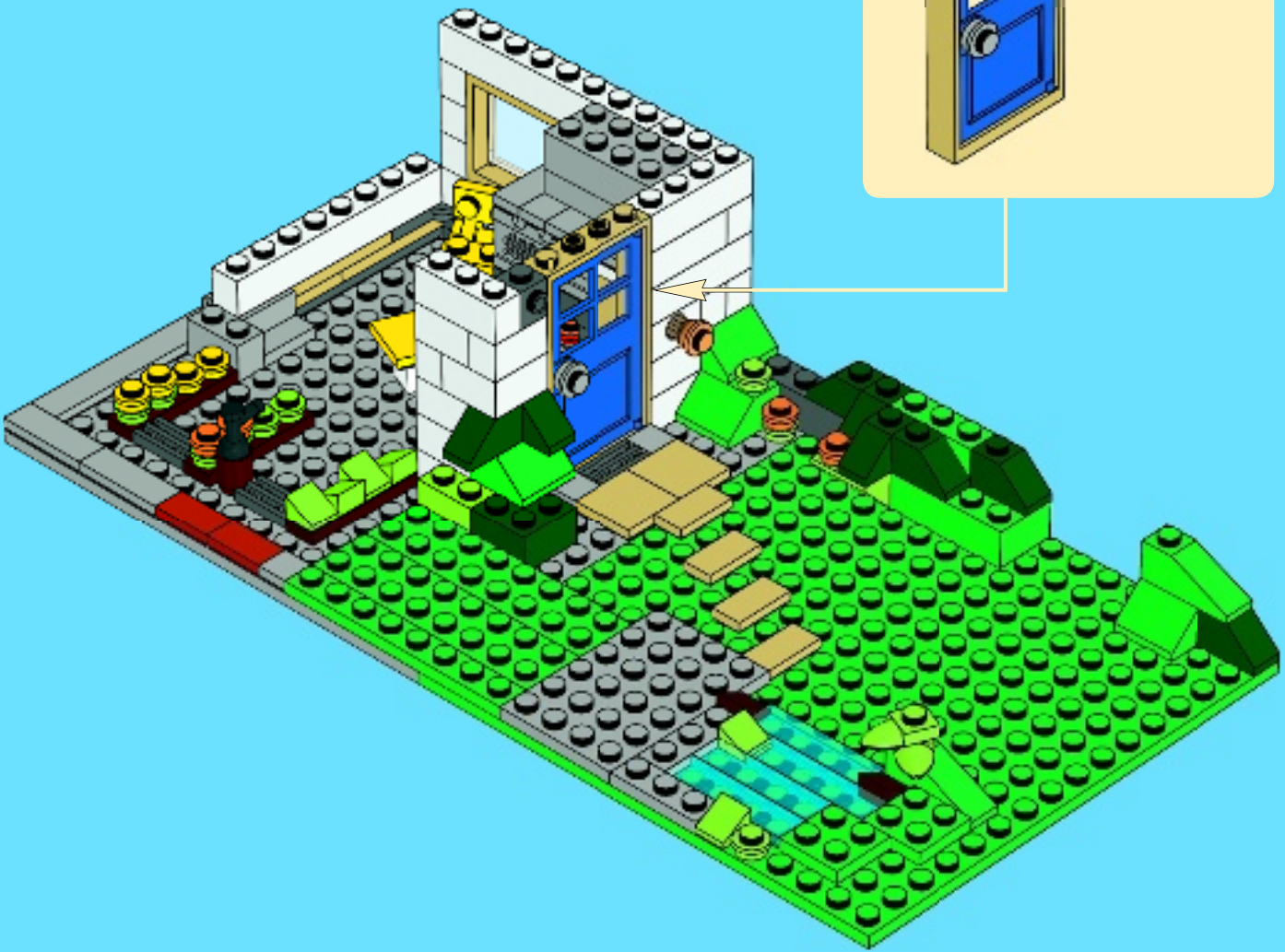
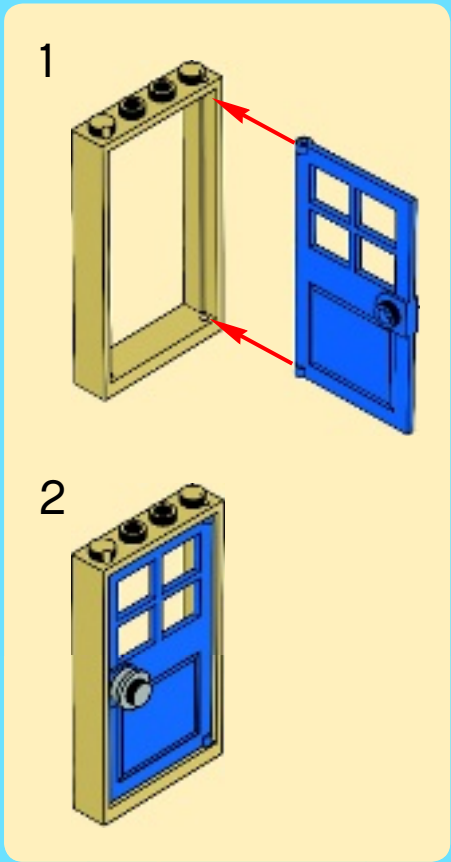

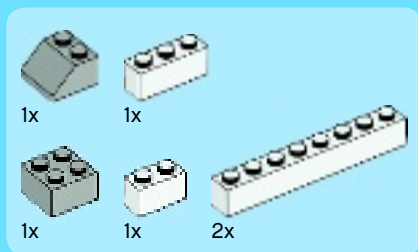

33





5x

34

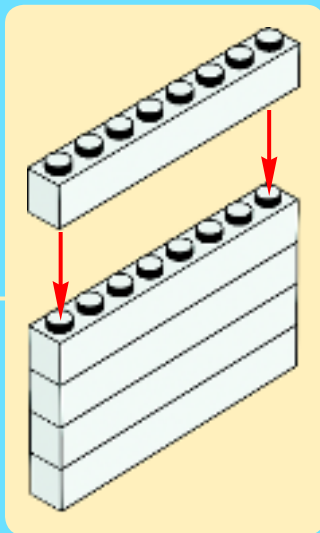

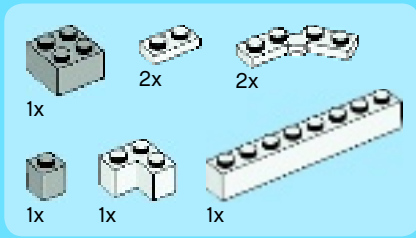

35

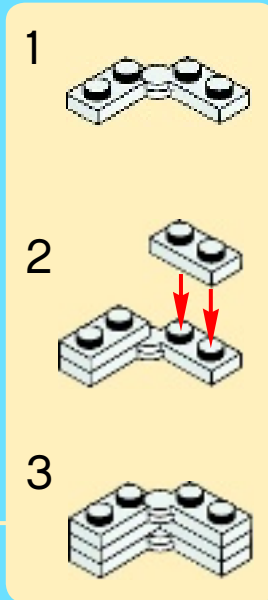



1x



1x

36





1x



1x



5x

37

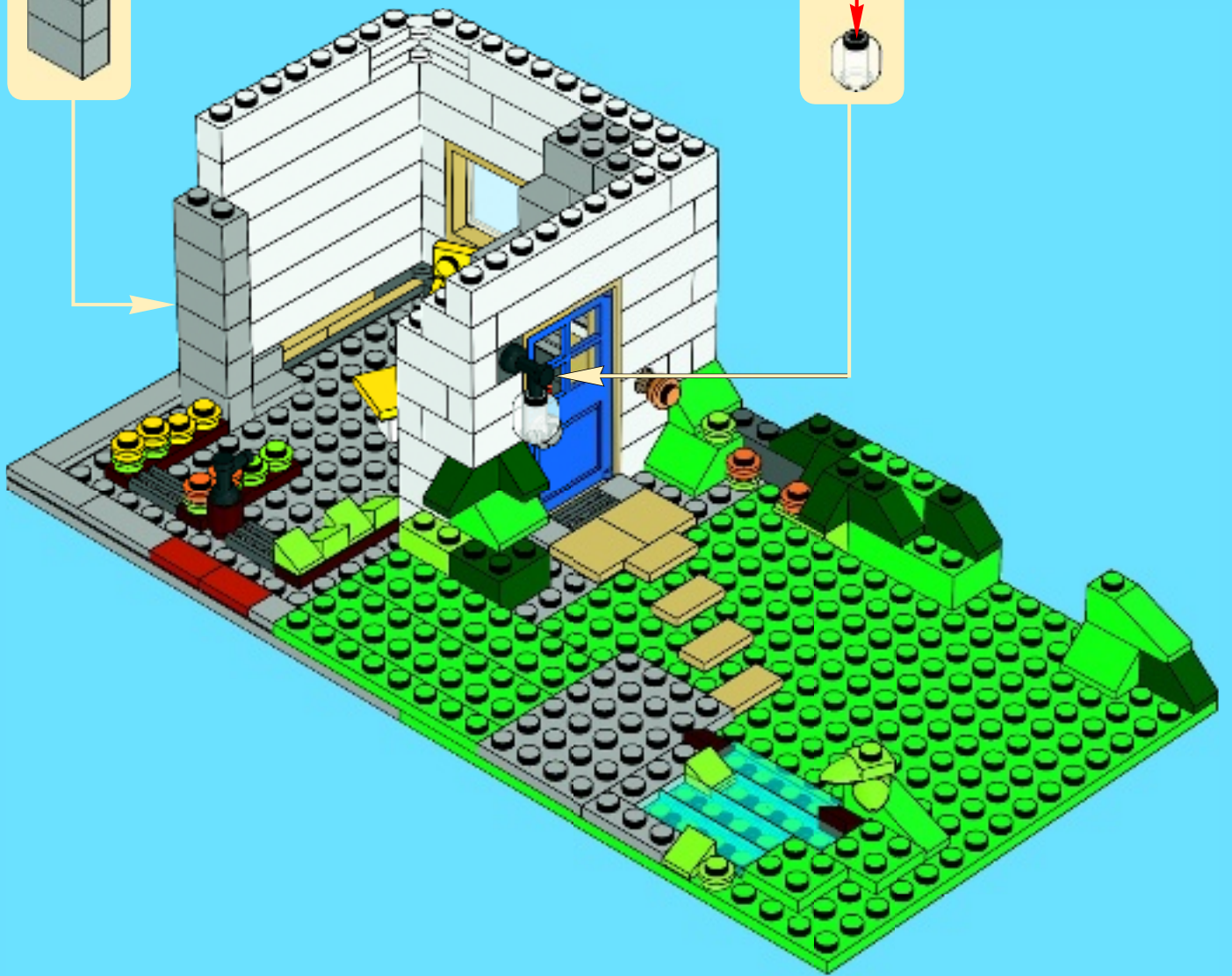
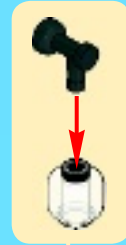
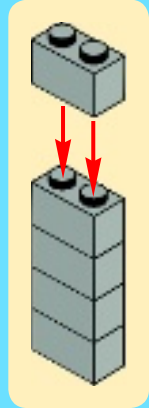

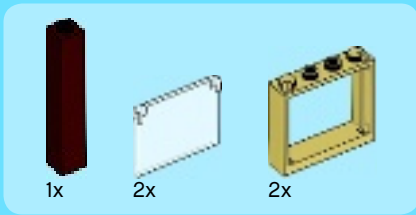

38

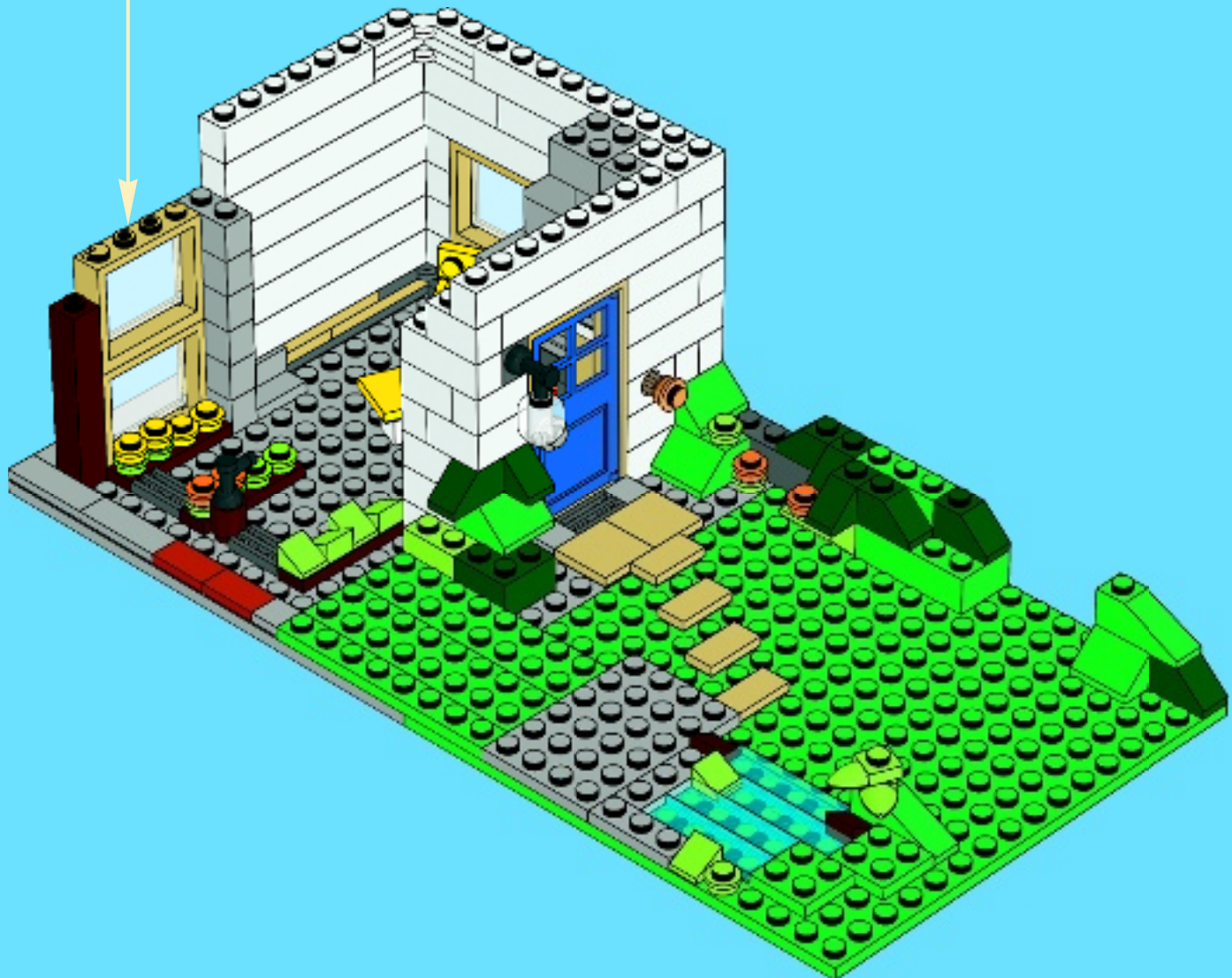
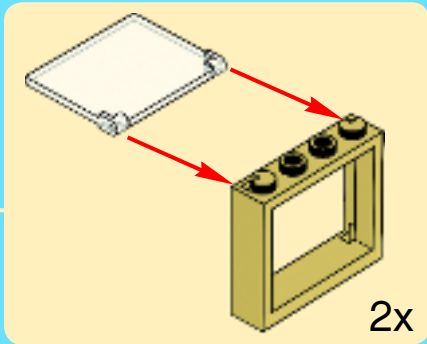

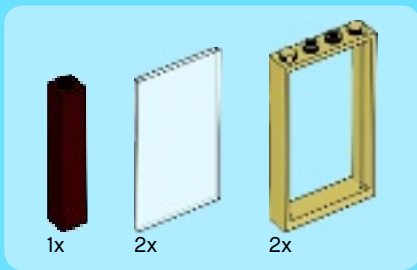

39

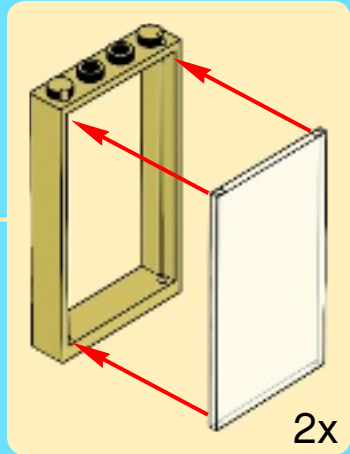

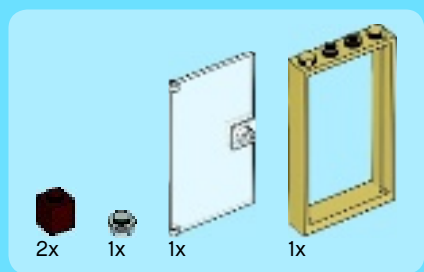

40

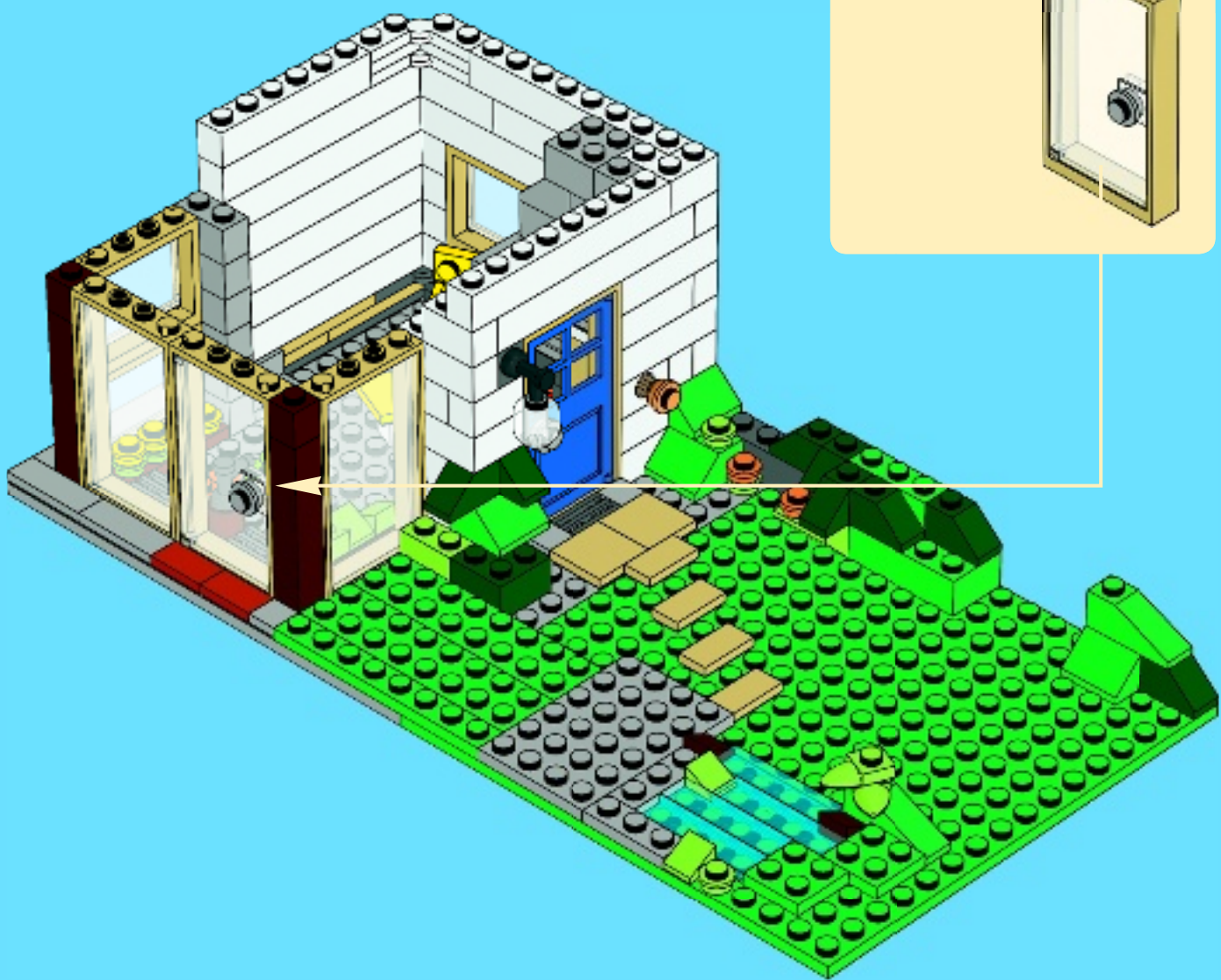
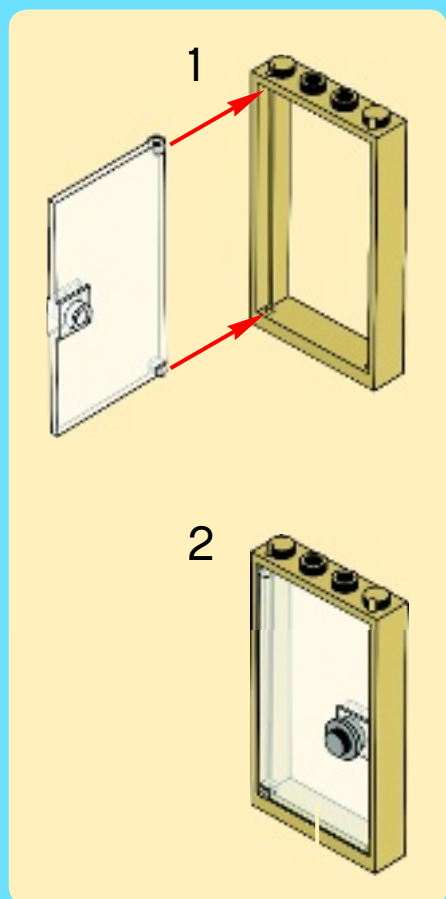

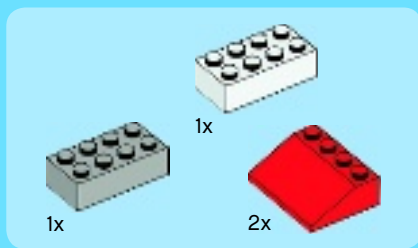

41

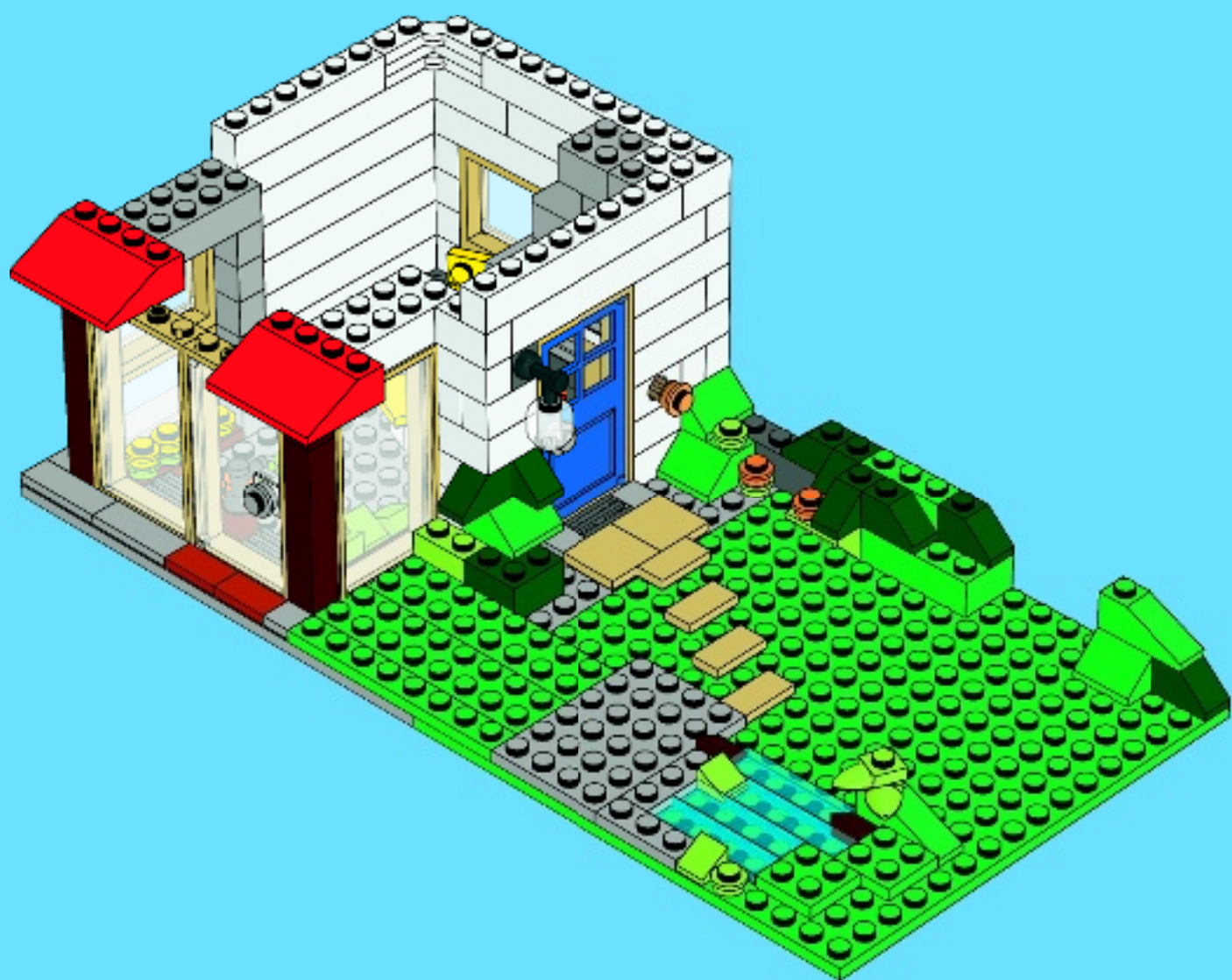

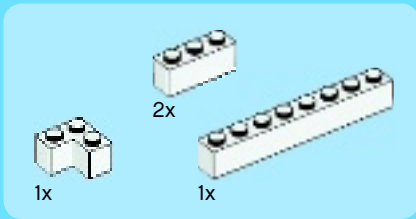

42

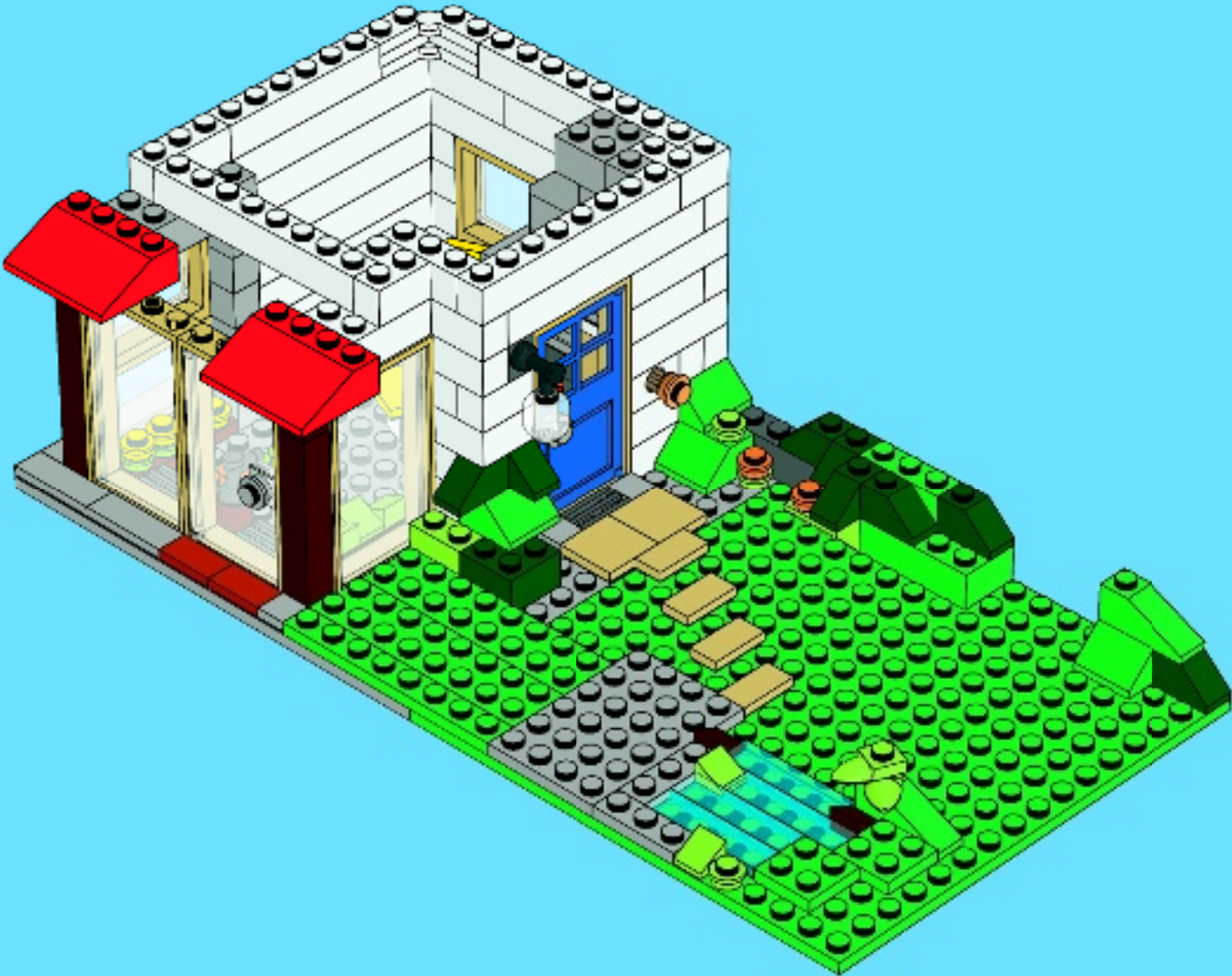



2x

43

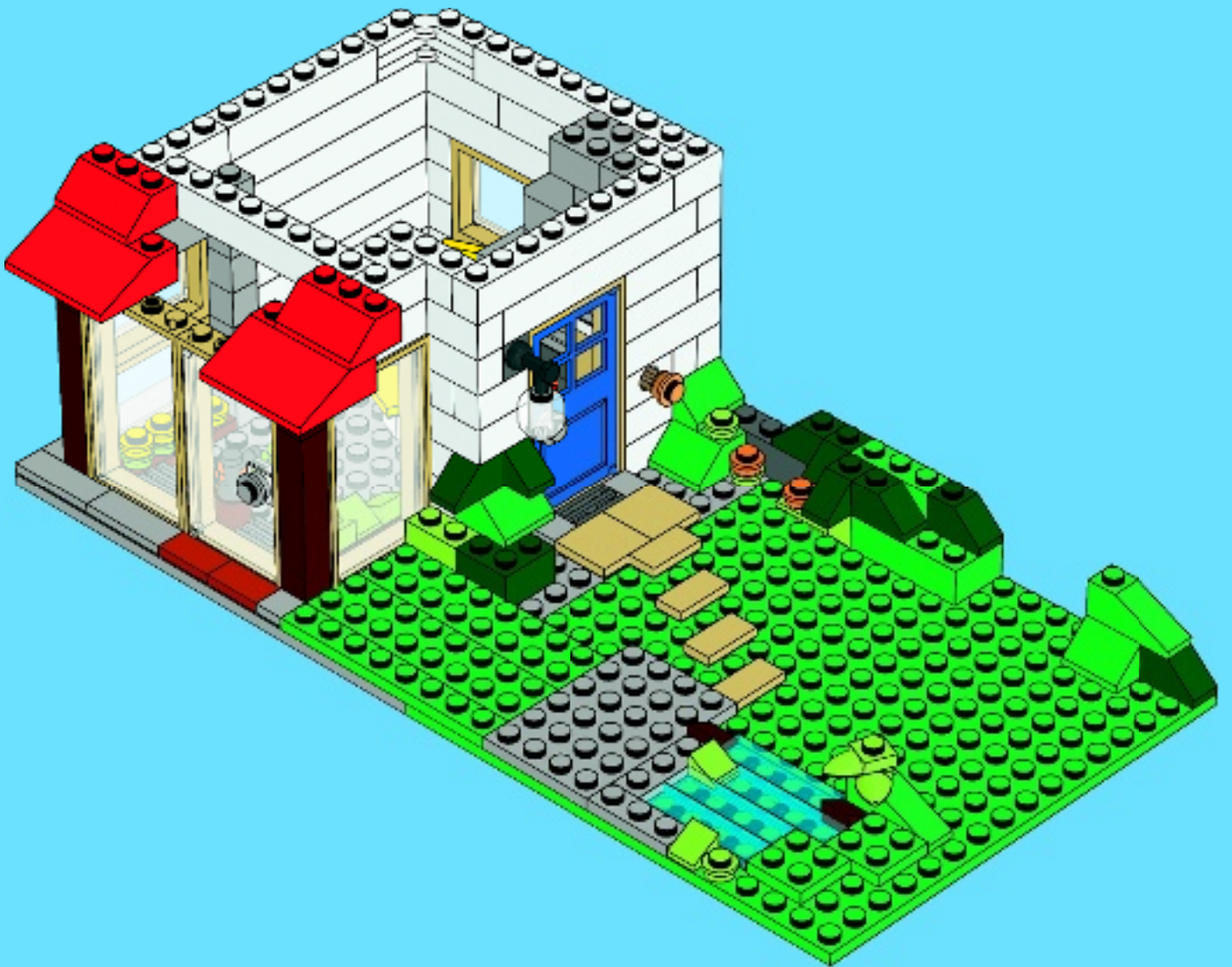



1x



2x

44

1

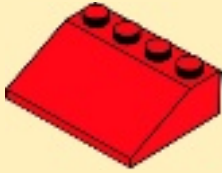

2

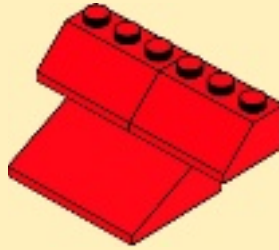

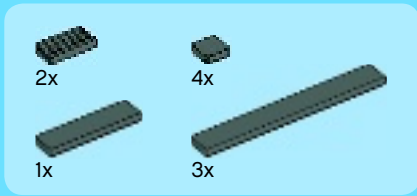

45





2x



6x



1x



1x

46



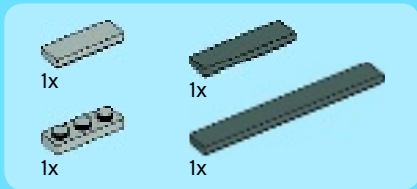

47

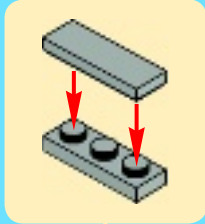

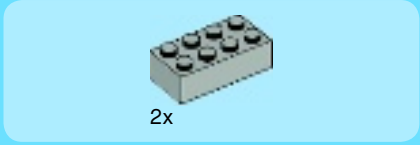
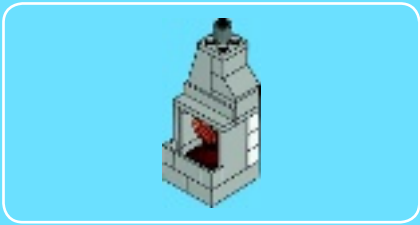

1

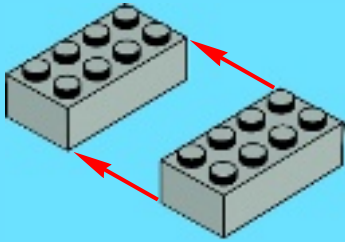

2

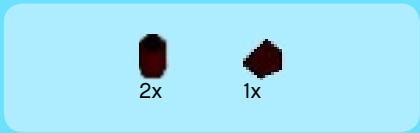

3

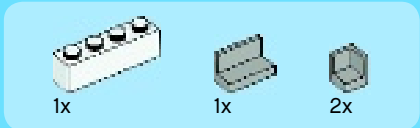

4





1x



1x

5



1x



1x

7



2x

6



1x



1x

8

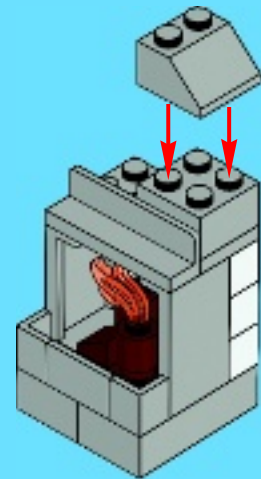



9



1x

1x

10



48





1x



2x



1x



2x



1x

49

1



2

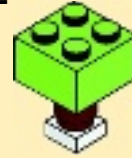

3

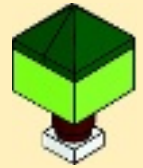



1x



1x



2x



1x



1x



2x

50

1

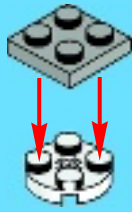

2



1

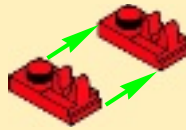

2



3



4







51

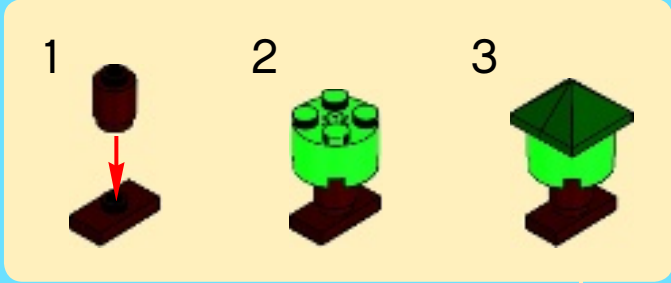



2x



1x



1x



1x



1x



1x

52

1

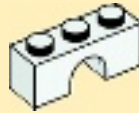

2



3

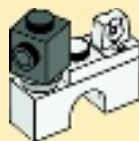

4

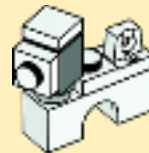

5

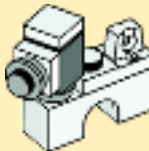

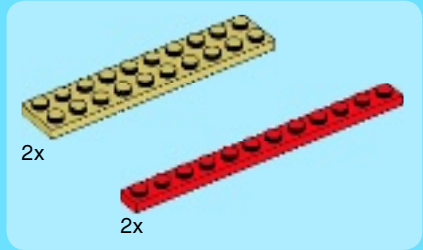

1

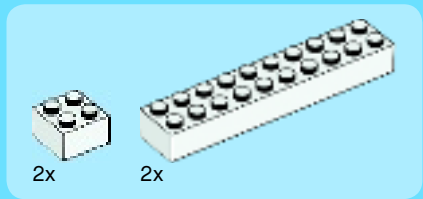
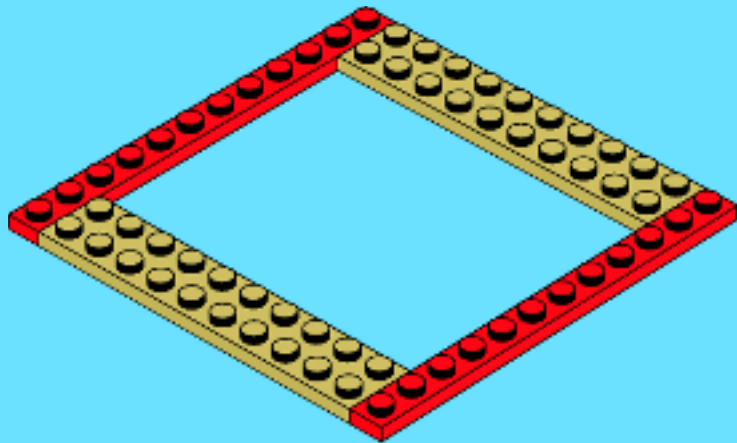

2

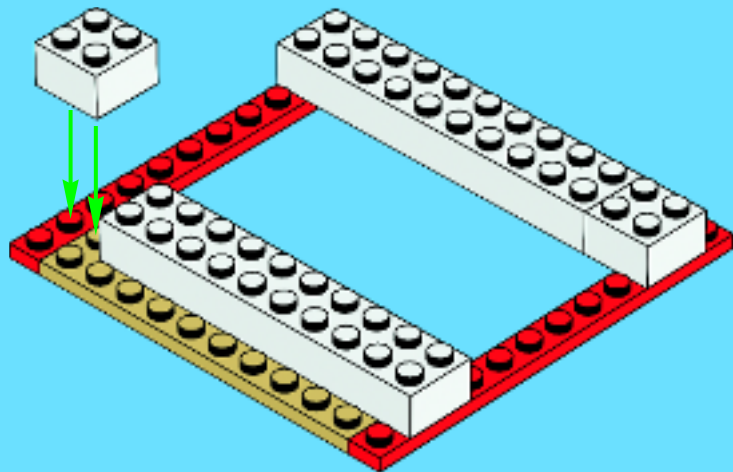



4x



4x



2x

3

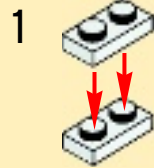

1

2

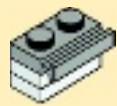

2x

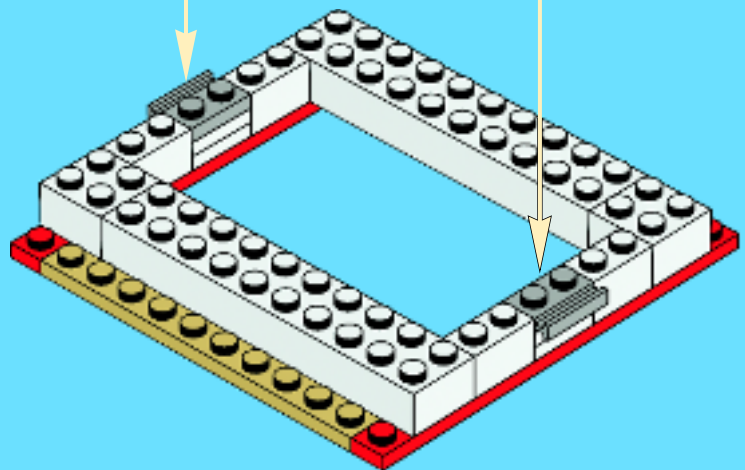

4x

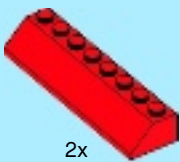

2x

4

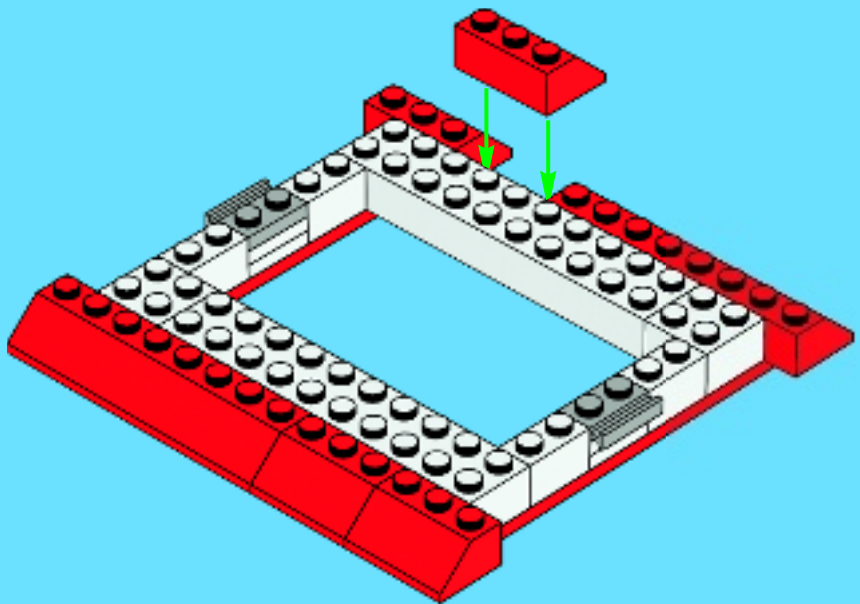



4x



2x

5

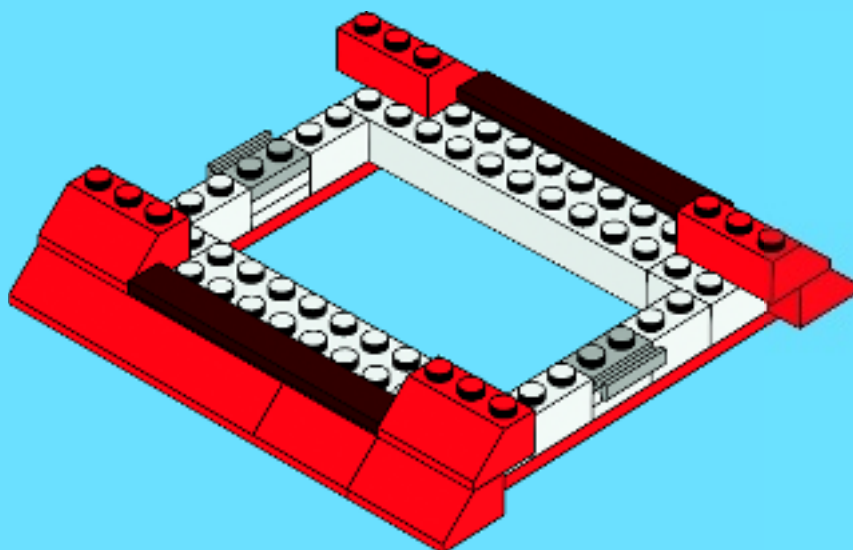

4x



4x

6

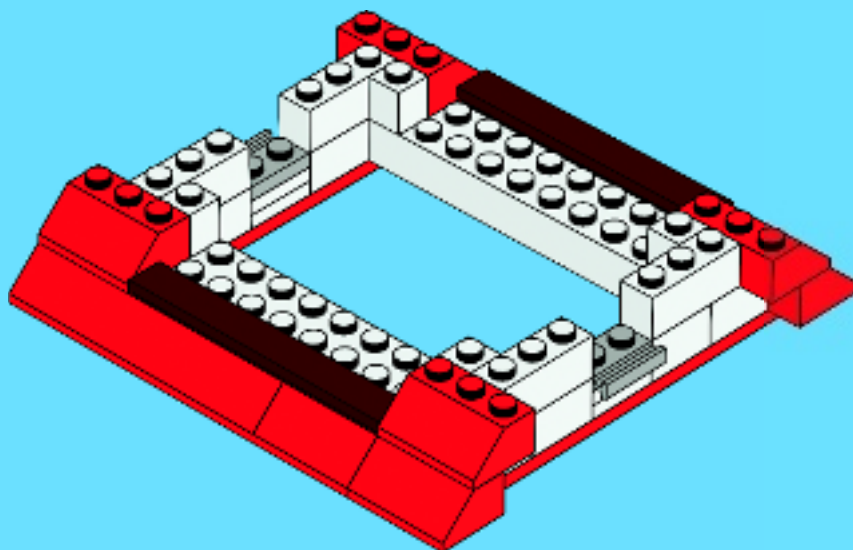

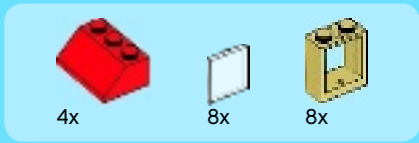

7

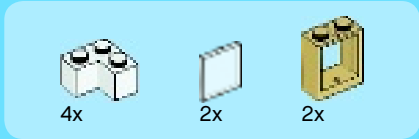
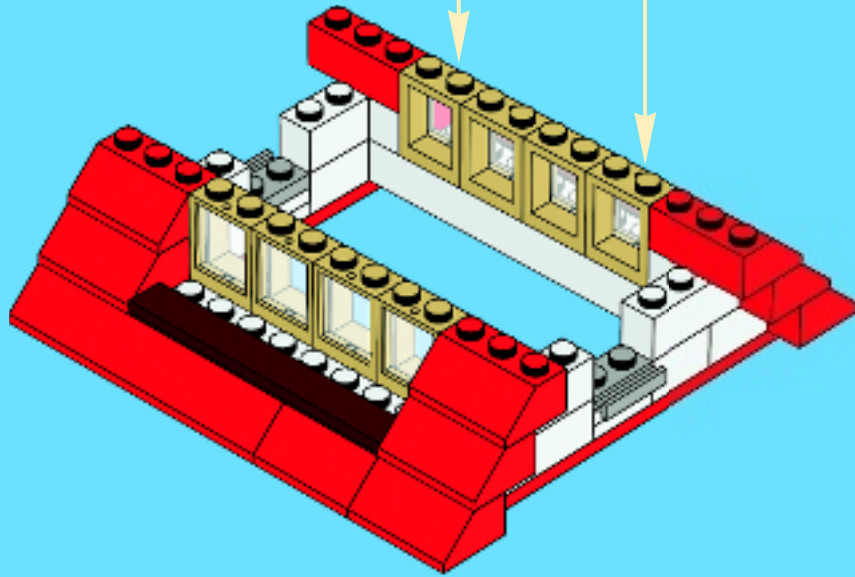
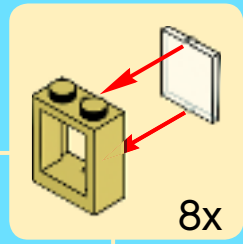

8

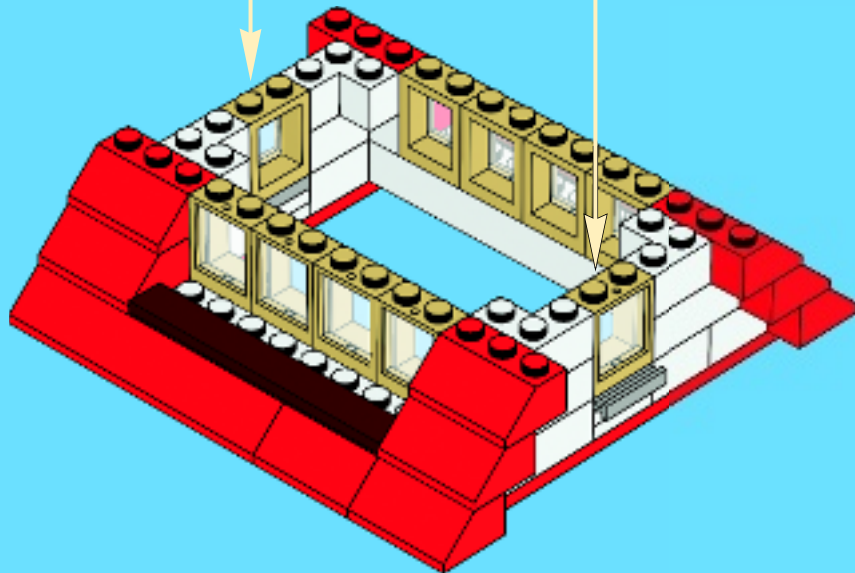
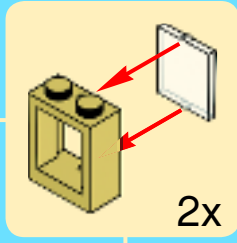



2x



2x



2x



2x

9

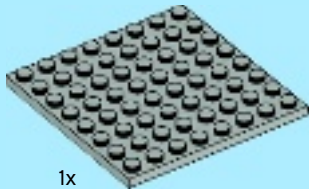
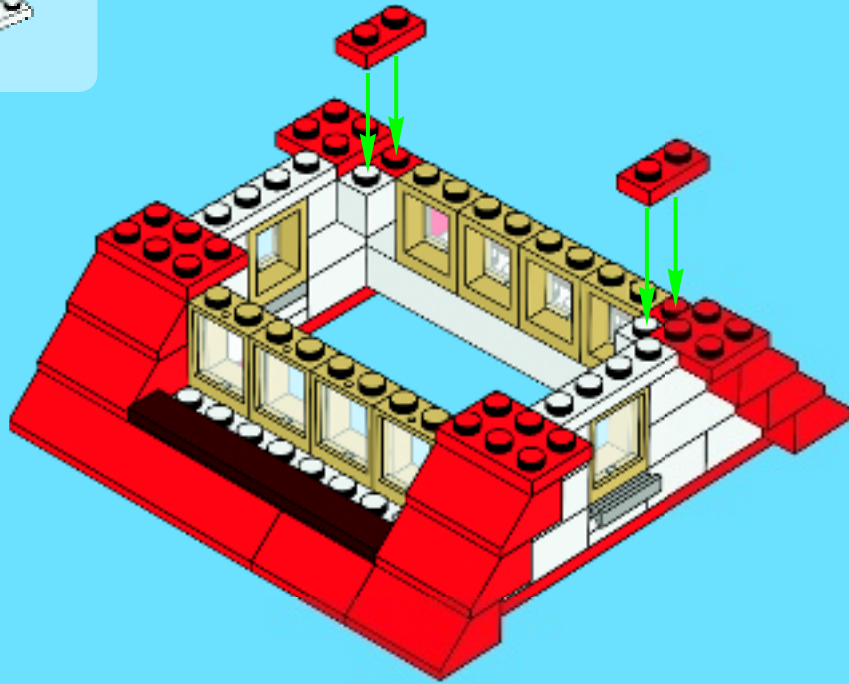

1x

10

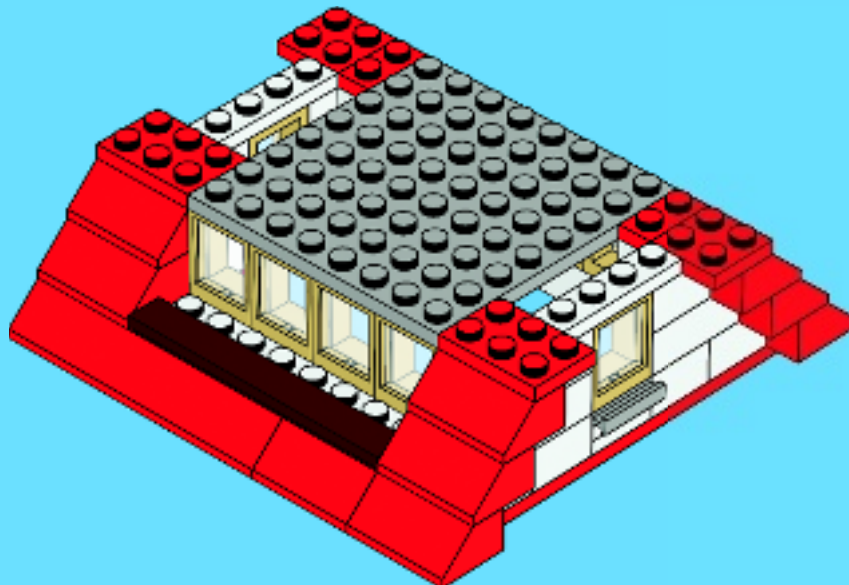

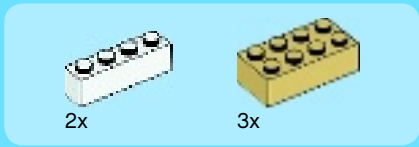

11

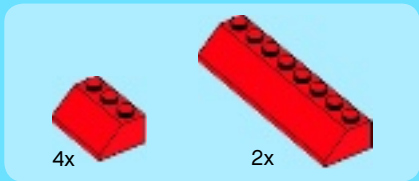
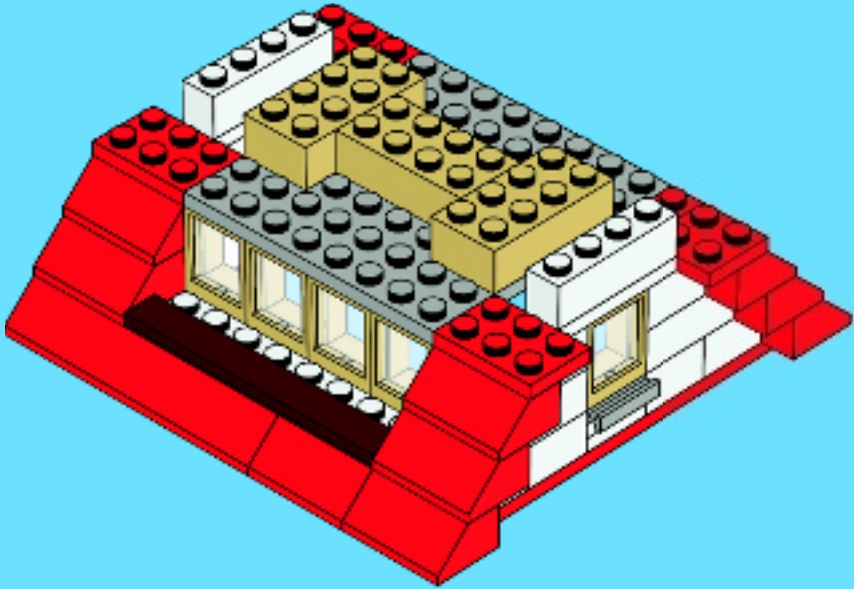

12

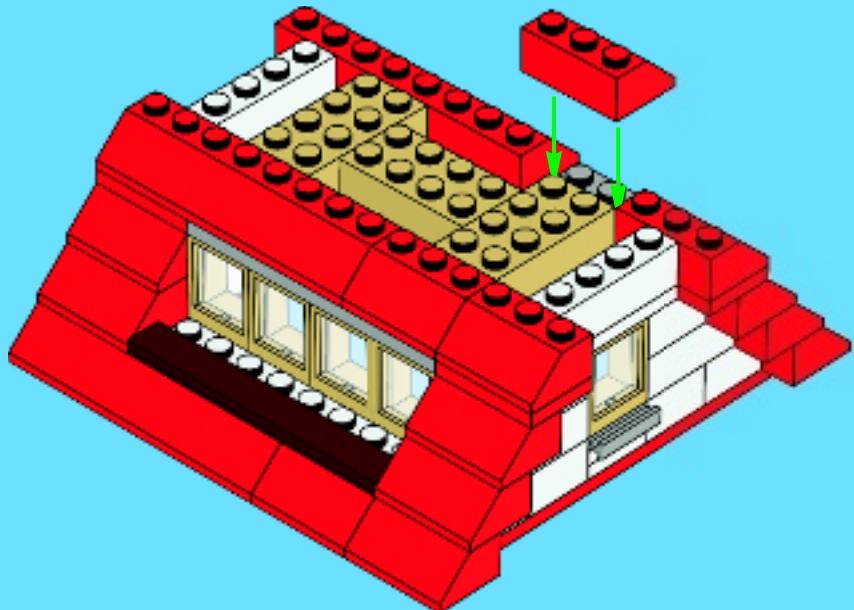

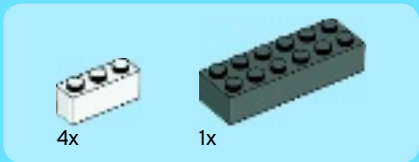

13

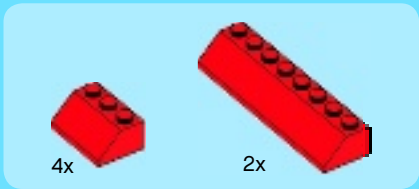
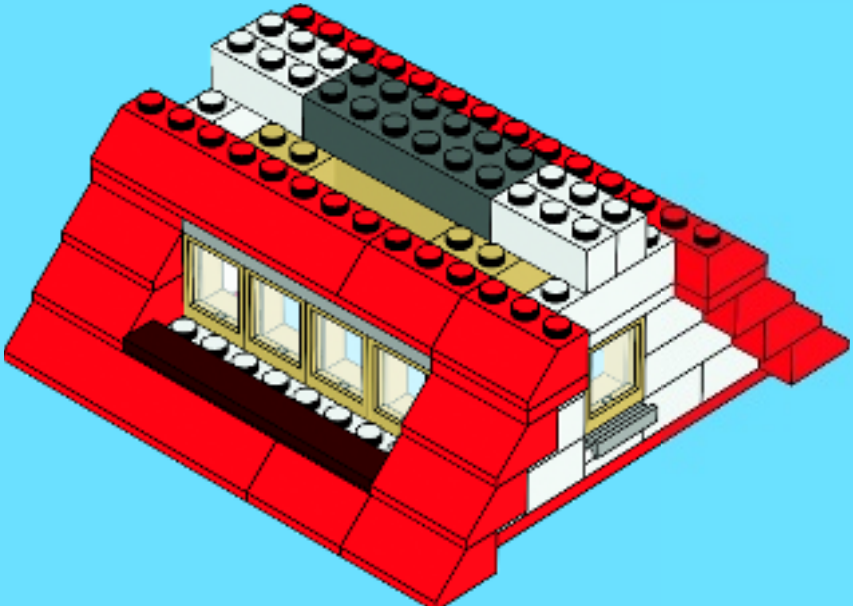

14

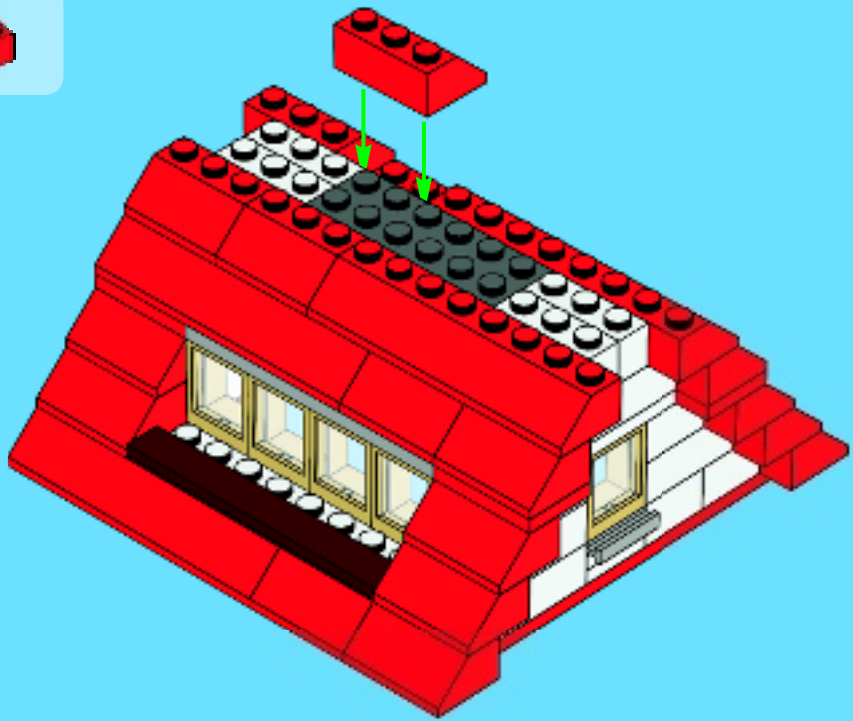



1x



3x



1x



1x

15

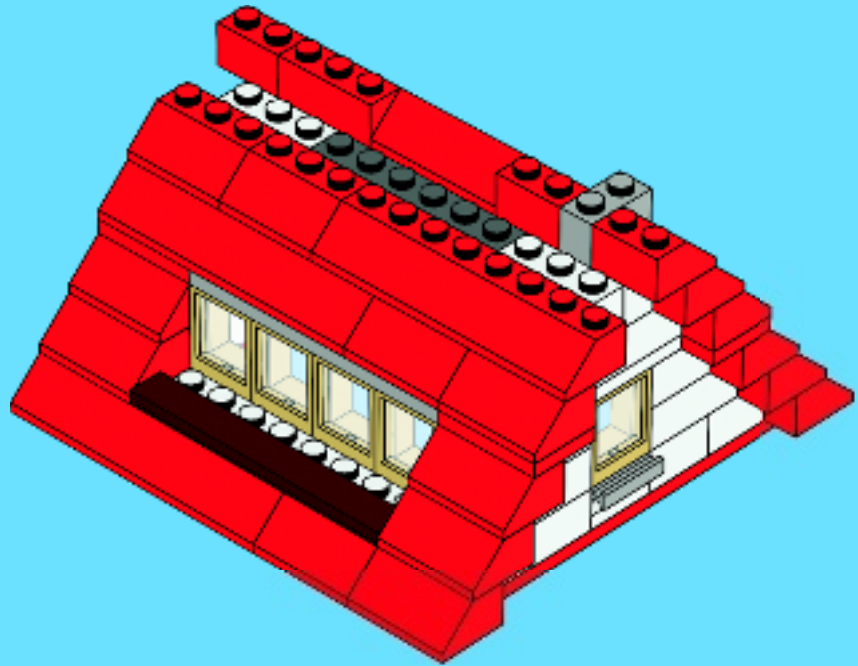

2x



1x



2x

16

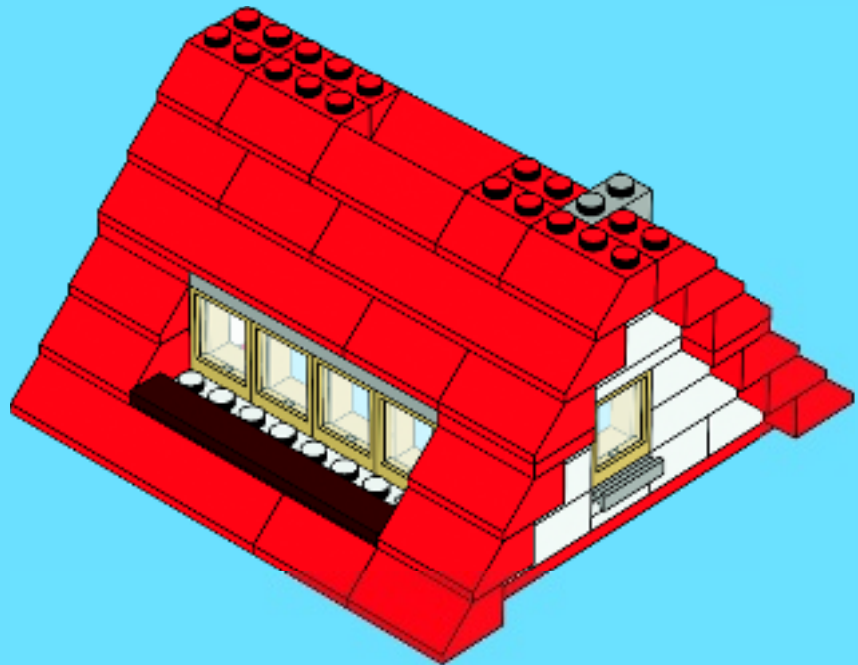



1x



1x



1x



1x

17

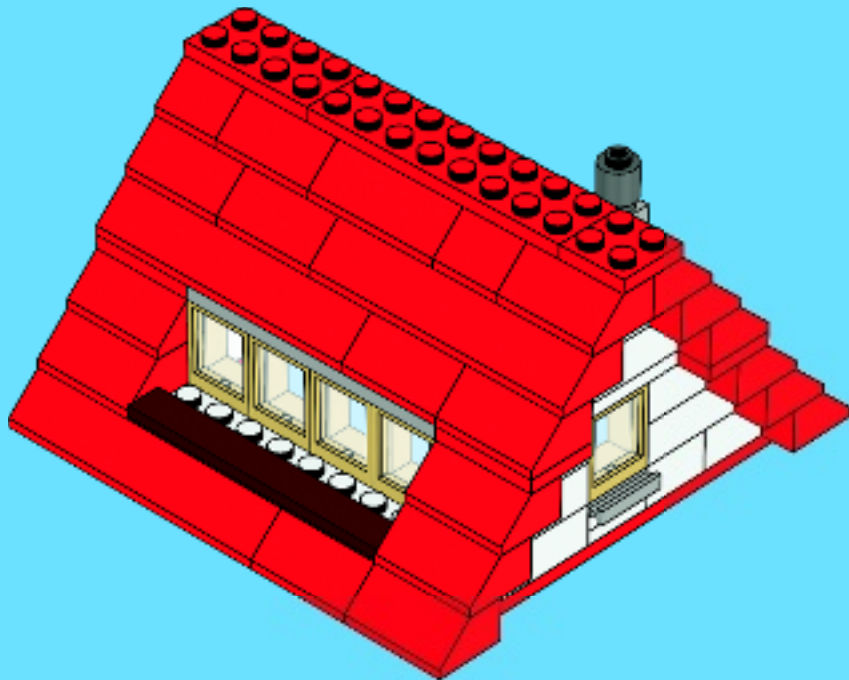

53



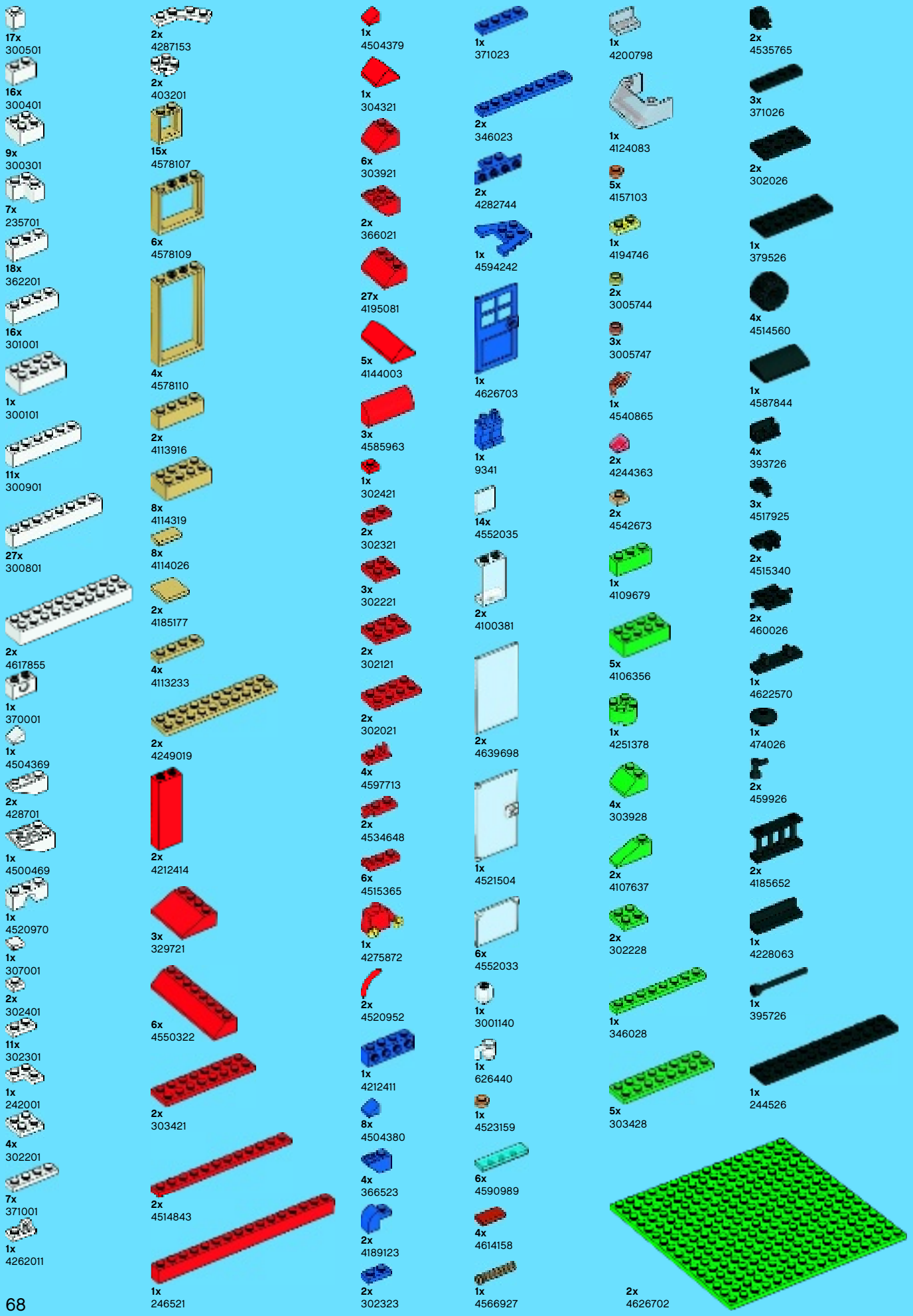

17x 300501
 16x 300401
 9x 300301
 7x 235701
 18x 362201
 16x 301001
 1x 300101
 11x 300901
 27x 300801
 2x 4617855
 1x 370001
 1x 4504369
 2x 428701
 1x 4500469
 1x 4520970
 1x 307001
 2x 302401
 11x 302301
 1x 242001
 4x 302201
 7x 371001
 1x 4262011

2x 4287153
 2x 403201
 15x 4578107
 6x 4578109
 4x 4578110
 2x 4113916
 8x 4114319
 8x 4114026
 2x 4185177
 4x 4113233
 2x 4249019
 2x 4212414
 3x 329721
 6x 4550322
 2x 303421
 2x 4514843
 1x 246521

1x 4504379
 1x 304321
 6x 303921
 2x 366021
 27x 4195081
 5x 4144003
 3x 4585963
 1x 302421
 2x 302321
 3x 302221
 2x 302121
 2x 302021
 4x 4597713
 2x 4534648
 6x 4515365
 1x 4275872
 2x 4520952
 1x 4212411
 8x 4504380
 4x 366523
 2x 4189123
 2x 302323

1x 371023
 2x 346023
 2x 4282744
 1x 4594242
 1x 4626703
 1x 9341
 14x 4552035
 2x 4100381
 2x 4639698
 1x 4521504
 6x 4552033
 1x 3001140
 1x 626440
 1x 4523159
 6x 4590989
 4x 4614158
 1x 4566927

1x 4200798
 1x 4124083
 5x 4157103
 1x 4194746
 2x 3005744
 3x 3005747
 1x 4540865
 2x 4244363
 2x 4542673
 1x 4109679
 5x 4106356
 1x 4251378
 4x 303928
 2x 4107637
 2x 302228
 1x 346028
 5x 303428
 2x 4626702

2x 4535765
 3x 371026
 2x 302026
 1x 379526
 4x 4514560
 1x 4587844
 4x 393726
 3x 4517925
 2x 4515340
 2x 460026
 1x 4622570
 1x 474026
 2x 459926
 2x 4185652
 1x 4228063
 1x 395726
 1x 244526

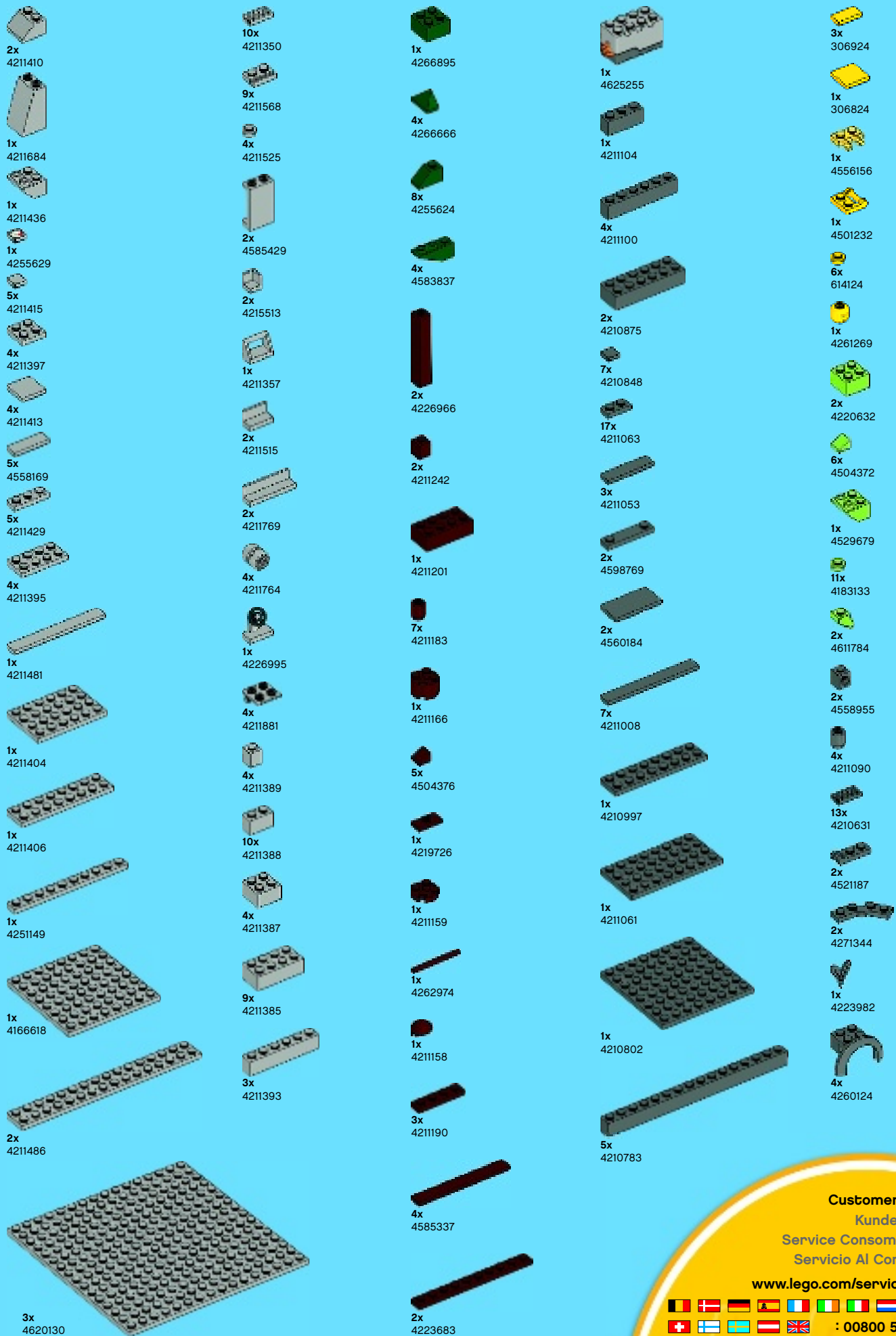

Customer Service
Kundenservice
Service Consommateurs
Servicio Al Consumidor

www.lego.com/service or dial



: 00800 5346 5555
 : 1-800-422-5346

LEGO club™

FREE! GRATIS! GRATUIT!



www.LEGOclub.com



LEGO® Club Magazine



LEGO® Club Email

SIGN UP ONLINE!

www.LEGOclub.com

VISIT THE WORLD'S
BIGGEST LEGO® SHOP!

www.LEGOshop.com

GO TO
www.LEGOclub.com

00800 5346 5555*

1-866-534-6258 • 1-877-518-5346

US & Canada only

Canada seulement



* Freephone. Mobile charges may apply. * Numéro sans frais. Des frais peuvent s'appliquer avec les téléphones cellulaires. * Gebührenfrei, Kosten für Anrufe aus Mobilfunknetzen können abweichen. * Gratis telefoonnummer vanaf vaste lijn. * Det er et gratis nummer, når du ringer fra fasttelefon. * Det är gratis, när du ringer från en fast telefon. * Numéro sans frais. Des frais peuvent s'appliquer avec les téléphones portables.

YES! I want to join the LEGO® Club FREE! **OUI!** Je veux m'abonner au LEGO® Club GRATUITEMENT !

Ja! Ich möchte Mitglied im kostenlosen LEGO® Club werden. **Ja!** Ik wil graag GRATIS lid worden van de LEGO® Club.

Ja! Jeg ønsker å melde meg inn i LEGO® Club gratis! **Ja!** Jag vill gå med i LEGO® Club GRATIS!

First name · Prénom
Vorname · Voornaam
Fornavn · Förnamn

Last name · Nom de famille
Name · Achternaam
Etternavn · Efternamn

Date of Birth · Date de naissance
Geburtsdag · Geboortedatum
Fødselsdato · Födelsedatum

Boy · Garçon · Junge ·
Jongen Gutt · Pojke

Girl · Fille Mädchen ·
Meisje Jente · Flicka

Street · Adresse
Straße, Hausnr.
Straat, huisnr. ·
Address

City · Ville
Ort · Woonplaats
Poststed · Postort

State
Prov.
County

Zip/Postcode · Code
Postal · PLZ · Postcode ·
Postnummer

Country
Pays ·
Land

Email · Courriel ·
E-Mail · E-post

Fill in your email address and we will send you a membership confirmation and monthly email newsletters. If you do not wish to receive the newsletters please tick here. Remplis ton adresse e-mail et nous t'enverrons une confirmation d'adhésion ainsi que le bulletin e-mail mensuel. Si tu ne désires pas recevoir le bulletin, coche cette case. Vul je e-mailadres in en we sturen je een bevestiging van je lidmaatschap en maandelijke e-mail nieuwsbrieven. Als je geen e-mail wilt ontvangen, kruis dan dit vakje aan.

Ich möchte per E-Mail den monatlichen LEGO Club Newsletter erhalten. Ønsker du at vi skal sende en liten hilsen til barnet ditt for å bekrefte medlemskapet, ber vi deg krysse av i feltet, samt oppgi e-postadressen som hilsenen skal sendes til. Om du vill att vi ska skicka en bekräftelse på ditt barns medlemskap, ber vi dig sätta ett kryss i rutan och skriva den e-post adress som bekräftelsen ska skickas till.

If you do not wish to receive additional mailings from the LEGO Club please tick here. Si tu ne désires pas recevoir de courrier supplémentaire du Club LEGO, coche cette case. Als je geen verdere post van de LEGO Club wilt ontvangen, kruis dan dit vakje aan.

Dersom du ønsker å motta annen informasjon fra LEGO Gruppen, setter du et kryss her.

Mail to: / Poster à:



LEGO® Club
P.O. Box 1157
Enfield, CT USA
06083-1157

Per Post an:



LEGO® Club
Postfach 14 15
D-36243 Niederaula

Send til:



LEGO® Club Norge
Postboks 58
1314 Vøyenenga

Mail to:



LEGO® Club
33 Bath Road
Slough SL1 3UF
United Kingdom

Stuur op naar:



LEGO® Club
Postbus 40250
3504 AB Utrecht

Skickas till:



LEGO® Club Sverige
Ubox 841
202 29 Malmö

Poster à:



LEGO® Club
21 rue de la banque
75 002 PARIS
FRANCE

The English language version of the magazine can only be mailed to addresses in the US, Canada, the UK, and Republic of Ireland. Club membership is valid for two years and includes free copies of the LEGO Club Magazine and e-mail newsletters. In the US and Canada please allow up to 6 weeks for delivery of your first magazine. In the UK and Republic of Ireland please allow six to 14 weeks for delivery of your first magazine. By signing this form you consent the LEGO Club to use your child's data for LEGO mailings. The data will only be used for LEGO mailings and will not be sold, rented or otherwise disclosed to any company outside the LEGO Company except for disclosure to companies acting as our agents to help us provide services requested by the child. This coupon is valid for one free membership per person, group or organization. Photocopied coupons are accepted. La version française du magazine peut être postée uniquement au Canada. L'abonnement est valide pour 2 ans et inclut des exemplaires gratuits du Magazine LEGO. Aux É.-U. et au Canada, allouer 6 semaines pour la livraison initiale. En remplissant ce formulaire, vous consentez à ce que LEGO utilise les informations de votre enfant pour des envois postaux de LEGO. L'information sera utilisée uniquement pour des envois postaux par LEGO et ne sera en aucun cas, vendue, louée, échangée ou divulguée à d'autres compagnies autres que la compagnie LEGO, à l'exception des compagnies affiliées qui nous procurent des services auxquels l'enfant en a fait la demande. Formulaire photocopié accepté. Mit der folgenden Unterschrift erkläre ich, für mein Kind den Beitritt als Mitglied zum kostenlosen LEGO Club, der von der LEGO GmbH, D-85627 Grasbrunn, betrieben wird. Die Mitgliedschaft beinhaltet die Zusendung des LEGO Club Magazins und kann beiderseits jederzeit beendet werden. Mit der Mitgliedschaft im LEGO Club sind keinerlei Verpflichtungen verbunden. Das deutschsprachige LEGO Club Magazin wird nur an Adressen in Deutschland, Österreich und der Schweiz versendet. Eine Anmeldebestätigung kann nur per E-Mail geschickt werden. Das Magazin erscheint fünfmal jährlich. Daher kann die Zustellung des ersten Heftes bis zu drei Monate dauern. Die Mitgliedschaft ist beidseitig jederzeit kündbar, ohne dass Ihnen Kosten entstehen. Sie können der werblichen Nutzung Ihrer Daten jederzeit widersprechen. Kündigung und Widerspruch können Sie telefonisch erklären (00800 / 5346 5555, Anruf gebührenfrei, Kosten für Anrufe aus dem Mobilfunknetz können abweichen) oder an die LEGO GmbH senden. Het Nederlandse LEGO Club Magazine kan alleen worden gestuurd naar adressen in Nederland. Het lidmaatschap is 2 jaar geldig en geeft recht op toezending van het gratis LEGO Club Magazine en LEGO Club e-mails. Het eerste magazine zal binnen 12 tot 14 weken toegestuurd worden. Het lidmaatschap kan op ieder moment opgezegd worden en kan na 2 jaar gratis worden verlengd, tenzij LEGO met deze activiteit stopt. Uw gegevens worden uitsluitend gebruikt voor mailings van LEGO en zullen niet worden verkocht, verhuurd of op welke wijze dan ook verstrekt aan derden buiten de LEGO Groep, uitgezonderd de organisaties die namens ons optreden om de informatie te sturen waarvoor toestemming is verleend. Den norske utgaven av magasinet sendes kun til adresser i Norge. Medlemskap i klubben gjelder i 2 år og inkluderer gratisutgaver av LEGO Club Magazine. Pærgen minimum optil seks uker leveringstid for første magasin. Ved å undertegne dette skjemaet, gir du ditt samtykke til at LEGO Club kan bruke opplysningene om barnet ditt i LEGO forsendelser. Dataene vil utelukkende bli brukt i LEGO forsendelser og vil ikke bli solgt, utleid eller på annen måte gjøres tilgjengelig for selskaper utenfor LEGO gruppen, unntatt selskaper som er våre agenter og som hjelper oss å tilby tjenestene barnet etterspør. Dette skjemaet gjelder for ett gratis medlemskap per person, gruppe eller organisasjon. Den svenska versionen av tidningen kan endast skickas till adresser i Sverige. Club-medlemskapet är giltigt i 2 år och innefattar gratis exemplar av LEGO Club Magazine. Vänligen räkna med minimum 6 veckor för leverans av din första tidning. Genom att skicka in det här formuläret godkänner du att LEGO Club använder barnets uppgifter för LEGO utskick. Uppgifterna kommer bara att användas för LEGO utskick och kommer inte att säljas, hyras ut eller vidarebefordras till något företag som inte tillhör LEGO Gruppen, med undantag av företag som agerar som våra ombud för att tillhandahålla tjänster som barnet har begärt. Den här kupongen gäller för ett gratis medlemskap per person, grupp eller organisation. En complétant ce bulletin d'adhésion, vous acceptez que LEGO Club utilise les données relatives à votre enfant pour l'envoi de courriers concernant LEGO. Ces données seront uniquement utilisées pour l'envoi d'information concernant LEGO et ne seront ni vendues, ni louées, ni utilisées par d'autres sociétés que le groupe LEGO, à l'exception des sociétés agissant pour le compte de LEGO en tant que sous-traitant de services divers. L'abonnement au LEGO Club est valable pour une période de 2 ans. Il inclut l'envoi par courrier du magazine LEGO Club et par email des newsletters. Un délai de 6 à 14 semaines est à prévoir pour la réception de votre premier magazine. Ce bulletin d'adhésion gratuit est valable pour l'inscription d'une seule personne. Les photocopies sont acceptées. ATTENTION! Le bulletin d'adhésion doit être rempli et signé par un parent ou un tuteur.

Parent's signature · Signature d'un parent ou d'un tuteur
• Unterschrift Erziehungsberechtigte/r · Handtekening ouders
• Foreldres/foresattes underskrift · Förälders /förmyndares underskrift

Date
Datum
Dato

10216



+



10222



www.LEGO.com



CREATOR



5764



5763



5765





CREATOR

5766





CREATOR

5770



creator.LEGO.com





creator.LEGO.com/designers

creator.LEGO.com/movies

