

The LEGO logo is displayed in its characteristic white font with a black outline, set against a red rectangular background.The word "CITY" is written in a large, bold, white font with a black outline, positioned to the right of the LEGO logo.

60277



WARNING: CHOKING HAZARD.
Toy contains small parts and a small ball.
Not for children under 3 years.





- 1** Scan the code on the front cover
Scanne den Code auf der Titelseite
Scanne le code sur la page de couverture
Scanner le code sur la page couverture
Scansiona il codice sulla copertina
Escanea el código de la portada
Faz scan do código na frente da capa
Olvasd be a borítón látható kódot!
Noskenë kodu uz priekšējā vāka
扫描封面上的二维码



- 2** Get Instructions PLUS
Hol dir Instructions PLUS
Obtiens les instructions PLUS
Obtenir les Instructions PLUS
Scarica Instructions PLUS
Descubre Instructions PLUS
Obtém Instruções PLUS
Szerezd be az Instructions PLUS kiegészítőt!
Sanjem "Instructions PLUS"
获取更多说明

LEGO.com/apps

Check for compatibility
Kompatibilität prüfen
Vérifier la compatibilité
Controlla la compatibilità
Comprueba tu compatibilidad

Verificar a compatibilidade
Ellenőrizd a kompatibilitást
Pārbaudīt saderību
检查兼容性

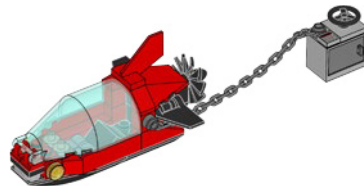
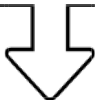



AVERTISSEMENT :
RISQUE D'ÉTOUFFEMENT.

Le jouet contient des petites pièces ainsi qu'une petite boule. Il ne convient pas aux enfants de moins de 3 ans.



ADVERTENCIA:
PELIGRO DE ASFIXIA.

Juguete que contiene partes pequeñas y una pelota pequeña. No recomendado para niños menores de 3 años.

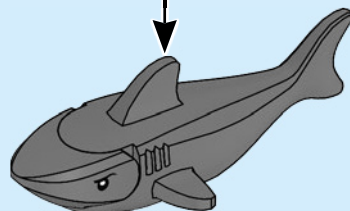
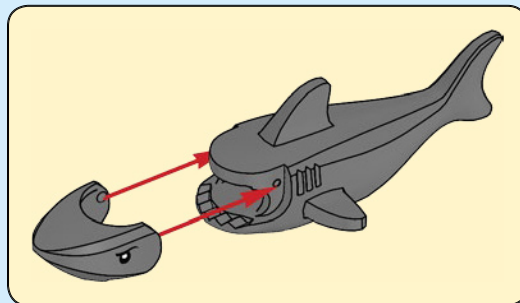

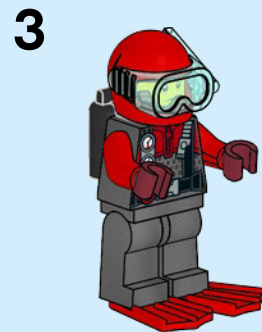
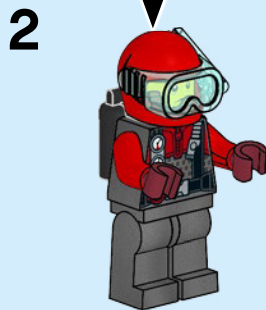
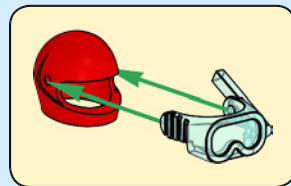
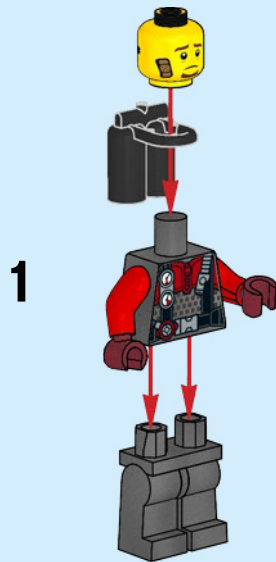

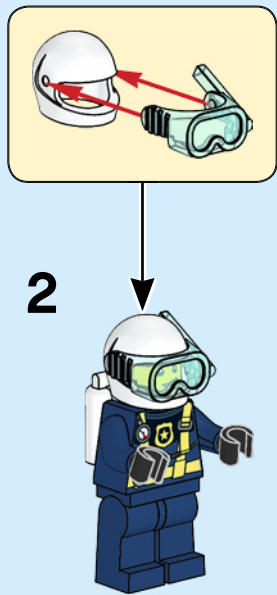
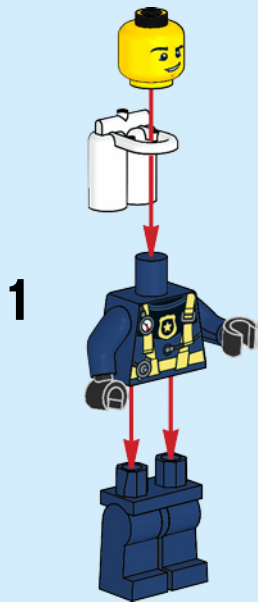



1x

1

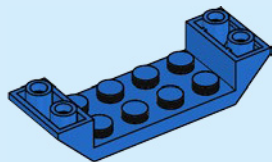

2x

2

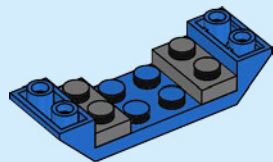

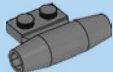

2x

3

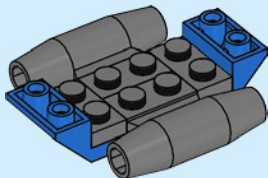

8

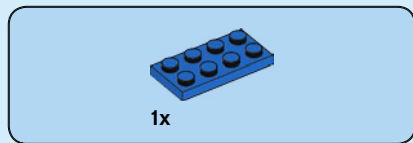

4

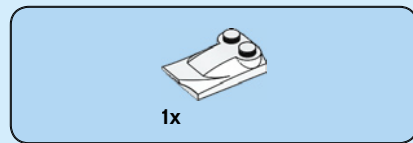
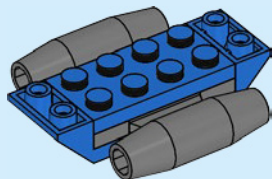

5

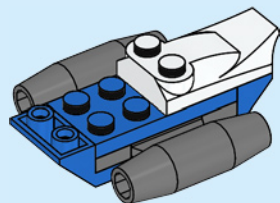



1x

6

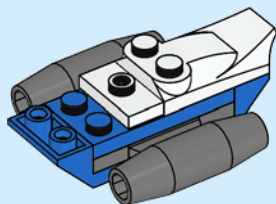



2x

7

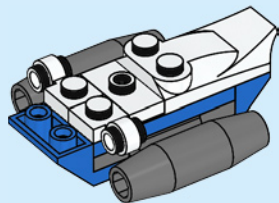

1x

8

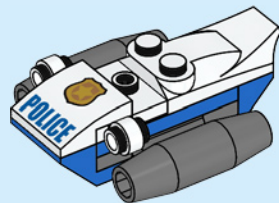



2x

9

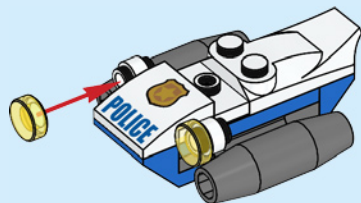



1x



1x

10

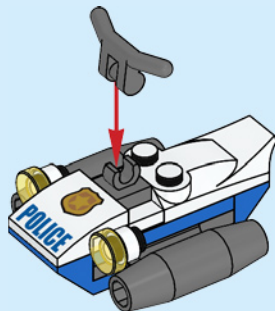
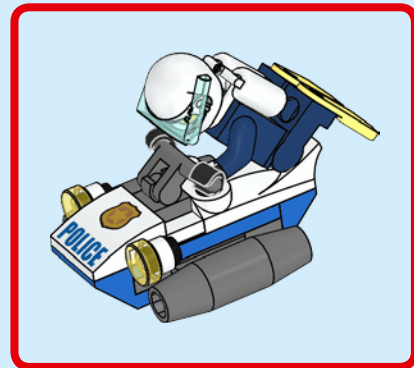

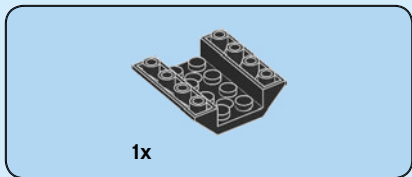
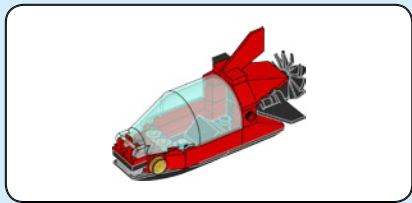

1

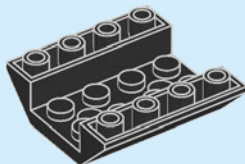

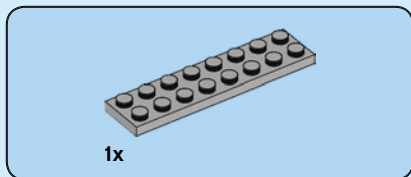

2

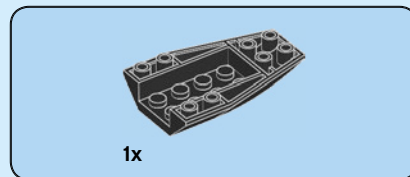
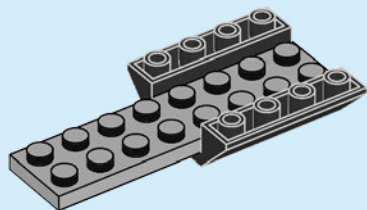

3

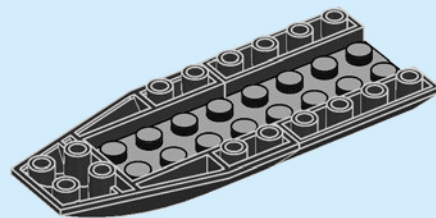

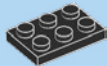

1x

4

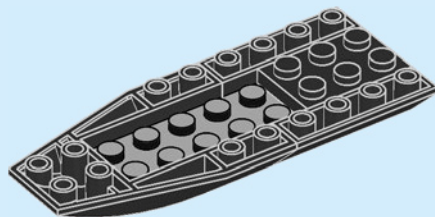

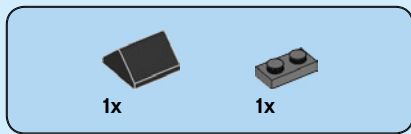

5

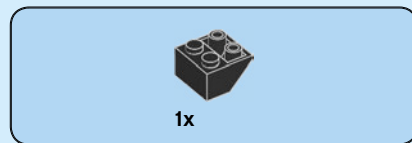
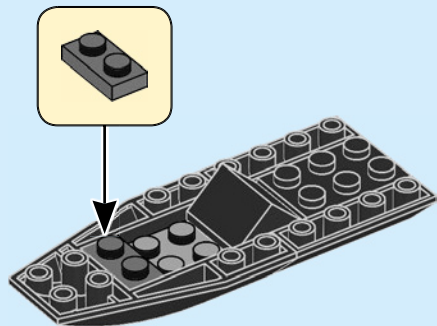

6

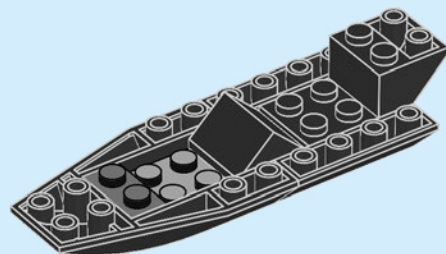



2x

7

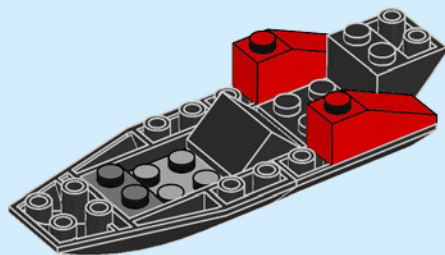



1x

8

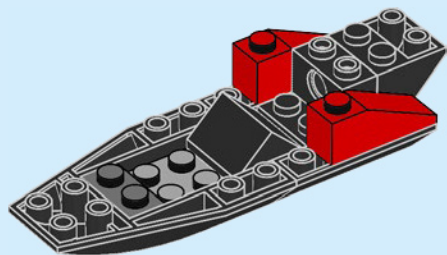

2x

9

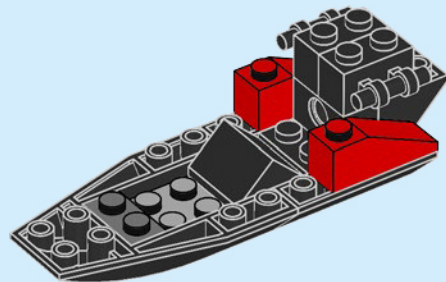

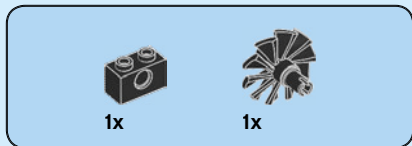

10

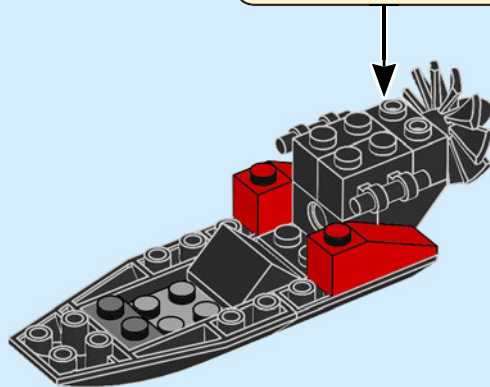
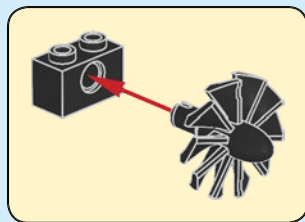



11

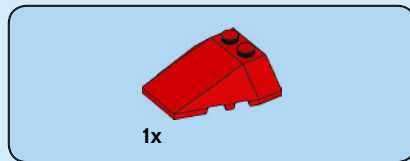
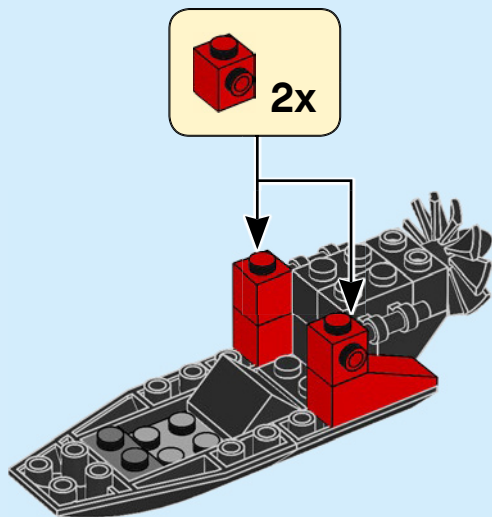

12

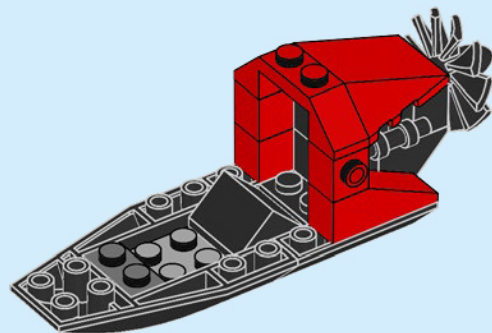

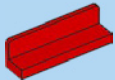

2x

13

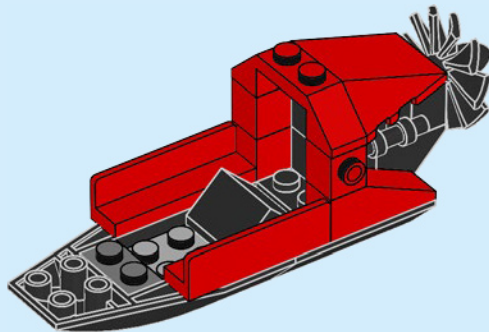

22



2x



1x

14

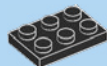
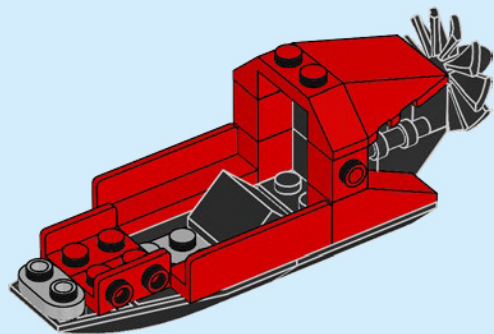

1x

15

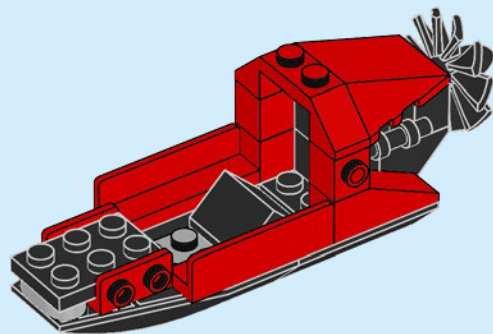



2x



2x

16

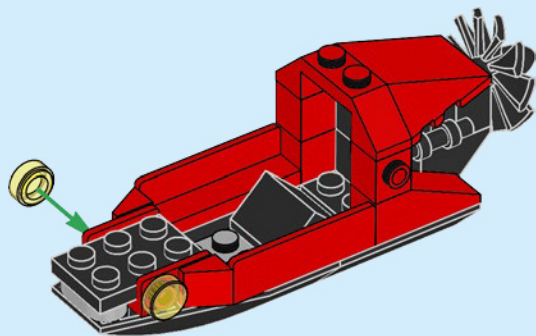



2x

17

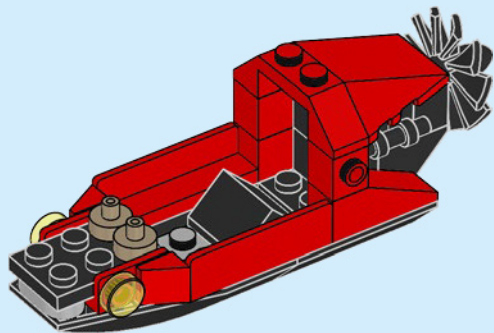

2x

18

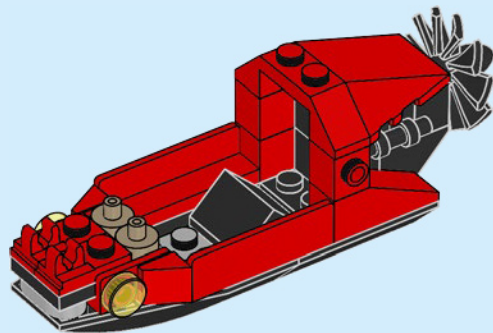



2x

19

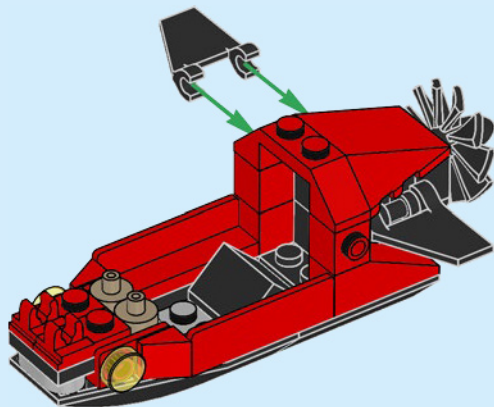

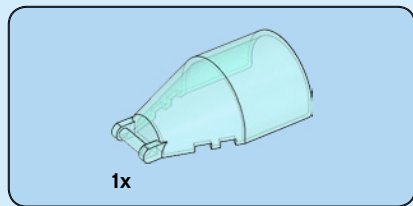

20

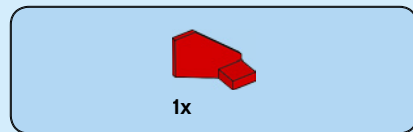
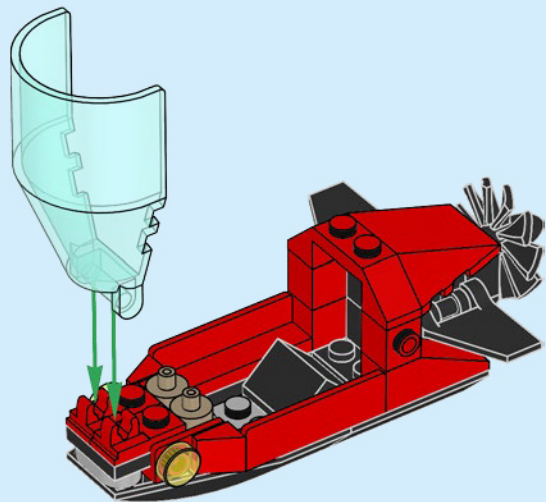

21

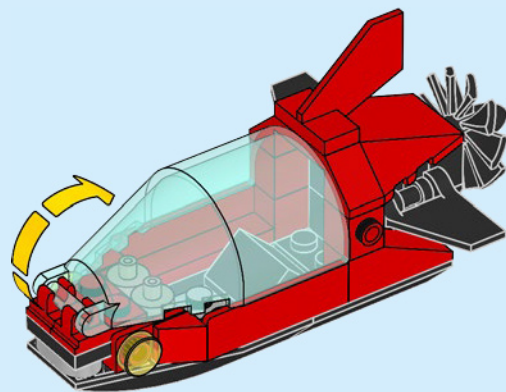

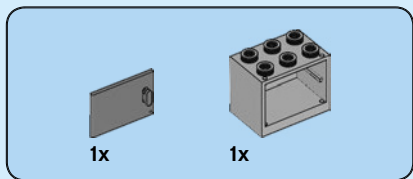
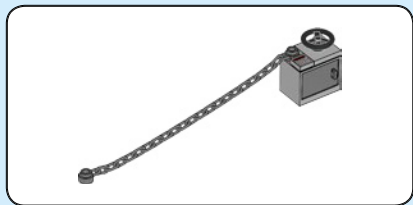

22

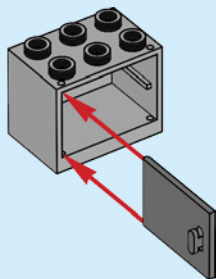

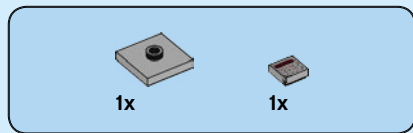

23

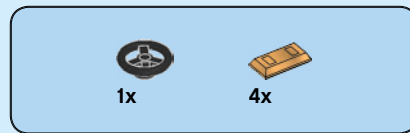
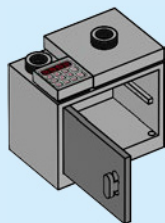

24

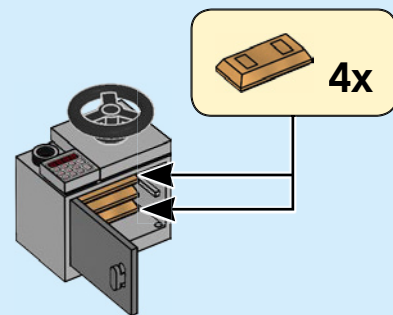

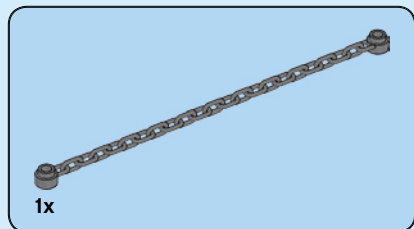

25

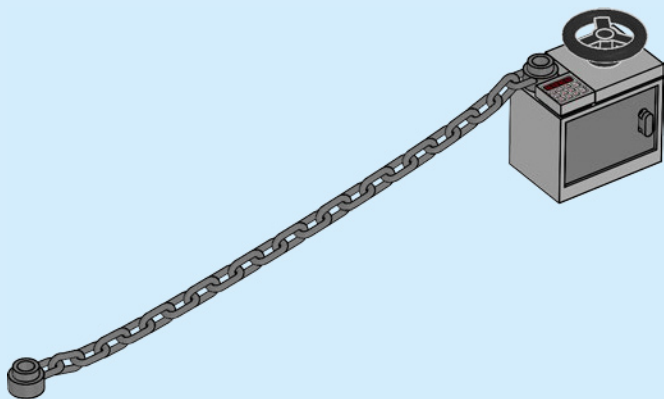

26

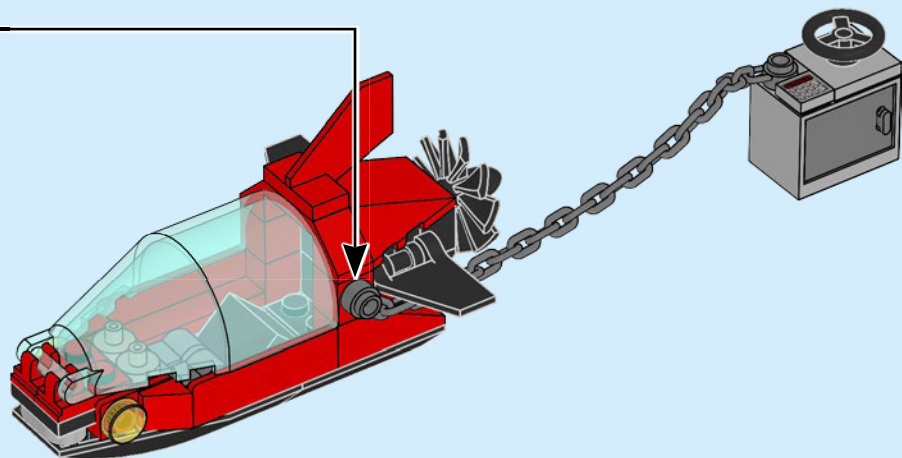

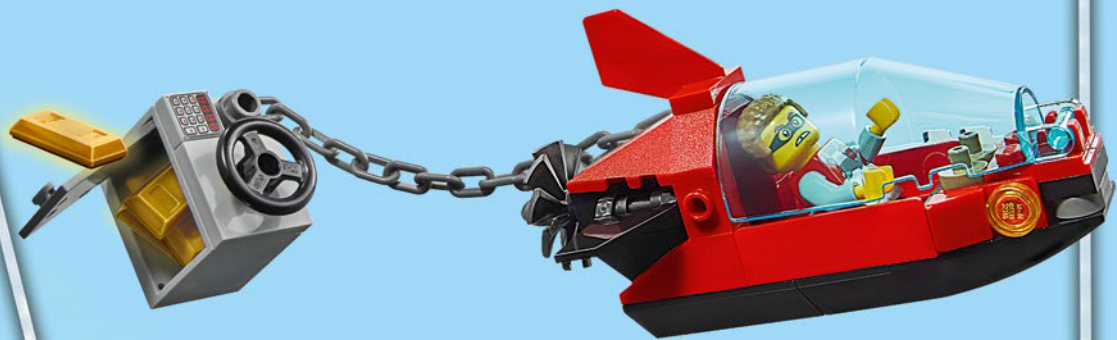



CITY ADVENTURES

AVENTURAS CITY



VITO
60242



SAM
GRIZZLED
60243



SNAKE
RATTLER
60243 • 60276



ROOKY
PARTNER
60244



FRANKIE
LUPELLI
60244 • 60277



TOM
BENNETT
60245



BIG
BETTY
60245



WHEELER
60246



DAISY
KABOOM
60246



CLARA
THE CRIMINAL
60276



GRACIE
GOODHART
60277



DUKE
DETAIN
60242 • 60246 • 60276



FREYA
MCLOUD
60248 • 60280



CLEMMONS
60247 • 60281



BOB
60282



FELDMAN
60282



TREAD
OCTANE
60258



HARL
HUBBS
60258 • 60266



SHIRLEY
KEEPER
60292



MADISON
60292

CITY
ADVENTURES

AVENTURAS
CITY



FROM THE HIT
TV SERIES!

DE LA SÉRIE TÉLÉ
À SUCCÈS !

¡DE LA POPULAR
SÉRIE DE LA TELE!





CITY



60277



60275



60276