



CITY

60389



1



 **FR**
DONNEZ
OU
RECYCLEZ

 OU  OU 

ASSOCIATION MAGASIN DÉCHÈTERIE

Adresses sur quefairedemesdechets.fr



LEGO.com/sustainable-packaging



BUILDER



Apple and the Apple logo are trademarks of Apple Inc., registered in the U.S. and other countries and regions. App Store is a service mark of Apple Inc. Google Play and the Google Play logo are trademarks of Google LLC. Tencent and the Tencent logo are trademarks of Tencent Inc.

EN Ask parents' permission before going online | **DE** Eltern um Erlaubnis bitten, bevor du online gehst | **FR** Demande l'autorisation d'un parent avant d'aller en ligne | **IT** Chiedi il permesso ai tuoi genitori prima di andare online | **ES** Pídeles permiso a tus papás antes de conectarte a Internet | **PT** Pede autorização aos pais antes de acederes online | **JA** オンラインになる前に ほかの方のきよかをもらおう | **ZH** 上网前应先征得父母的同意 | **KO** 온라인 접속 전에 보호자 동의가 필요합니다 | **RU** Спроси разрешения у родителей, прежде чем заходить в интернет | **PL** Poproś rodziców o zgodę, zanim wejdziesz do Internetu | **CS** Než půjdeš na internet, požádej rodiče o svolení | **SK** Skôr než pôjdeš na internet, vypýtaj si povolenie od rodičov | **HU** Kérj szülői engedélyt, mielőtt online csatlakoznál! | **RO** Cere permisiunea părinților înainte de a te conecta online | **BG** Поискайте разрешение от родител, преди да влезете онлайн | **LV** Pirms došanās tiešsaistē palūdz atļauju vecākiem | **ET** Enne Interneti kasutamist küsi vanematelt luba | **LT** Prieš prisijungdami prie interneto, atsklauskite tėvų

Q [LEGO.com/devicecheck](https://www.lego.com/devicecheck)

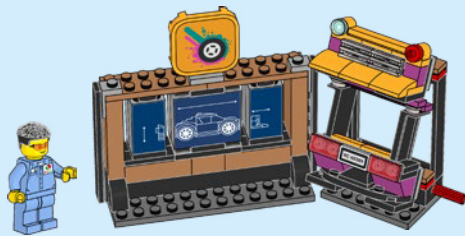
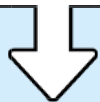
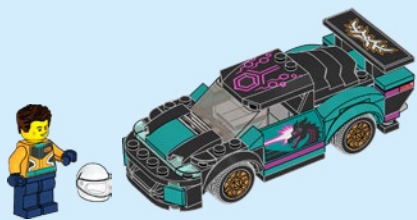
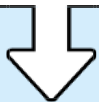



1

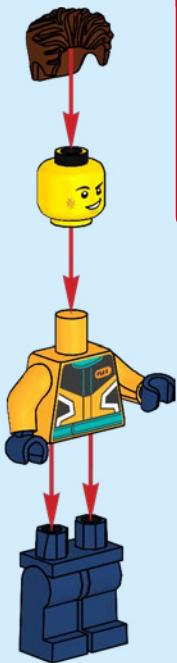

2

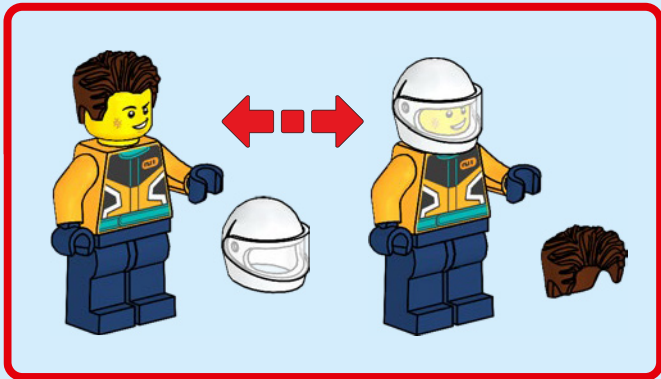
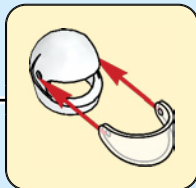

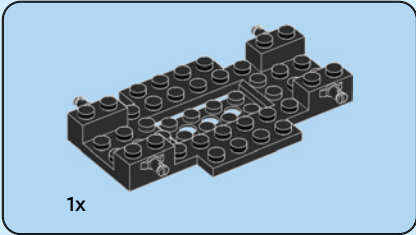
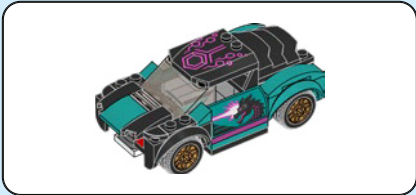

1

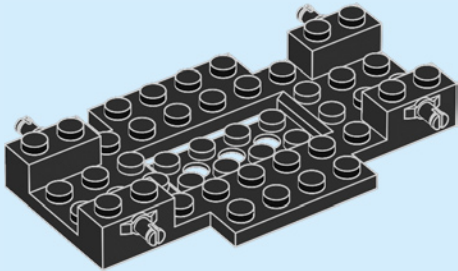

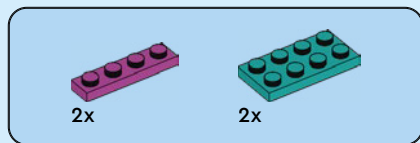

2

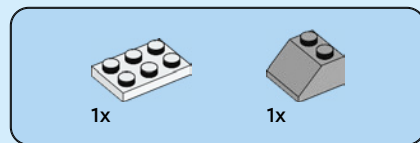
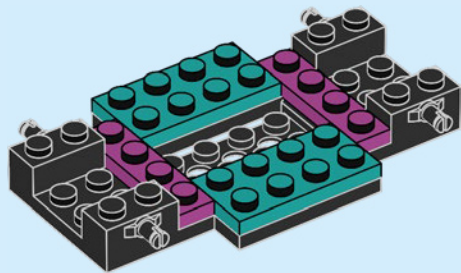

3

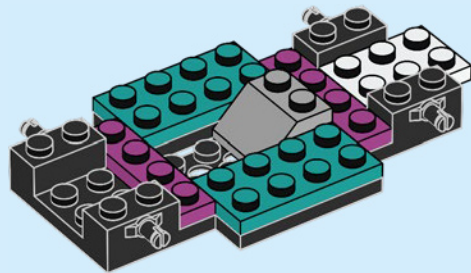

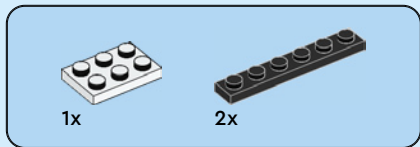

4

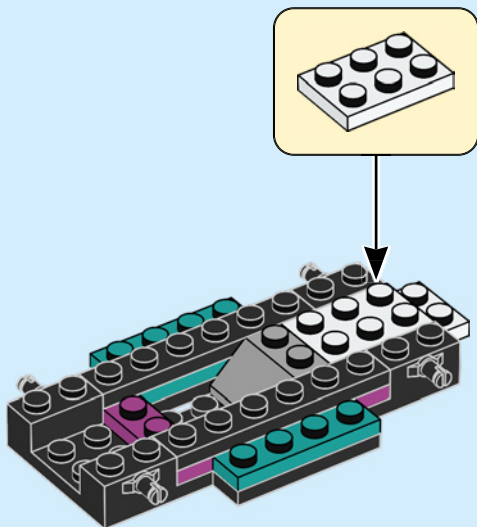



5

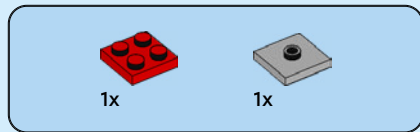
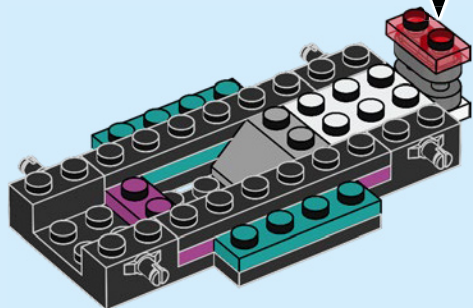
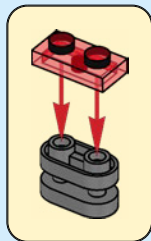

6

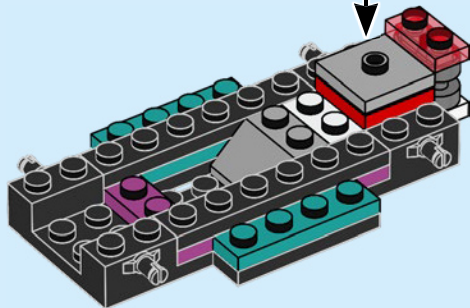
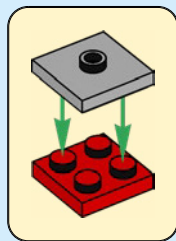

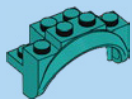

2x

7

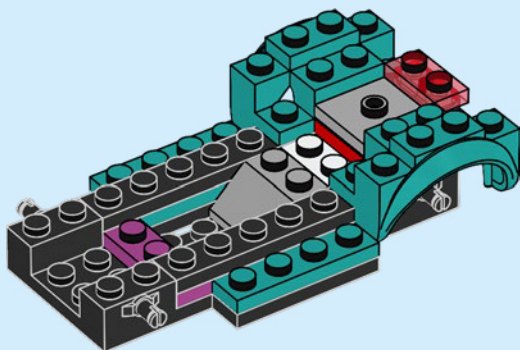



2x

8

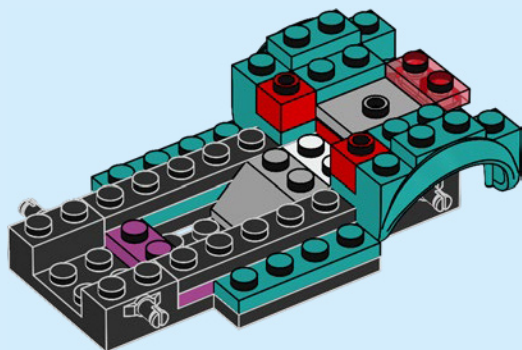

1x



2x

9

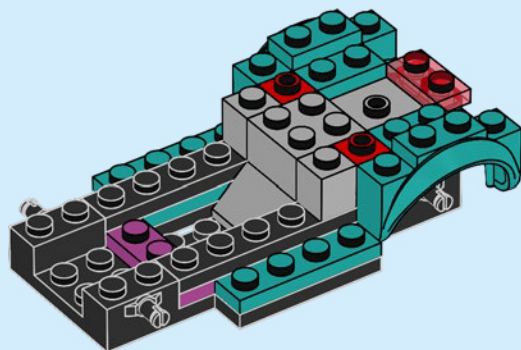

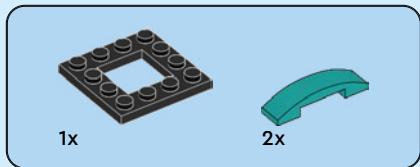

10

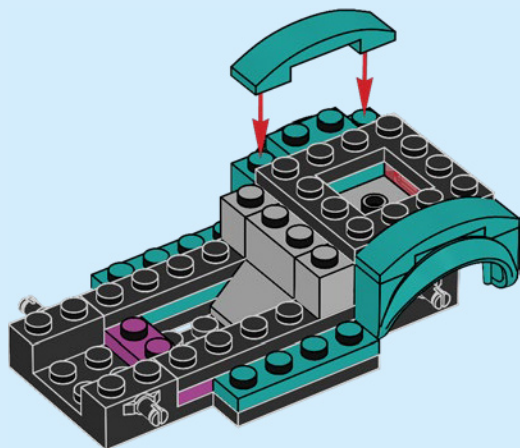



2x

11

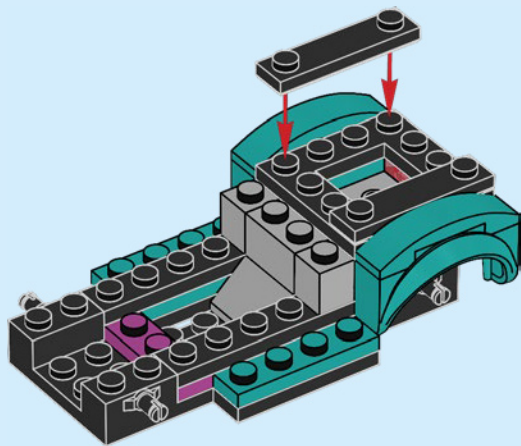

2x

12

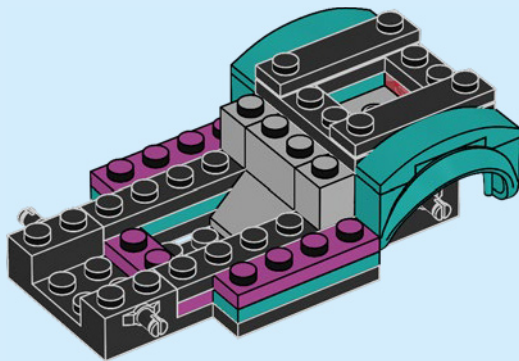



2x

13

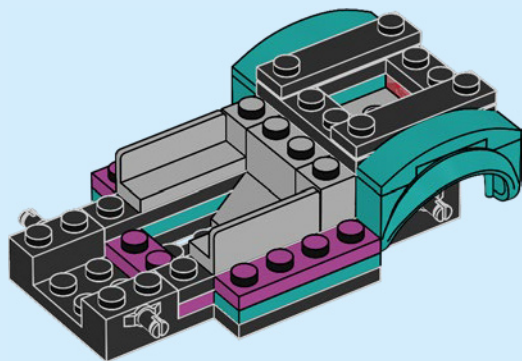

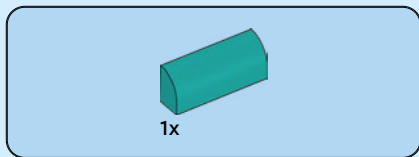

14

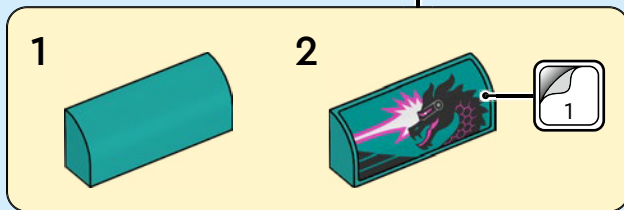
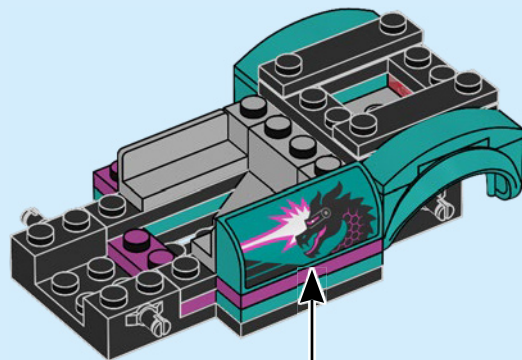

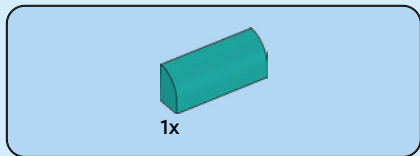

15

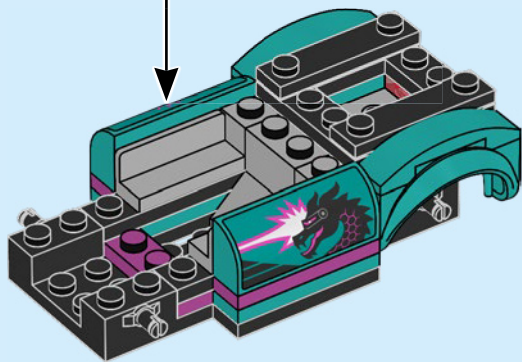



1x

16

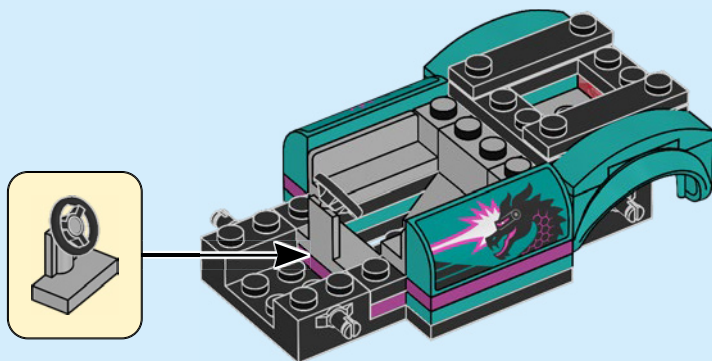

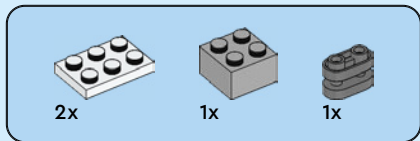

17

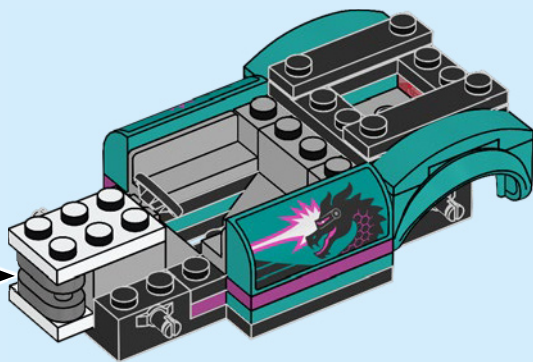
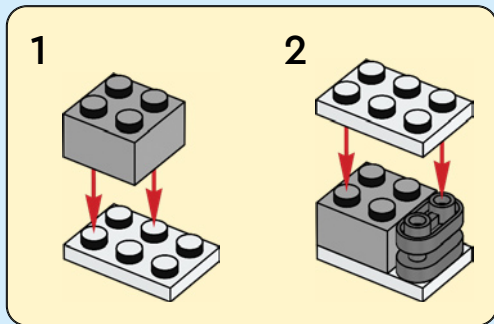



2x

18

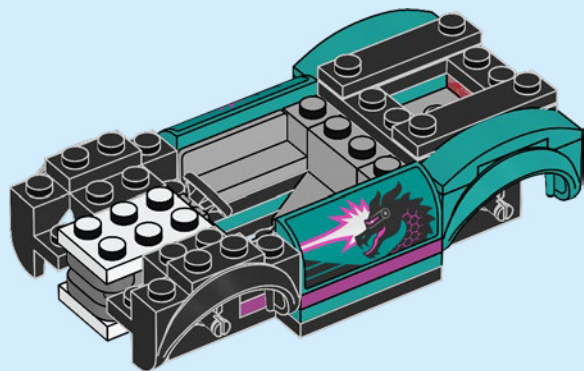

1x



2x

19

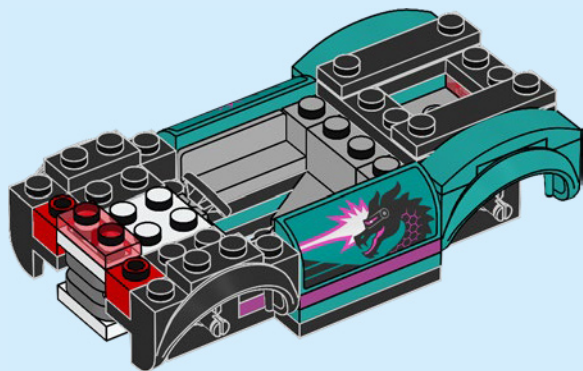



1x

20

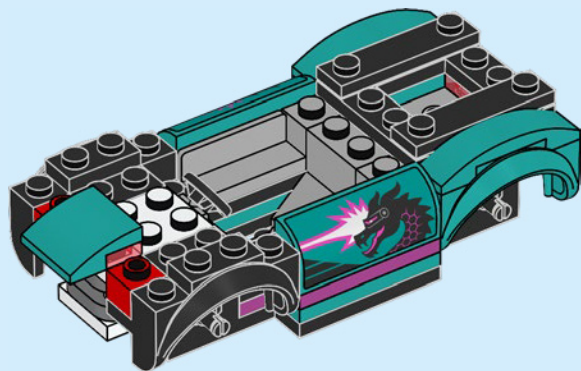

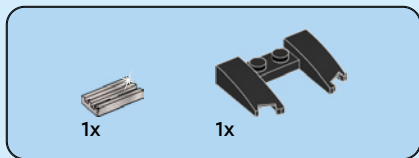

21

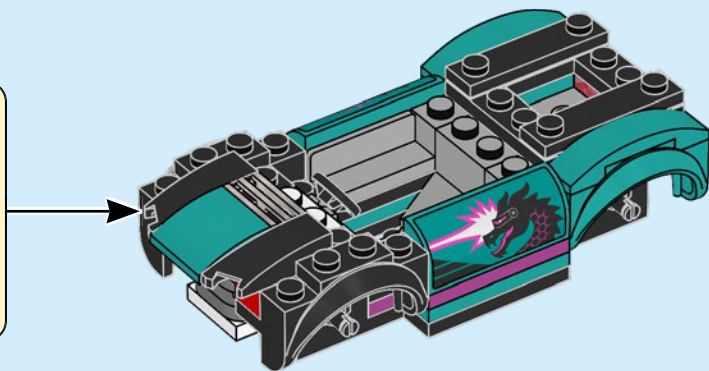
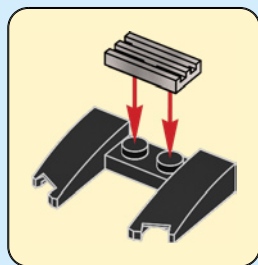



2x

22

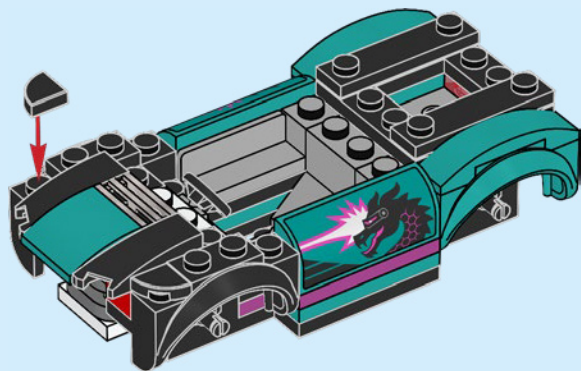

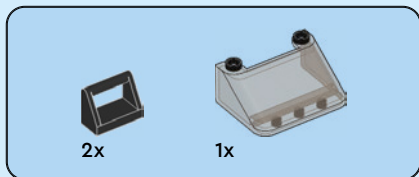

23

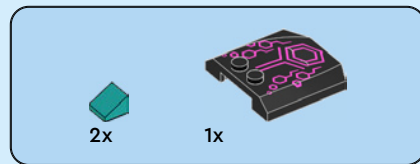
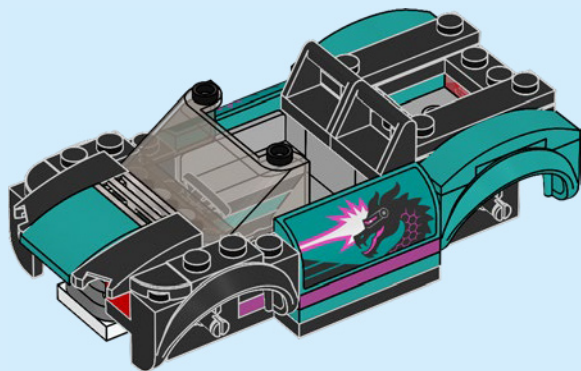

24

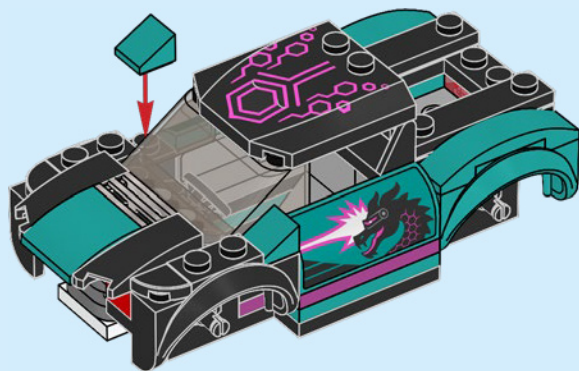

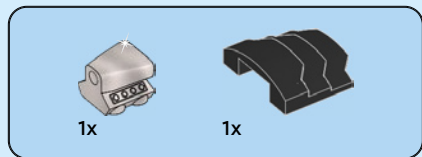

25

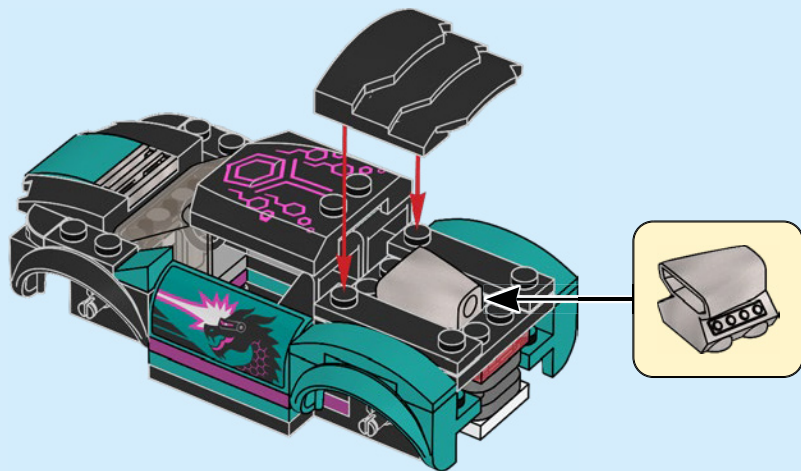

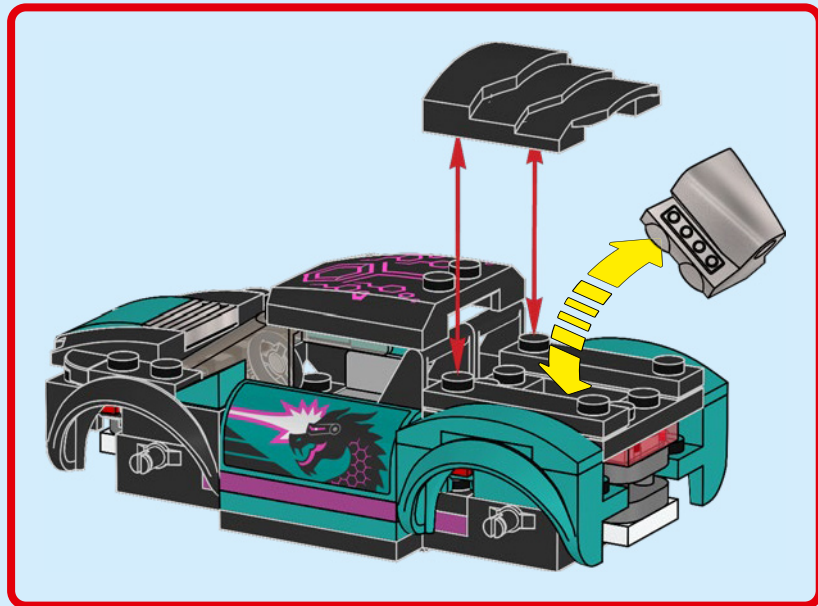



26

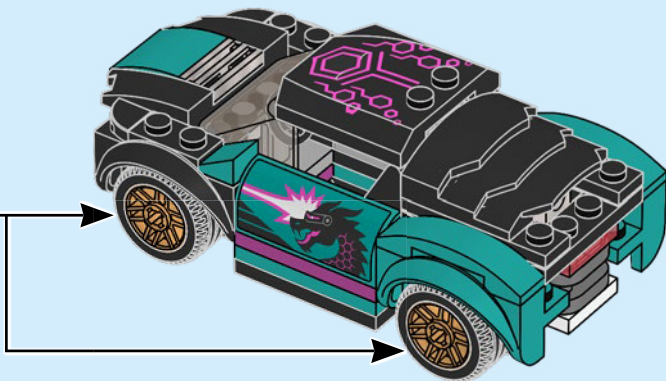
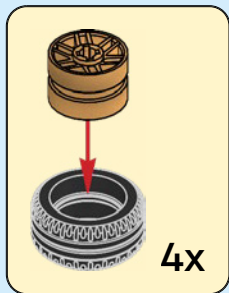

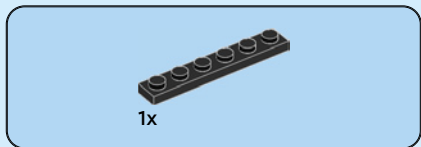

1

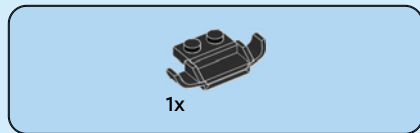
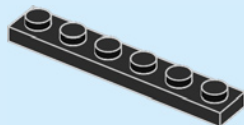

2

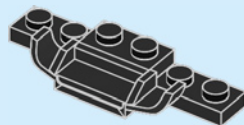



4x

3

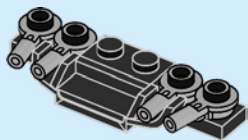

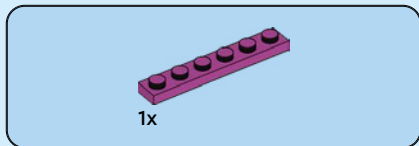

4

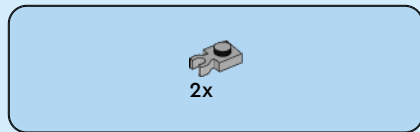
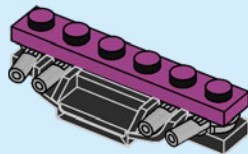

5

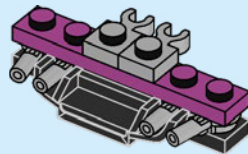



1x

6

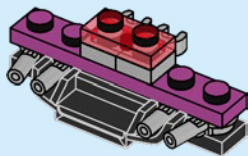



1x



2x

7

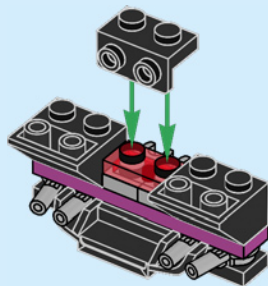

1x

8

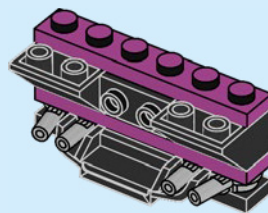



1x

9

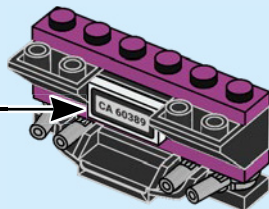
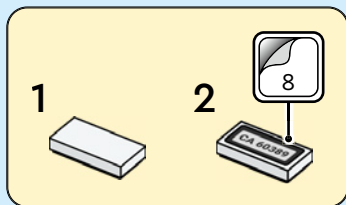



1x



2x

10

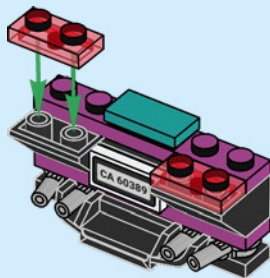

2x



2x

11

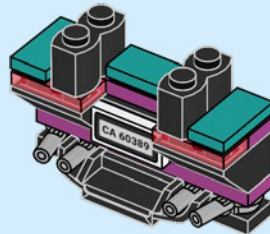

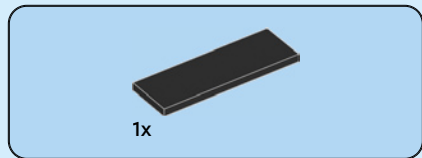

12

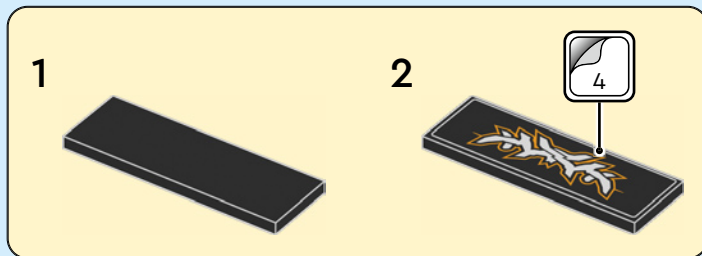



1x

1





1x

2

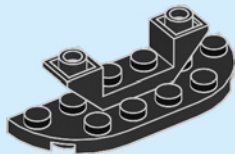

1x

3

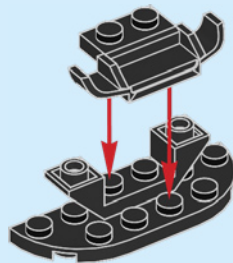



2x

4

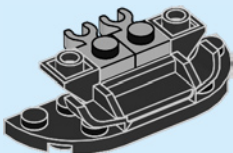



2x

5

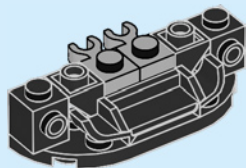

1x

6

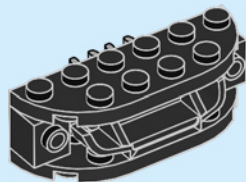



2x

7

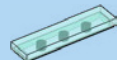
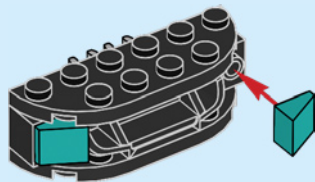

1x



2x

8

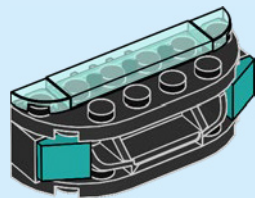

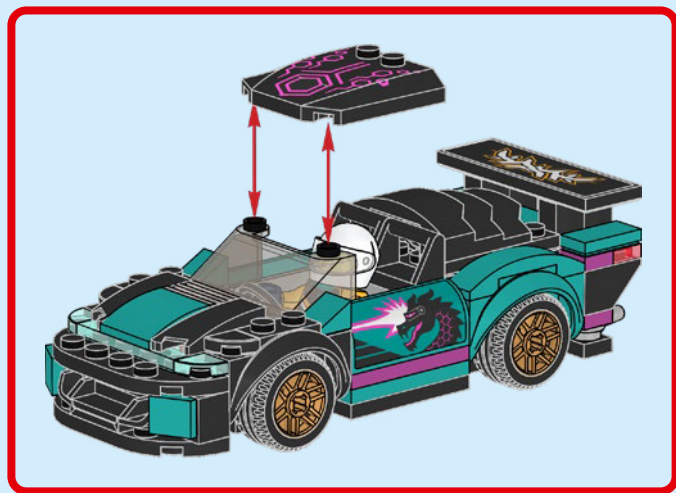

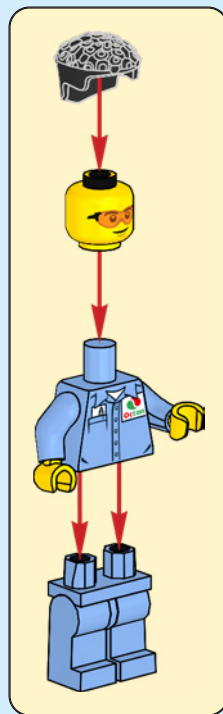



1x

1





1x

2

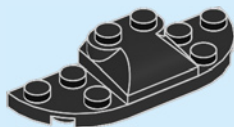

2x

3

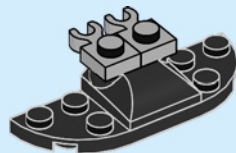



2x

4

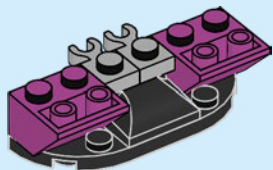

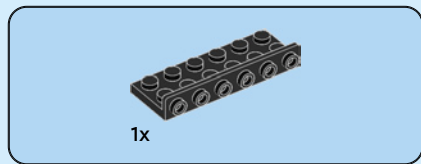

5

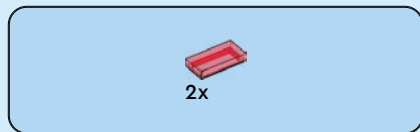
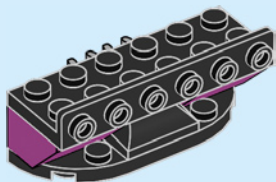

6

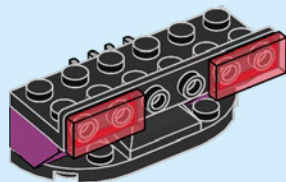



1x

7

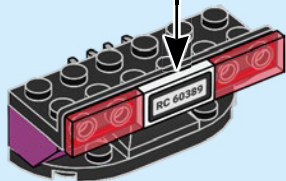
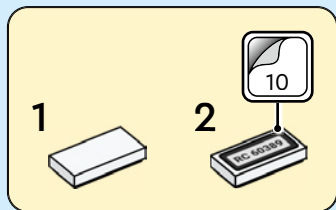

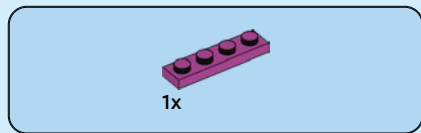

8

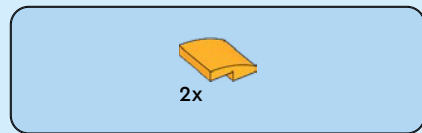
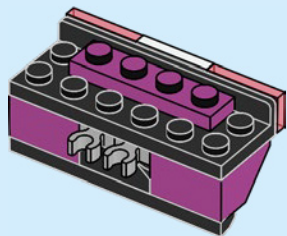
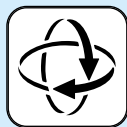

9

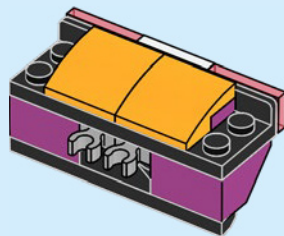



2x

10

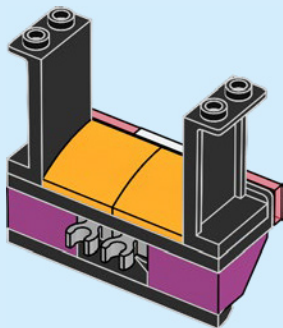

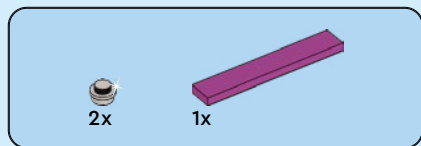

11

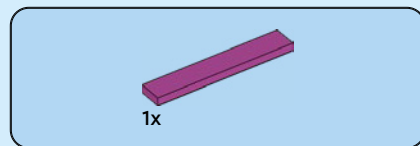
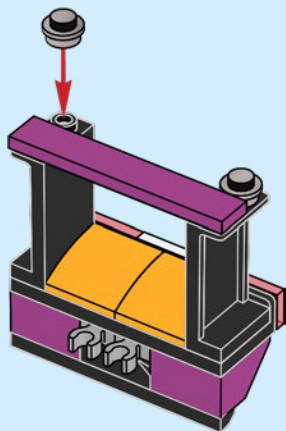

12

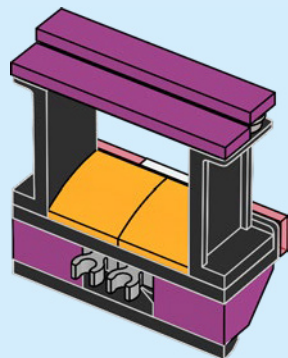

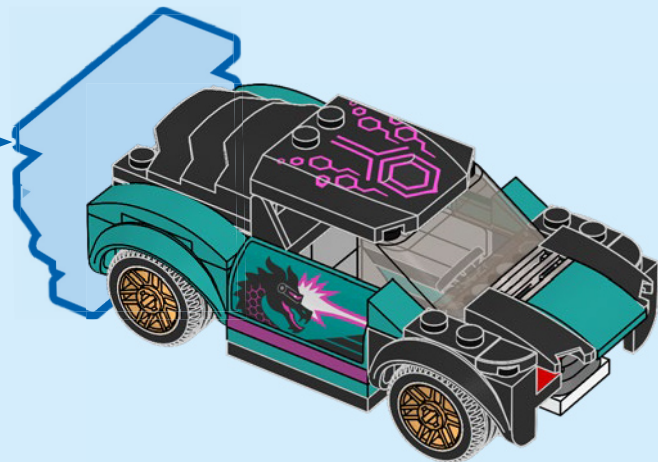
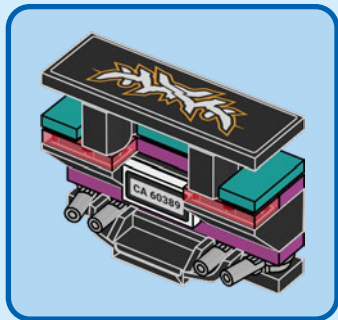
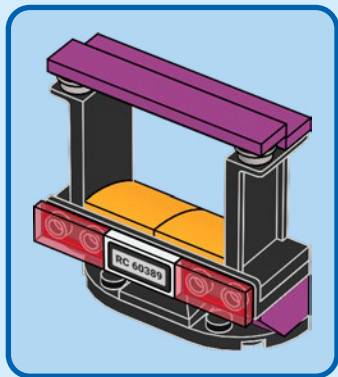

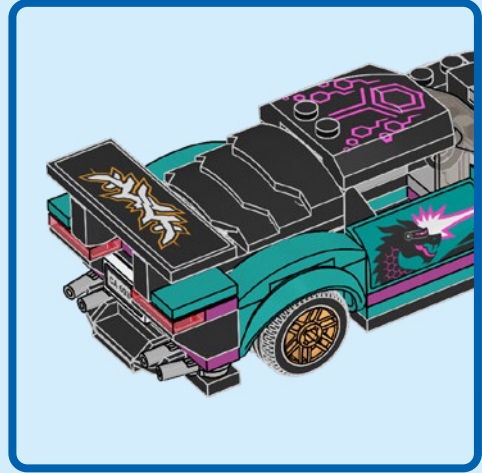
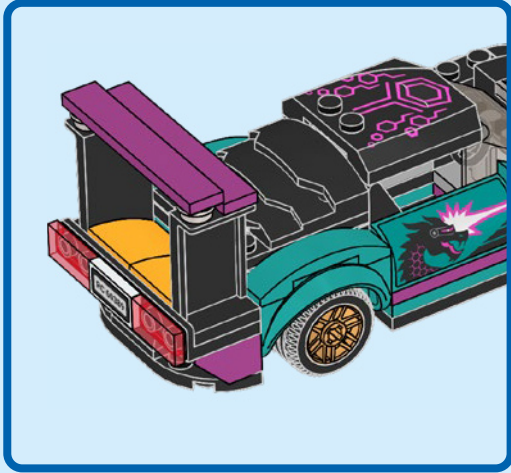

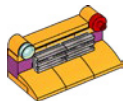

1x



1x

1

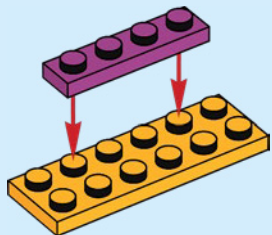



3x

2

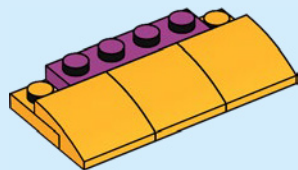

2x

3

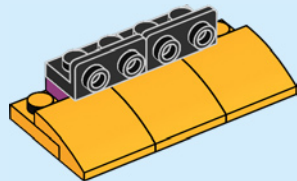



2x



2x

4

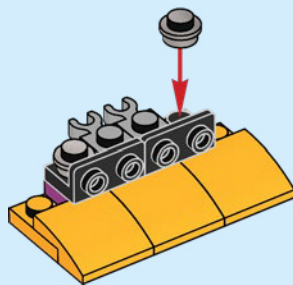



2x

5

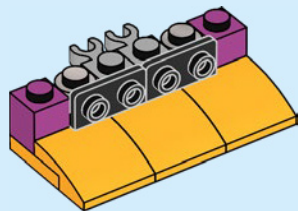

1x



2x

6

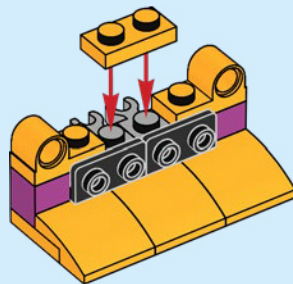

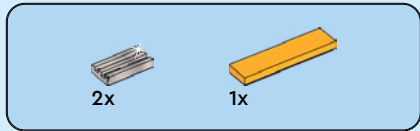

7

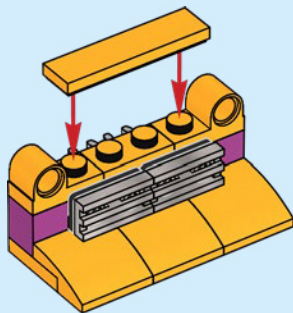



2x

8

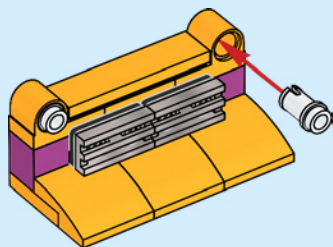

1x



1x

9

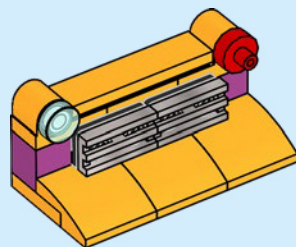

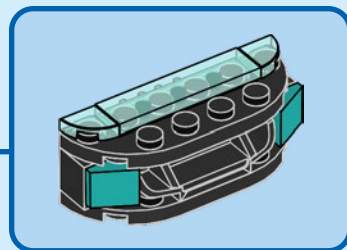
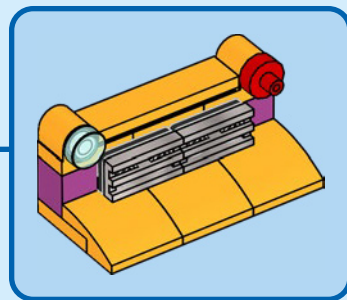
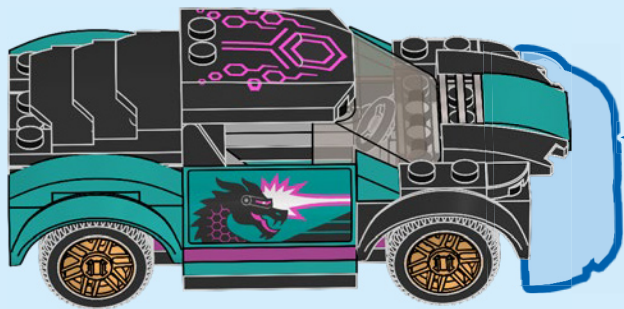

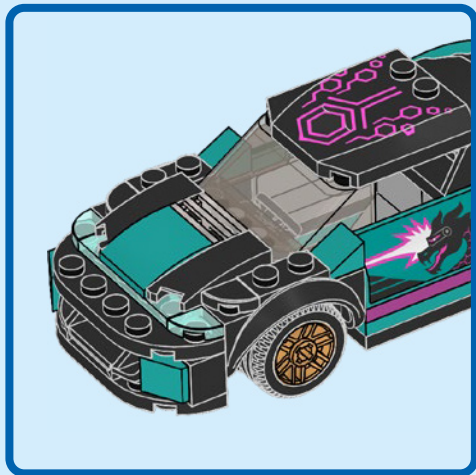
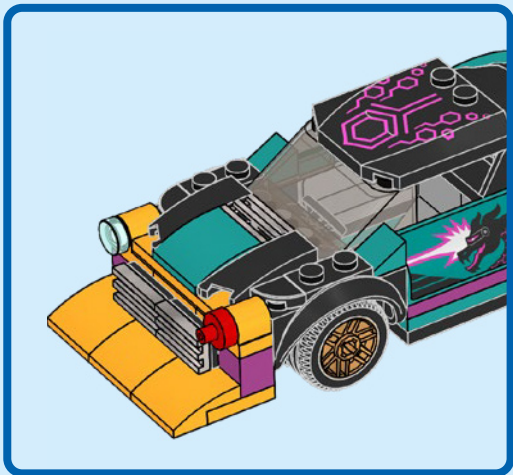

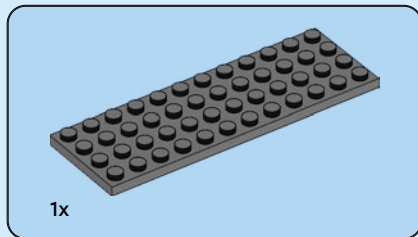
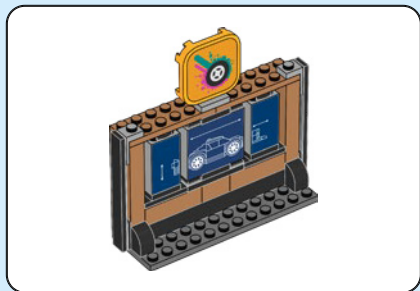

1

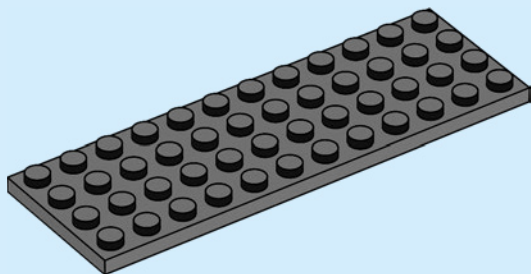

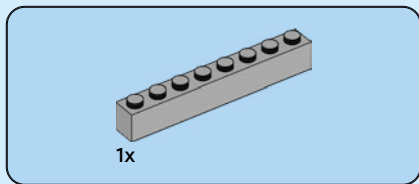

2

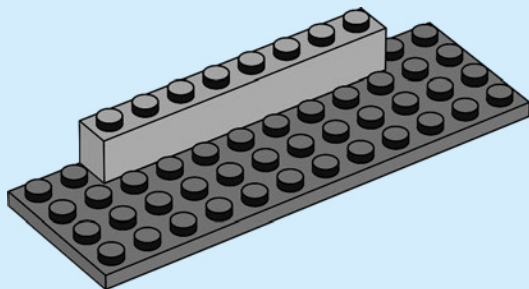

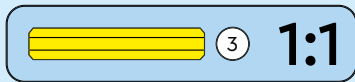
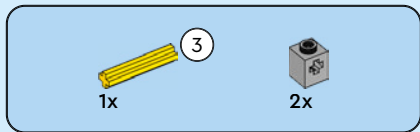

3

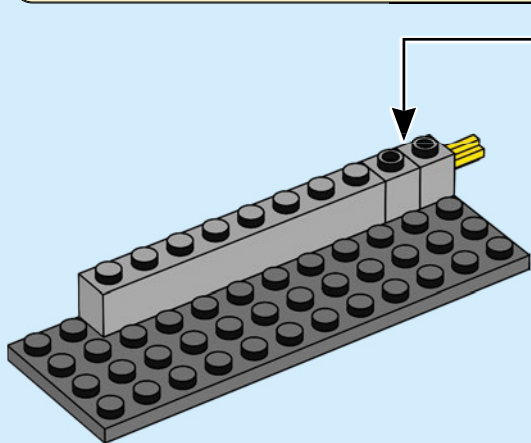
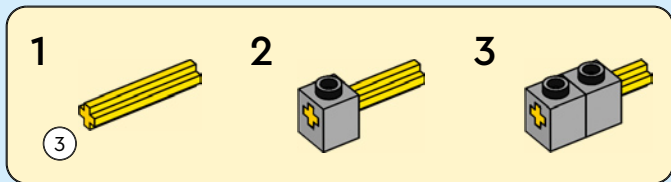



2x

4

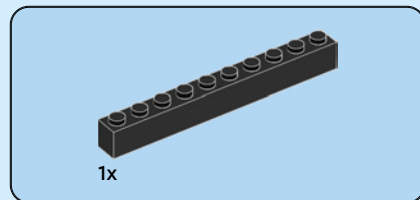
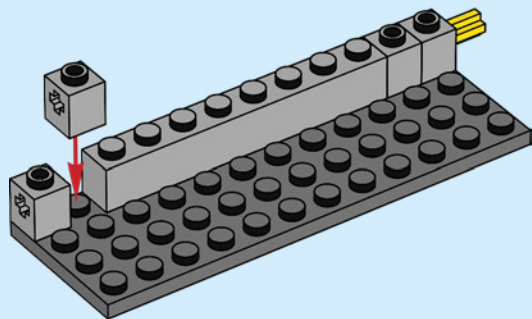

1x

5

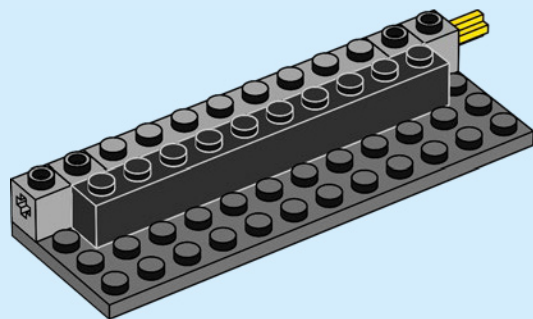

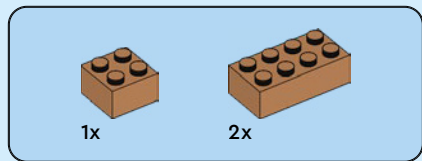

6

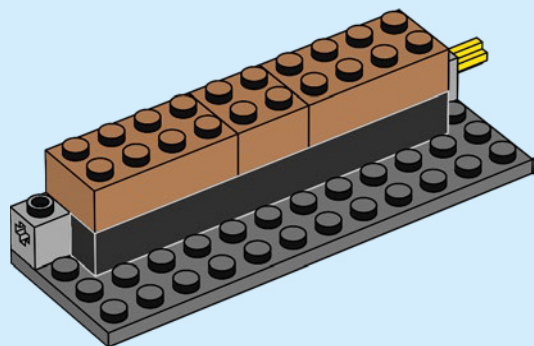

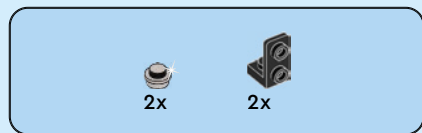

7

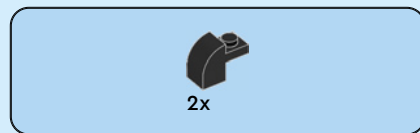
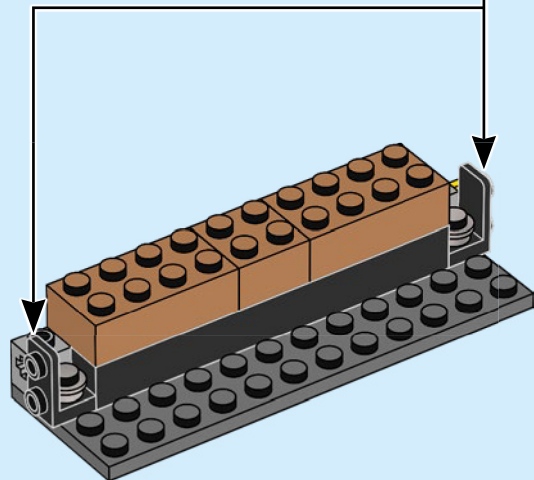
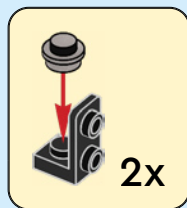

8

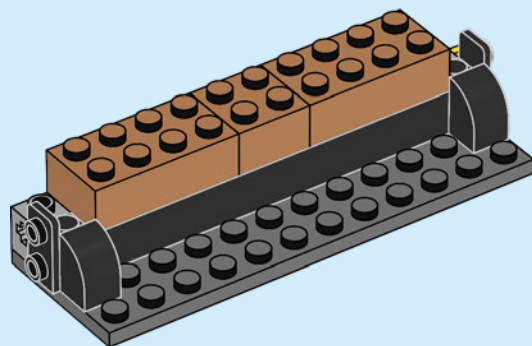

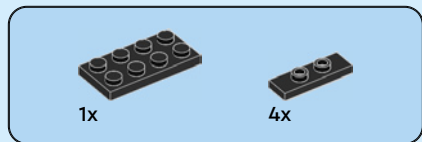

9

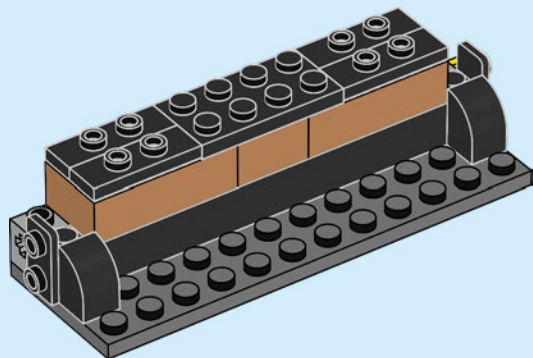



10

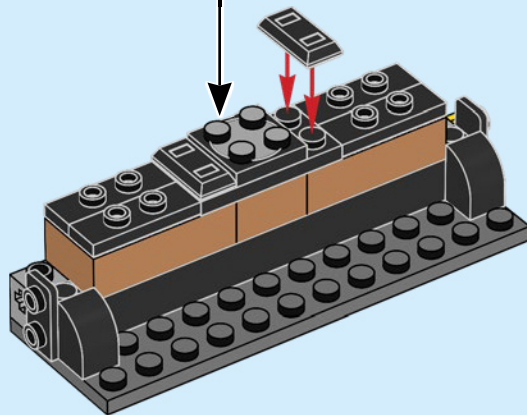
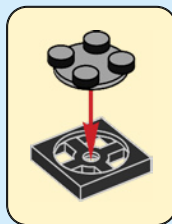

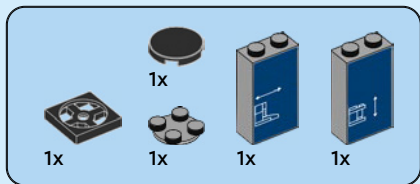

11

1



2



3

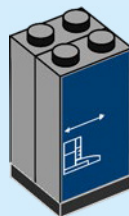

4

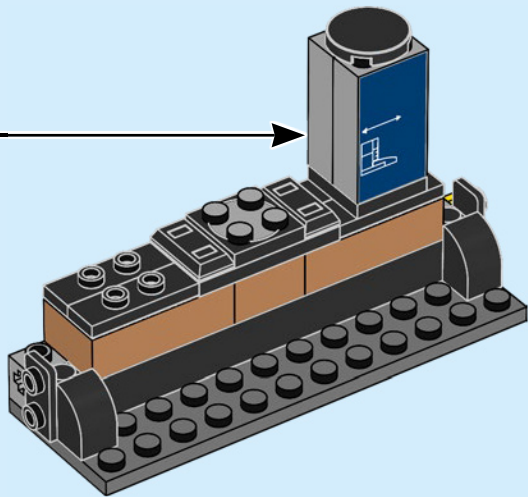
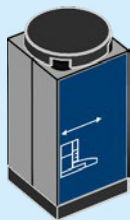

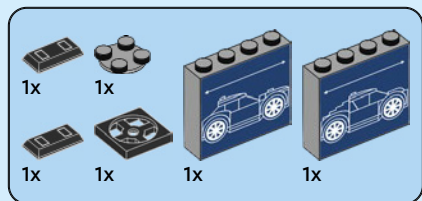

12



1

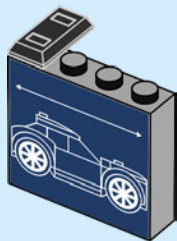

2

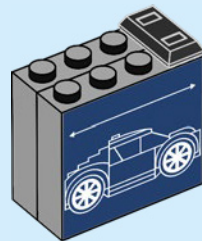

3

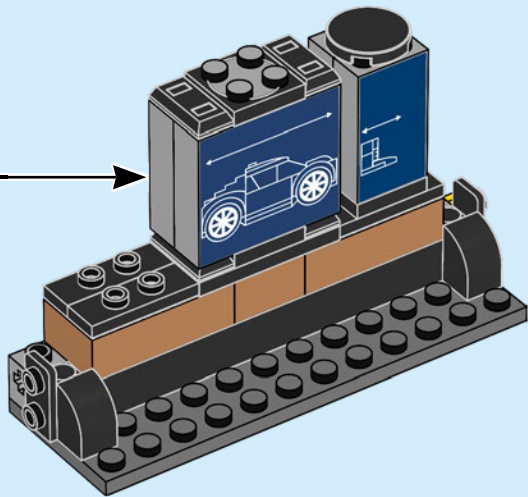
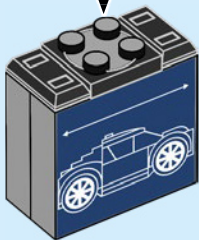
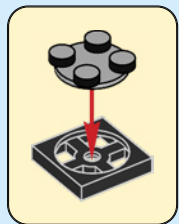

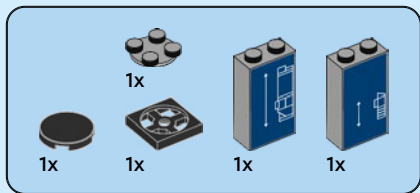

13

1



2

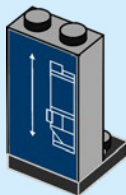

3

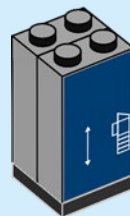
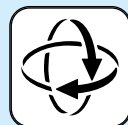

4

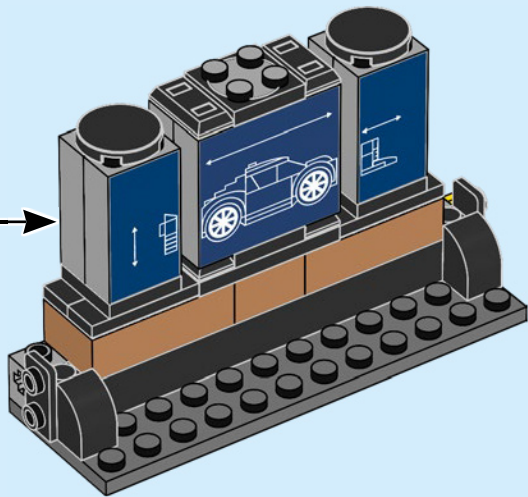
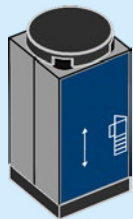

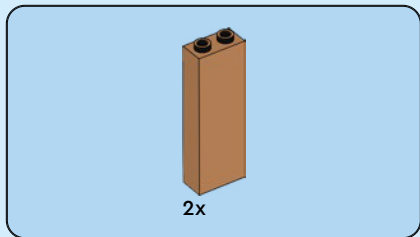

14

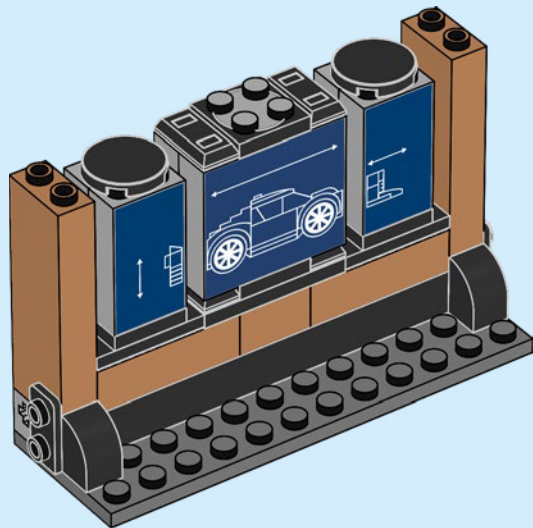

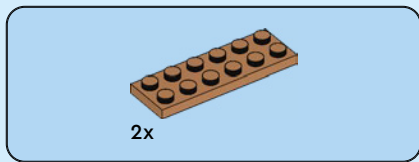

15

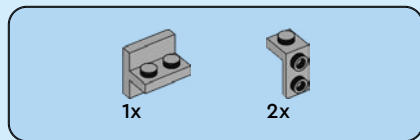
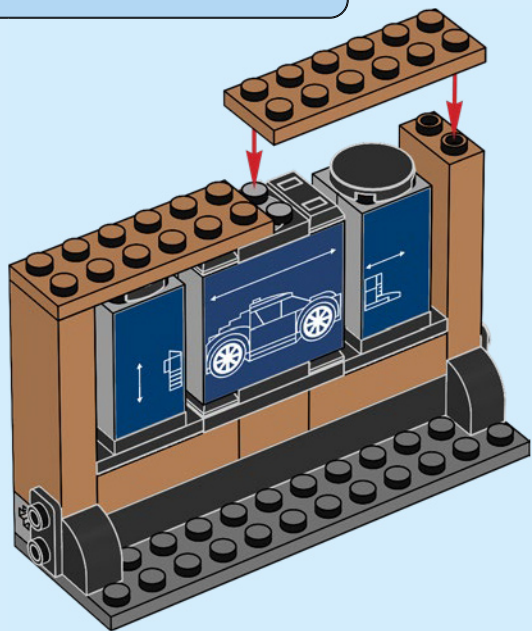

16

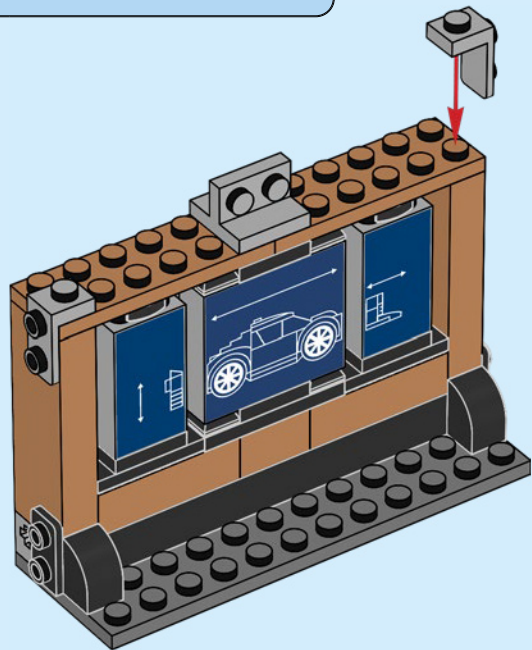

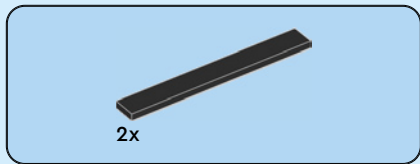

17

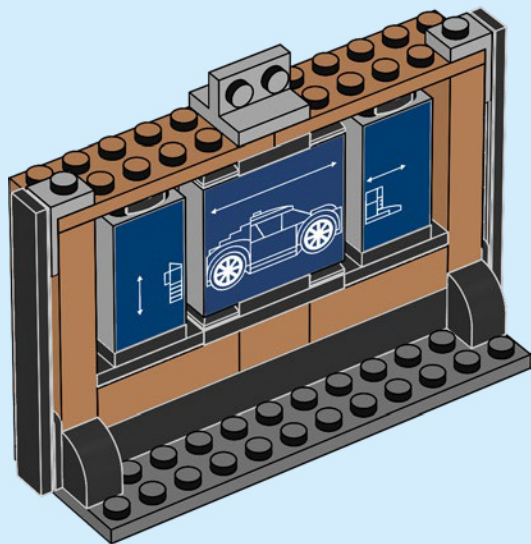

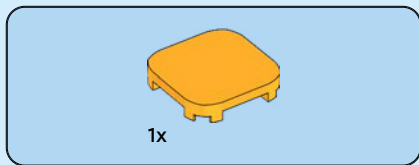

18

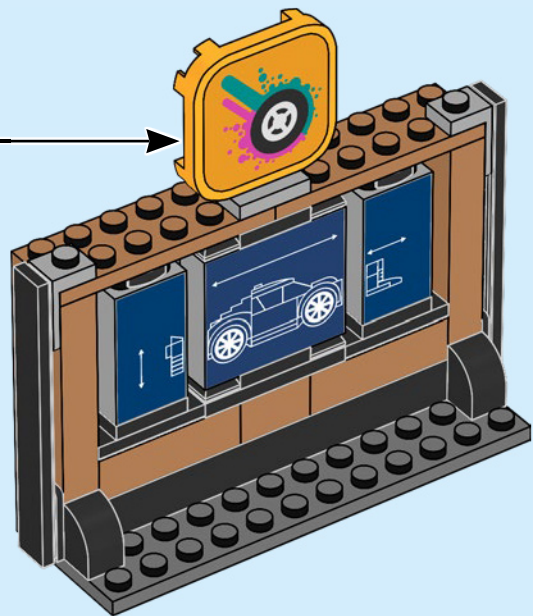
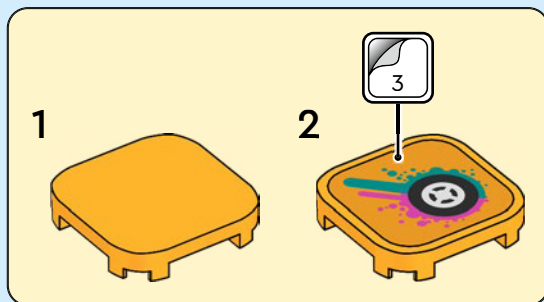

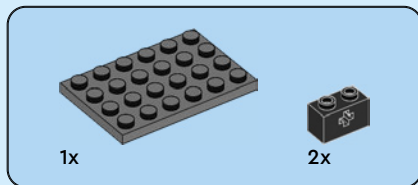
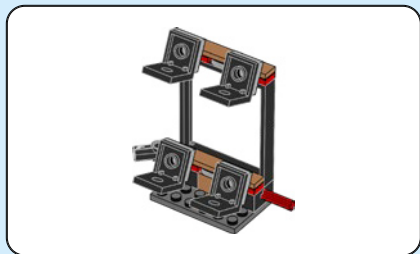

19

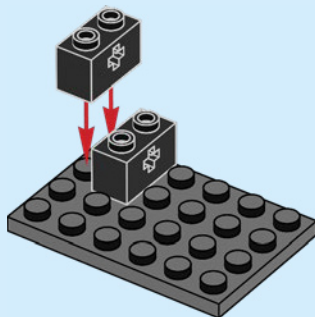

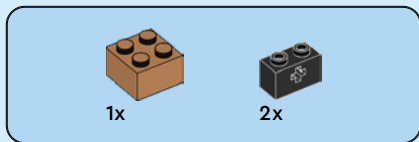

20

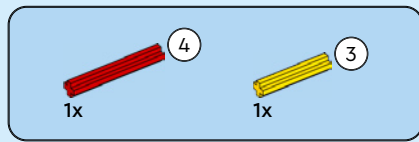
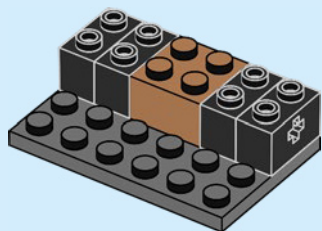

21

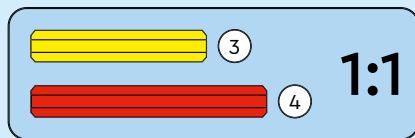
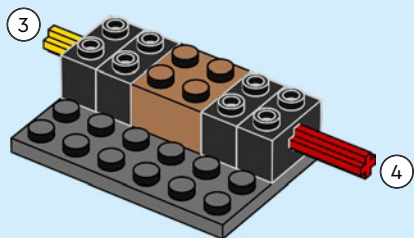



1x

22

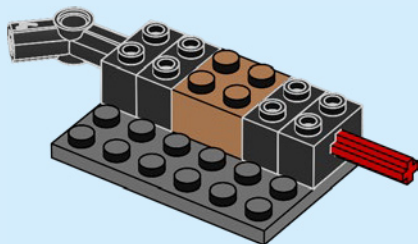



1x



2x

23

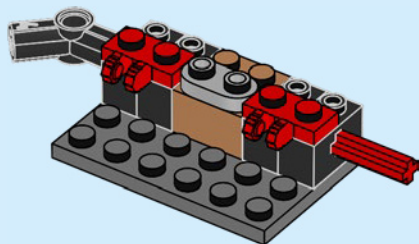

1x

24

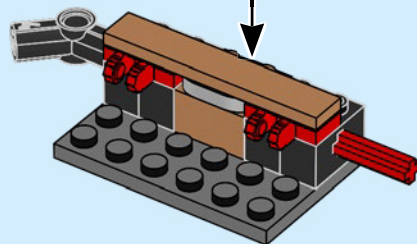
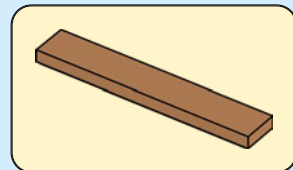

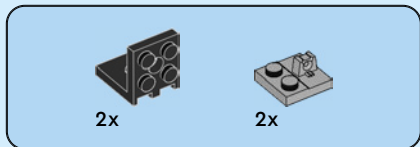

25

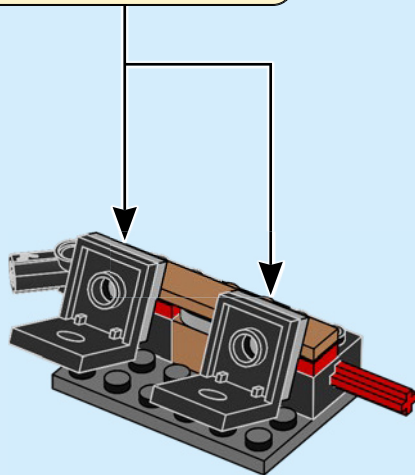
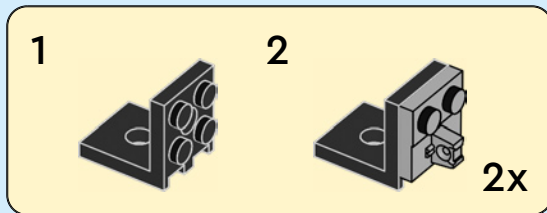

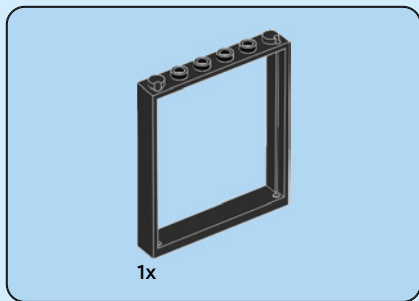

26

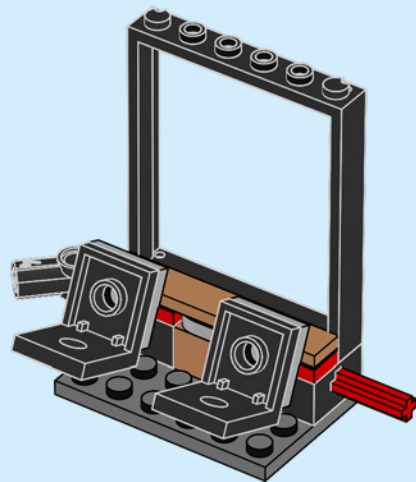



1x



2x

27

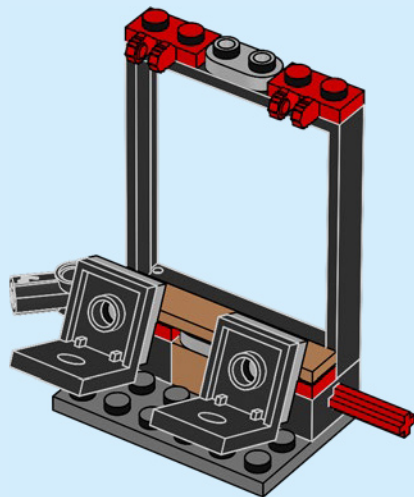

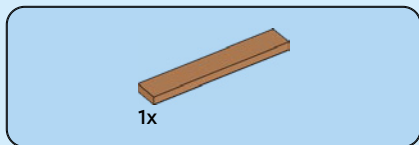

28

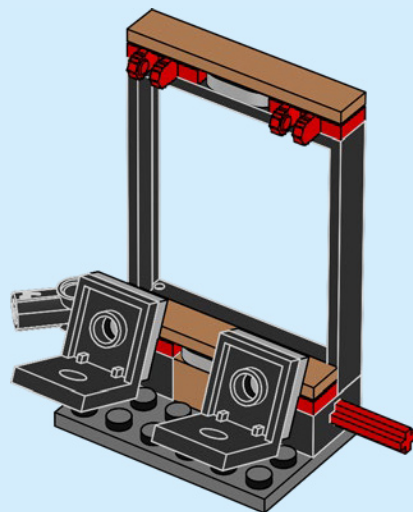

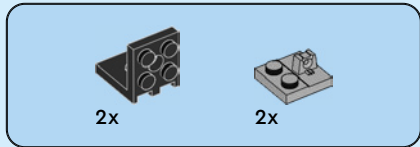

29

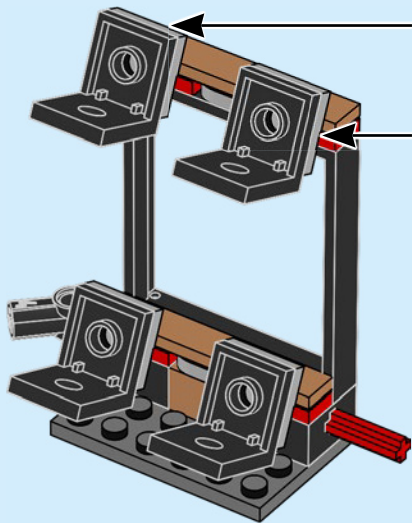
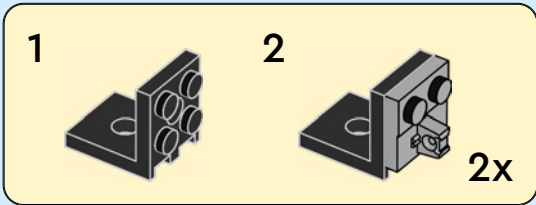

30

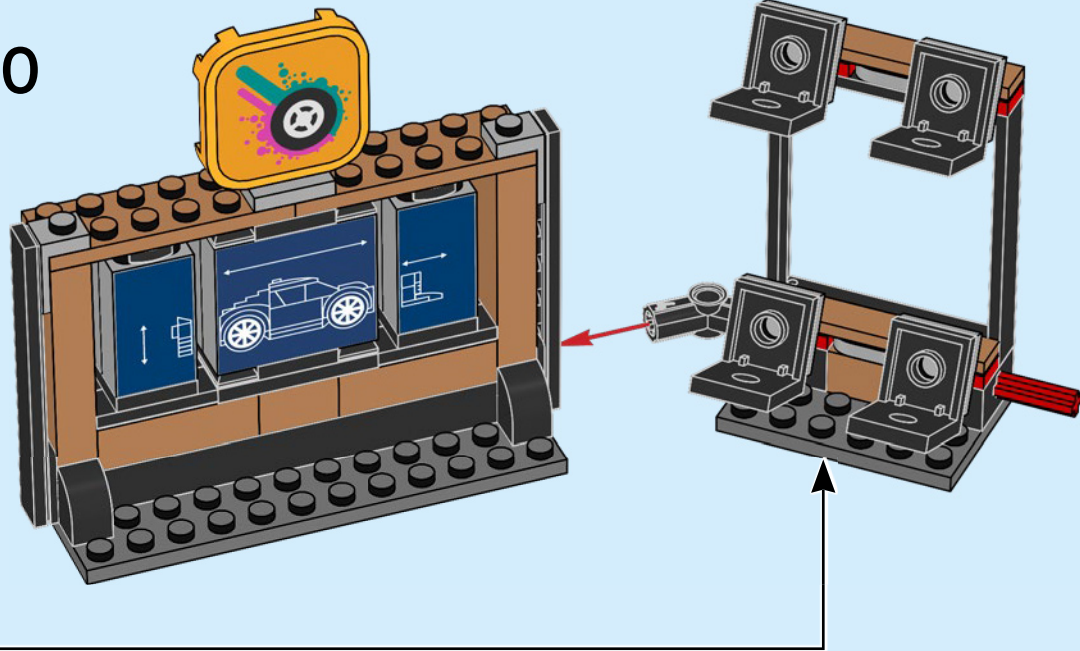



CITY



60387



60389



60383



60385

| | | | | | | | |
|---|---|--|--|--|--|--|--|
|  1x 6325955 |  2x 6338181 |  4x 4654105 |  6x 6092035 |  2x 6244787 |  1x 4298617 |  4x 6130007 |  2x 6186400 |
|  4x 6278172 |  2x 6336510 |  2x 6102821 |  1x 6024286 |  1x 6274739 |  1x 4651524 |  3x 6266283 | |
|  3x 6228967 |  1x 6172869 |  2x 6421680 |  1x 6028736 |  6x 6396287 |  8x 6266205 |  1x 6400771 |  3x 6058085 |
|  3x 6213779 |  2x 6022035 |  2x 6316439 |  2x 6310196 |  1x 6252049 |  4x 6053011 | |  5x 6135191 |
|  2x 6249418 |  1x 6177349 |  2x 6316439 |  5x 6099730 |  3x 6247359 |  1x 393721 |  1x 6176636 |  4x 6102995 |
|  1x 6223665 |  1x 6430396 |  1x 6097509 |  2x 6023173 |  2x 6129995 |  1x 6029946 |  1x 6223923 |  2x 6313600 |
|  1x 6310580 |  1x 6419156 |  3x 6072668 |  4x 6214457 |  1x 302021 |  2x 302221 |  1x 6283884 |  4x 6360035 |
|  2x 6249299 |  2x 6172860 |  2x 6422296 |  4x 6258607 |  4x 4560179 |  2x 6126048 |  1x 6329589 | |
|  2x 6217667 |  14x 6037652 |  2x 6097511 |  2x 6251290 |  2x 6335578 |  1x 4619543 |  1x 6079007 |  1x 6226644 |

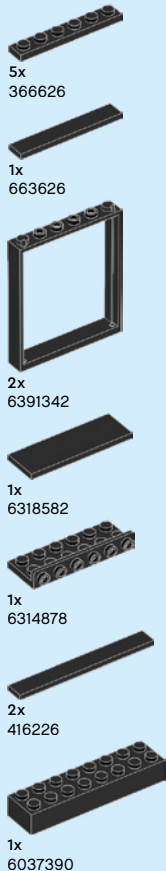
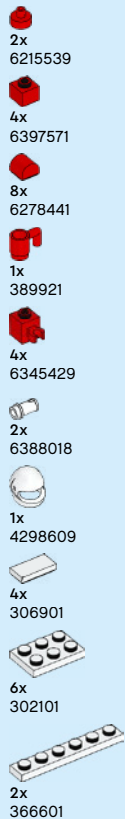

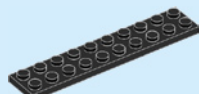

2x
383226

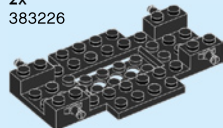

2x
6285534



1x
611126

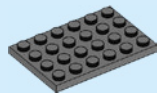

2x
4211115



1x
4211061

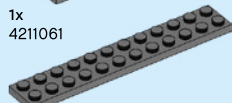

2x
4211067

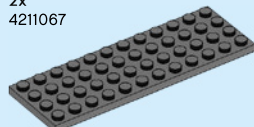

1x
4210706



1x
4529240



1x
6263570



5x
6390673



1x
6116470



2x
6352600



1x
6338470

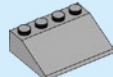

1x
4211420

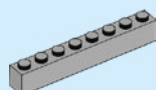

2x
4211392



4x
6227897



16x
6296894



2x
6152344



4x
4540203



2x
4211807



4x
4211383



2x
6168633



1x
6326078



2x
4211469



1x
6422508



1x
6419133



1x
6419134



1x
6419121



1x
6132390



2x
6258820



2x
4211387



1x
4211410



4x
6126082



9x
6265742



1x
6338962



4x
6210581



1x
4217918



1x
4211394



1x
6419141



1x
6419142



4x
6258831



2x
4211389



4x
6336539



2x
6362975



7x
6248890



4x
6419140



1x
6430408



1x
4162916



4x
6268401



15x
4633691



3x
4619636



2x
6076604



1x
6103444



2x
6047056



1x
6267919



1x
4653267



1x
6267760



 [LEGO.com/service](https://www.lego.com/service)

YOU COULD **WIN**



Scan this QR code or go to **LEGO.COM/PRODUCTFEEDBACK** and give us your short feedback about this LEGO® set for a chance to win a cool LEGO prize.

Terms and Conditions apply*

DE: Du könntest GEWINNEN. Es gelten die Teilnahmebedingungen* **FR: Tu pourrais GAGNER.** Des conditions s'appliquent* **IT: Potresti VINCERE tu.** Termini e condizioni sono applicabili* **ES: Puedes GANAR.** Aplican términos y condiciones* **PT: Poderá GANHAR.** Aplicam-se termos e condições* **JA: プレゼント付き! 利用規約が適用されます*** **ZH: 轻松获奖. 条款和条件适用*** **KO: 상품의 주인이 되어보세요. 소정의 약관이 적용됩니다*** **RU: Вы можете ВЫИГРАТЬ.** Действуют положения и условия* **PL: Szansa na WYGRANĄ.** Obowiązują warunki korzystania* **CS: Máte šanci VYHRÁT.** Platí všeobecné smluvní podmínky* **SK: Máte šancu VYHRAŤ.** Platia všeobecné zmluvné podmienky* **HU: TE IS NYERHETSZ.** Felhasználási feltételek érvényesek* **RO: Ai putea CÂȘTIGA.** Se aplică termenii și condiții* **BG: Можете да СПЕЧЕЛИТЕ.** Има определени правила и условия* **LV: Tu vari LAIMĒT.** Ir spēkā noteikumi un nosacījumi.* **ET: Sul on võimalus VÕITA.** Kehtivad tingimused* **LT: Jūs galite LAIMĖTI.** Taikomos sąlygos*

*LEGO.com/productfeedback-terms