

The LEGO logo is positioned in the top left corner of the page. It consists of the word "LEGO" in white, bold, sans-serif capital letters, set against a red rectangular background.

HERO FACTORY



6227



WARNING: CHOKING HAZARD.
Toy contains small parts and a small ball.
Not for children under 3 years.



HERO FACTORY

+300

GAME POINTS

Use the code - get 300 game points
Utilise le code - obtiens 300 points bonus
Consigue 300 puntos para el juego en la web con este código







1

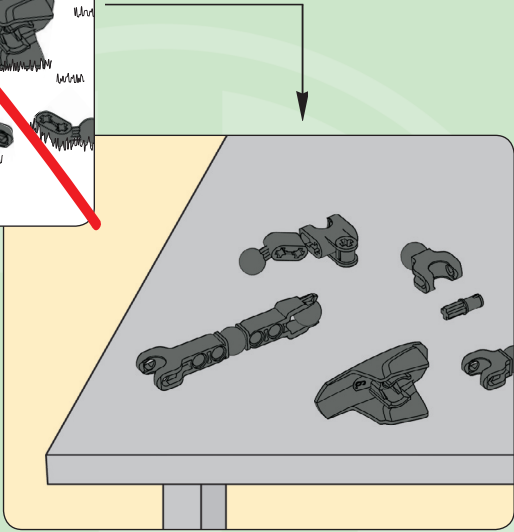
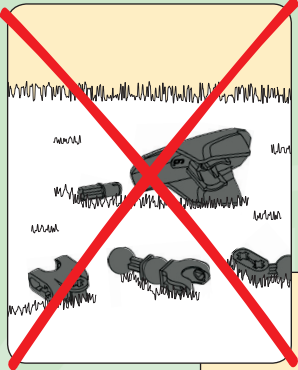

2

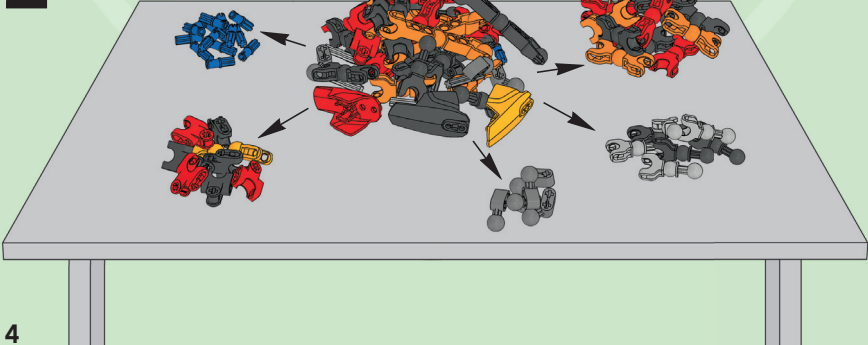

4



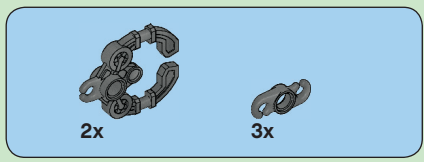

1

AVERTISSEMENT : RISQUE D'ÉTOUFFEMENT.
 Le jouet contient des petites pièces ainsi qu'une petite boule.
 Il ne convient pas aux enfants de moins de 3 ans.

ADVERTENCIA: PELIGRO DE ASFIXIA.
 Juguete que contiene partes pequeñas y una pelota pequeña.
 No recomendado para niños menores de 3 años.



1

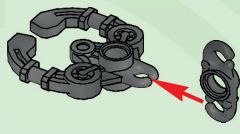

2

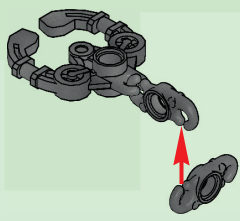

3

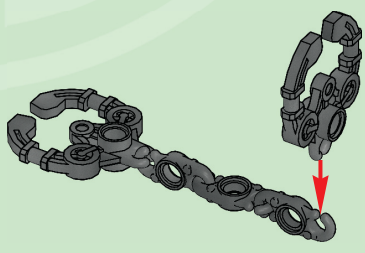

5



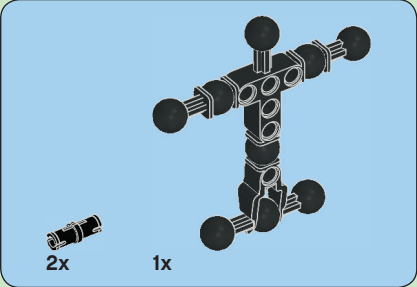

1

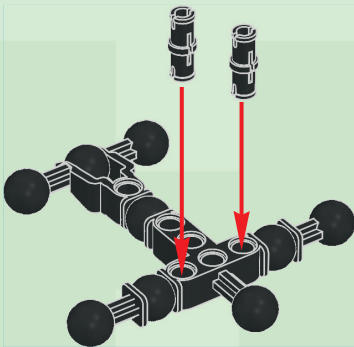

6



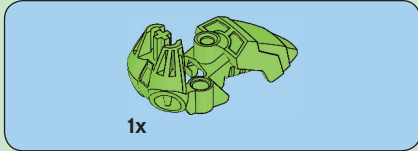

2

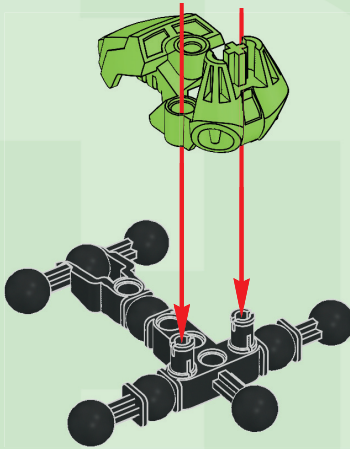

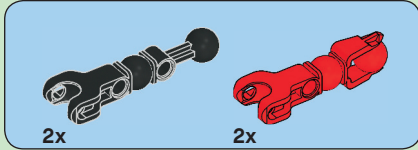

3

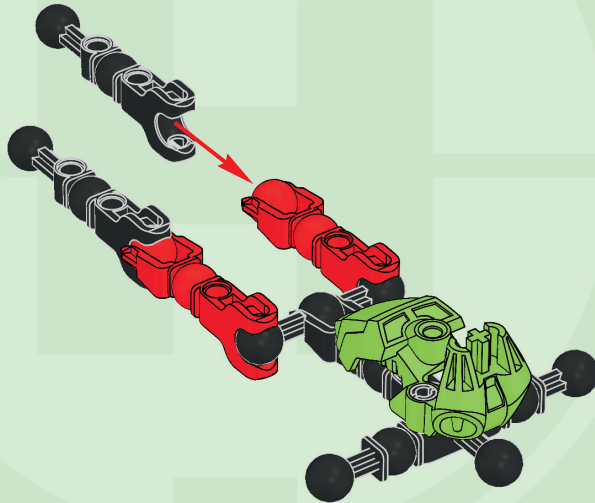

8





4

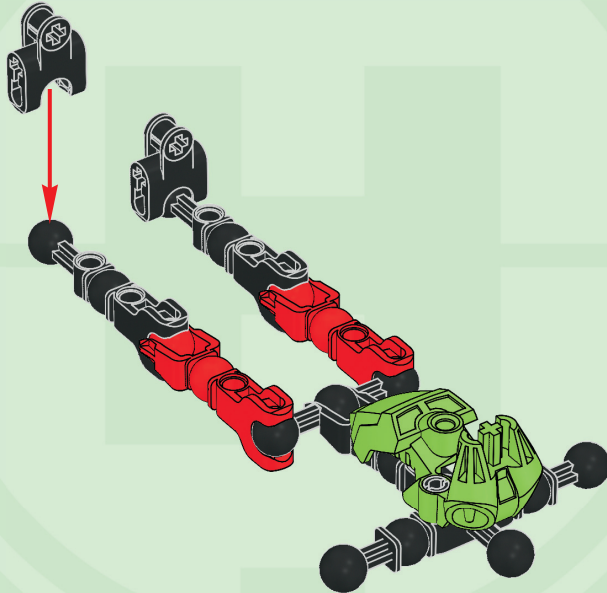

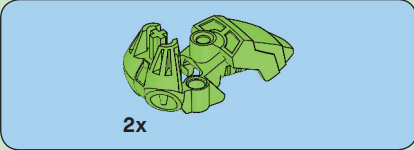

5

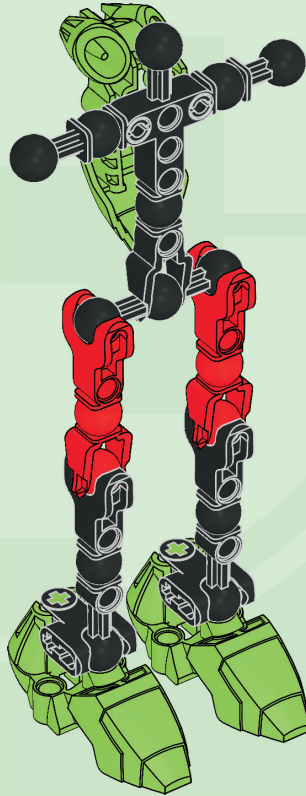
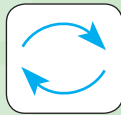

10



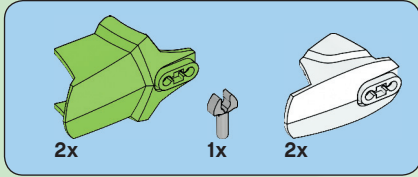

6

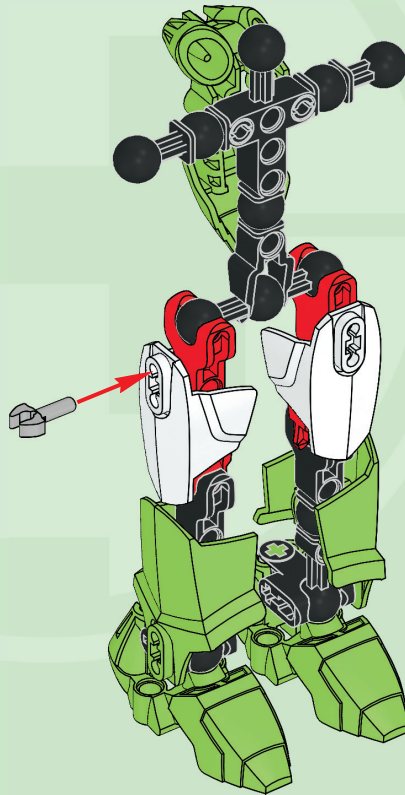



7

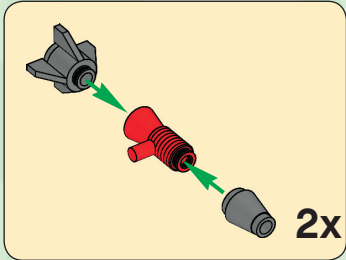
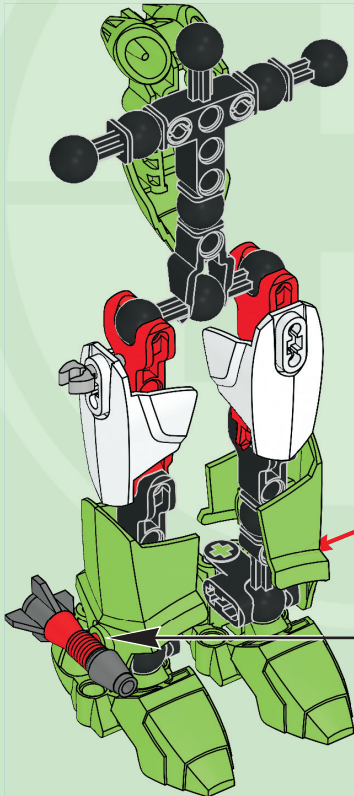

12



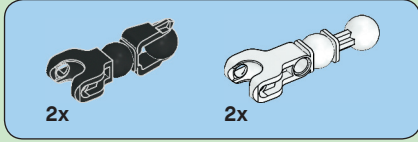

8



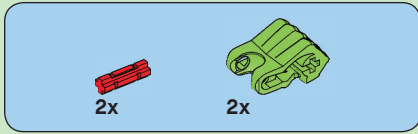

9

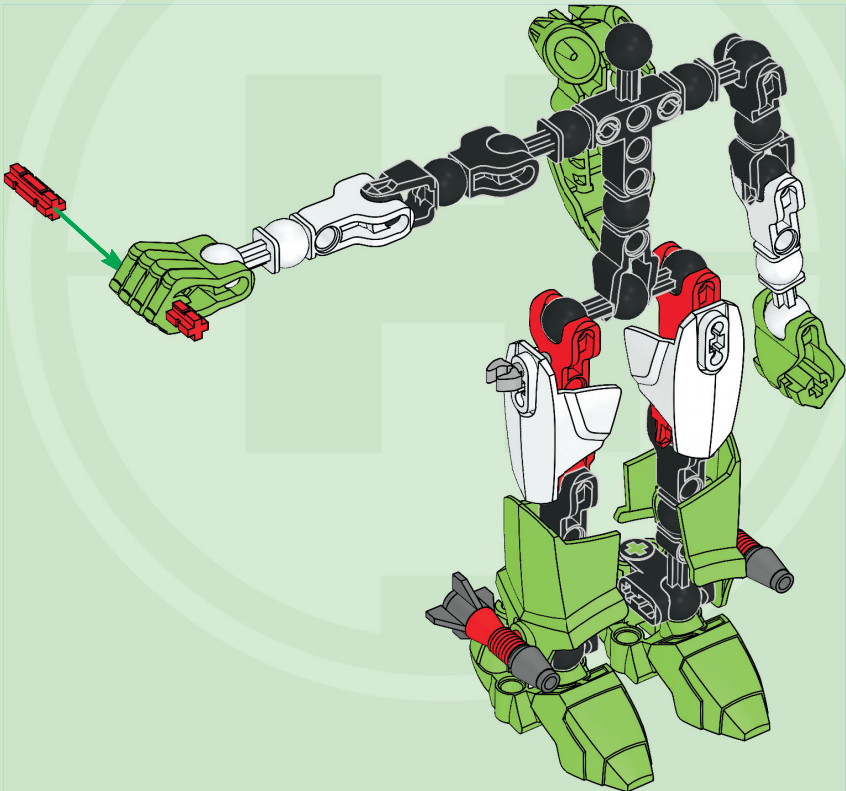

14



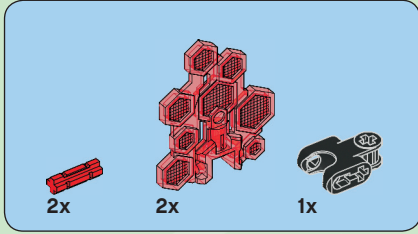

10

1

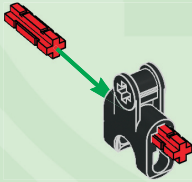

2

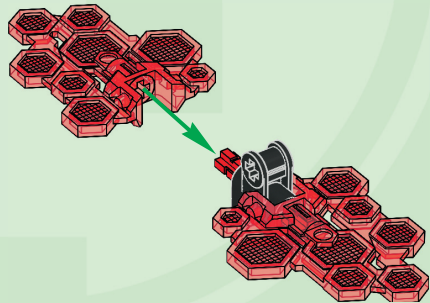

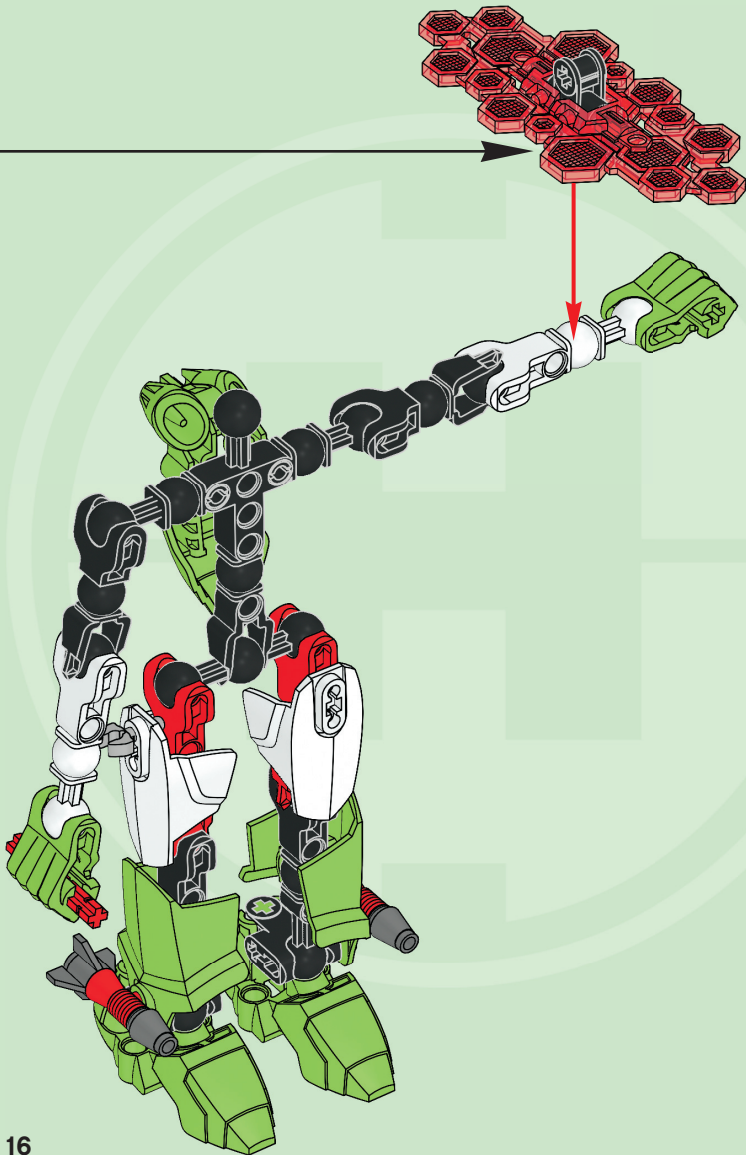

16



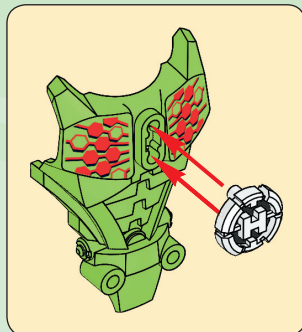
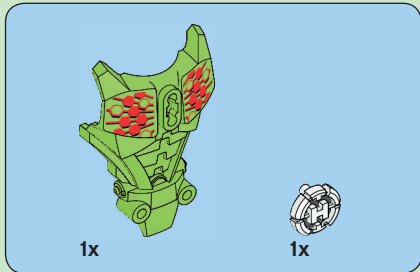

11

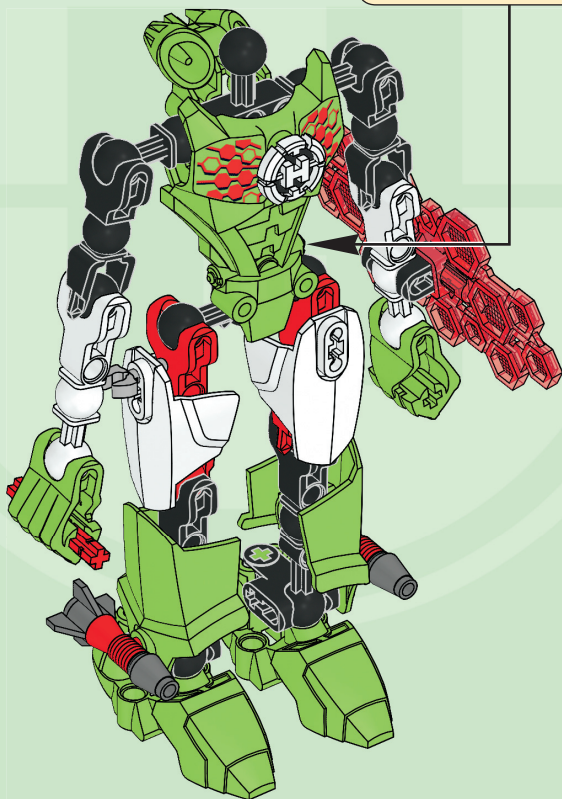

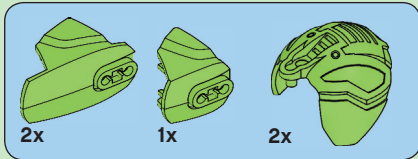

12

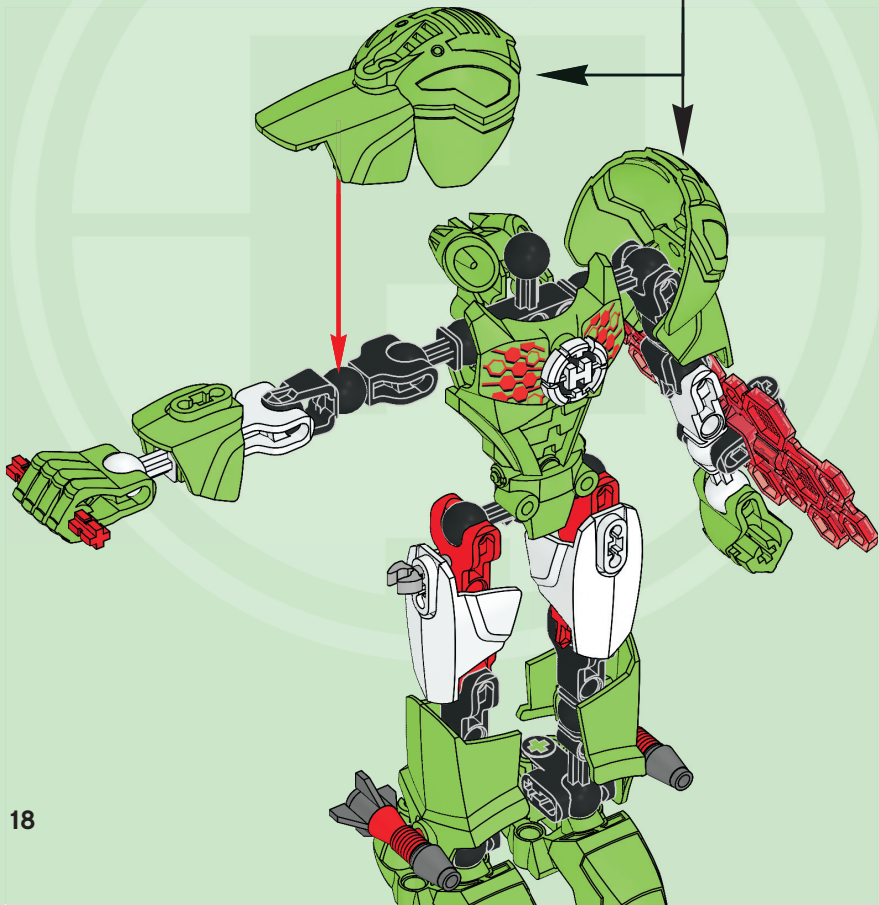
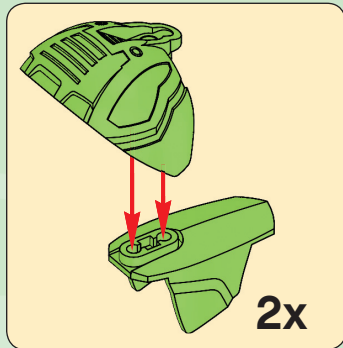

18



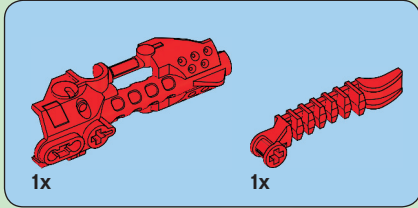

13

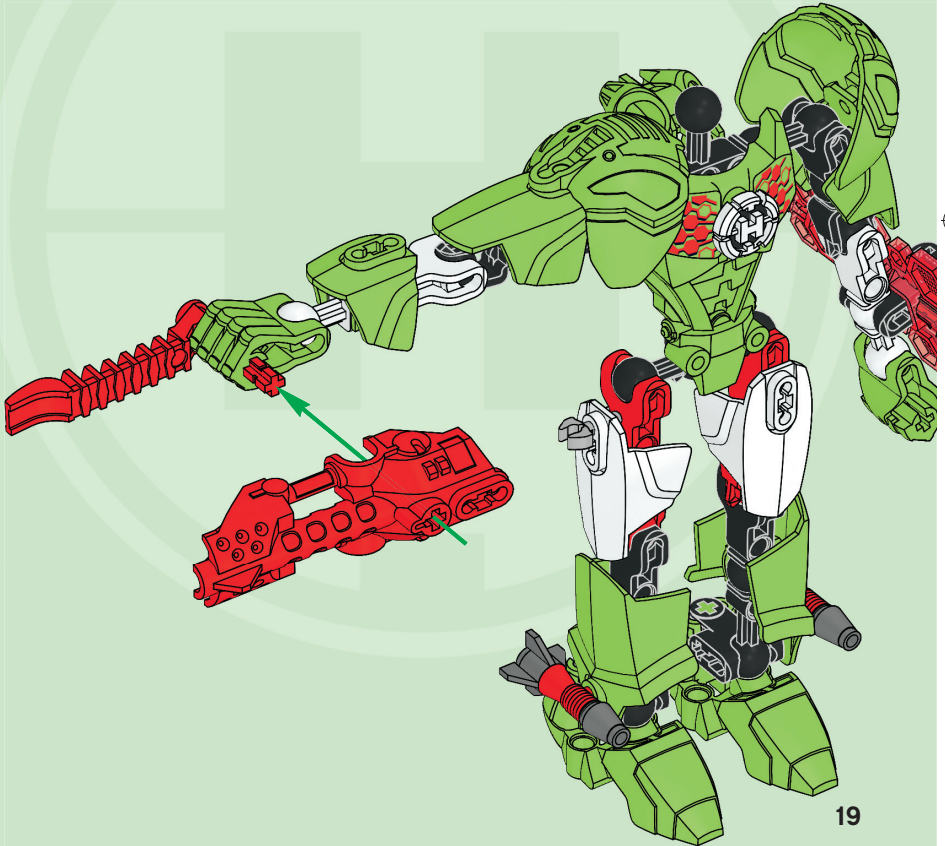

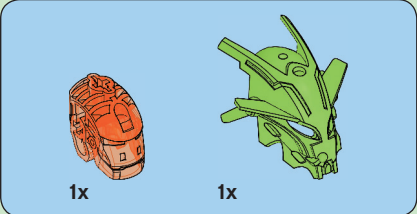

14

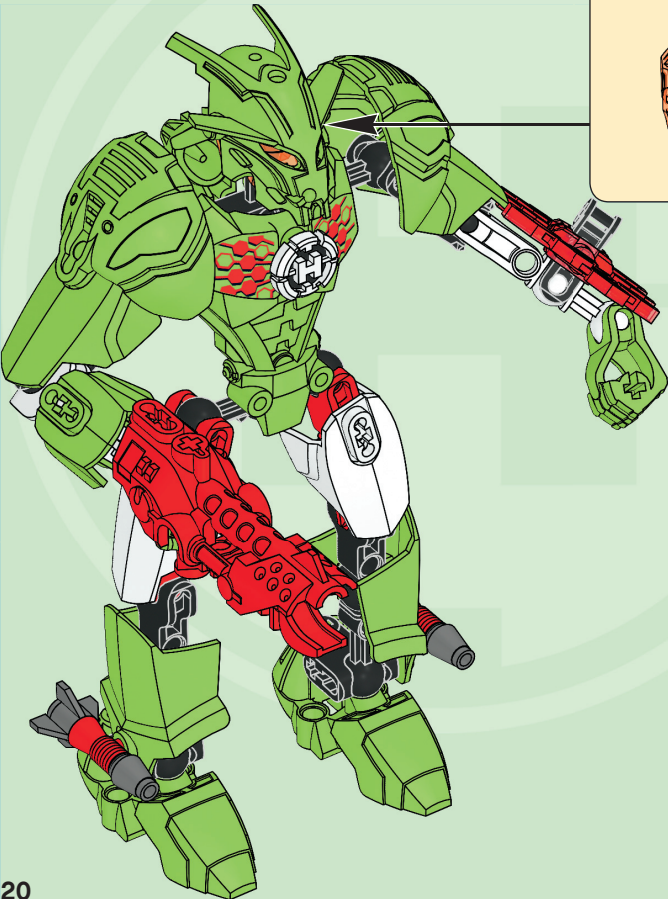
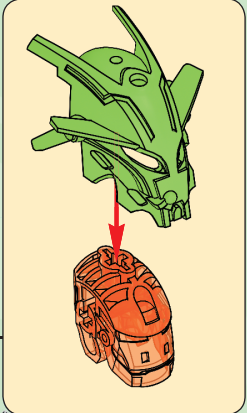

20



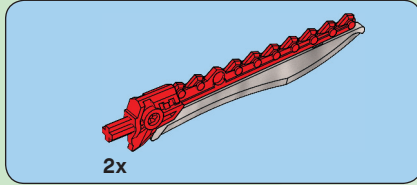

15

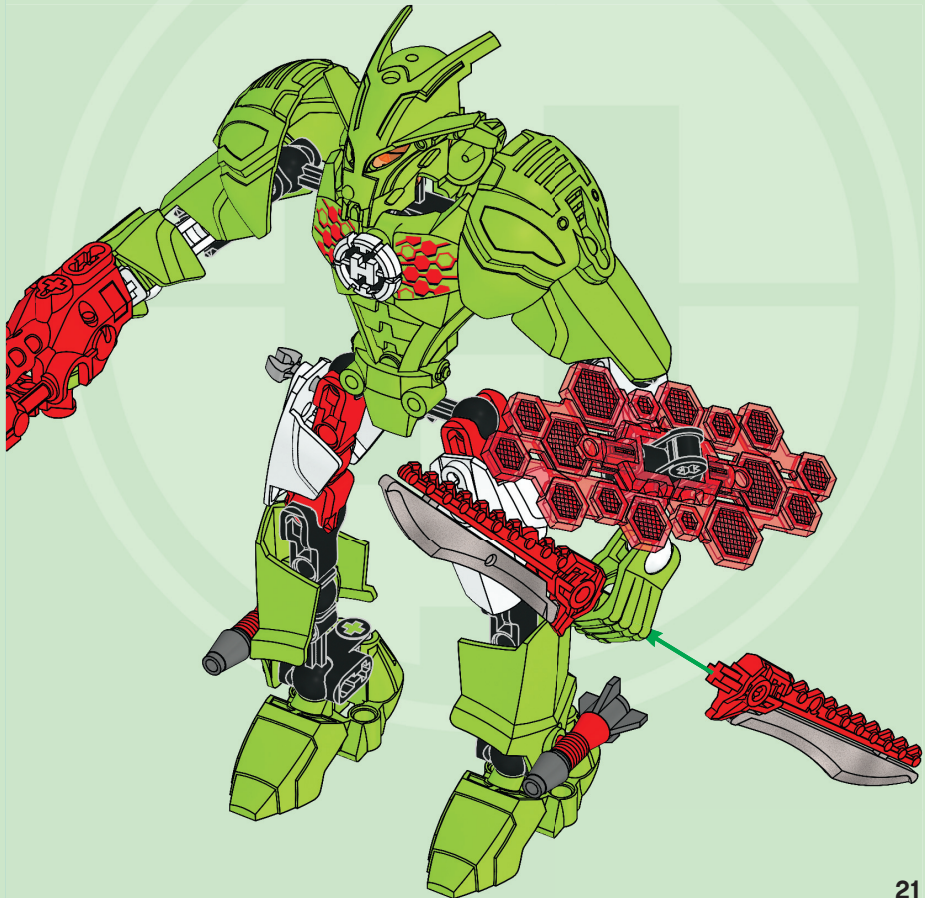

21



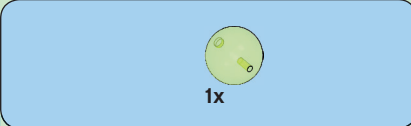

16

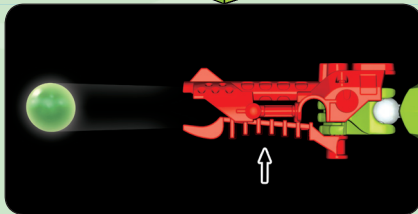
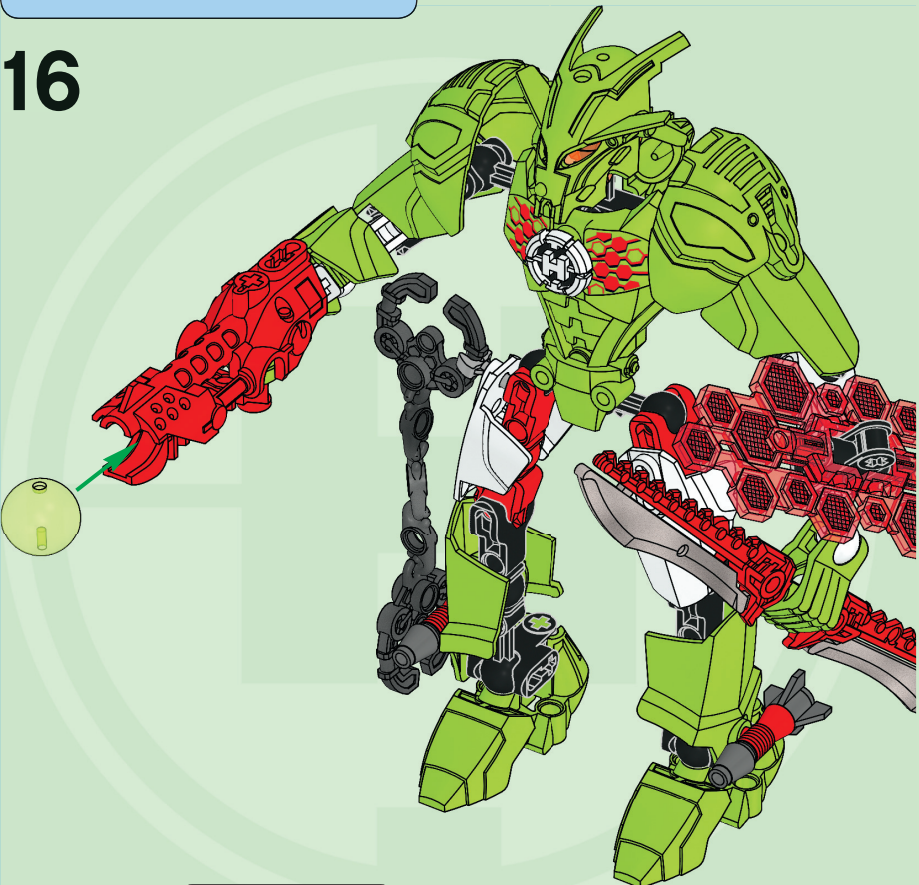

22



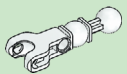

2x
4652397

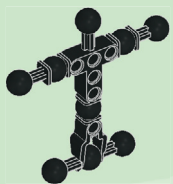

1x
4593571



1x
4632611



1x
4578992



1x
6000979



2x
4121715



2x
4626975



2x
4610911



2x
4632643



3x
4610948



1x
4655823



1x
4542590



4x
4142865



2x
4589952



2x
4529240



2x
434921



2x
4593553

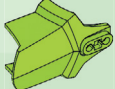

2x
4593600



2x
4212352



2x
4614228

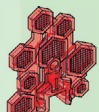

2x
4652058



2x
4652144



1x
4655587



1x
4652056



1x
4540702



3x
4582139



3x
4654504

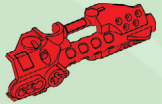

1x
4652054



2x
4652053



2x
4657296



Customer Service

Kundenservice

Service Consommateurs

Servicio Al Consumidor

www.lego.com/service or dial



: 00800 5346 5555



: 1-800-422-5346





HERO FACTORY



6228

+

=



6227





HEROFACORY.LEGO.COM/BI





6227

6228





www.LEGOclub.com

LEGO club™

FREE! GRATIS! GRATUIT!



LEGO® Club Magazine



LEGO® Club Email



SIGN UP ONLINE!
www.LEGOclub.com

**VISIT THE WORLD'S
BIGGEST LEGO® SHOP!**
www.LEGOshop.com

00800 5346 5555

1-866-534-6258 • 1-877-518-5346

US & Canada only Canada seulement



* Freephone. Mobile charges may apply. * Numéro sans frais. Des frais peuvent s'appliquer avec les téléphones cellulaires. * Gebührenfrei, Kosten für Anrufe aus Mobilfunknetzen können abweichen. * Gratis telefoonnummer vanaf vaste lijn. * Det er et gratis nummer, når du ringer fra fasttelefon. * Det är gratis, när du ringer från en fast telefon. * Numéro sans frais. Des frais peuvent s'appliquer avec les téléphones portables.

B1112



WIN!

Go to www.LEGOsurvey.com/product
to fill out a survey for a chance
to win a cool LEGO® Product.
No purchase necessary.
Open to all residents where not prohibited.



www.LEGO.com



www.LEGOsurvey.com/product

GEWINNE!

Nimm an der Umfrage auf
www.LEGOsurvey.com/product
teil und hab die Chance ein cooles
LEGO® Produkt zu gewinnen!

Die Teilnahme am Gewinnspiel führt zu keinerlei
Kaufverpflichtungen. Teilnahme in allen nicht
ausgeschlossenen Ländern möglich.

WIN!

Ga naar www.LEGOsurvey.com/product,
vul een enquêteformulier
in en maak kans op een
cool LEGO® product.

Geen aankoopverplichting.
Iedereen mag deelnemen, uitgezonderd
ingezetenden van landen waar een
enquêteverbod geldt.

GAGNE!

Visite www.LEGOsurvey.com/product
pour répondre à un
questionnaire et avoir une
chance de gagner un produit
LEGO® très cool!

Aucune obligation d'achat.
Ouvert à tous les résidents des pays
autorisés.

当てよう!

www.LEGOsurvey.com/product
にアクセスして、
アンケートにご記入ください。
当選者にはレゴ製品を
差し上げます。

お買い上げの必要はありません。
禁止されていない限り、すべての皆様にご利用いただけます。

6002550

LEGO and the LEGO logo are trademarks of the/sont des marques de commerce de/
son marcas registradas de LEGO Group. ©2012 The LEGO Group.