

1x
300426

2x
362326

1x
379526

4x
4598528

1x
4144024

1x
4160869

1x
4161332

2x
4531412

1x
6083701

1x
6081356

1x
4522653

1x
4143875

2x
4562148

1x
6081345

2x
4143005

1x
6081301

1x
6051918

1x
6064345

2x
614140

4x
4567338

2x
6047418

1x
4619636

1x
4211087

1x
4211046

1x
4658974

1x
4636417

2x
6019987

1x
6062648

2x
4540386

2x
4211398

1x
4212363

2x
4219256

1x
6009014

1x
4226995

2x
4520320

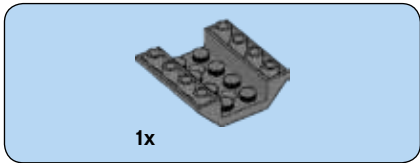
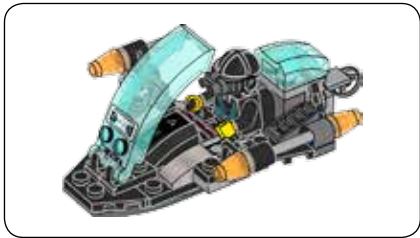

1

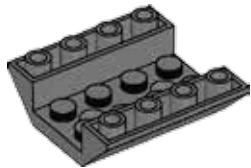

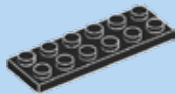

1x

2

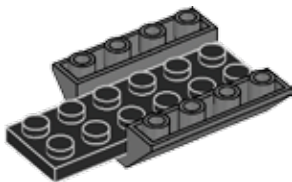

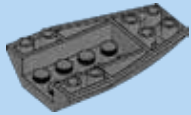

1x

3





1x



1x

4

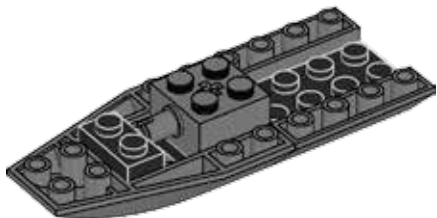

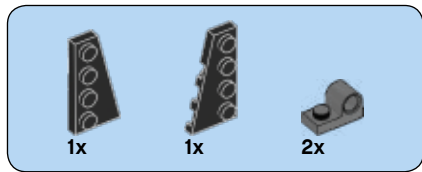

5

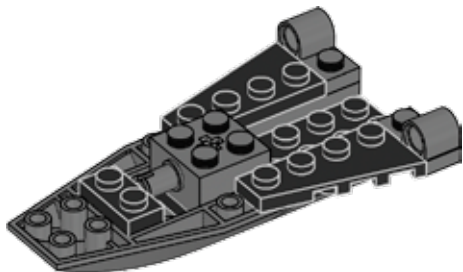

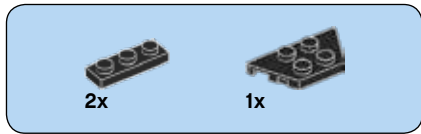

6





2x



2x

7

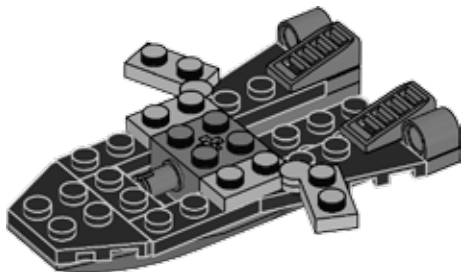

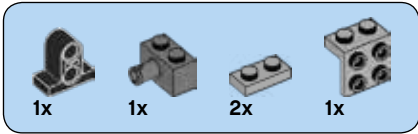

8

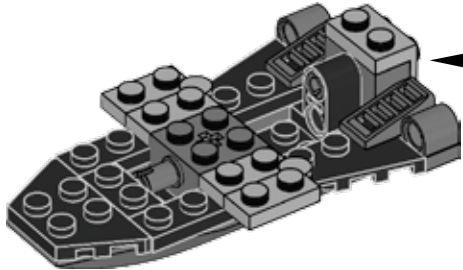
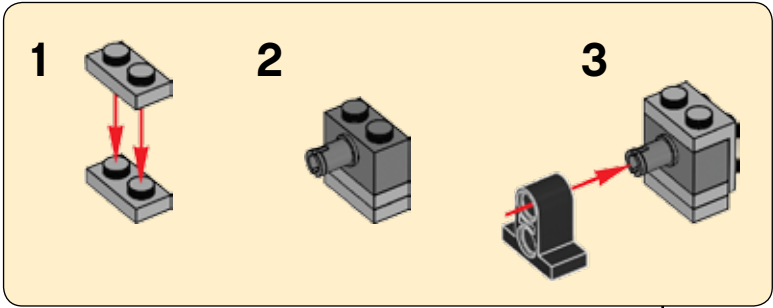

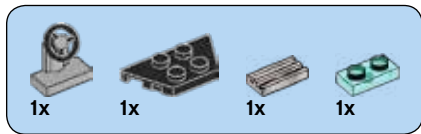

9

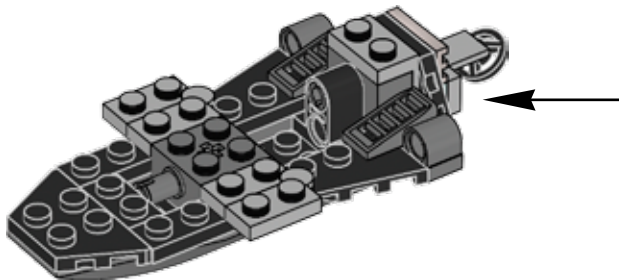
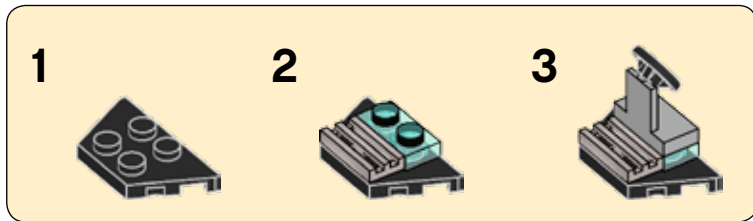



1x



2x



2x

10

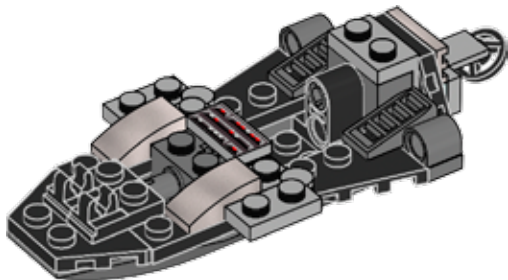



11

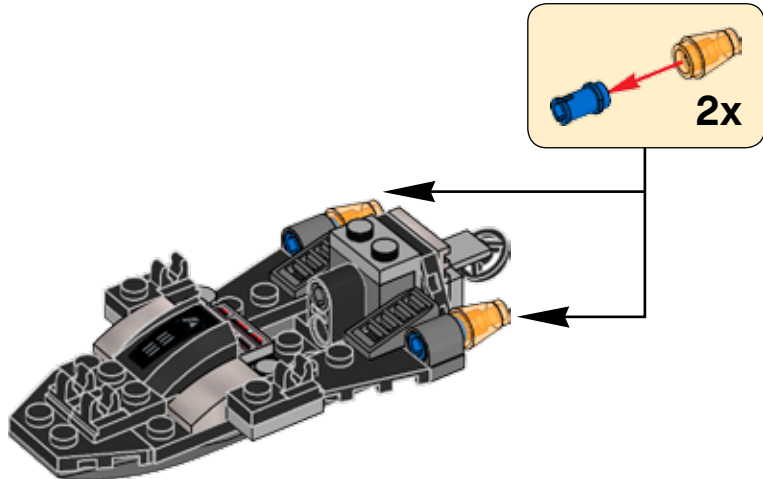



2x



1x

12

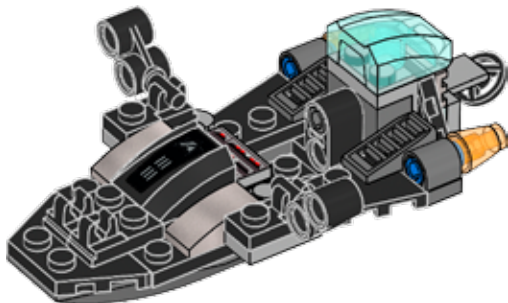



2x

13

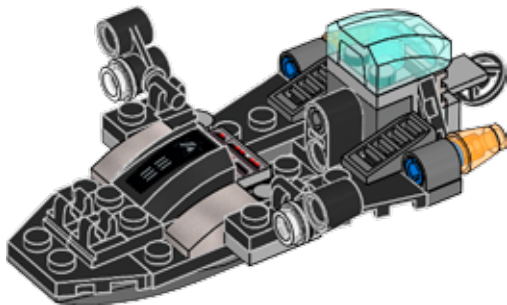

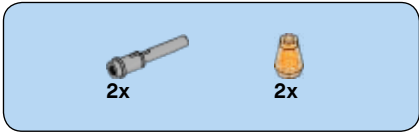

14

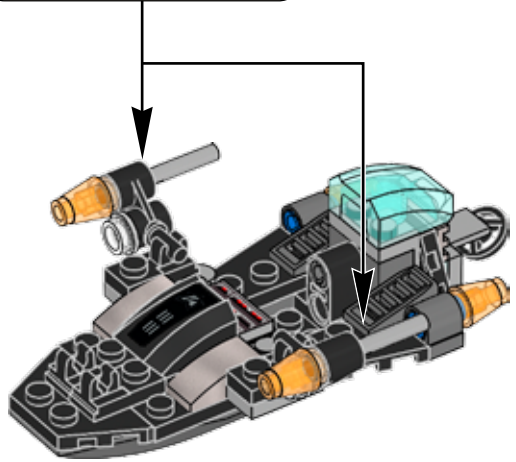
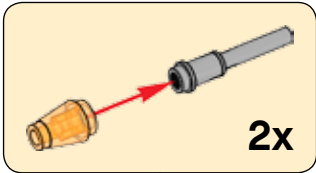



1x

15

