



THE NINJAGO MOVIE

70608





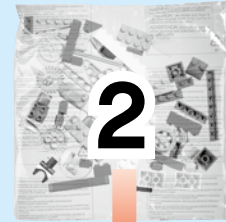

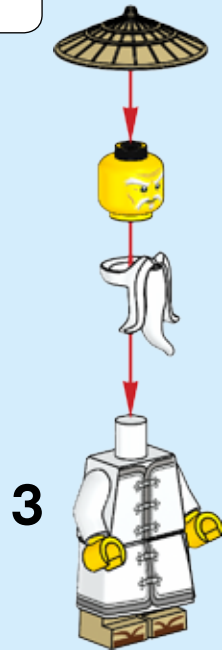
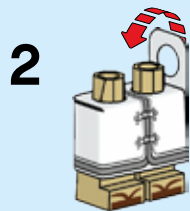
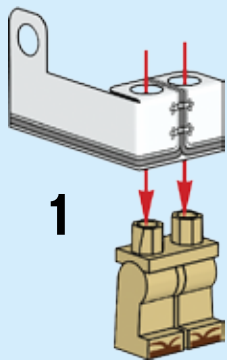
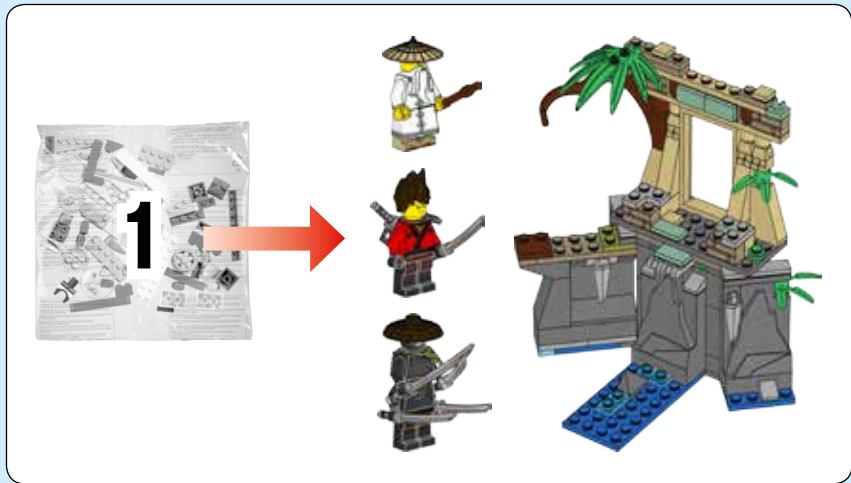

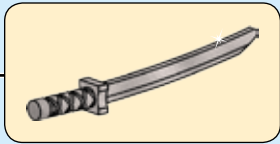

1

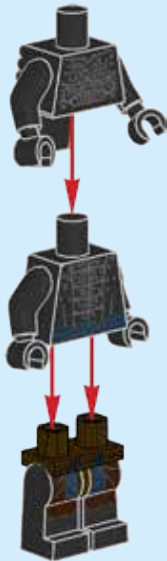

2



3



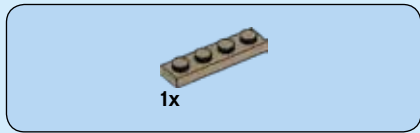

1

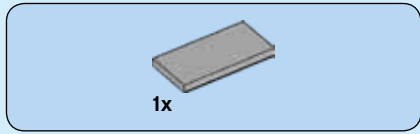
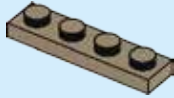

2

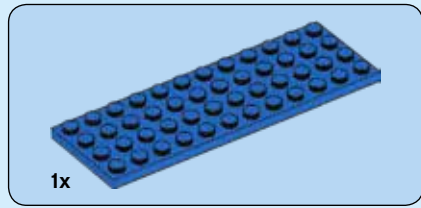
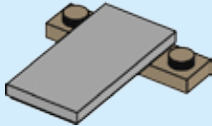

3

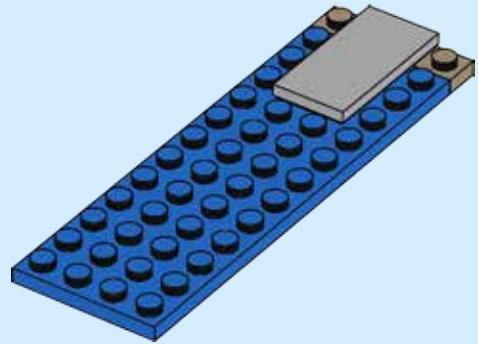

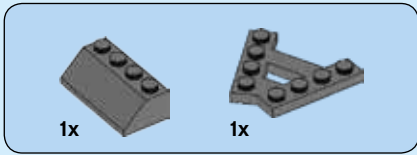

4

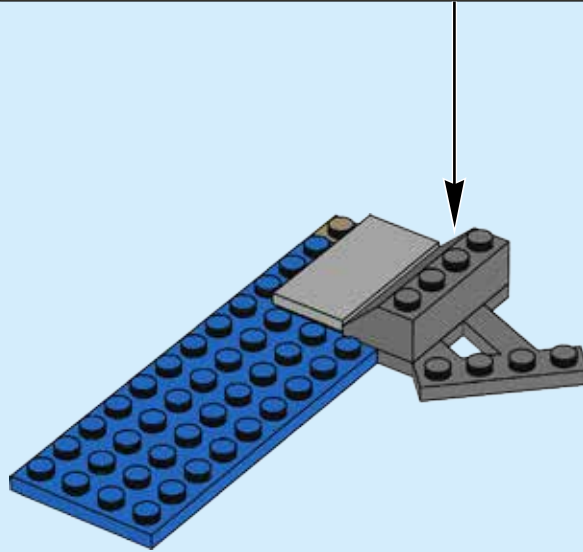
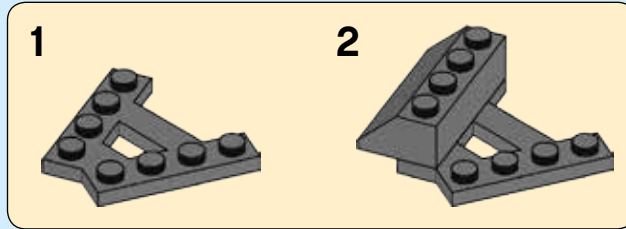

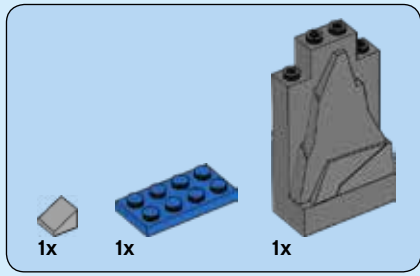

5

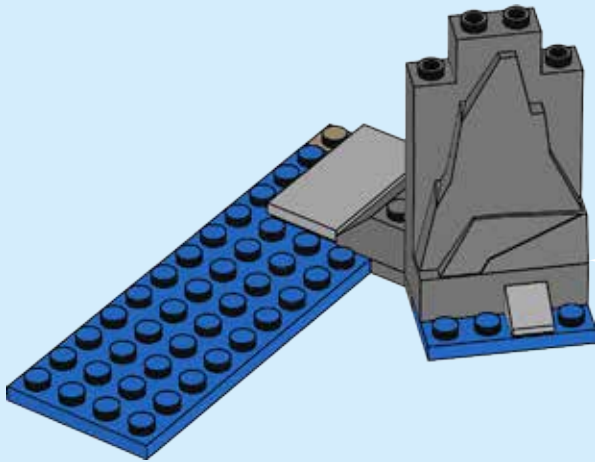
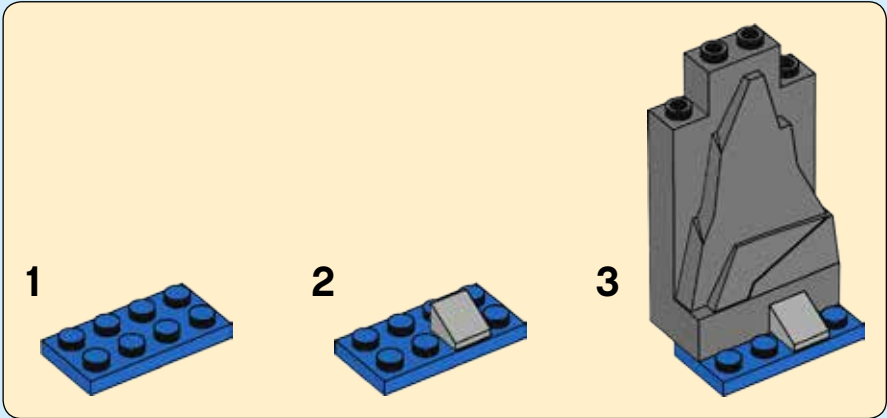

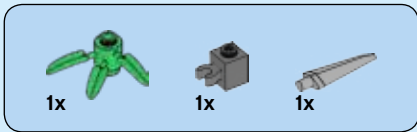

6

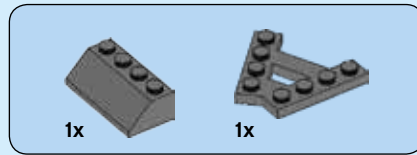
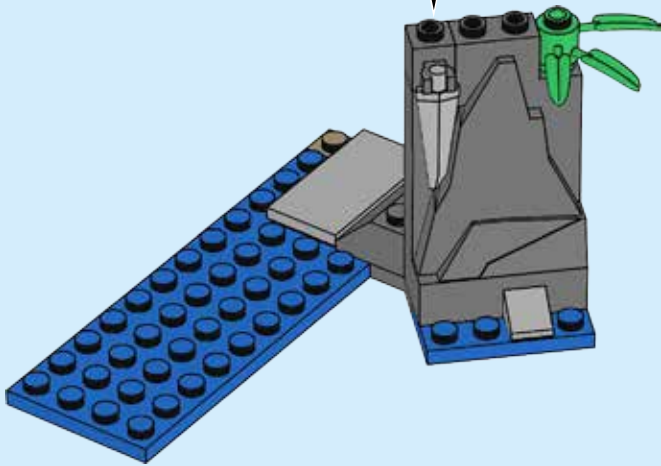
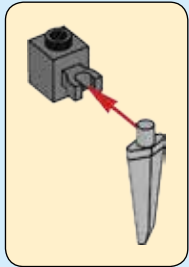

7

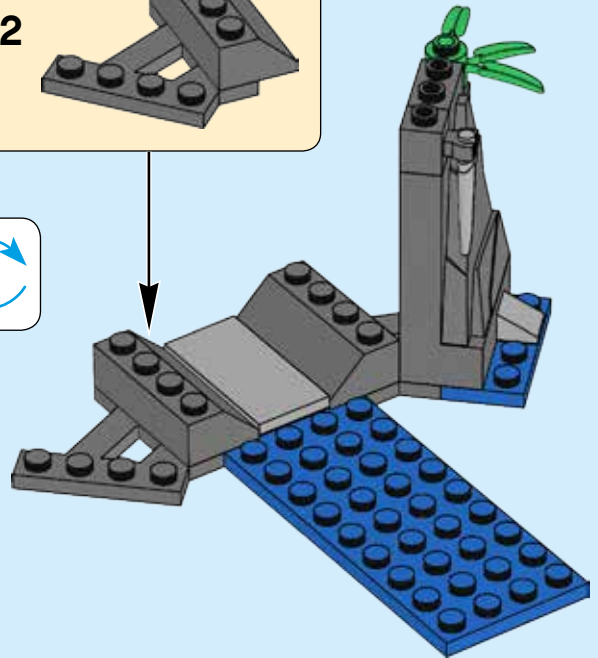
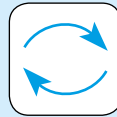
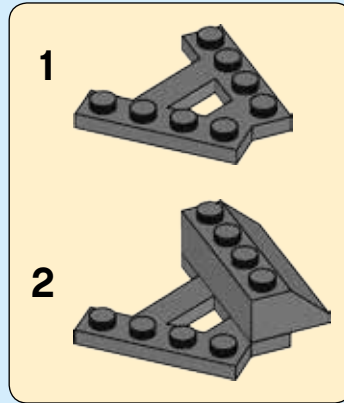

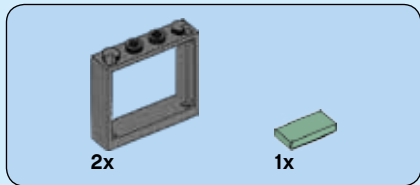

8

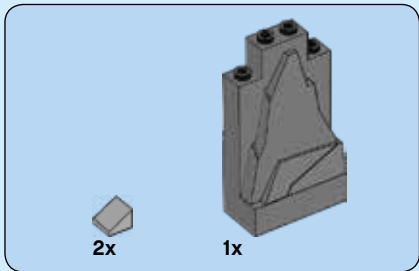

9

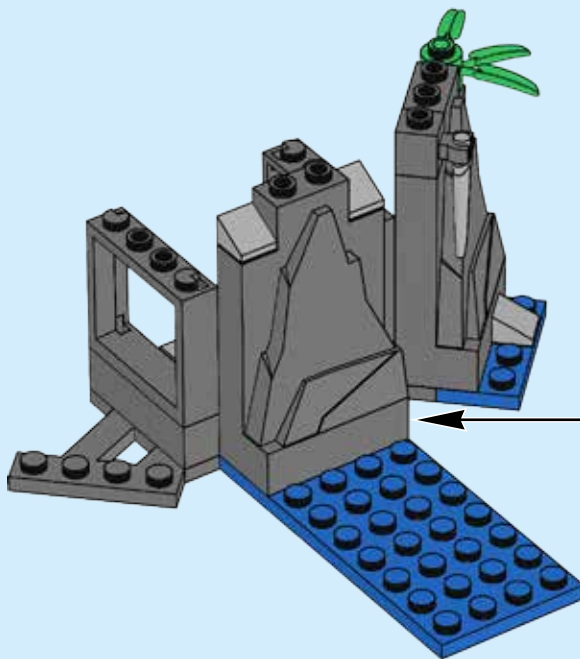
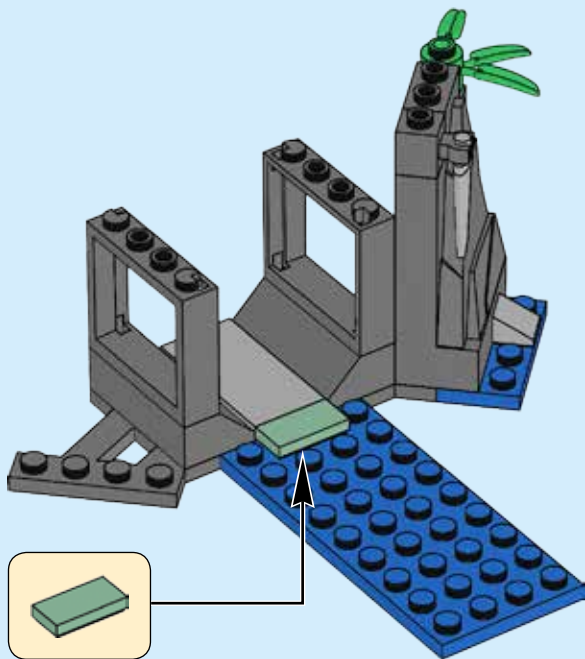
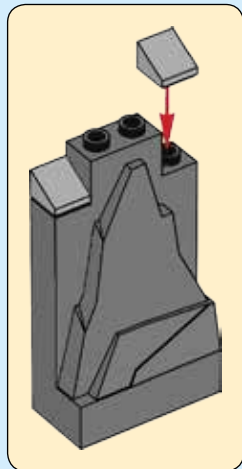



10

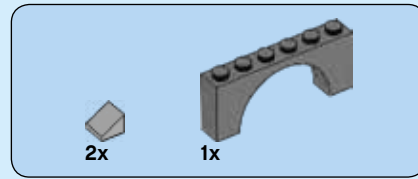
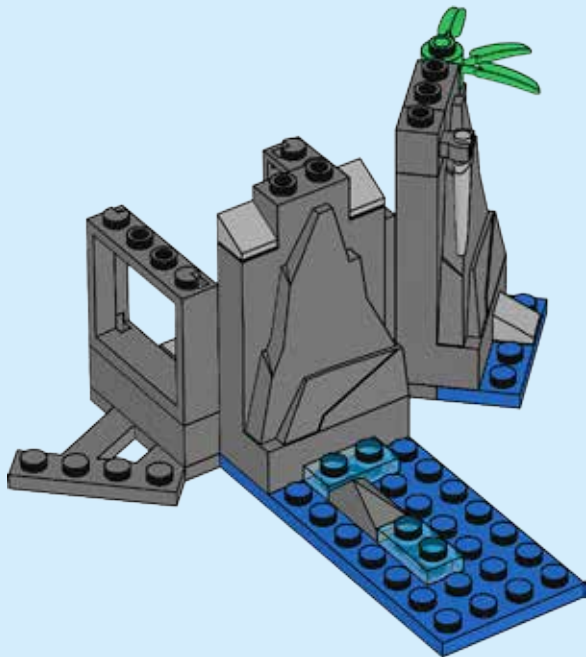

11

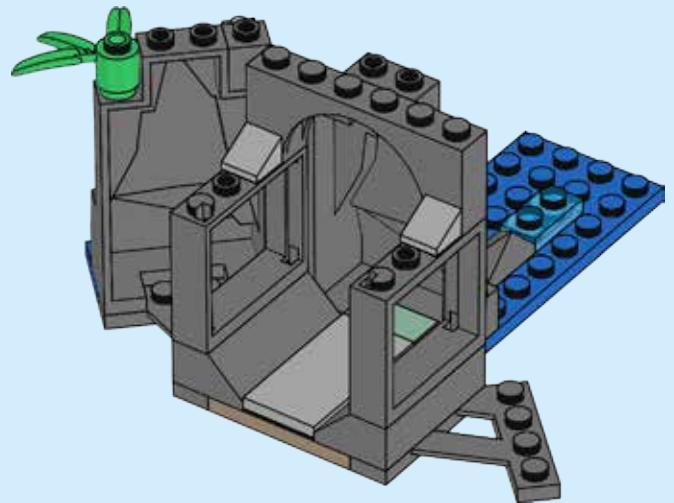
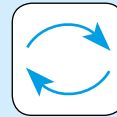

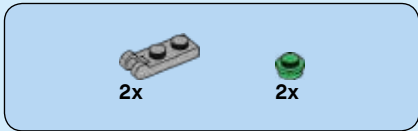

12

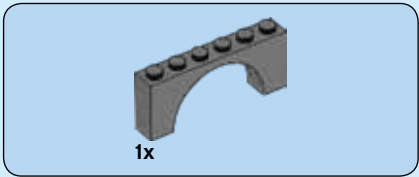
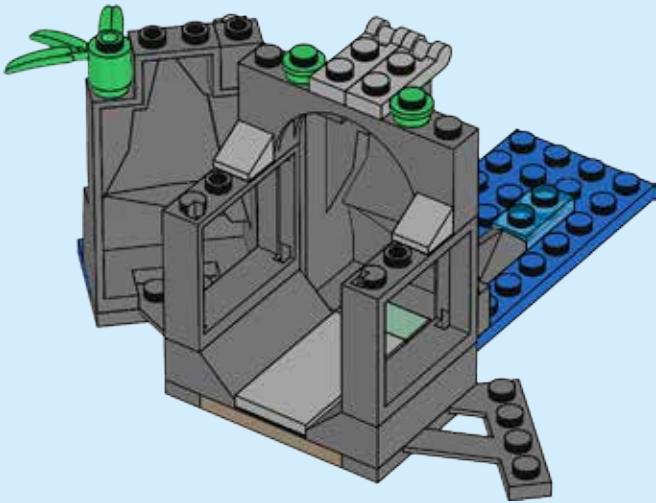

13

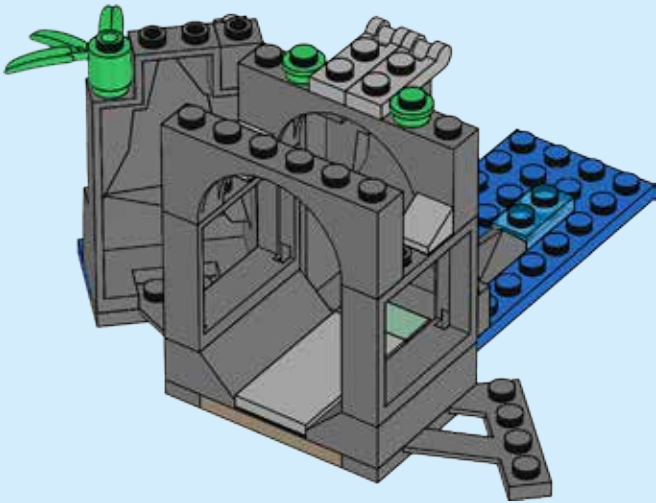

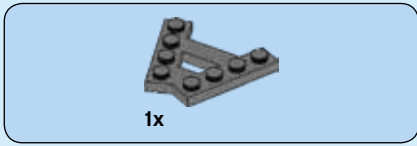

14

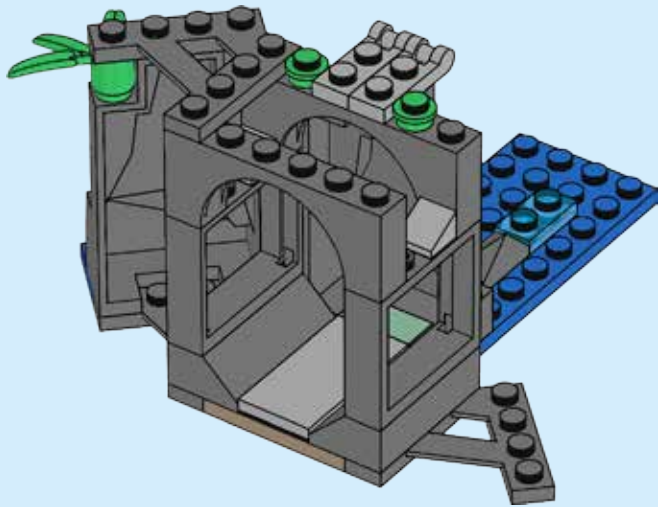

15

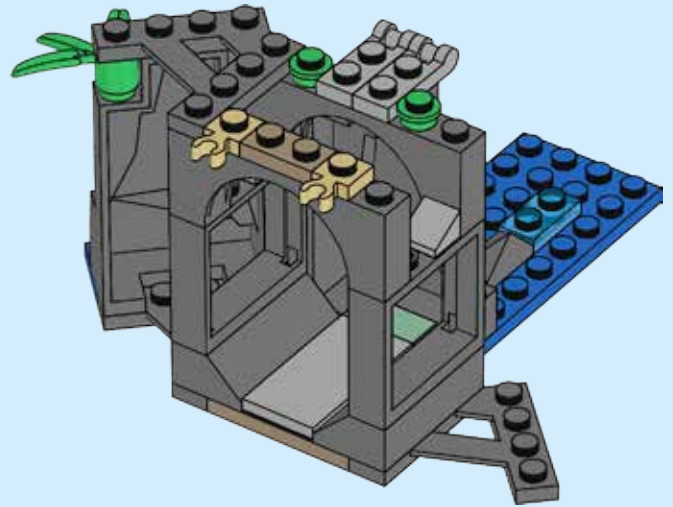

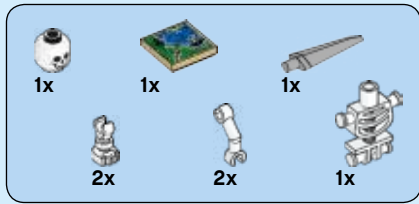

16

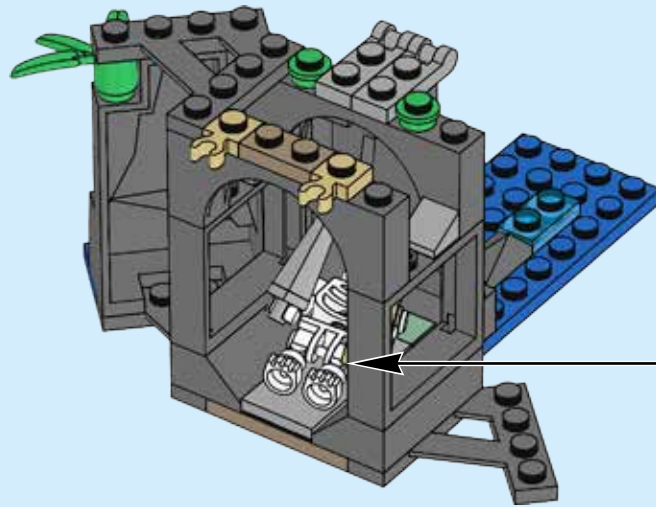
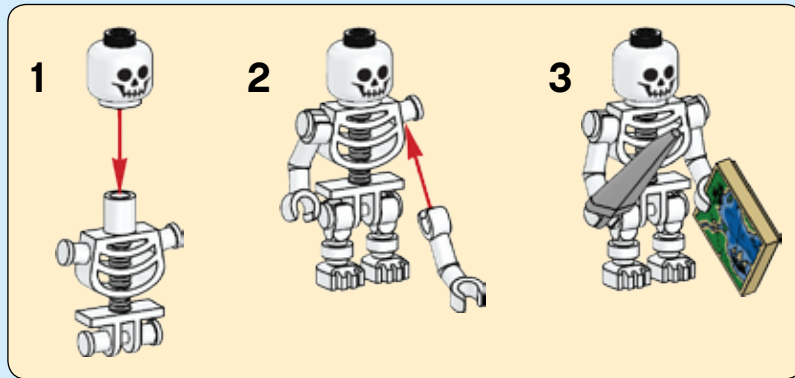

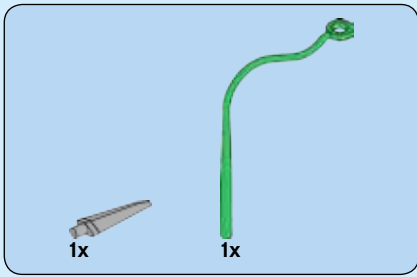

17

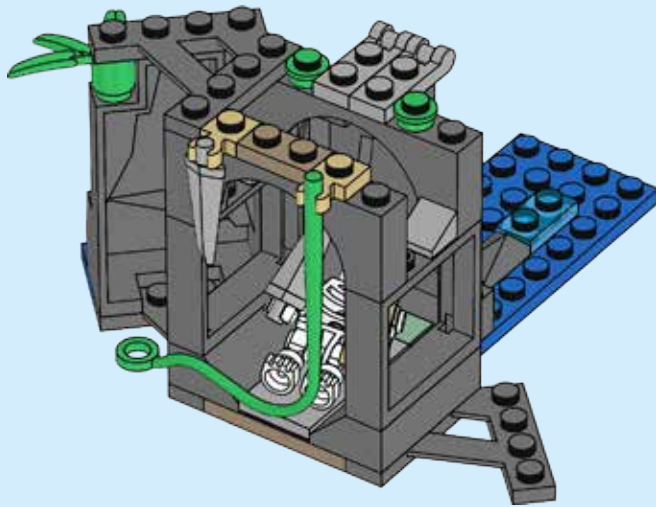

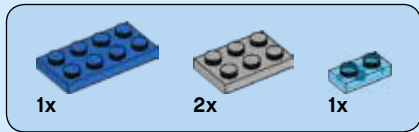

18

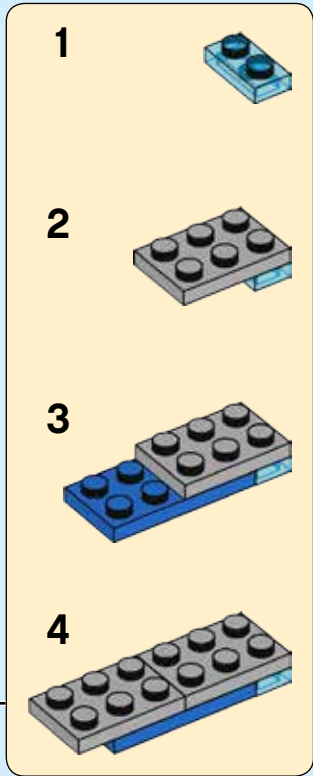
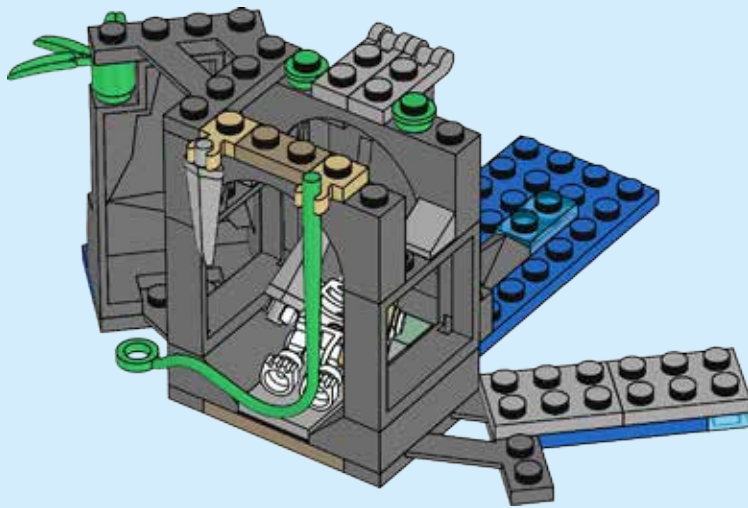

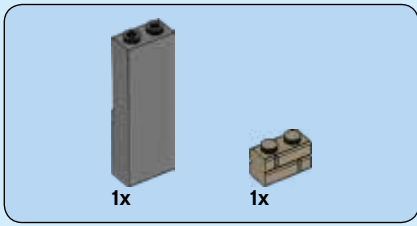

19

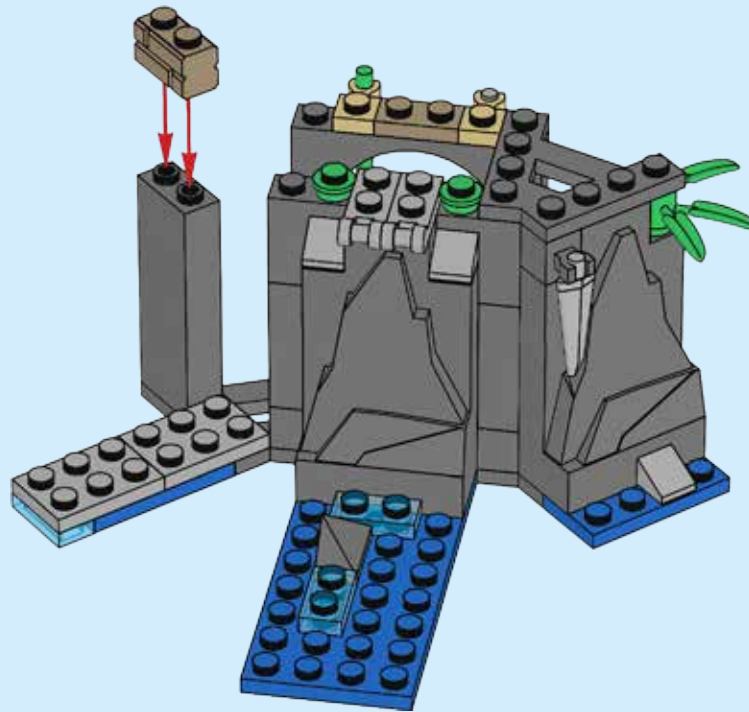
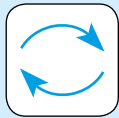

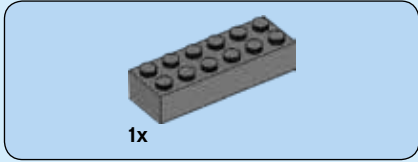

1x

20

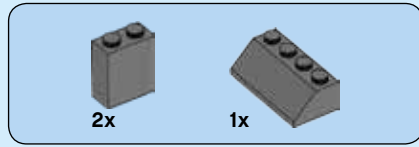
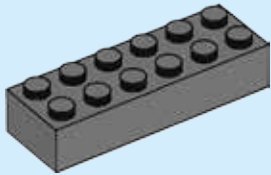

2x

1x

21

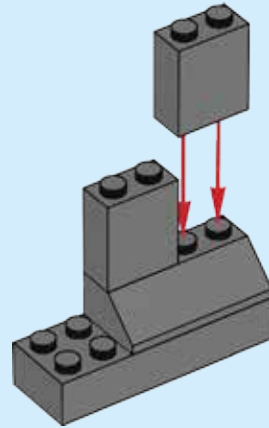



22

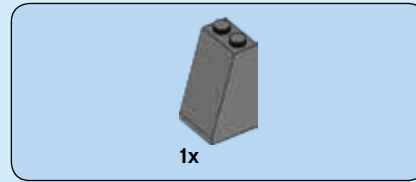
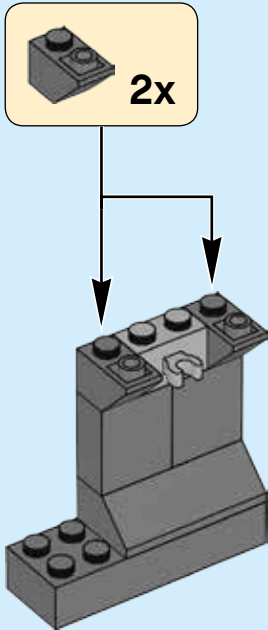

23

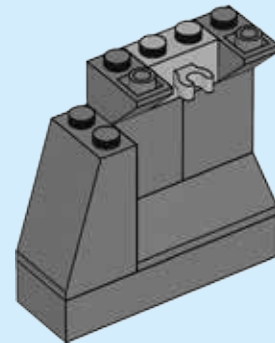

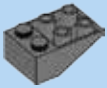

1x

24

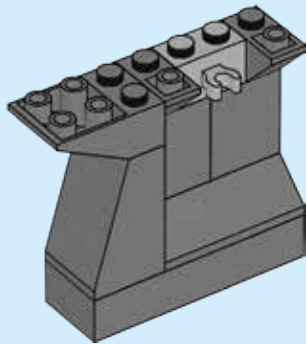

1x

25

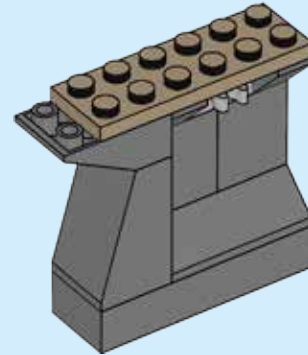

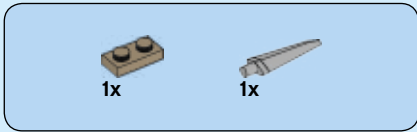

26

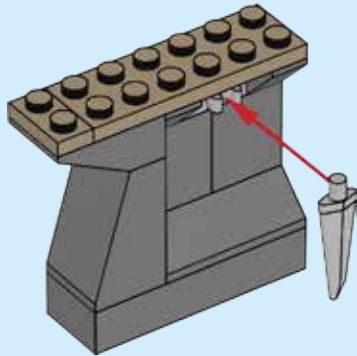

27

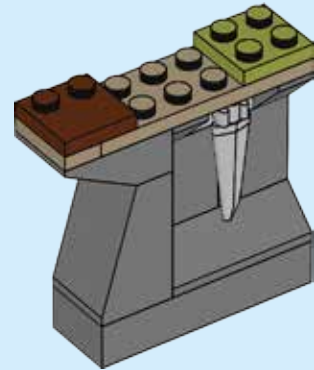

28

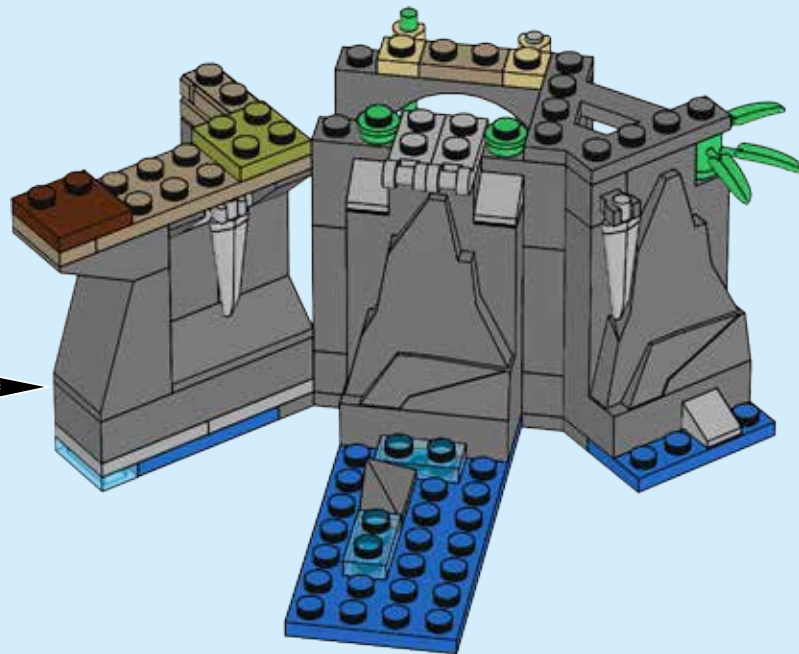

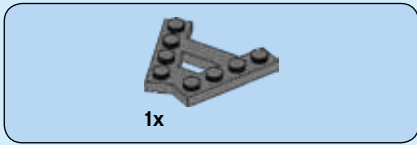

29

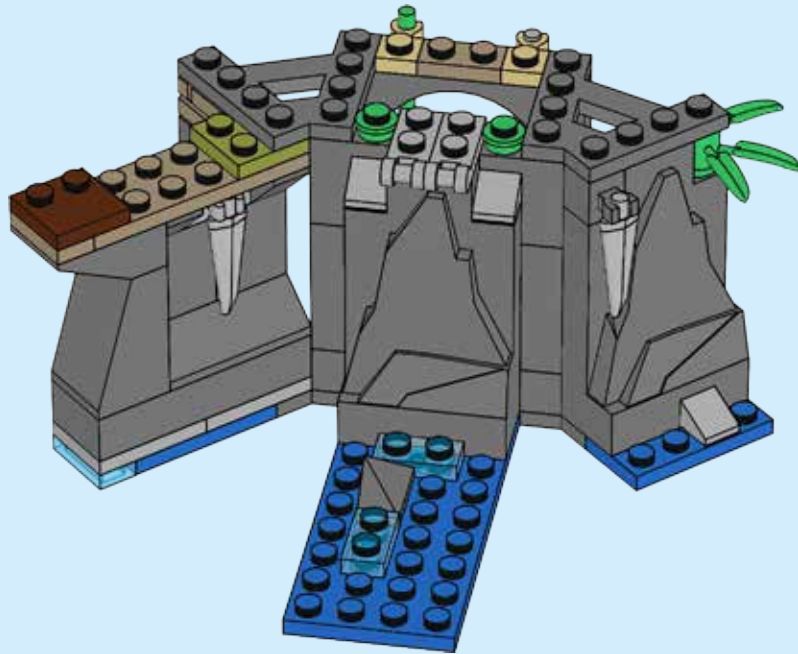

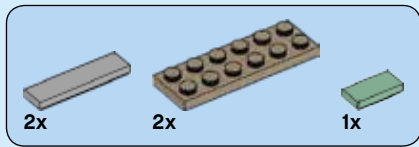

30

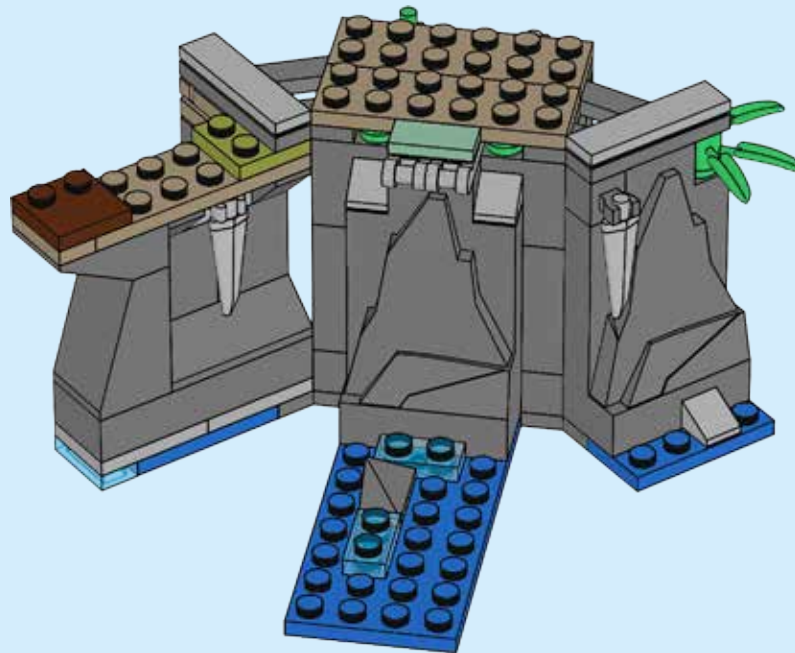

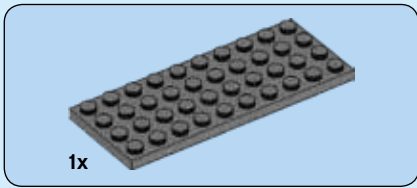

31

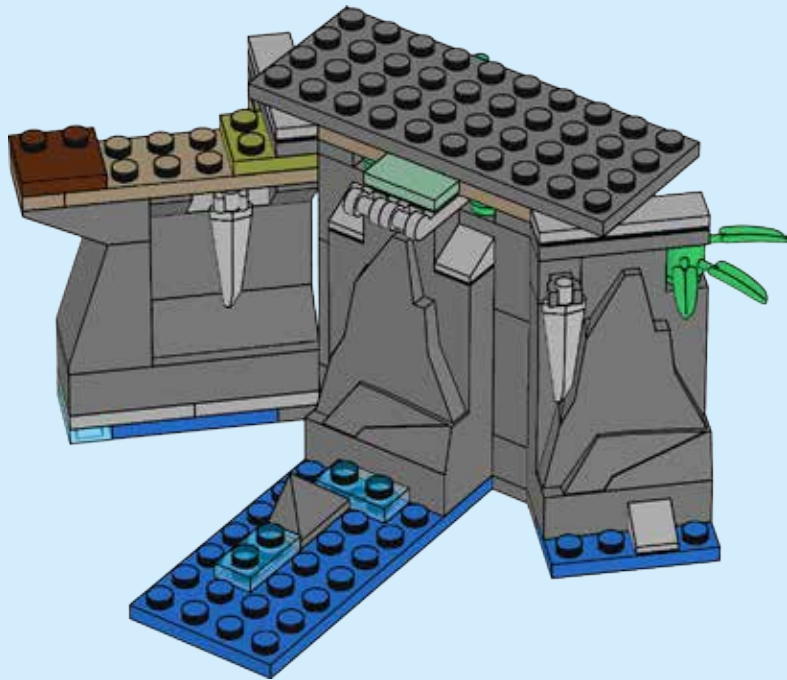

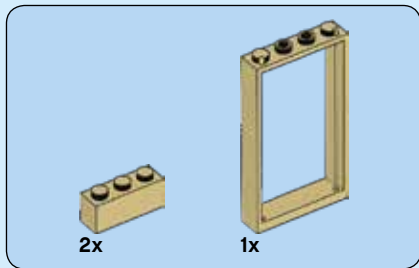

32

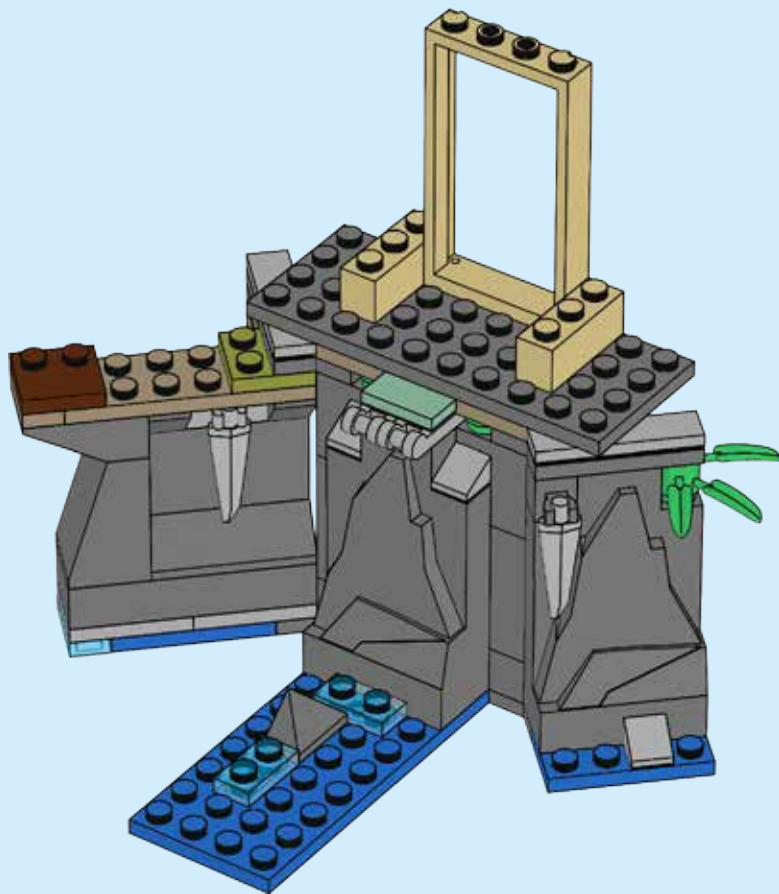



4x

33

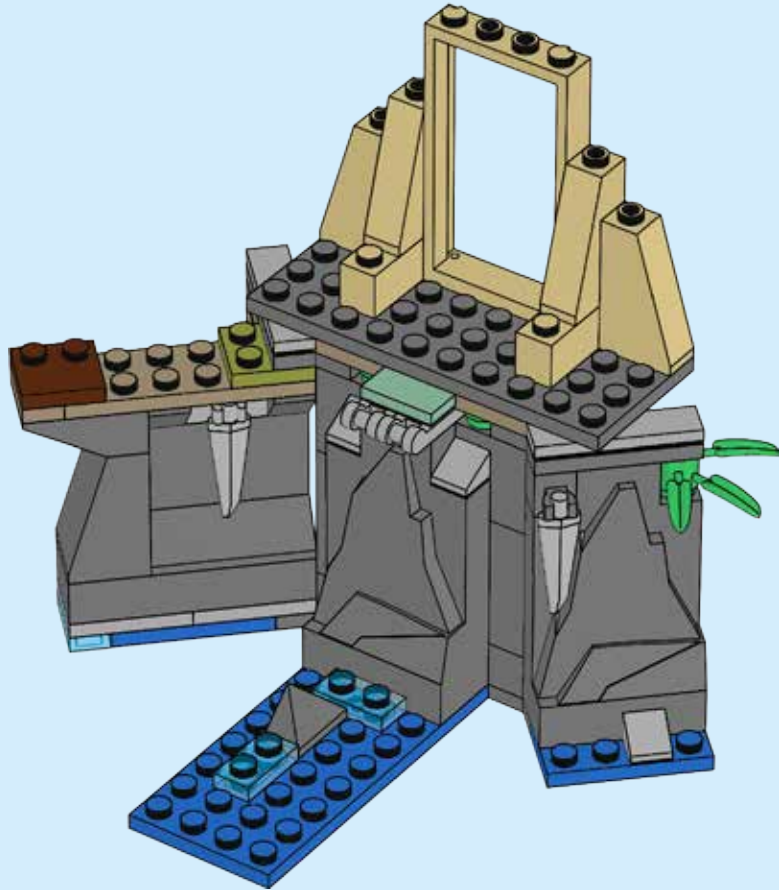

2x 1x 1x

34

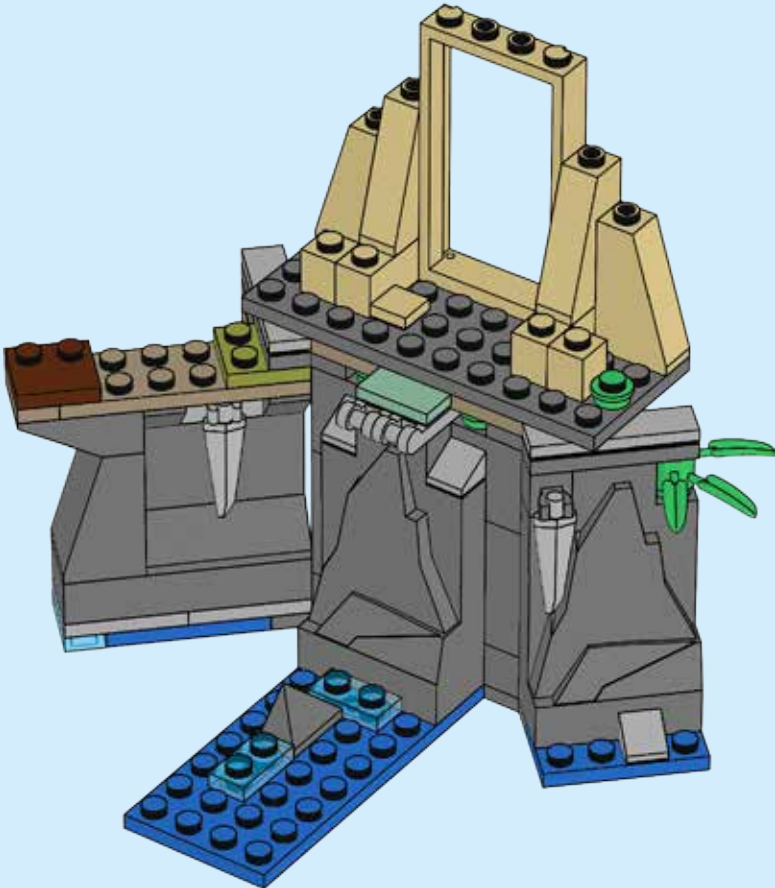



1x



2x

35

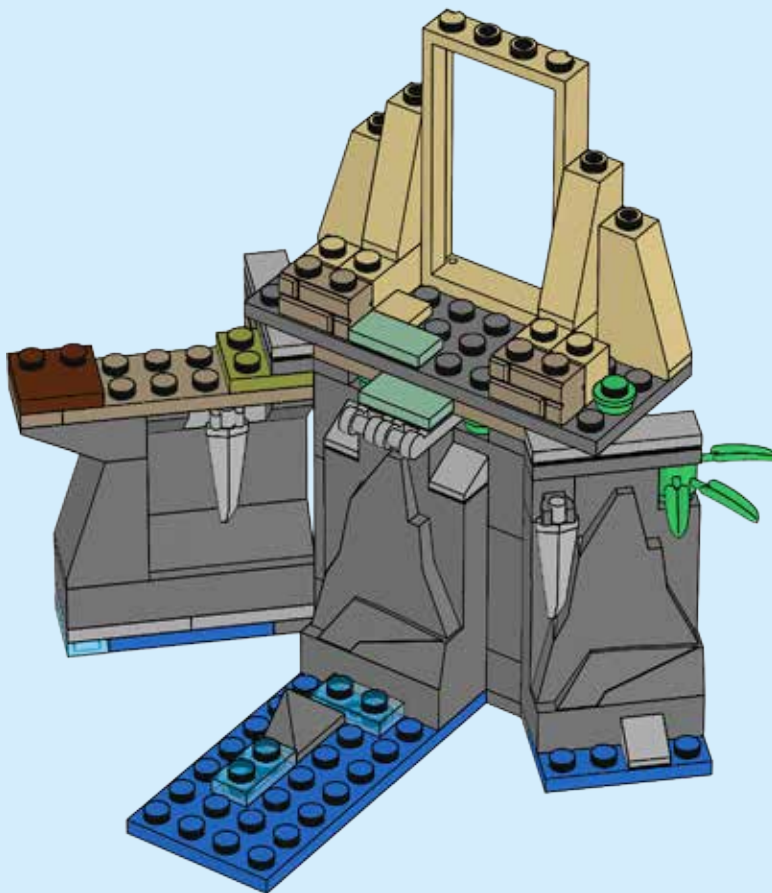



36

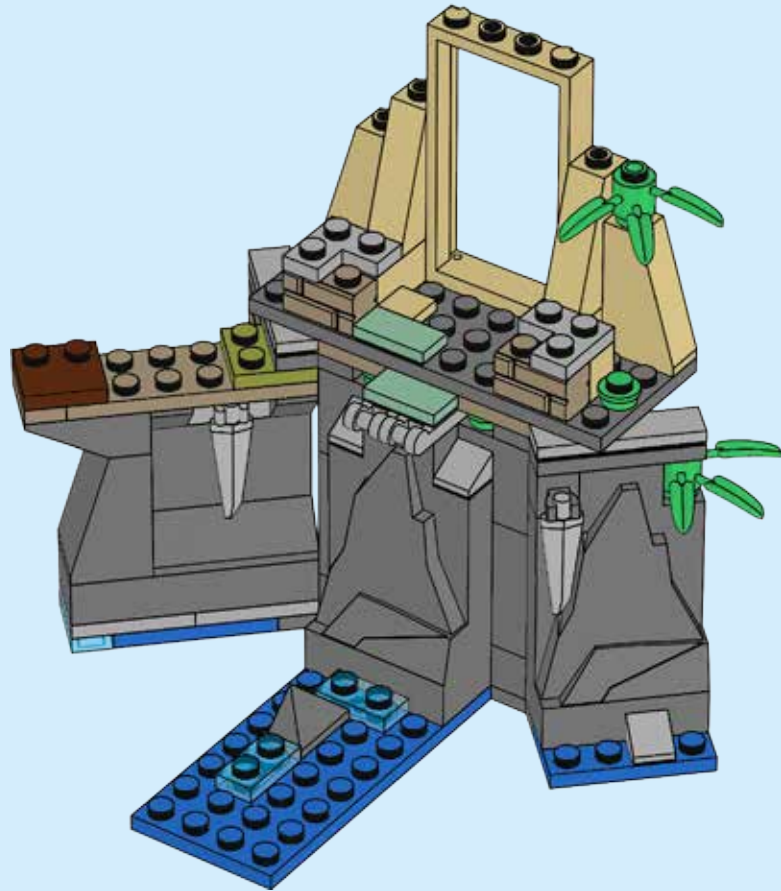



3x

37

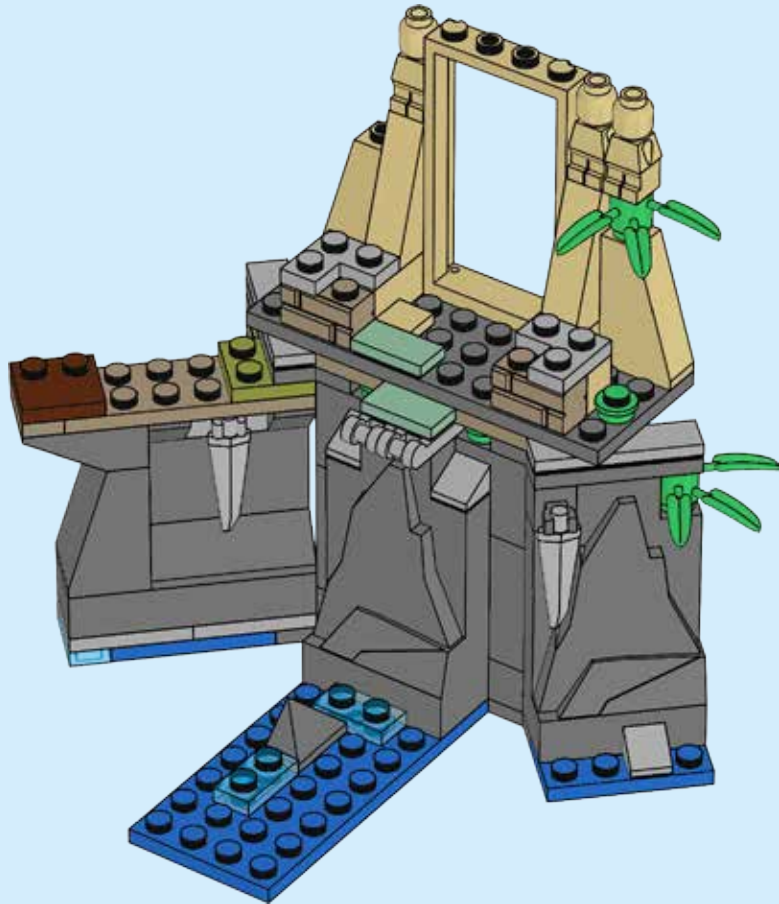

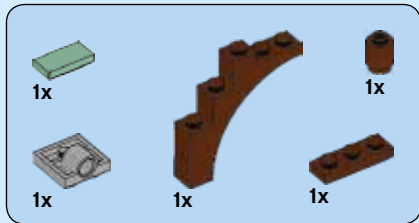

38

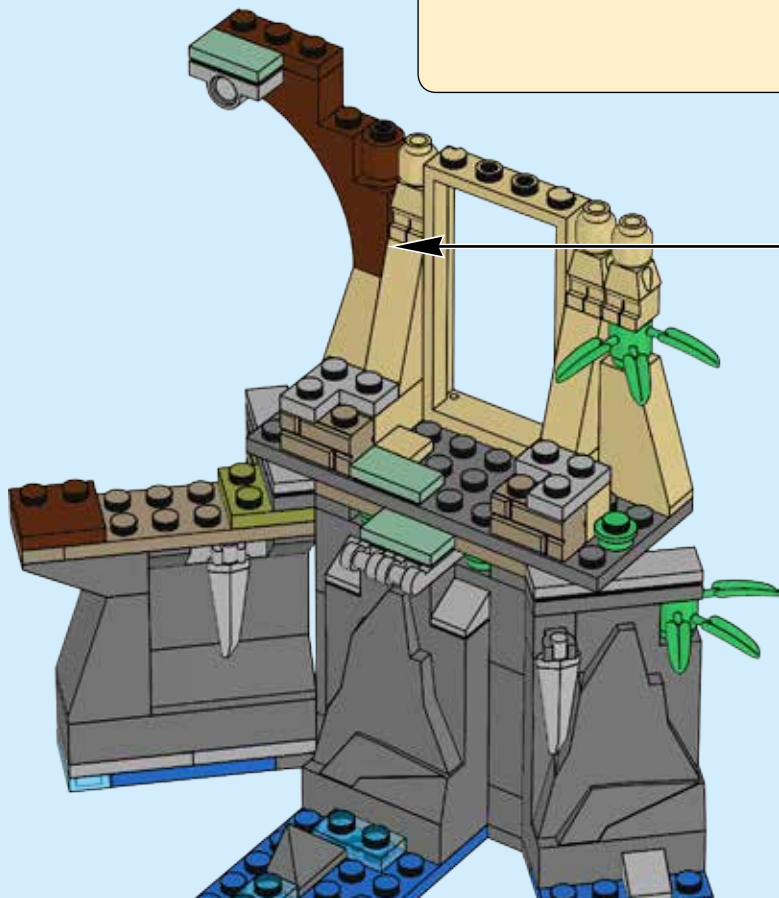
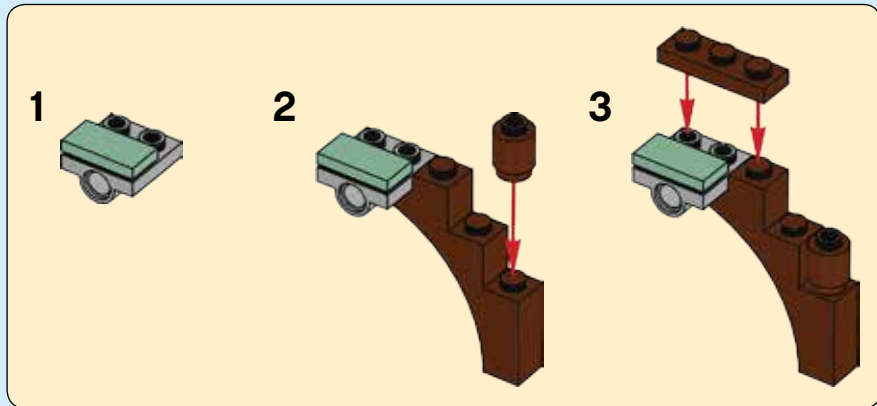

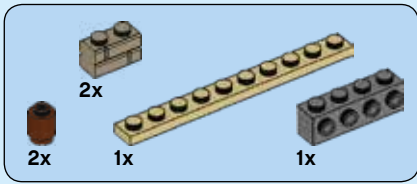

39

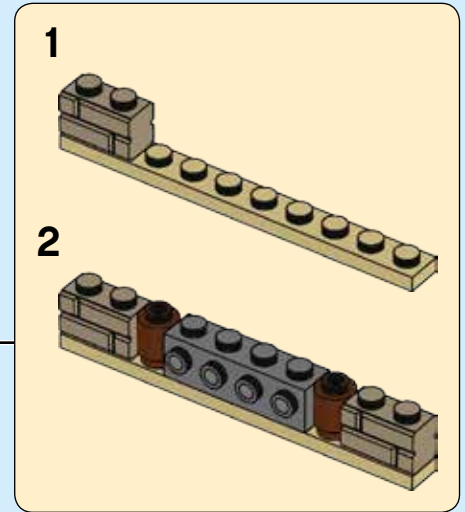
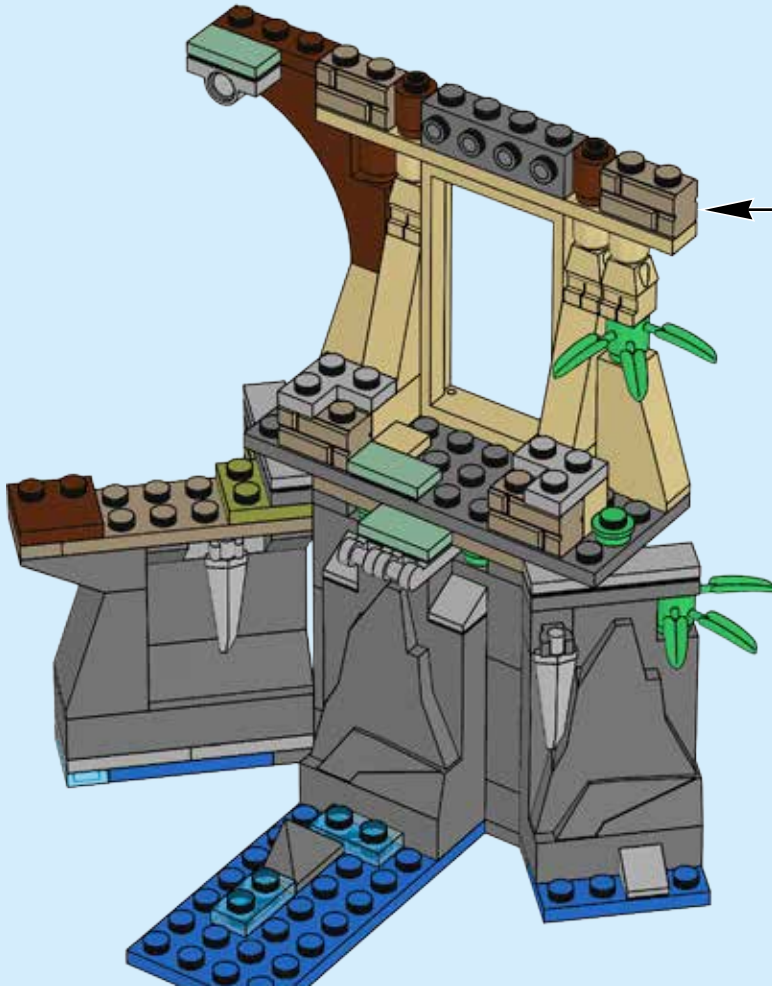

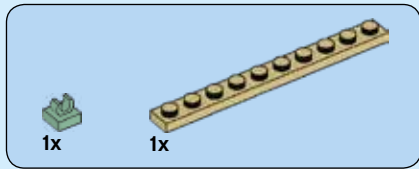

40

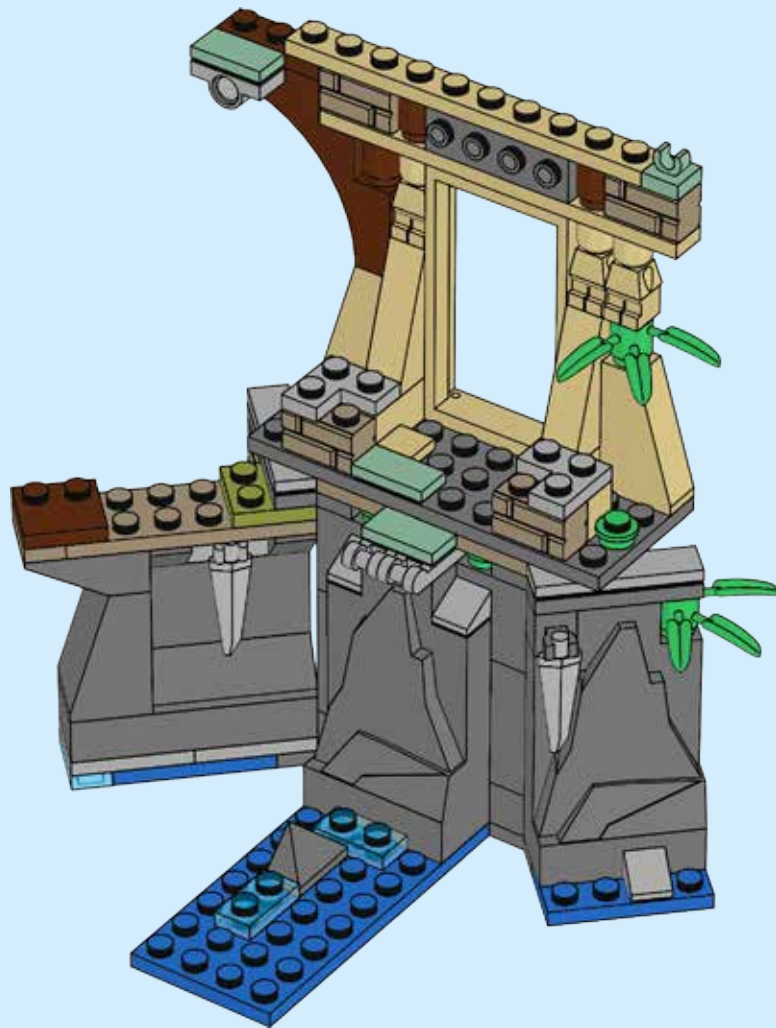



2x



1x

41

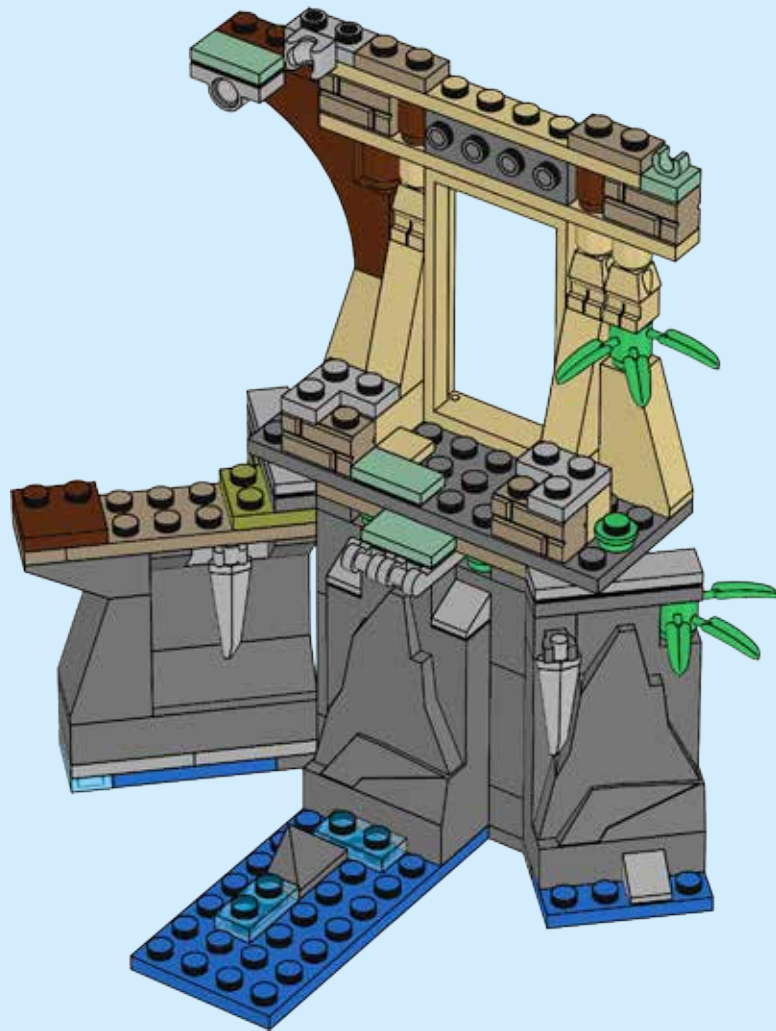

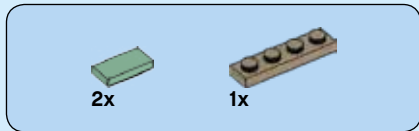

42

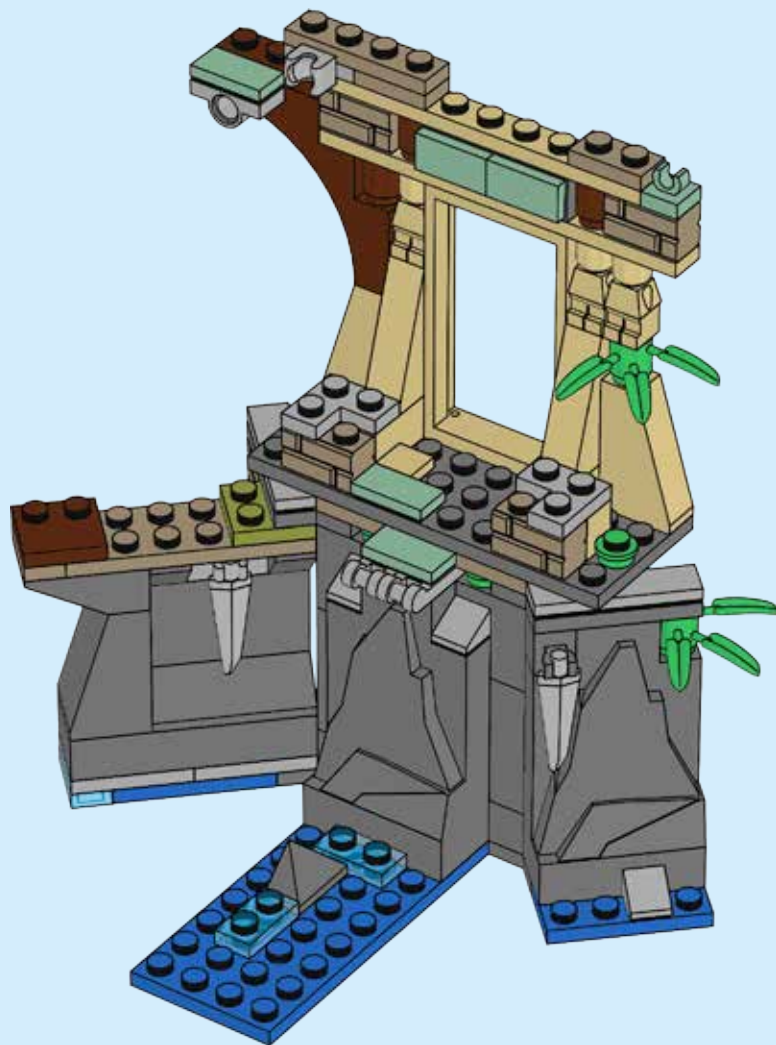

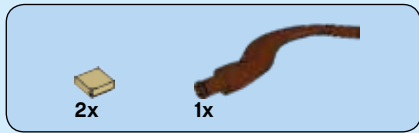

43

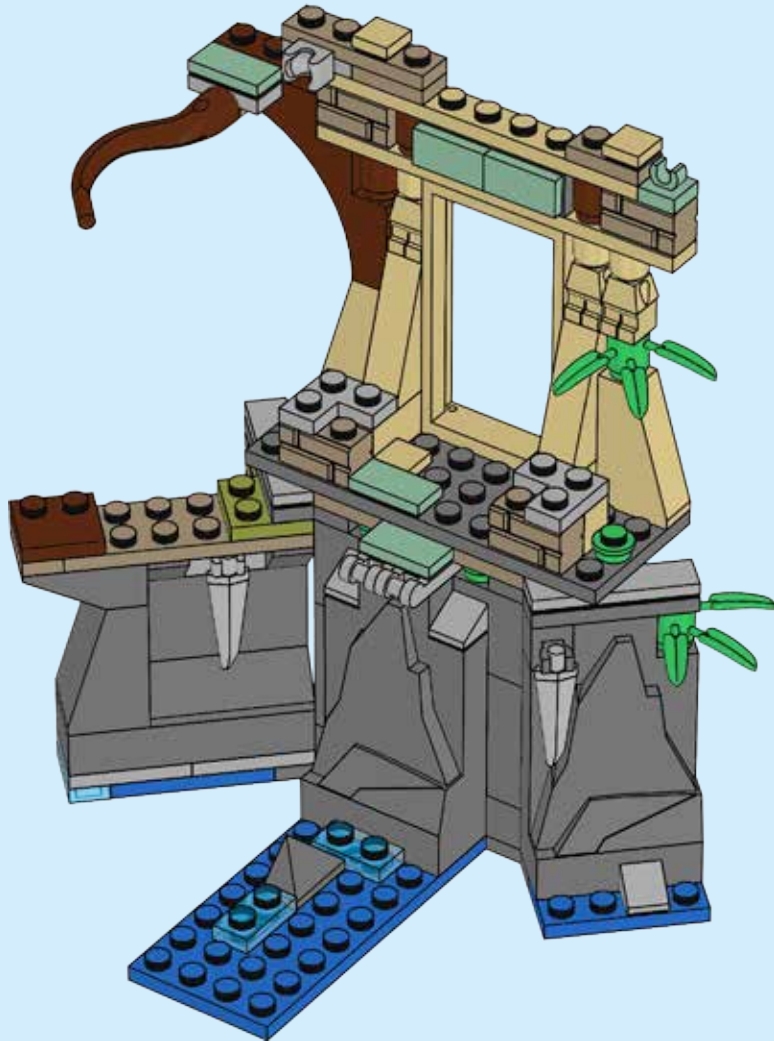



44

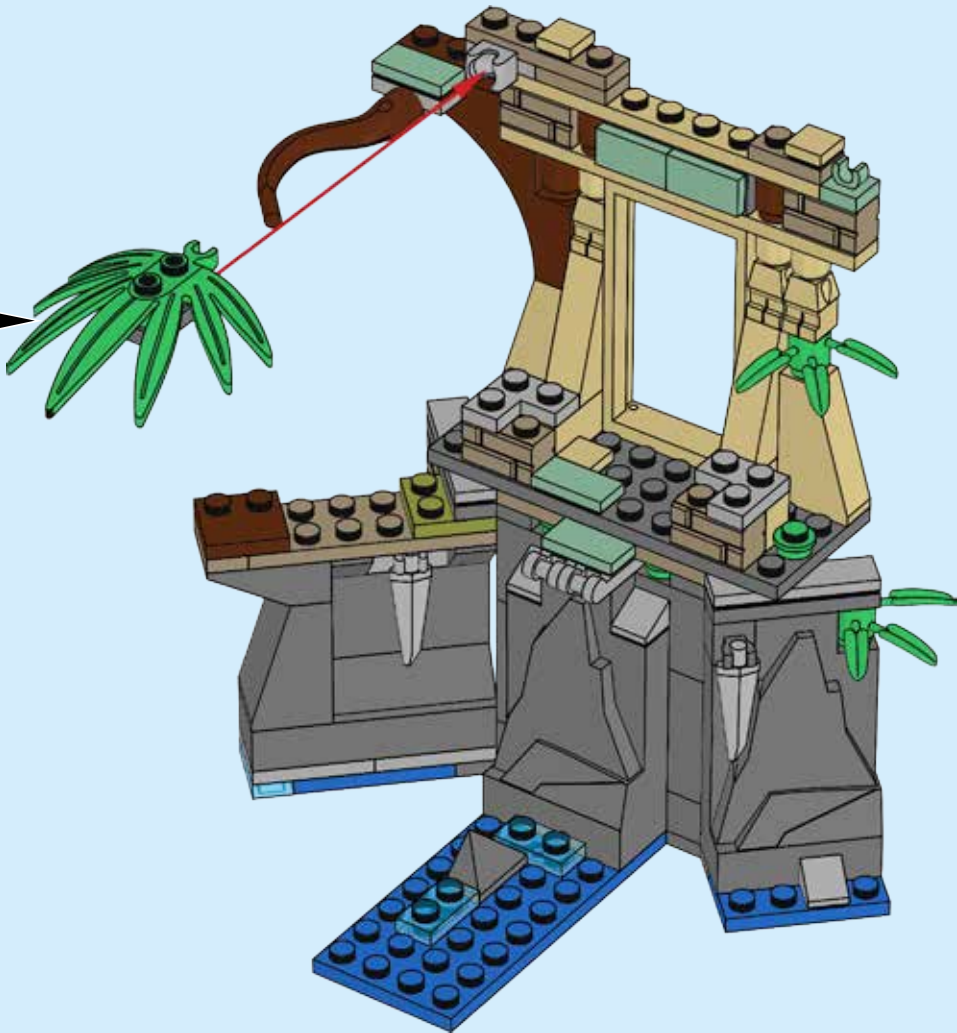

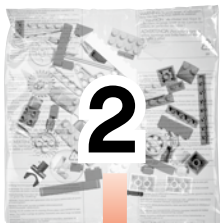

2



45

1x

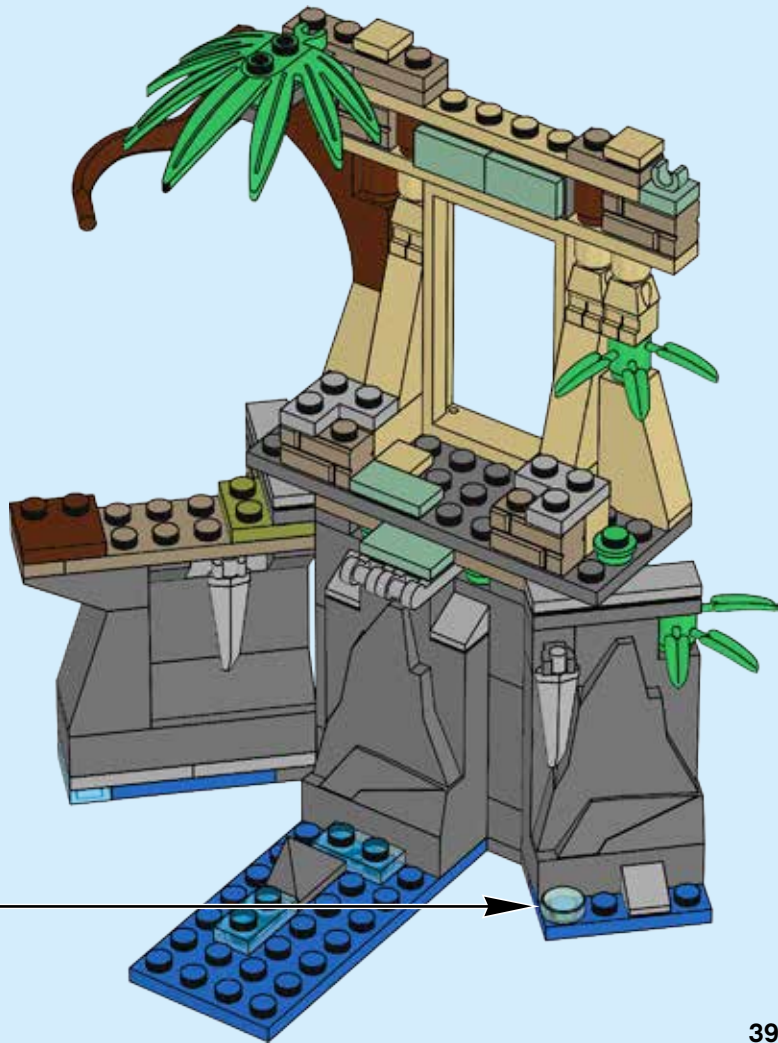

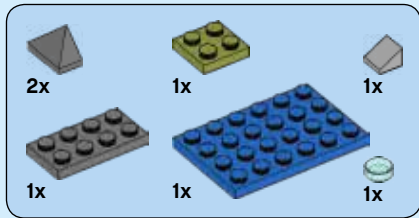

46

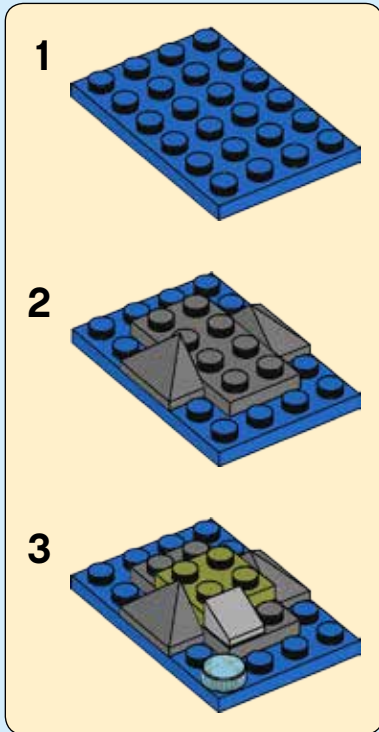



47

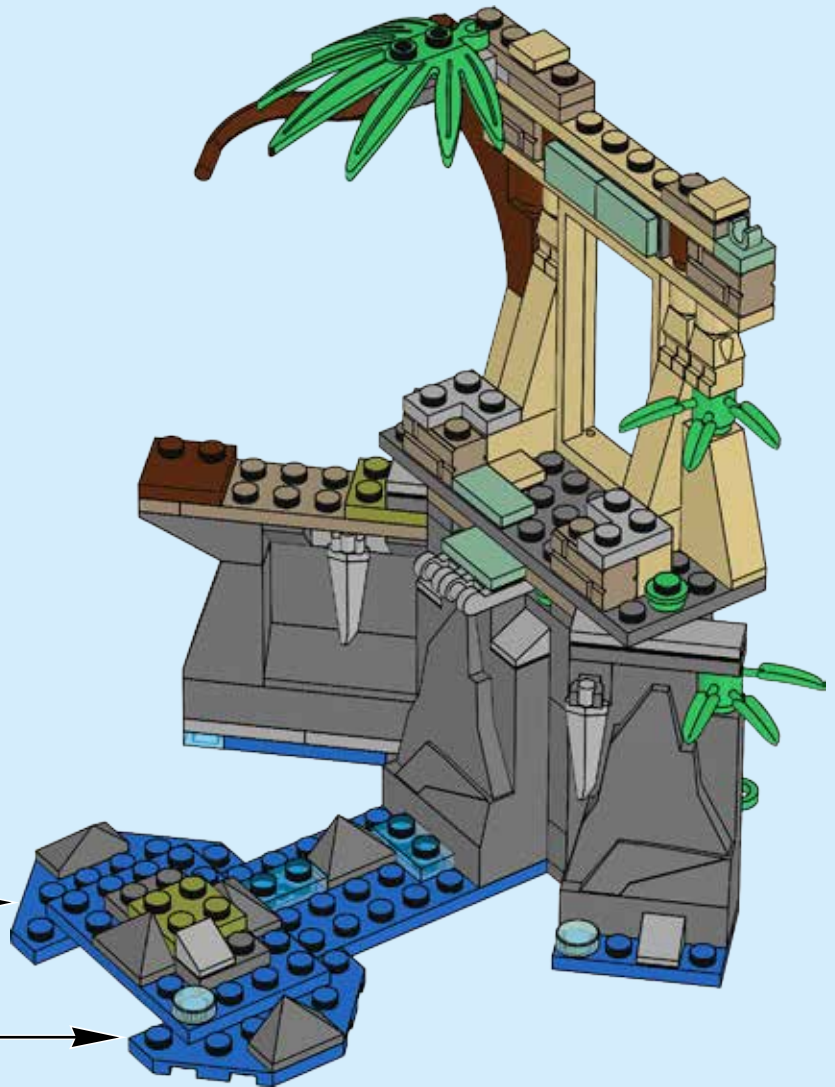
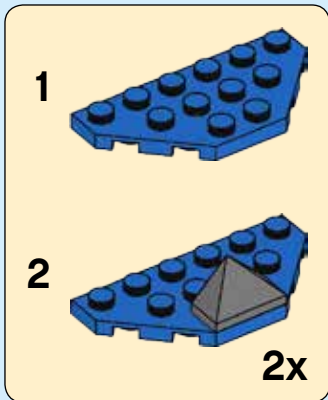

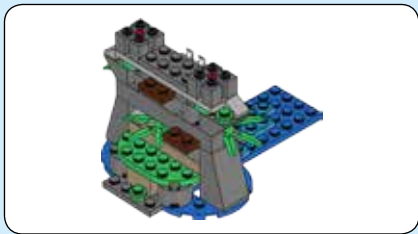

48

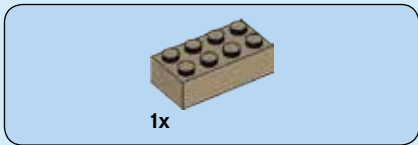

49

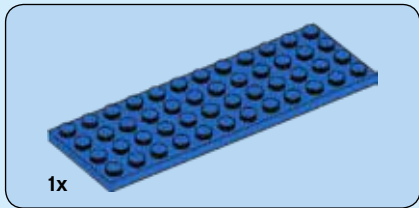
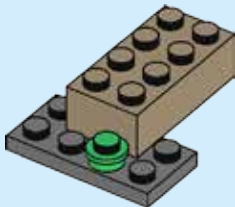

50

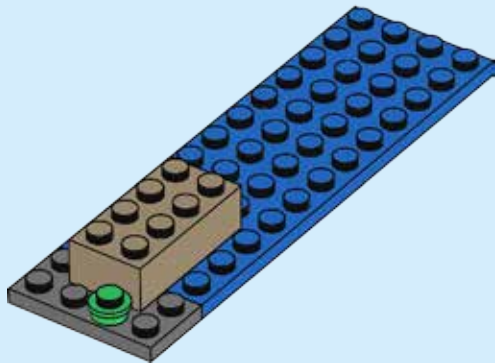



51

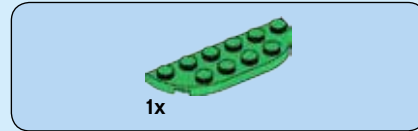
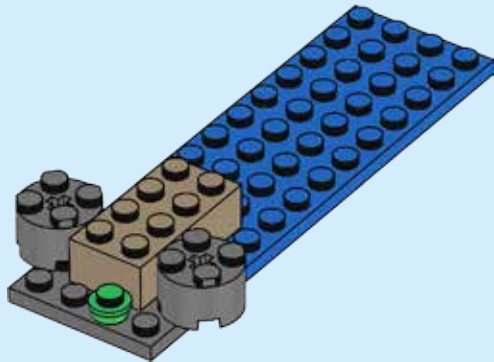

52

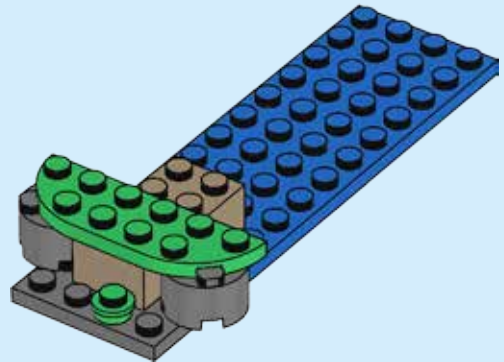



2x

53

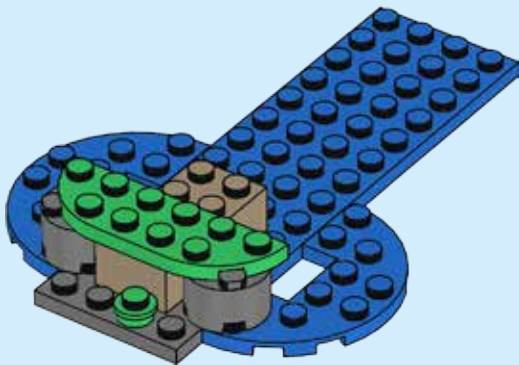

2x

54

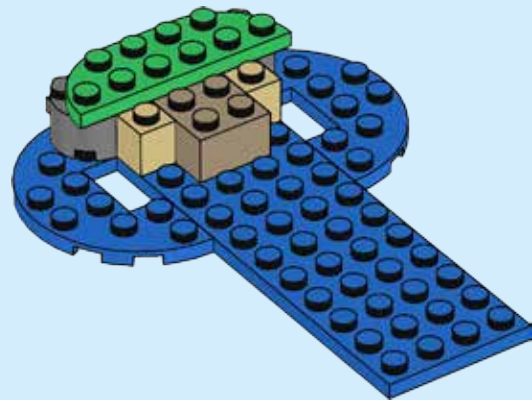
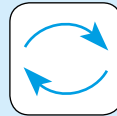

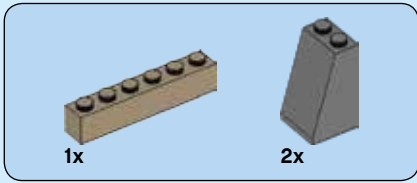

55

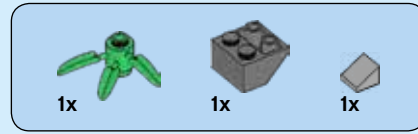
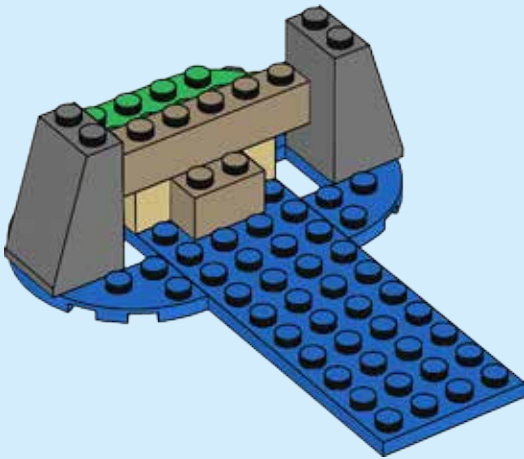

56

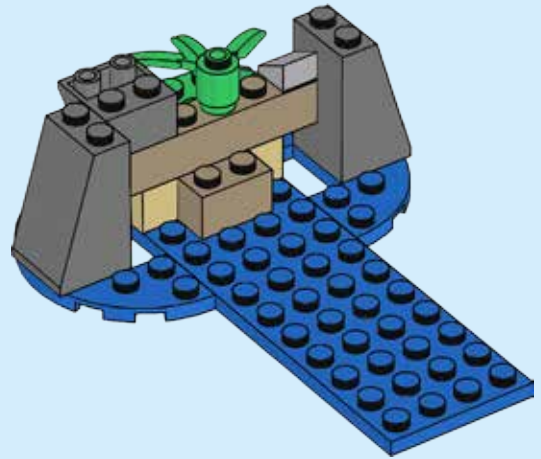



57

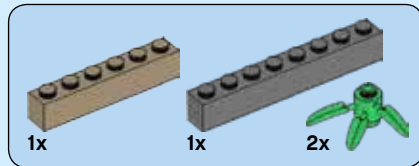
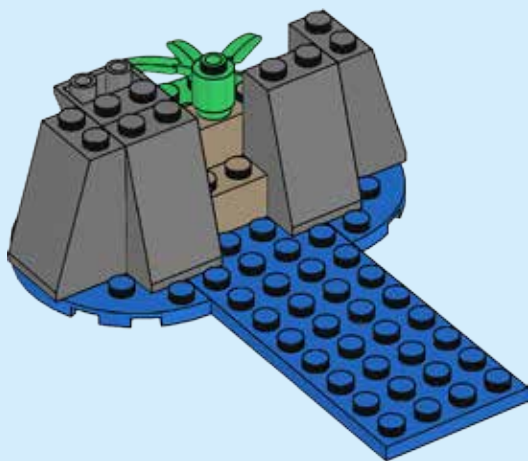

58

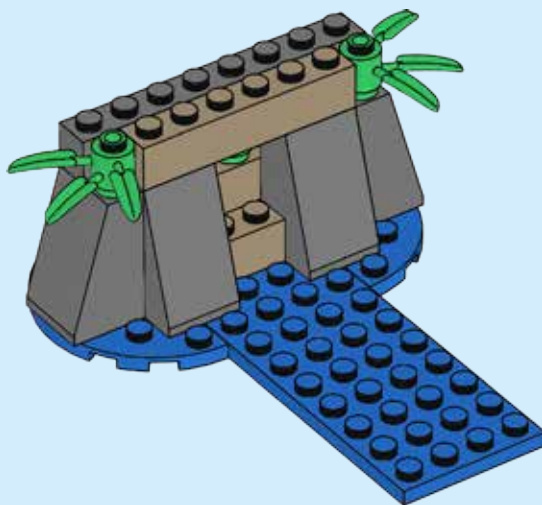



59

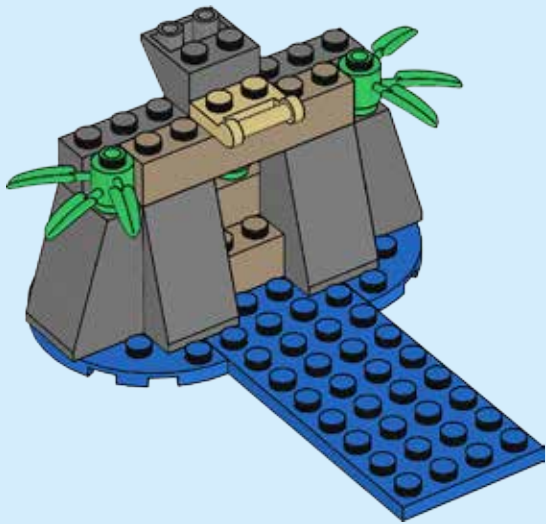

60

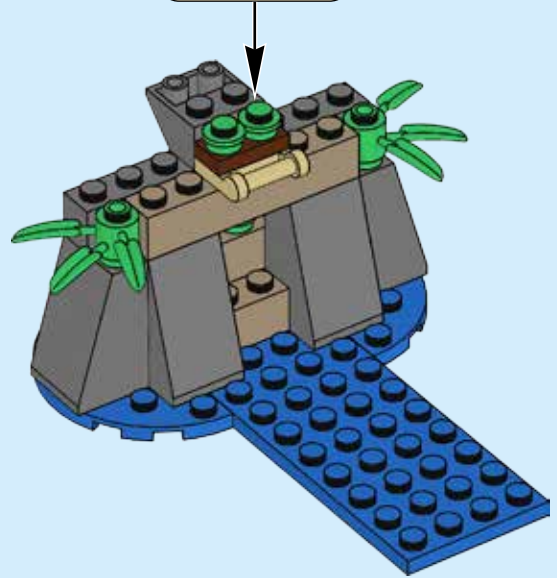



2x



2x

61

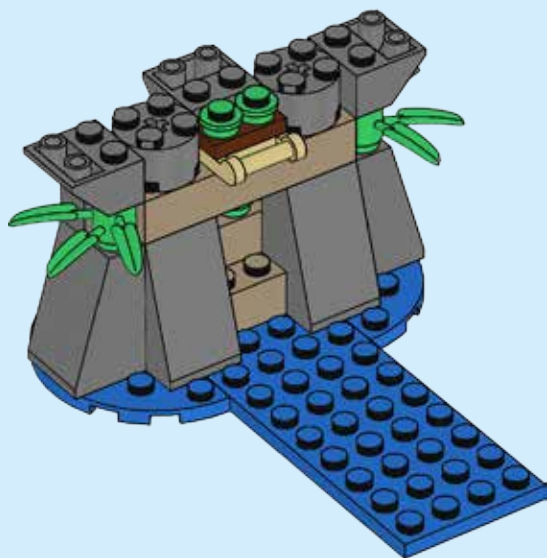

2x



1x

62

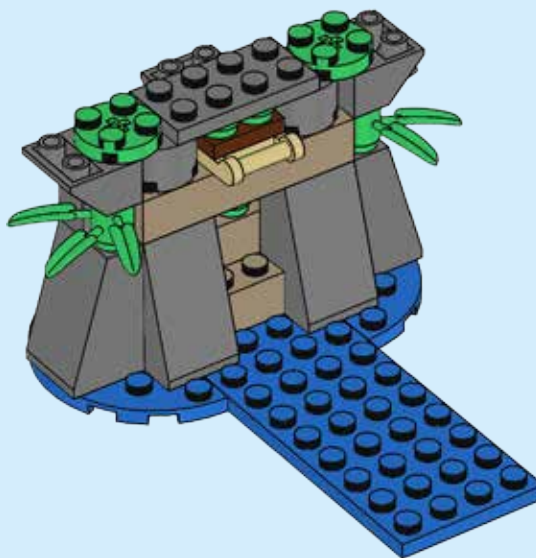

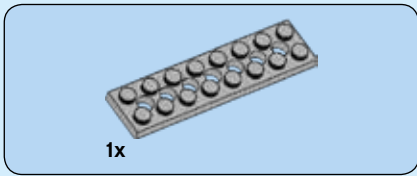

63

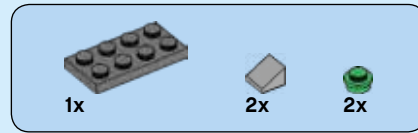
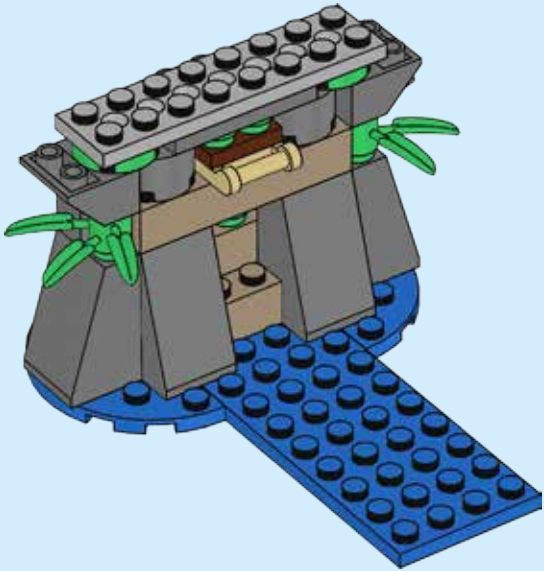

64

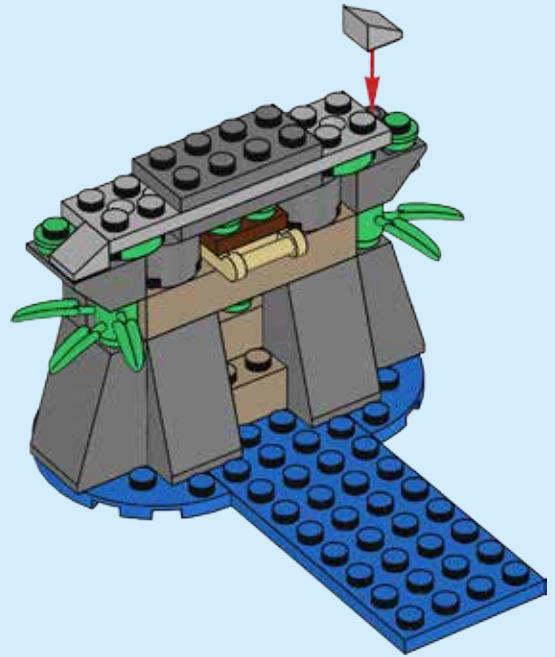



2x

65

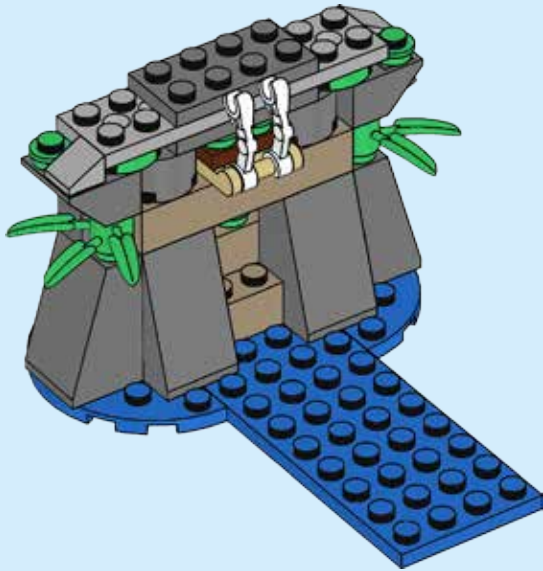

3x



1x

66

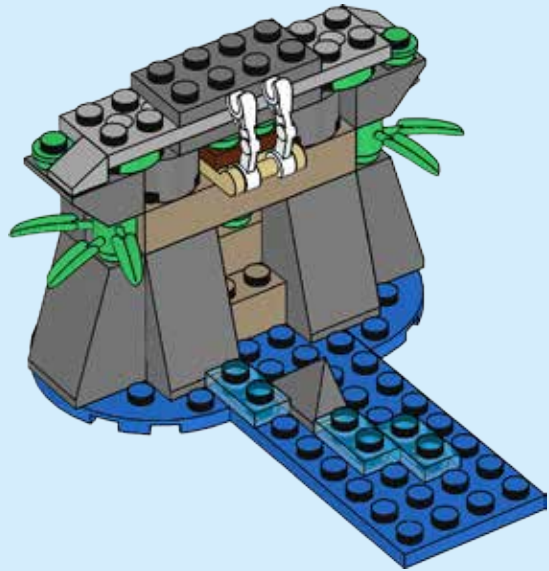



67

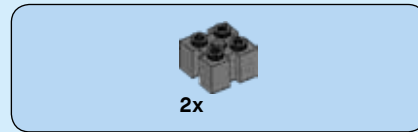
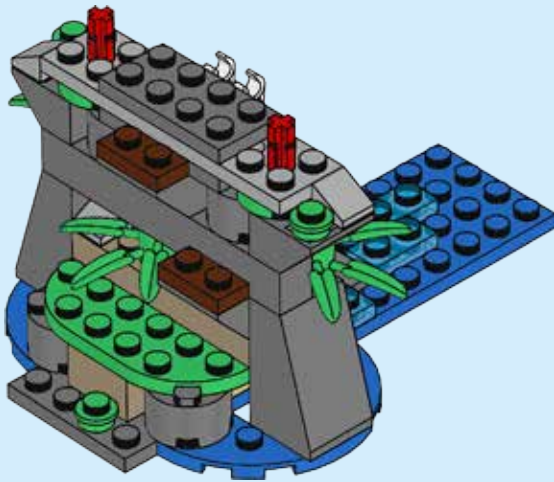
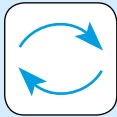

68

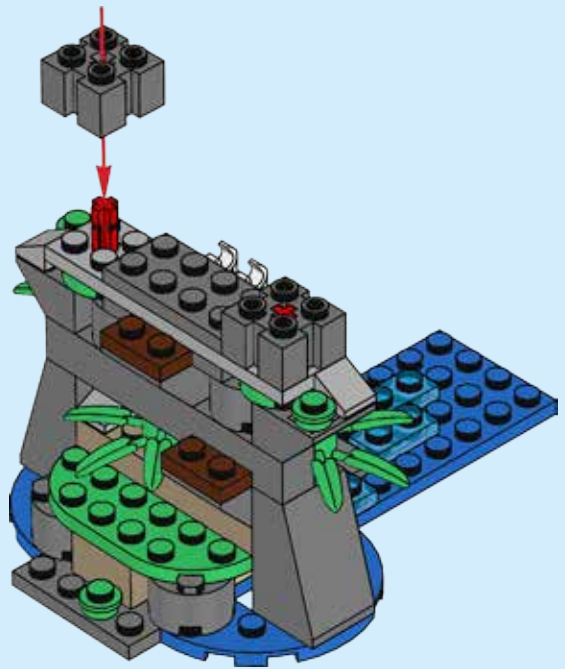

69



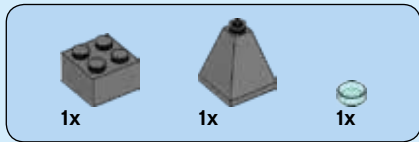

70

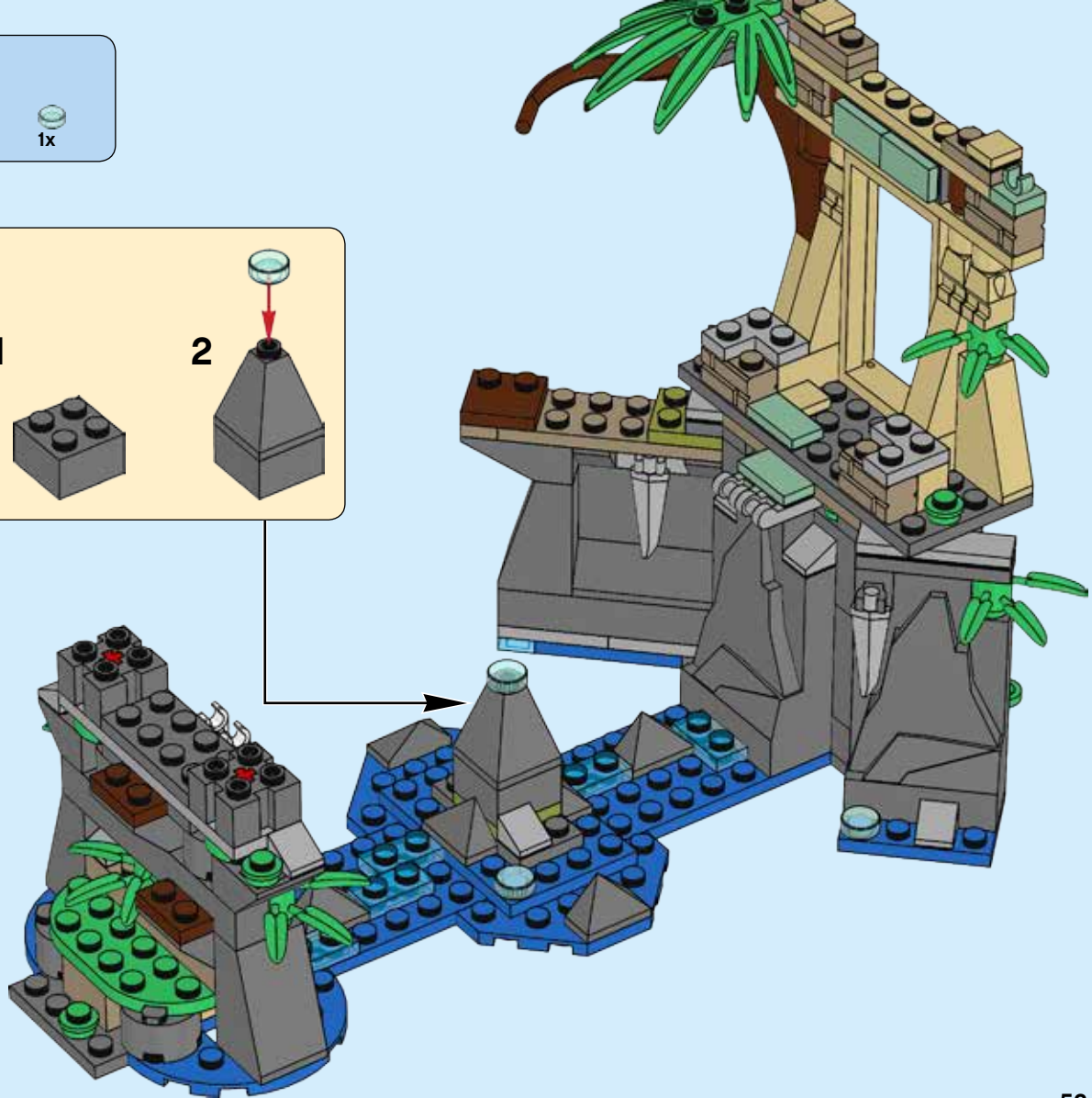
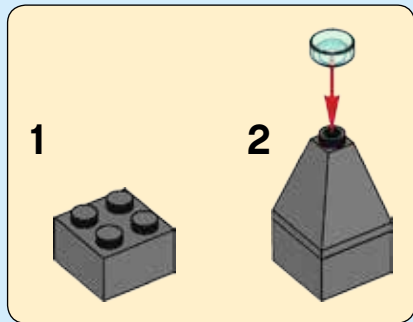

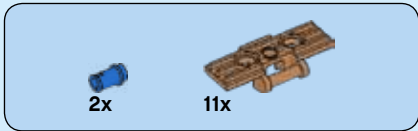

71

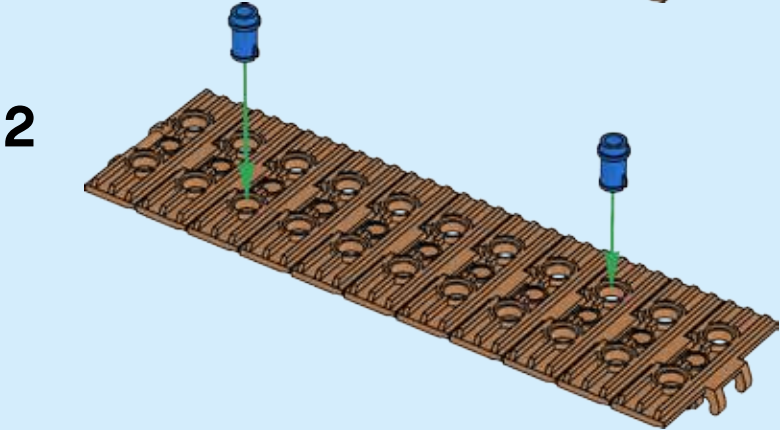
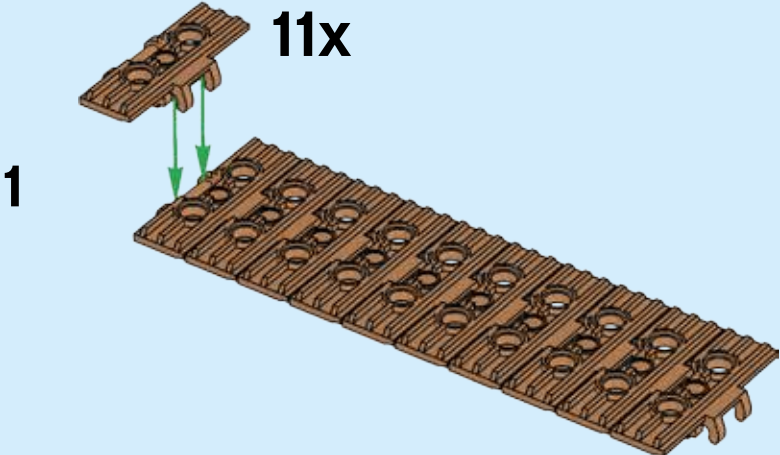

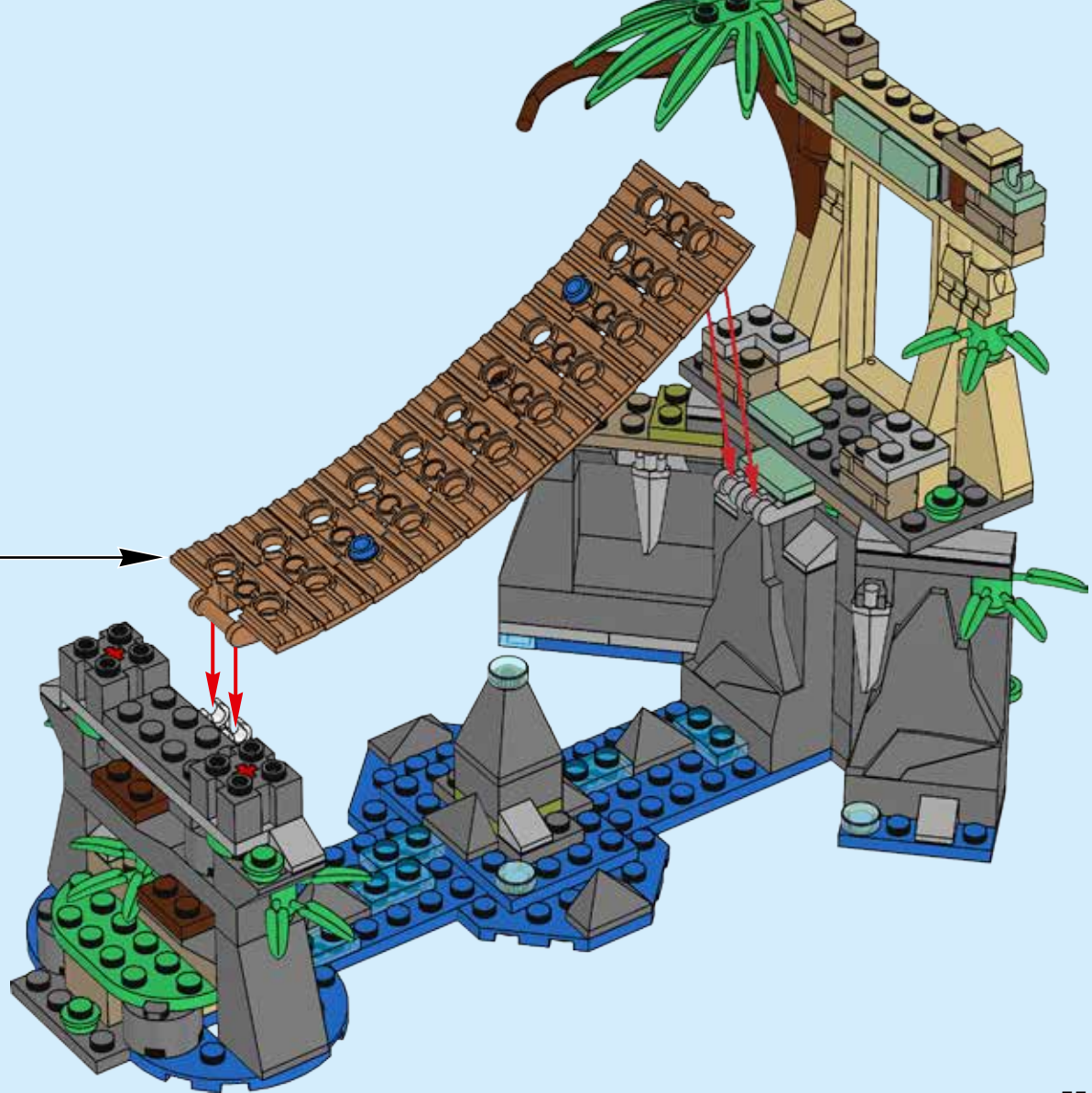



2x



4x

72

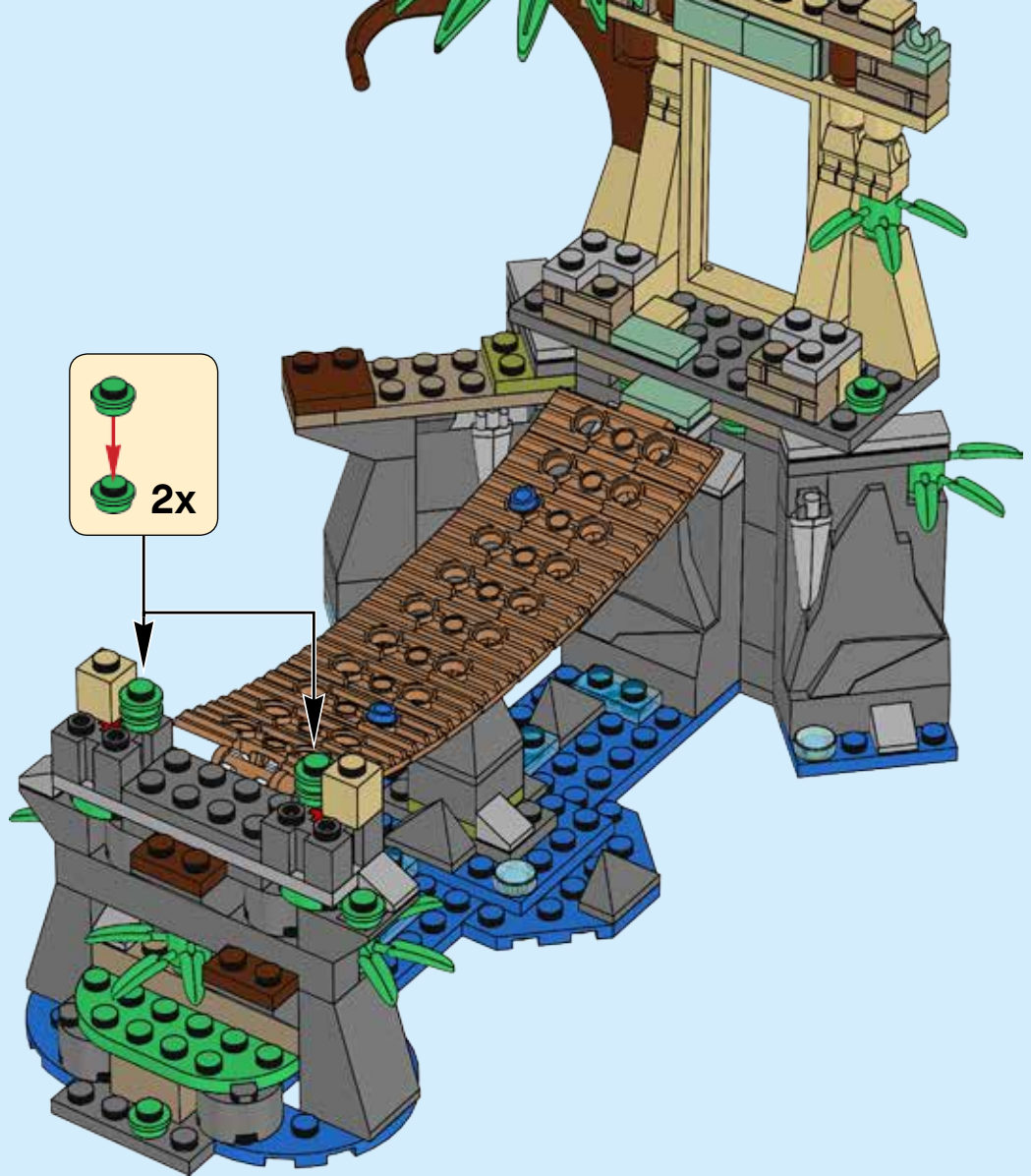
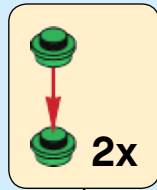



73

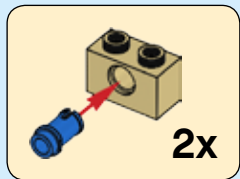

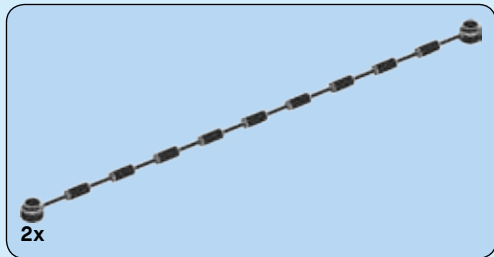

74

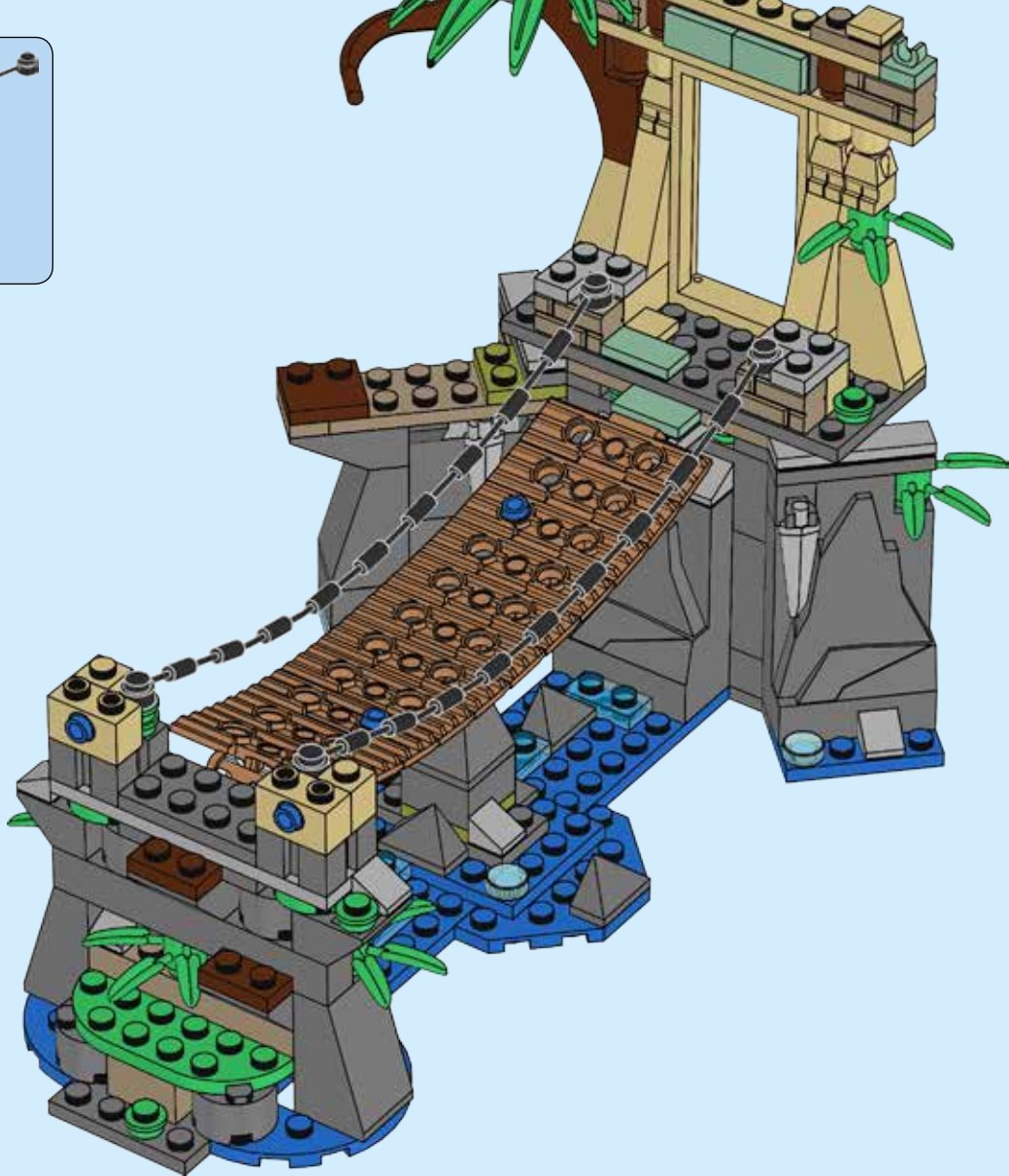

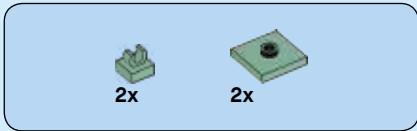

75

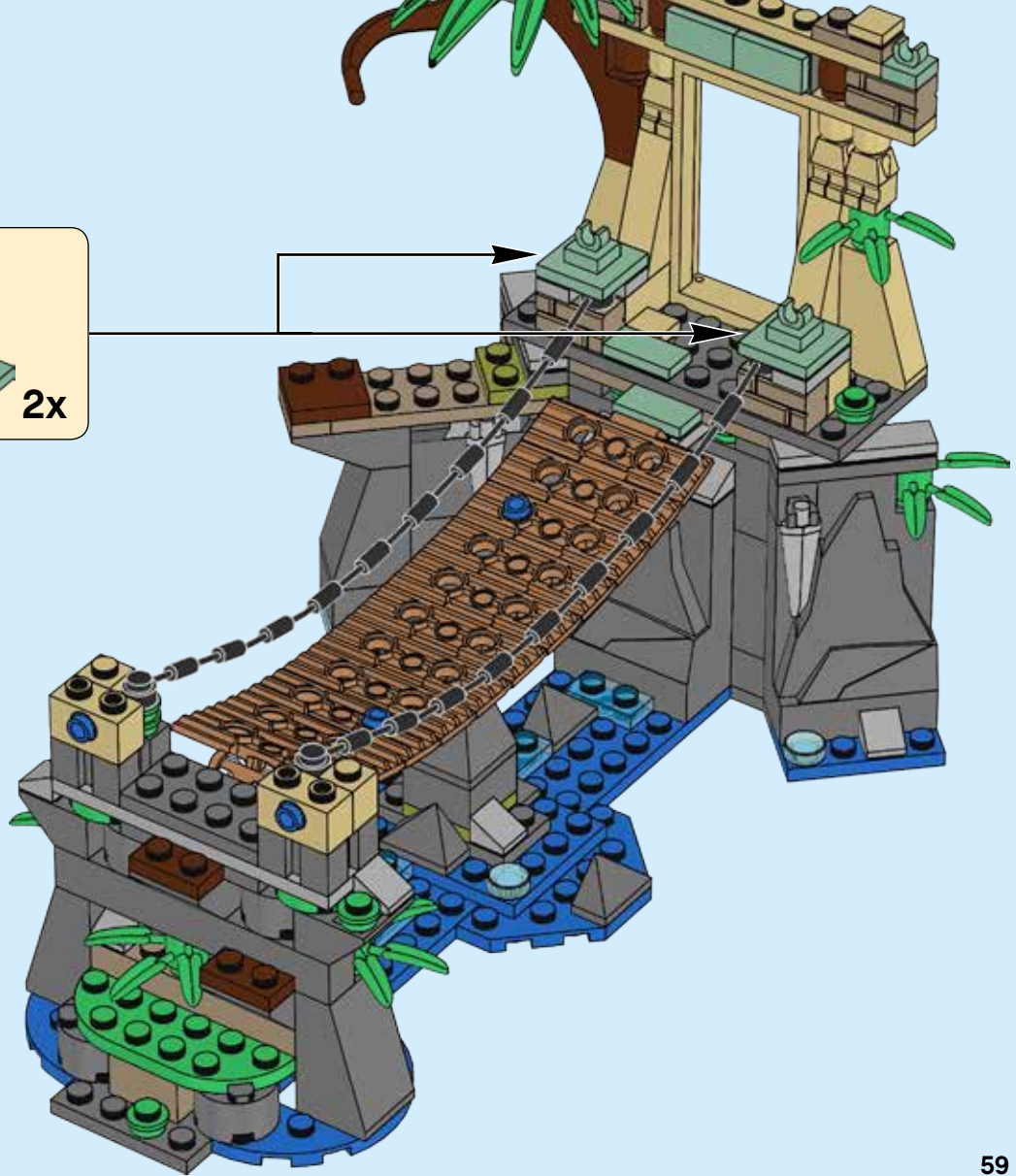
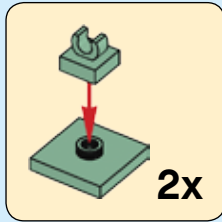



76

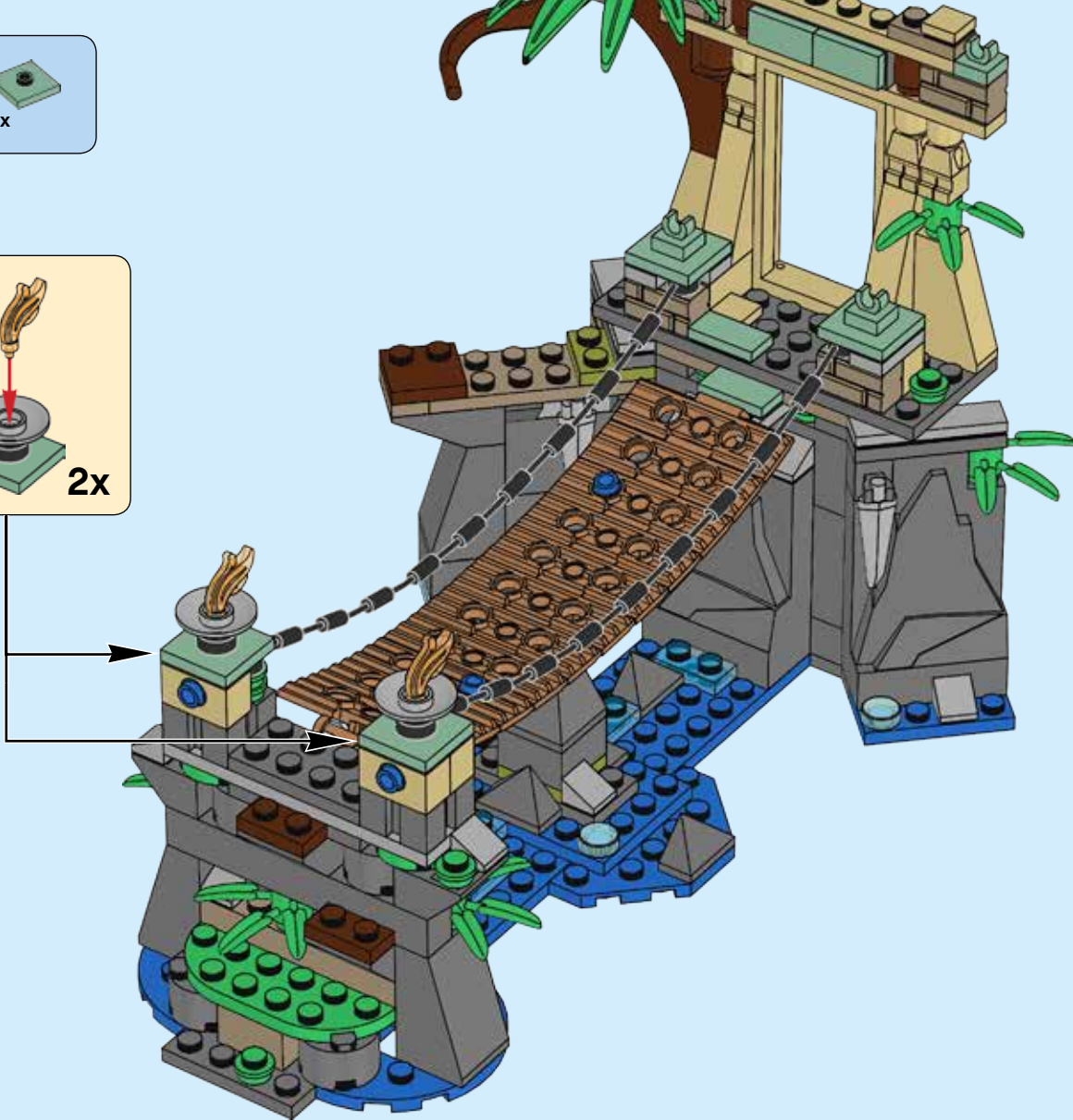
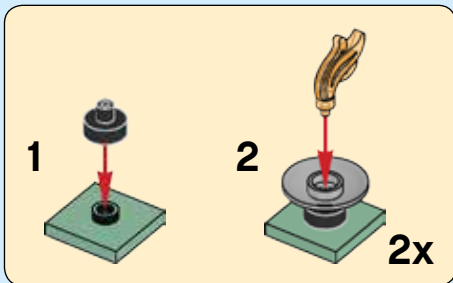



2x

77

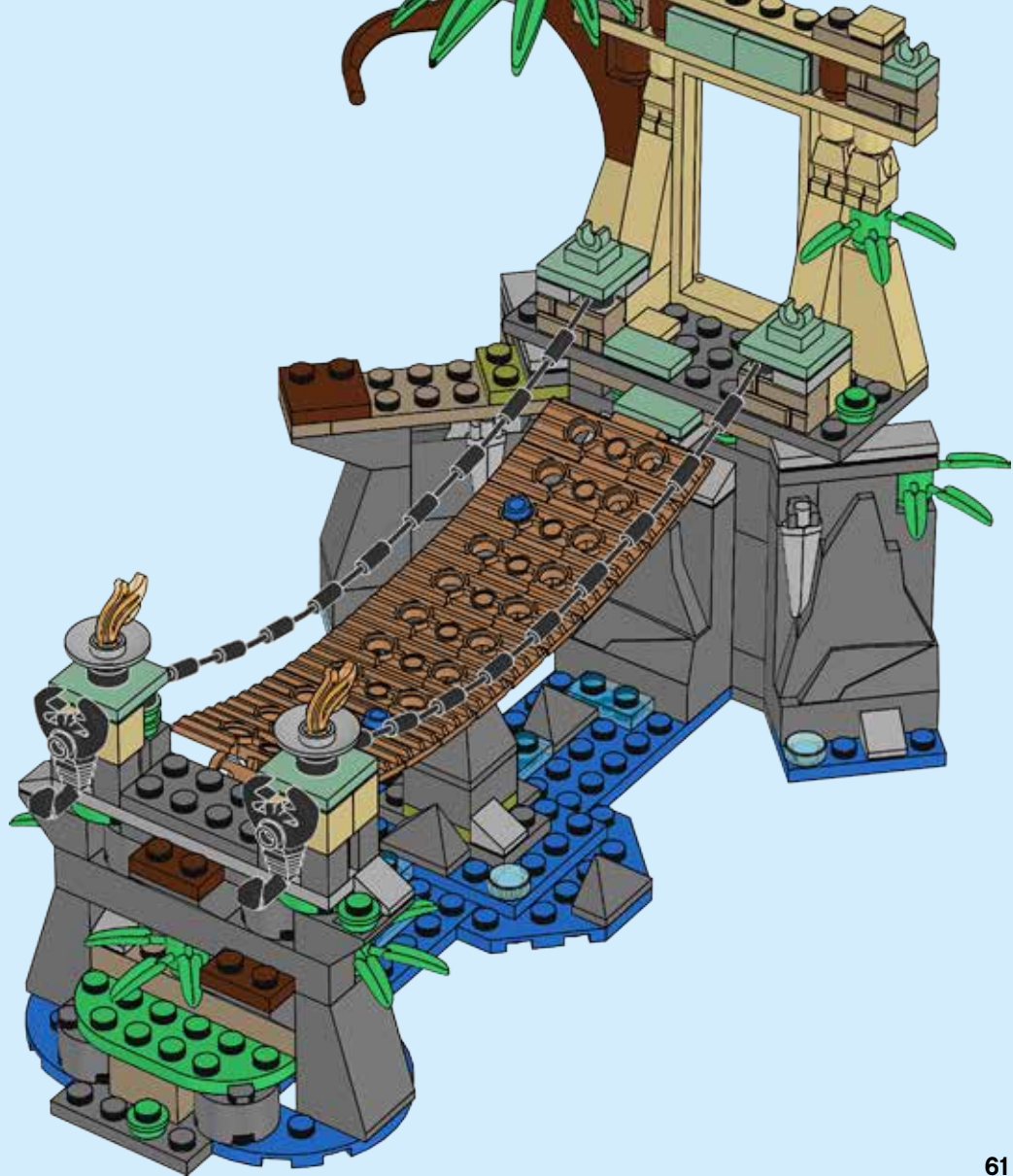



14x



14x

78

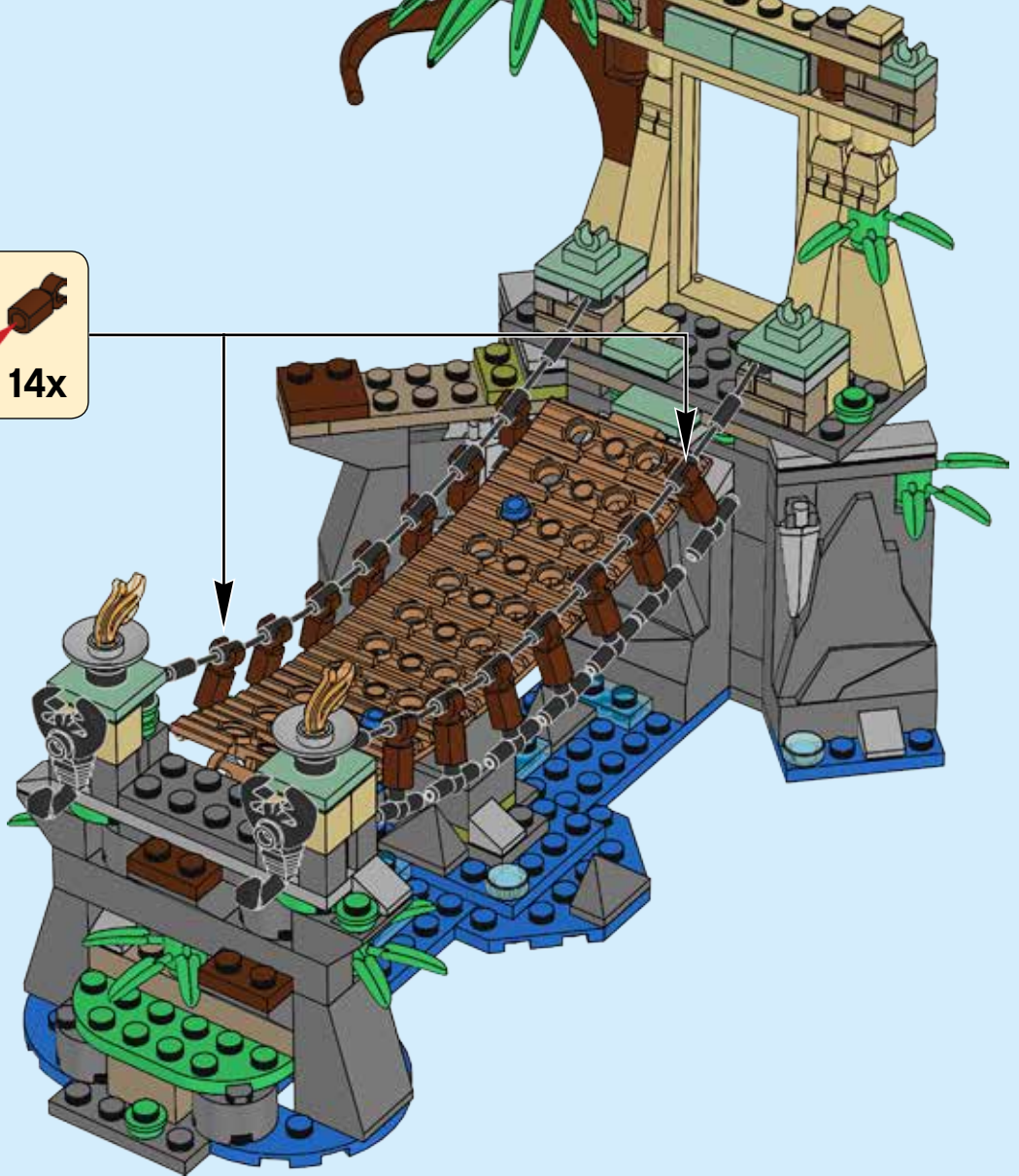
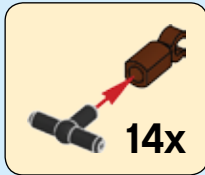

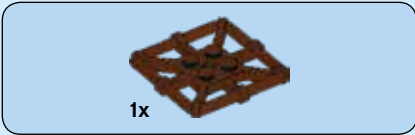

79



80

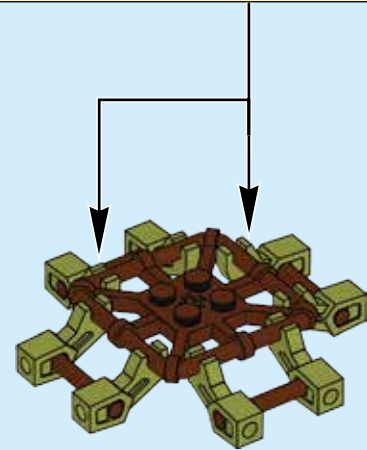
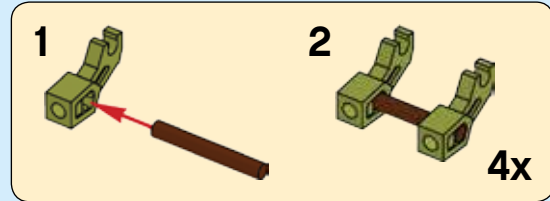

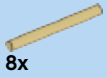

8x

81

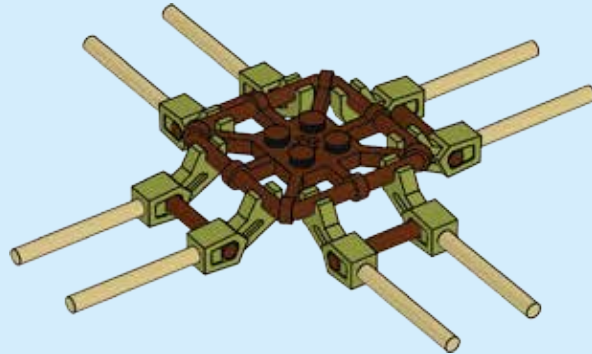

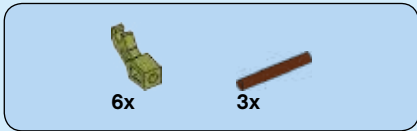

82

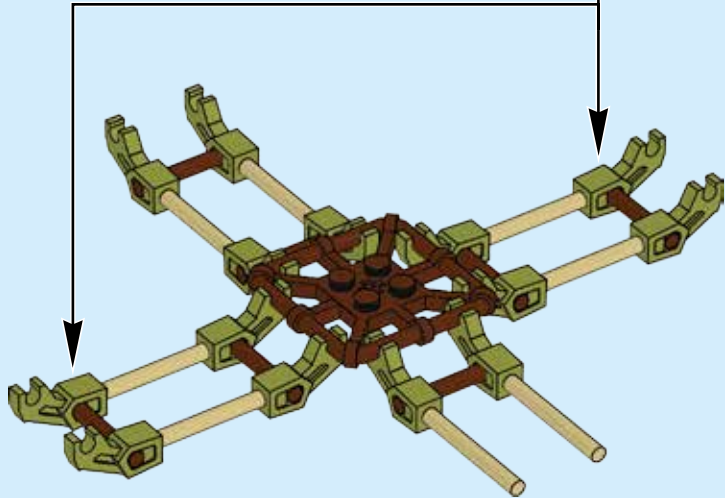
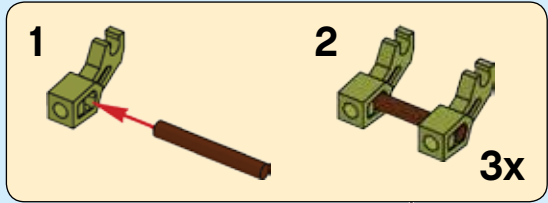

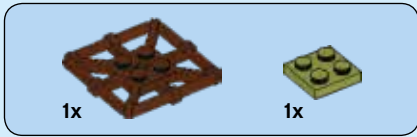

83

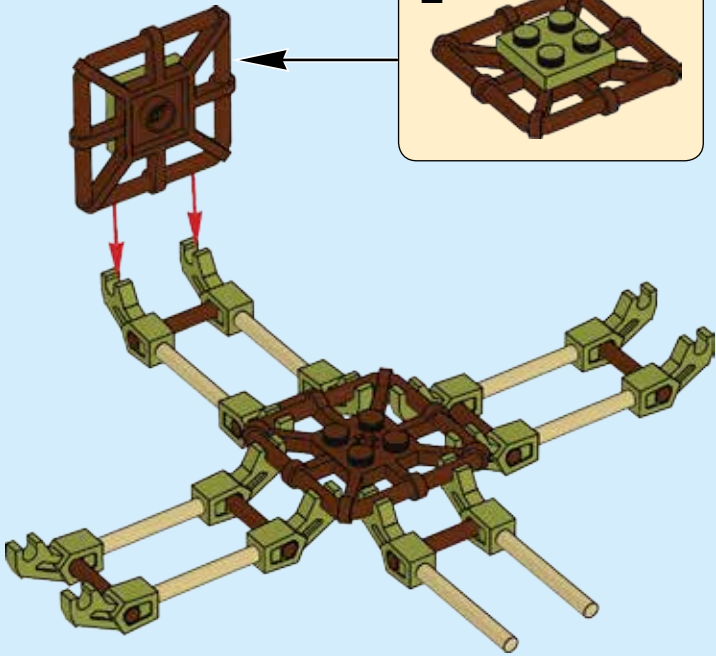
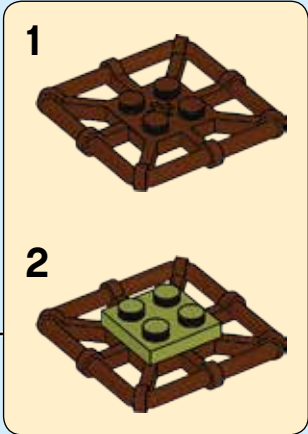

84

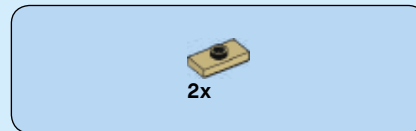
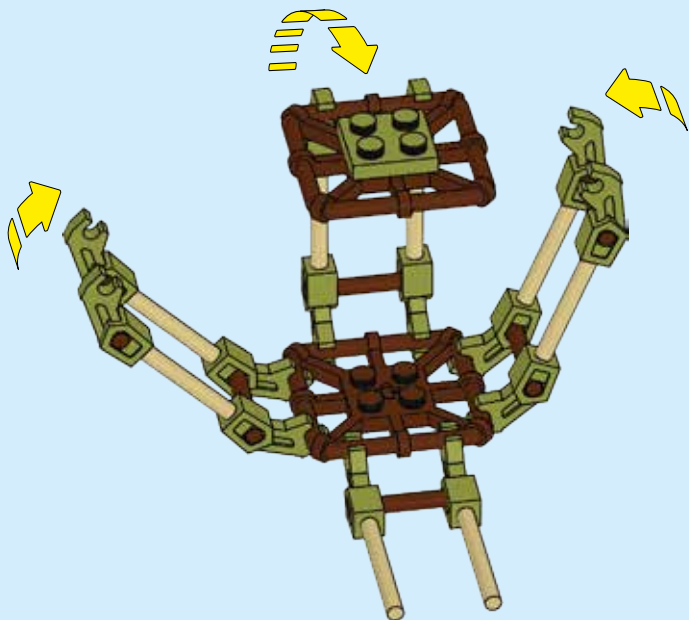

85

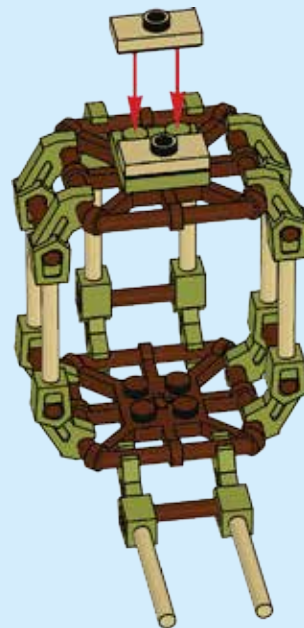



86

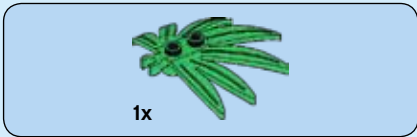

87



88







THE NINJAGO MOVIE



LEGO.COM/NINJAGOMOVIE



THE NINJAGO MOVIE

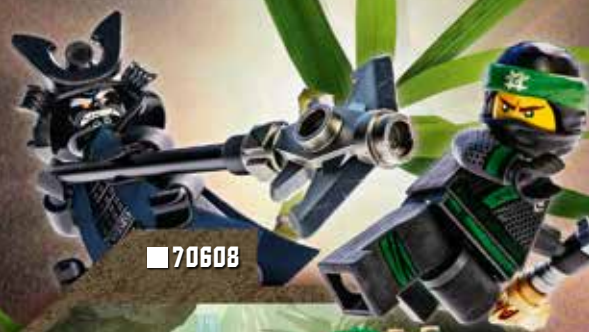

■ 70612



■ 70614



■ 70618



■ 70617



■ 70615





THE NINJAGO MOVIE



LEGO® WU-CRU
LEGO.com/apps



LEGO.COM/NINJAGOMOVIE

AVAILABLE
FALL 2017



DISPONIBLE
AUTOMNE 2017

DISPONIBLE
OTOÑO 2017



THE NINJAGO MOVIE VIDEOGAME



RATING PENDING
COTE EN ATTENTE
RP
ESRB

Visit esrb.org for
rating information
Visiter esrb.org
pour les classifications

LEGO.com/videogames



PS4

PC



XBOX ONE



GAMES



UNLOCK MODEL IN GAME / Separate purchase required
 MODÈLE À DÉVERROUILLER EN JEU / Achat séparé requis
 DESBLOQUEAR MODELO EN EL JUEGO / Se requiere la compra por separado

PPA72V



LEGO.com/worlds



LEGO WORLDS software © 2017 TT Games Ltd. Produced by TT Games under license from the LEGO Group. LEGO, the LEGO logo, the Brick and the Knob configurations and the Minifigure are trademarks of the LEGO Group. © 2017 The LEGO group. All other trademarks and copyrights are the property of their respective owners. All rights reserved. WB GAMES LOGO, WB SHIELD: ™ & © Warner Bros. Entertainment Inc. (s17)

Logiciel LEGO WORLDS © 2017 TT Games Ltd. Produit par TT Games avec l'autorisation du Groupe LEGO. LEGO, le logo LEGO, les configurations de briques et tenons et la minifigurine sont des marques de commerce du Groupe LEGO. © 2017 Le Groupe LEGO. Tous les autres droits d'auteur et marques de commerce sont la propriété de leurs propriétaires respectifs. Tous droits réservés. LOGO WB GAMES, LOGO WBIE, BOUCLIER WB : ™ et © Warner Bros. Entertainment Inc. (s17)

LEGO WORLDS software © 2017 TT Games Ltd. Producido por TT Games bajo licencia de LEGO Group. LEGO, el logotipo de LEGO, la configuración del Ladrillo y de la Perilla, y la Minifigura son marcas comerciales de LEGO Group. © 2017 The LEGO Group. Todas las demás marcas comerciales y derechos de autor son propiedad de sus respectivos propietarios. Todos los derechos reservados. LOGOTIPO DE WB GAMES, LOGOTIPO DE WBIE, ESCUDO DE WB: ™ y © Warner Bros. Entertainment Inc. (s17)

LEGO **NINJAGO**
The Ride



LEGO
LEGOLAND
RESORTS
CALIFORNIA • FLORIDA

EXCLUSIVELY! • EXCLUSIVEMENT ! • ¡EN EXCLUSIVA! • EXCLUSIVELY!

LEGO
LEGOLAND
DISCOVERY CENTER

Arizona • Atlanta • Boston • Chicago
Dallas/Fort Worth • Kansas City
Michigan • Toronto • Westchester



LEGO, the LEGO logo, NINJAGO, the NINJAGO logo, the Minifigure and LEGOLAND are trademarks and/or copyrights of the/son des marques de commerce et/ou copyrights du/son marcas registradas, algunas de ellas protegidas por derechos de autor, de LEGO Group. ©2017 The LEGO Group. LEGOLAND is part of Merlin Entertainments plc.

LEGOLAND.COM

 1x 6192506	 1x 4641682	 9x 4521921	 1x 4217562	 2x 6167933	 2x 4649066
 1x 6190411	 1x 6043656	 2x 4211512	 1x 6199331	 1x 6199539	 6x 6116593
 3x 6022171	 2x 4211353	 2x 6092587	 1x 6172557	 14x 6104209	 1x 6195509
 1x 6195289	 1x 6045988	 2x 4205107	 3x 4585486	 1x 6191586	 4x 4143005
 2x 6038450	 2x 4515369	 4x 4129996	 3x 4125253	 1x 6199542	 2x 302023
 2x 6146060	 4x 4616840	 2x 4162465	 6x 4113915	 2x 4551360	 2x 6133564
 1x 4651445	 2x 4211396	 8x 6116614	 2x 6029889	 1x 6199564	 2x 241923
 1x 4609289	 2x 4211356	 1x 4578110	 1x 6192537	 1x 6191573	 1x 303223
 2x 4260649	 1x 4560183	 1x 4578110	 3x 6125669	 1x 6199538	 2x 4528850
 1x 4508143	 1x 4560183	 6x 4616578	 6x 4616578	 2x 6096958	 11x 6097524
 1x 6192727	 1x 4211449	 2x 4143409	 4x 6186826		

16x
6080355

3x
4211183

3x
4211150

8x
6075208

1x
6196221

1x
4211152

1x
6044725

1x
6081990

2x
6022098

1x
6133318

14x
6014296

3x
6079617

1x
6198114

2x
4142865

1x
4580437

6x
6076203

4x
4249139

2x
4211096

1x
6123814

2x
4583879

4x
4211000

2x
4210978

1x
4211075

5x
6000853

1x
4645099

1x
4211060

1x
4211064

1x
4210725

2x
4551044

3x
4211127

4x
4211065

2x
4513326

4x
6133811

2x
6106191

1x
4210875

1x
4211099

1x
4211122

12x
4569058

2x
403228

5x
4114348

1x
6055462

1x
6133852

2x
6097473

1x
6194388

1x
6198018

6x
4260426

5x
4646577

4x
4528604

2x
4626904

1x
4247145

2x
4247151

3x
4550329

Customer Service

Kundenservice

Service Consommateurs

Servicio Al Consumidor

LEGO.com/service or dial

 : 00800 5346 5555
: 1-800-422-5346

WIN

GO TO WWW.LEGO.COM/PRODUCTFEEDBACK AND
GIVE US YOUR SHORT **FEEDBACK** ABOUT THIS
LEGO® SET FOR A CHANCE TO WIN
A COOL LEGO PRIZE.

Terms & Conditions apply



LEGO.com/productfeedback

GEWINNE

Erzähle uns auf
www.LEGO.com/productfeedback

etwas über die Erfahrungen, die du mit
diesem LEGO® Set gemacht hast, und
sichere dir die Chance auf einen coolen
LEGO Preis!

Es gelten die Teilnahmebedingungen

GAGNE

Rends-toi sur
www.LEGO.com/productfeedback

et donne-nous quelques commentaires
sur ce produit LEGO® pour avoir une
chance de gagner un prix LEGO !

Voir Conditions Générales

GANANA

Visita
www.LEGO.com/productfeedback

y envíanos tu opinión acerca de este set
LEGO®. ¡Participarás en el sorteo de un
premio LEGO!

Términos y Condiciones aplicables

获取奖品

登录
www.LEGO.com/productfeedback

给出关于此乐高®套装的简短反馈，
就有机会获得炫酷乐高奖品

《条款及条件》适用

THE LEGO NINJAGO MOVIE © & ™ Warner Bros. Entertainment Inc. & The LEGO Group. LEGO, the LEGO logo, NINJAGO and the Brick and Knob configurations are trademarks of the/son des marques de commerce du/son marcas registradas de LEGO Group. ©2017 The LEGO Group. All rights reserved/Tous droits réservés/Todos los derechos reservados. (s17)

6215076