



DIMENSIONS™

71264



PLAY THE COMPLETE MOVIE



LEGO.com/DIMENSIONS

LEGO DIMENSIONS Videogame software © 2017 TT Games Ltd. Produced by TT Games under license from the LEGO Group. LEGO, the LEGO logo, NINJAGO, the DIMENSIONS logo, the Brick and Knob configurations and the Minifigure are trademarks and/or copyrights of the LEGO Group. ©2017 The LEGO Group. Ghostbusters™ & © 2017 CPH. All Rights Reserved. A-Team™ & © 2017 Twentieth Century Fox Film Corporation. All Rights Reserved. ADVENTURE TIME and all related characters and elements are trademarks of and © Cartoon Network. (s17). TM, ® & ©2017 Paramount Pictures. All Rights Reserved. ©2017 Warner Bros Entertainment Inc. All Rights Reserved. Harry Potter and Fantastic Beasts Publishing Rights © JKR. (s17). © SEGA. All rights reserved. GREMLINS © &™ WBIEI (s17).™ & © Universal Studios. E.T. THE EXTRA TERRESTRIAL is a trademark and copyright of Universal Studios. Licensed by Universal Studios Licensing LLC. All DC characters and related indicia™ & © DC Comics.™ & © WBIEI. (s17). All other trademarks and copyrights are the property of their respective owners. All rights reserved.



WB GAMES LOGO, WBIE LOGO, WB SHIELD:™ & © Warner Bros. Entertainment Inc.
(s17)



All DC characters and related indicia™ & © DC Comics.™ & © WBIEI.
(s17)

© New Line.™ & © SZC lic. to WBIEI.
(s17)

THE LEGO MOVIE © The LEGO Group & WBIEI.

Play the complete movie
Spiele den ganzen Film
Revivez toute l'histoire du film
Spil hele filmen
Speel de volledige film
Juega niveles basados en la película
Rivivi l'intero film



- EN Protect the environment by not disposing of this product with your household waste (2012/19/EU).
Check with your local authority for recycling advice and facilities.
- DE Schützen Sie die Umwelt und entsorgen Sie dieses Produkt nicht mit Ihrem Hausmüll (2012/19/EU).
Informationen zu Recycling-Möglichkeiten erhalten Sie bei den örtlichen Behörden.
- FR Protégez l'environnement : ne jetez pas ce produit avec vos autres déchets ménagers (Directive européenne 2012/19/UE).
Contactez les autorités locales pour obtenir des informations sur le recyclage et connaître les points de collecte.
- IT Proteggi l'ambiente! Non smaltire questo prodotto con i rifiuti domestici (2012/19/UE).
Per consulenza sul riciclaggio dei rifiuti e le strutture di riciclaggio, rivolgersi alle proprie autorità locali.
- NL Bescherm het milieu: gooi dit product niet samen met het andere huisvuil weg (2012/19/EU).
Raadpleeg de plaatselijke instanties voor locaties van milieustations en advies over hergebruik.
- ES Proteja el medio ambiente no deshaciéndose de este producto junto con sus residuos domésticos (2012/19/UE).
Solicite a su autoridad local consejos e información sobre instalaciones de reciclado.
- DA Beskyt miljøet! Smid ikke dette produkt ud sammen med husholdningsaffaldet (2012/19/EU).
Få vejledning om genbrug og genbrugsstationer hos din kommune.
- FI Tämä tuote on hävitettävä ympäristönsuojelun vuoksi asianmukaisesti talousjätteistä erillään (2012/19/EU).
Tietoja keräyspisteiden sijainnista saa kunnan tai kaupungin teknisestä virastosta.
- SV Skydda miljön genom att inte kasta denna produkt bland ditt hushållsavfall (2012/19/EU).
Kontakta din kommun för frågor om återvinning och miljöstationer.
- NO Beskytt miljøet. Ikke kast dette produktet i husholdningsavfallet (2012/19/EU).
Kontakt kommunen for veiledning om gjenbruk og miljøstasjoner.



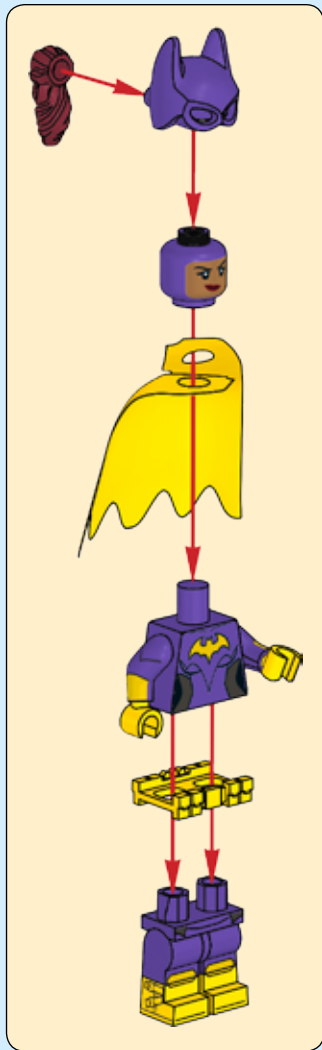
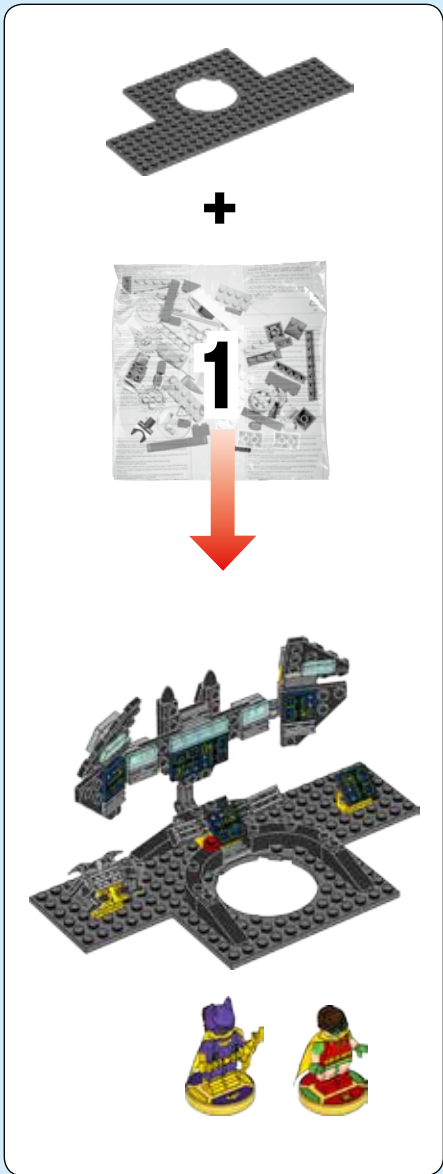

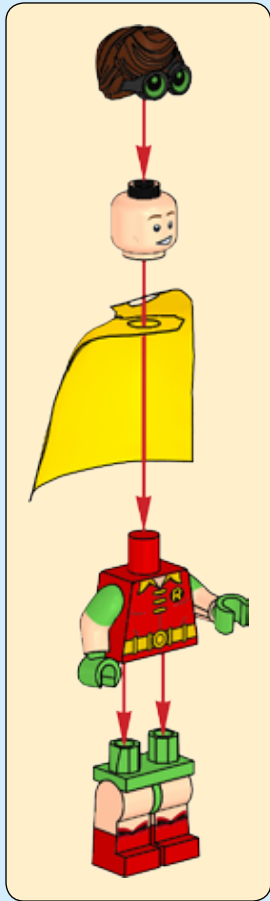



Download the latest game content to use this character

- Lade dir die neusten Spielinhalte herunter, um diese Figur zu benutzen
- Télécharge le contenu le plus récent du jeu pour utiliser ce personnage
- Download det nyeste spilindhold for at bruge denne figur
- Download de nieuwste game-inhoud om deze figuur te kunnen gebruiken
- Ladda ner det senaste spelinnehållet för att använda den här karaktären
- Last ned det nyeste spillinnholdet for å ta i bruk denne figuren
- Pääset käyttämään tätä hahmoa lataamalla pelin uusimman sisällön
- Descarga la última actualización de contenido para usar este personaje
- Scarica gli ultimi contenuti del gioco per usare questo personaggio

Start game
Spiel starten
Commencer à jouer

Start spillet
Game starten
Starta spelet

Aloita peli
Iniciar juego
Avvia il gioco

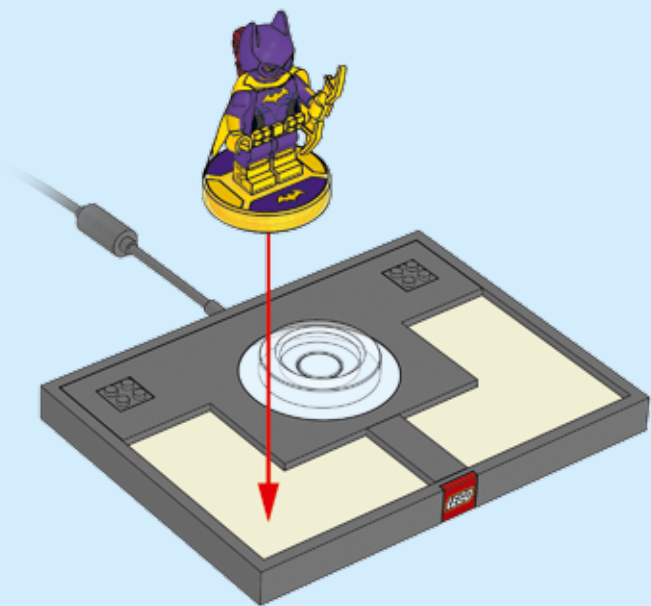



- Building is part of playing the game
- Das Bauen ist Teil des Spiels
- La construction fait partie du jeu
- Byggeri er en del af spillet
- Bouwen is een onderdeel van het spel
- Byggandet är en del av spelet
- Byggingen er en del av spillet
- Peliin kuuluu myös rakennustehtäviä
- Construir forma parte del juego
- La costruzione fa parte del gioco



1x



1x

1

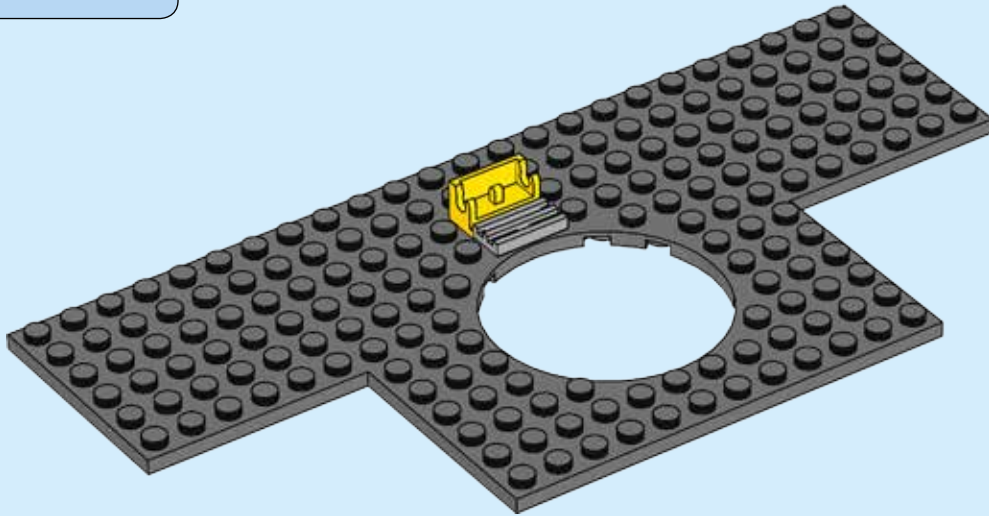

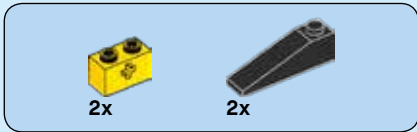

2

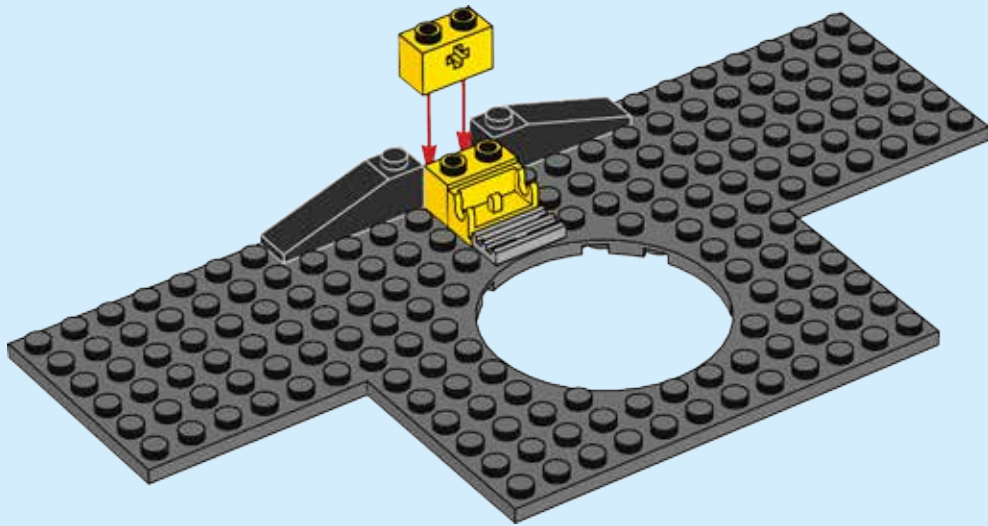

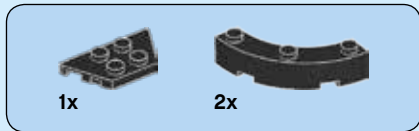

3

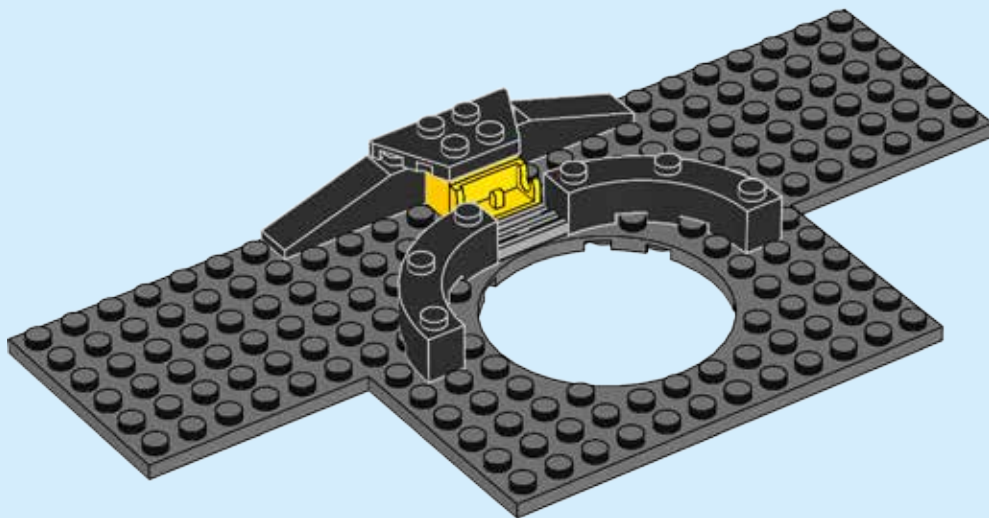

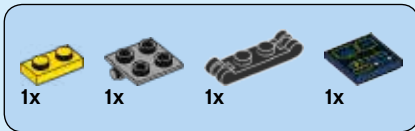

4

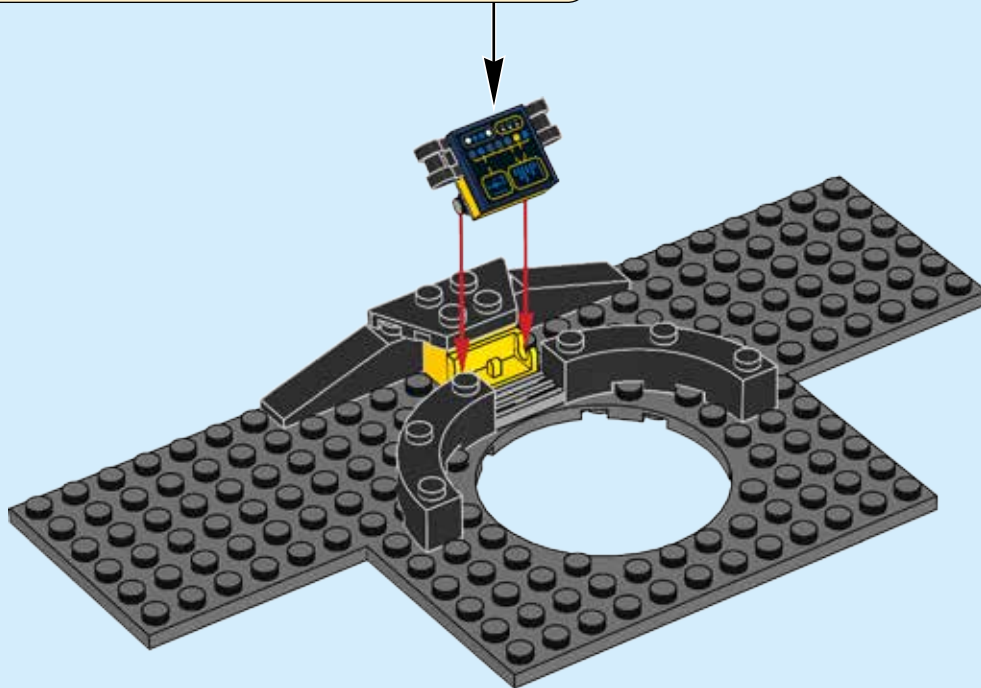



2x



2x

5

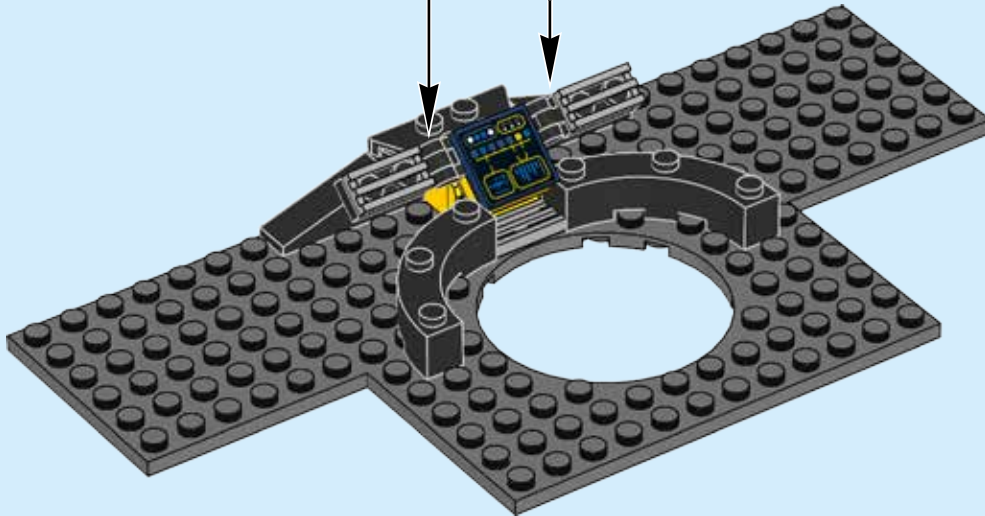
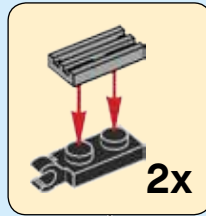

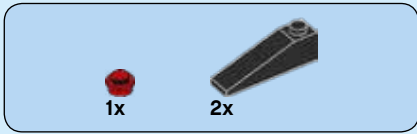

6

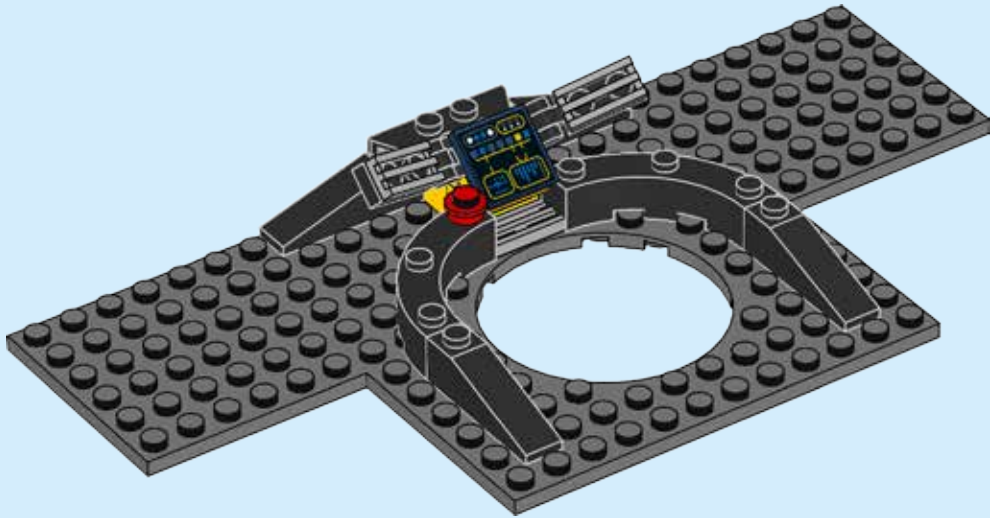



2x

7

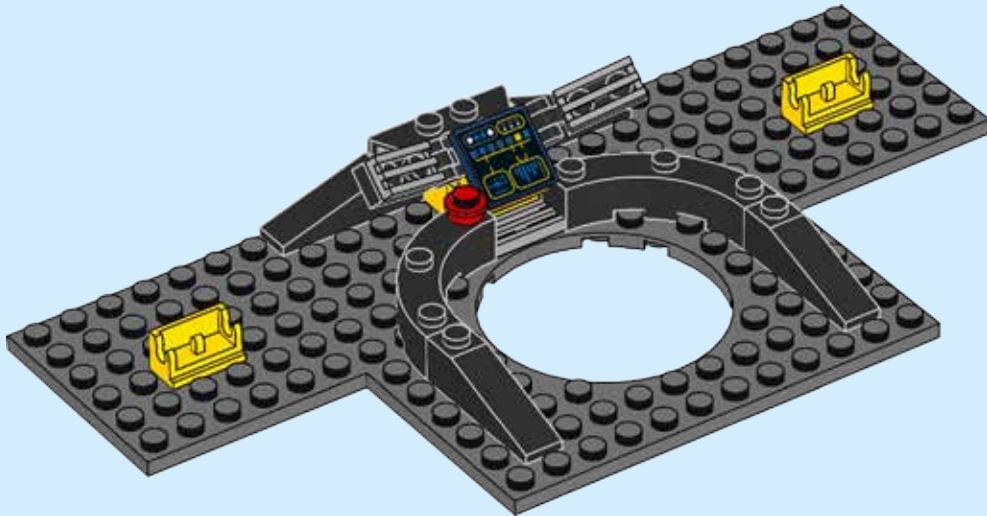

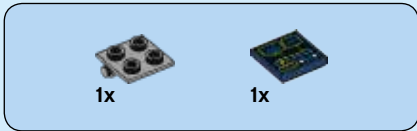

8

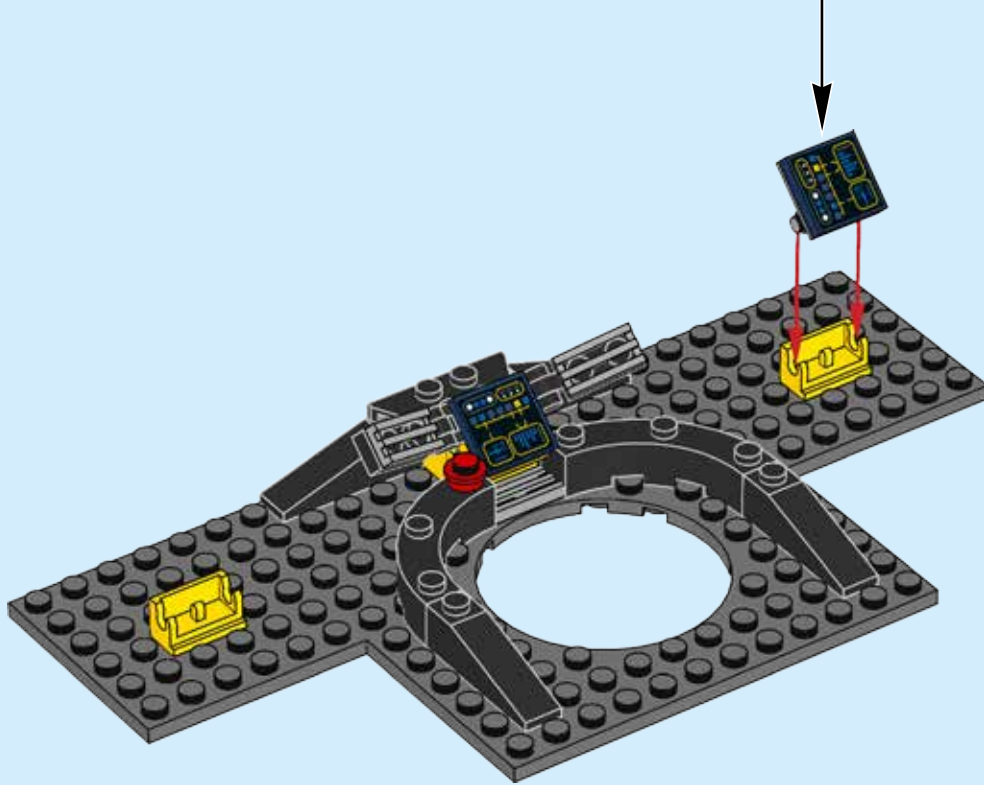
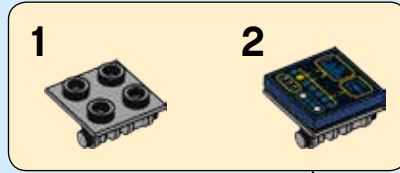

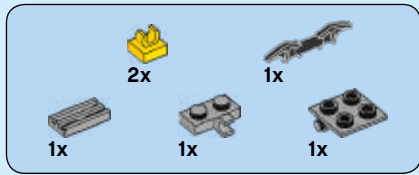

9

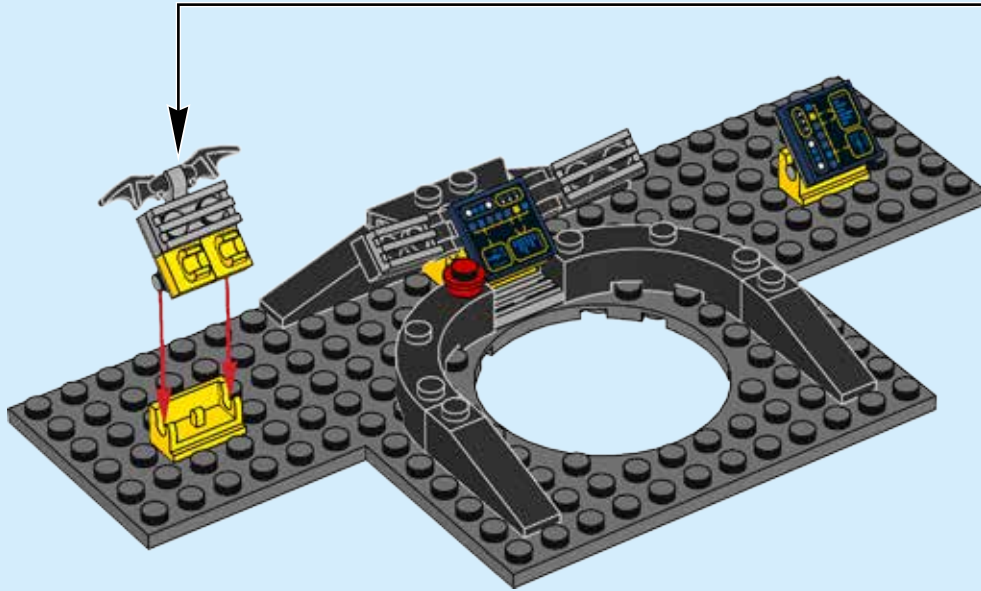
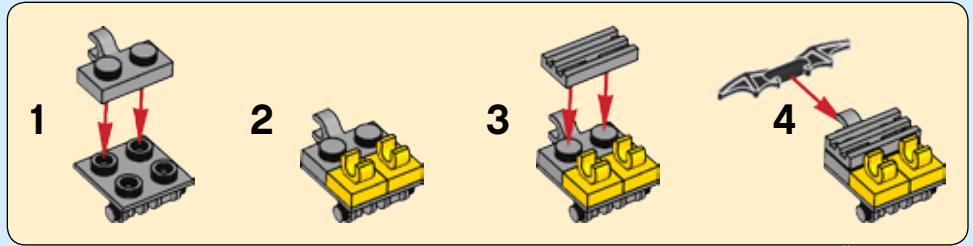



10

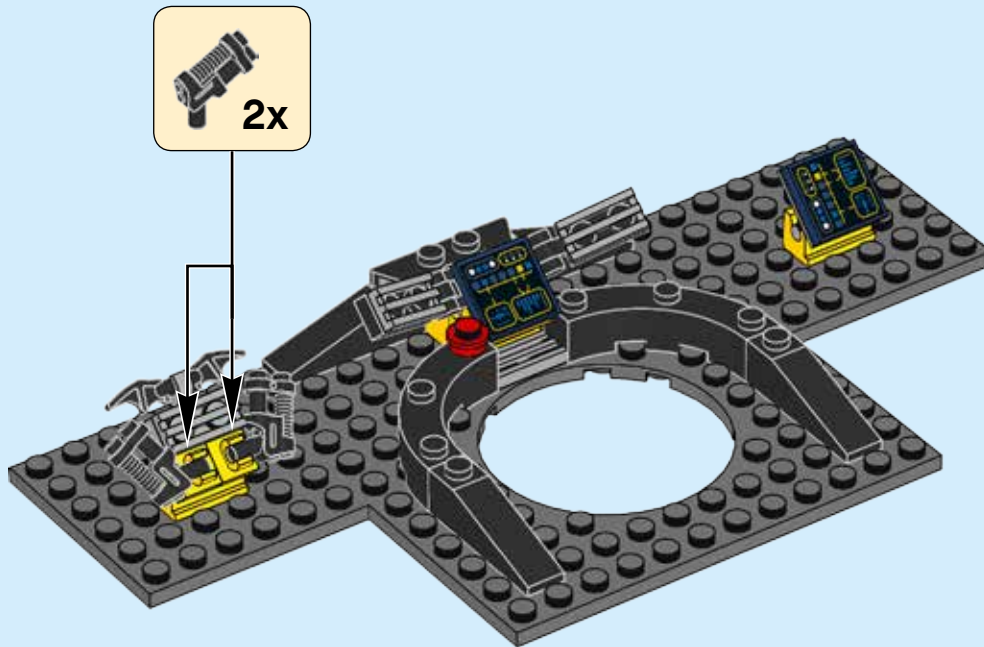

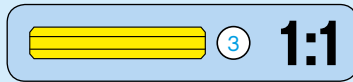
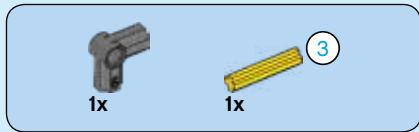

11

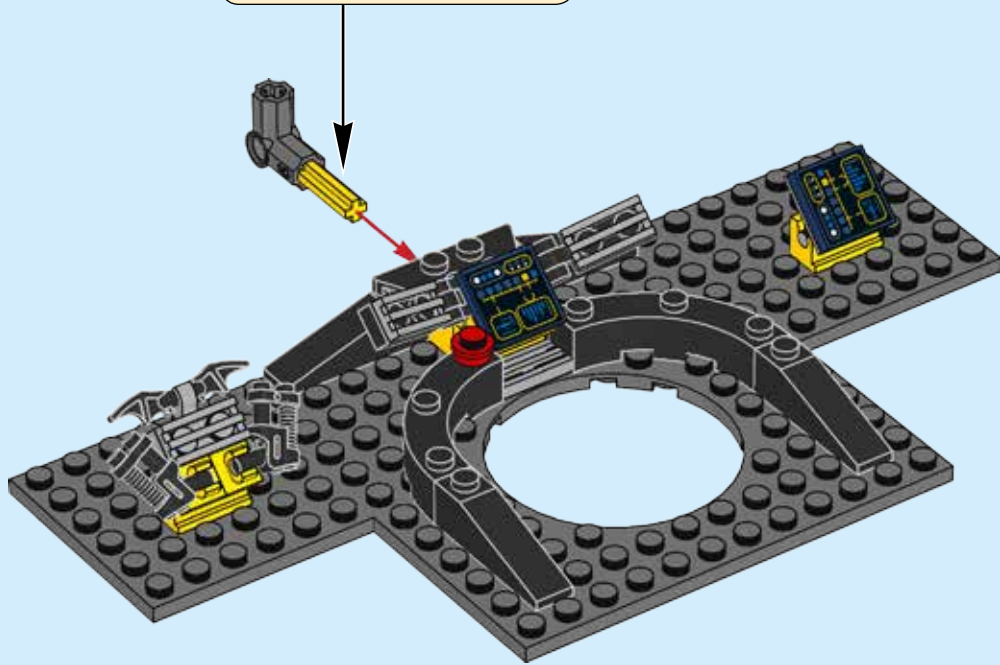
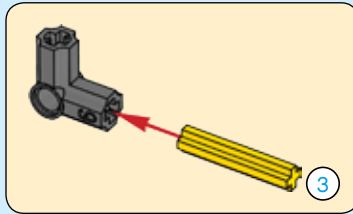

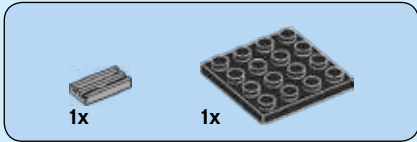
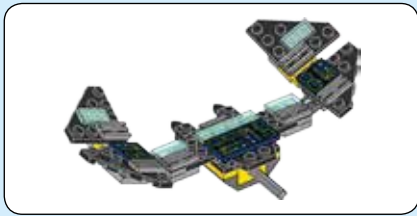

12

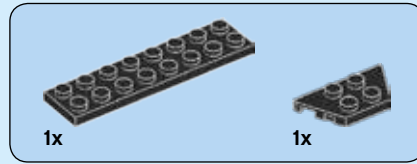
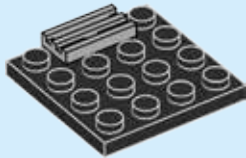

13

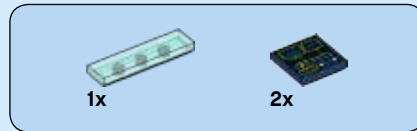
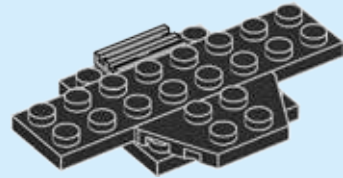

14

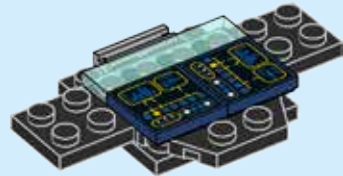



2x



2x

15

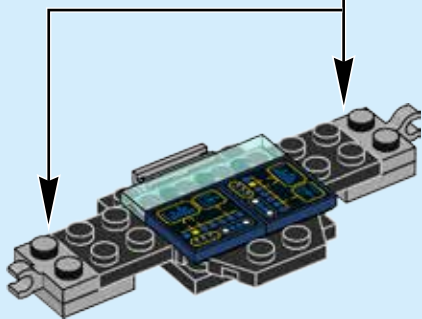
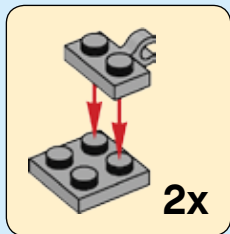

2x



2x

16

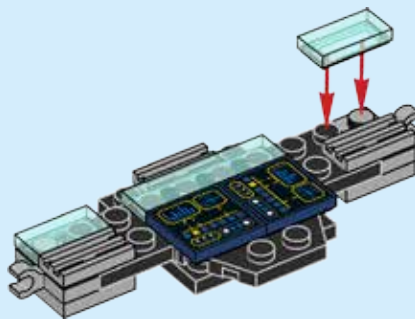

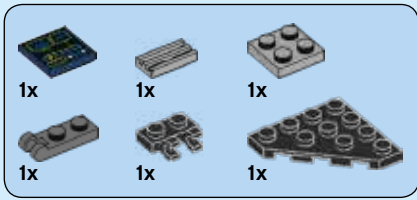

17

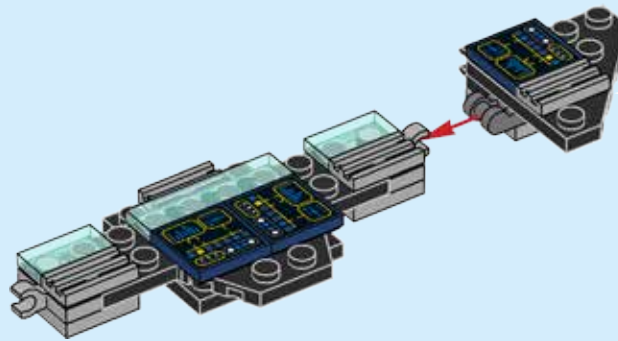
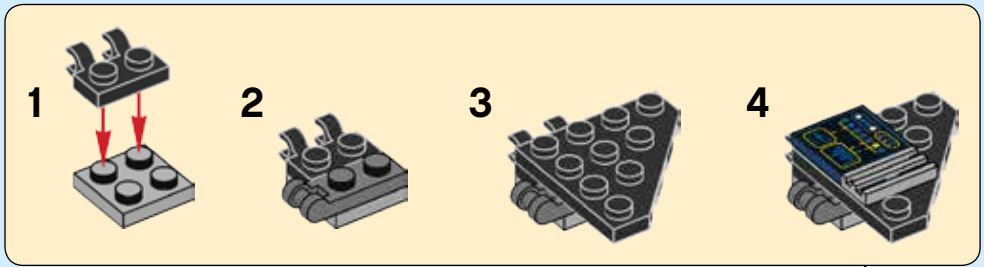

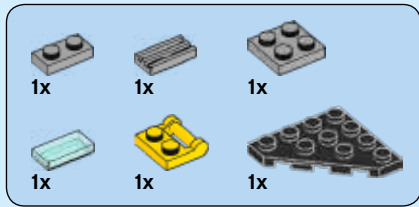

18

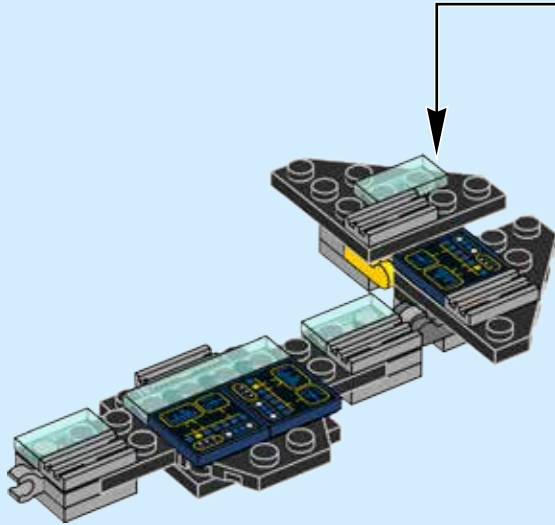
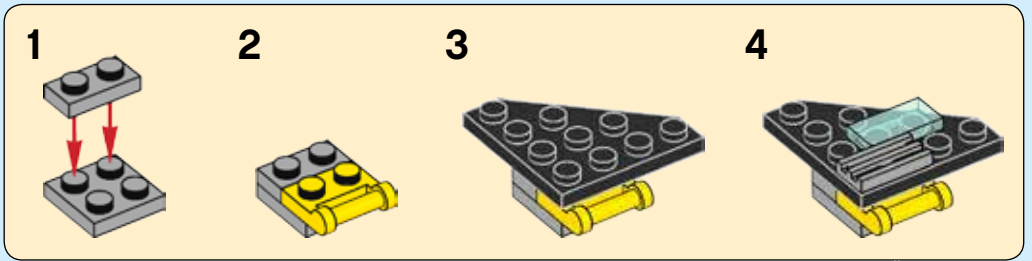

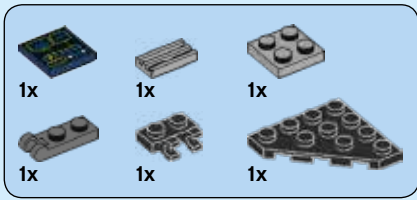

19

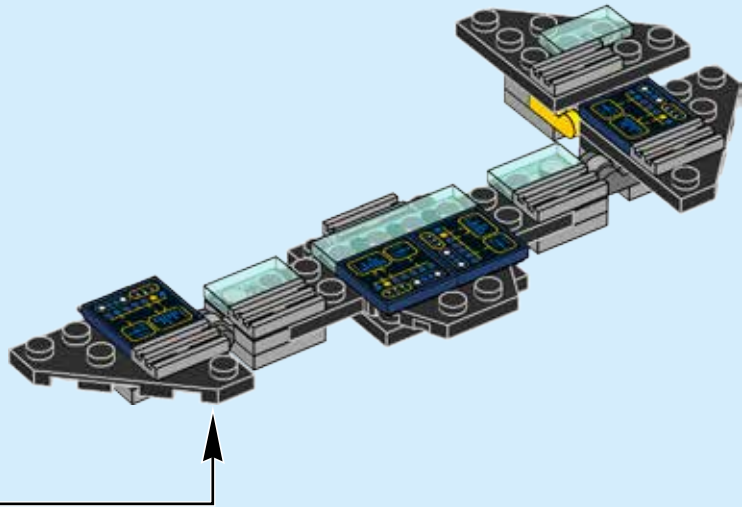
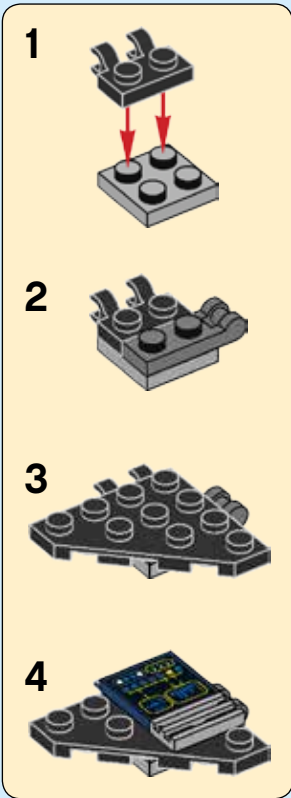

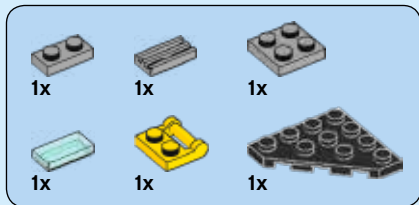

20

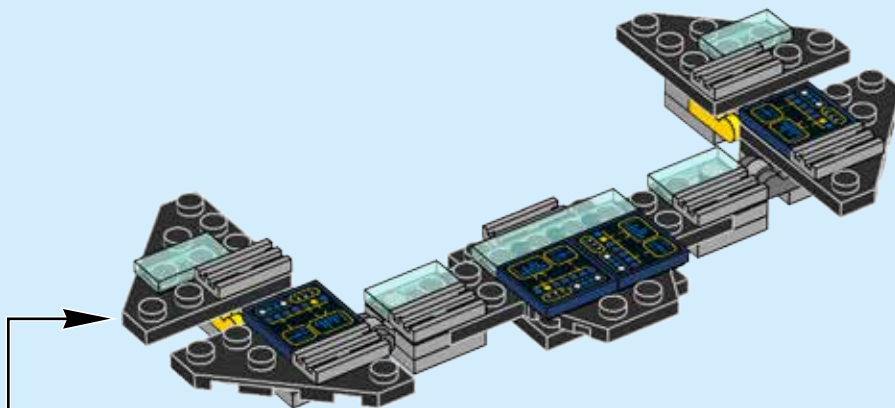
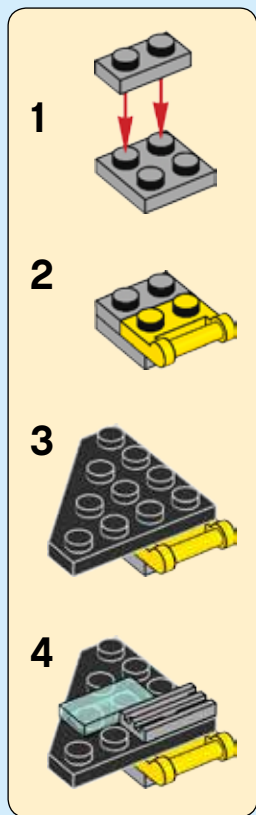



2x

21

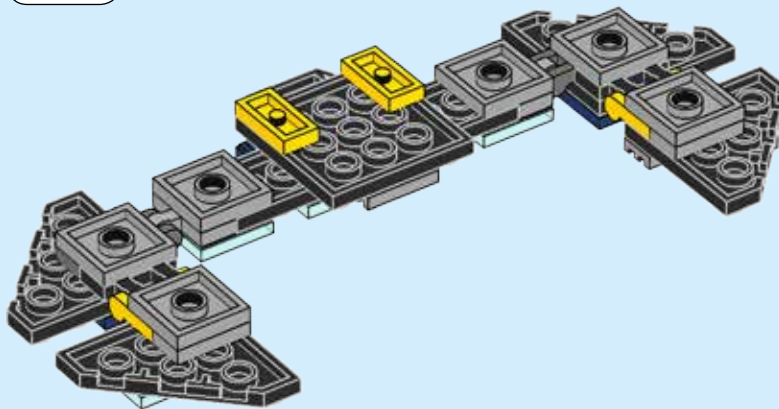
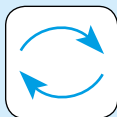



2x

22

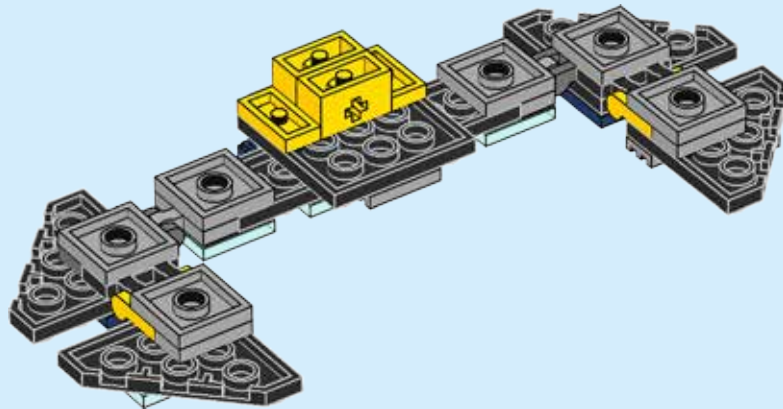

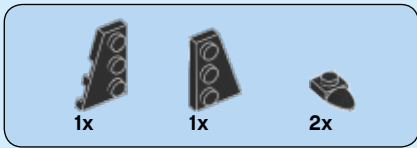

23

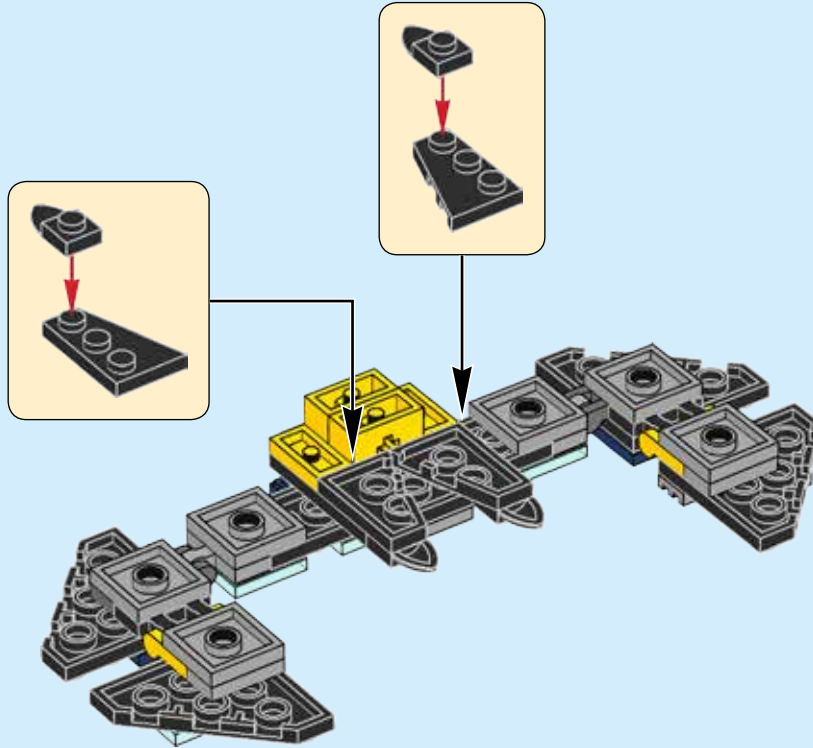

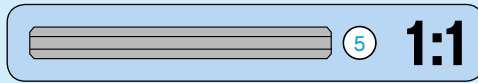
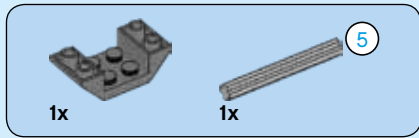

24

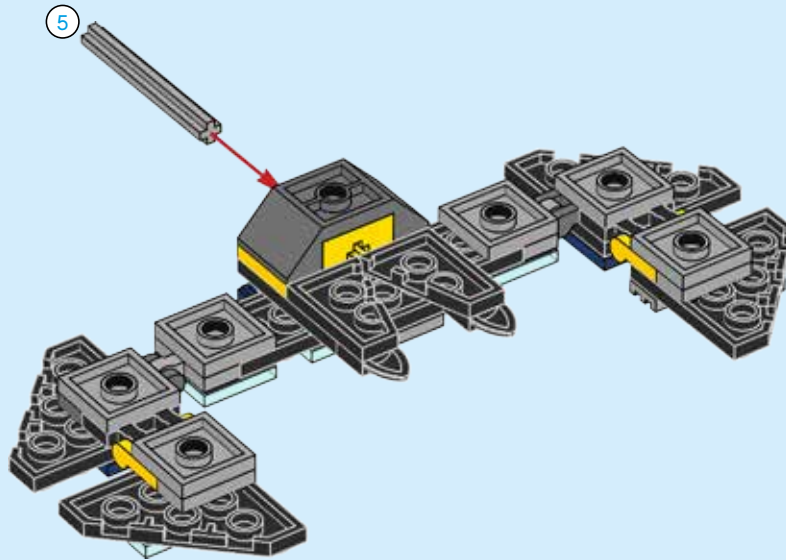

25

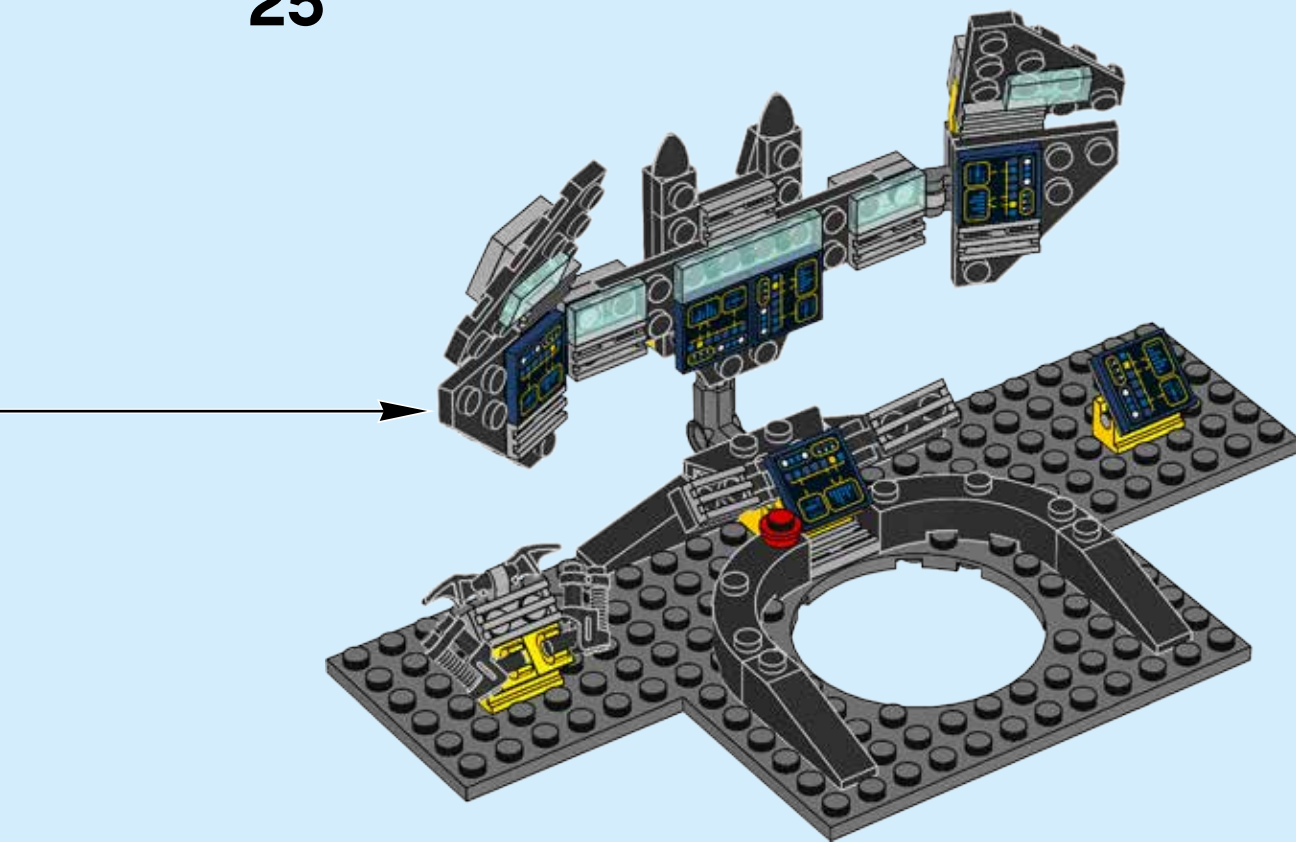





Download the latest game content to use this character

- Lade dir die neusten Spielinhalte herunter, um diese Figur zu benutzen
- Télécharge le contenu le plus récent du jeu pour utiliser ce personnage
- Download det nyeste spilindhold for at bruge denne figur
- Download de nieuwste game-inhoud om deze figuur te kunnen gebruiken
- Ladda ner det senaste spelinnehållet för att använda den här karaktären
- Last ned det nyeste spillinnholdet for å ta i bruk denne figuren
- Pääset käyttämään tätä hahmoa lataamalla pelin uusimman sisällön
- Descarga la última actualización de contenido para usar este personaje
- Scarica gli ultimi contenuti del gioco per usare questo personaggio

Start game
Spiel starten
Commencer à jouer

Start spillet
Game starten
Starta spelet

Aloita peli
Iniciar juego
Avvia il gioco

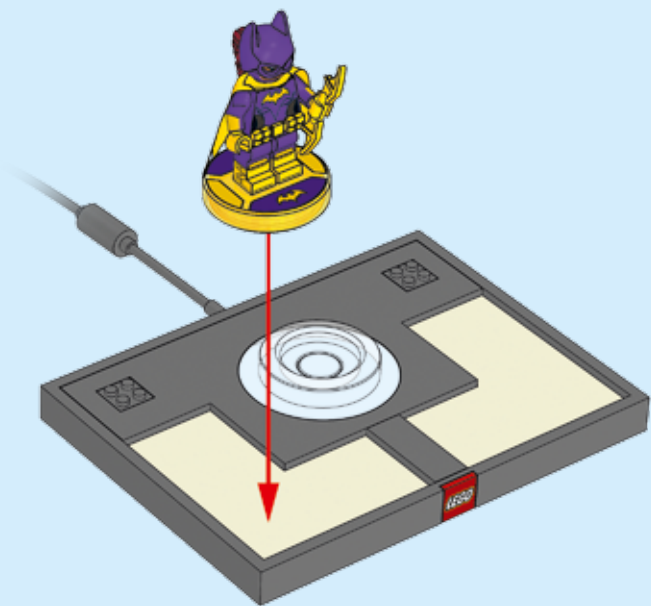



- Building is part of playing the game
- Das Bauen ist Teil des Spiels
- La construction fait partie du jeu
- Byggeri er en del af spillet
- Bouwen is een onderdeel van het spel
- Byggandet är en del av spelet
- Byggingen er en del av spillet
- Peliin kuuluu myös rakennustehtäviä
- Construir forma parte del juego
- La costruzione fa parte del gioco



DIMENSIONS™

LEVEL PACKS
LEVEL-PAKETE
PACK AVENTURE
LEVEL-PAKKETTEN
PACCHETTI LIVELLO



71203



71204



71228



71235



DIMENSIONS™

LEVEL PACKS
LEVEL-PAKETE
PACK AVENTURE
LEVEL-PAKKETTEN
PACCHETTI LIVELLO



71244



71245



71248



71267



DIMENSIONS™

TEAM PACKS
TEAM-PAKETE
PACK ÉQUIPE
TEAM-PAKKETTEN
PACCHETTI SQUADRA



71205



71206



71207



71229



DIMENSIONS™

TEAM PACKS
TEAM-PAKETE
PACK ÉQUIPE
TEAM-PAKKETTEN
PACCHETTI SQUADRA

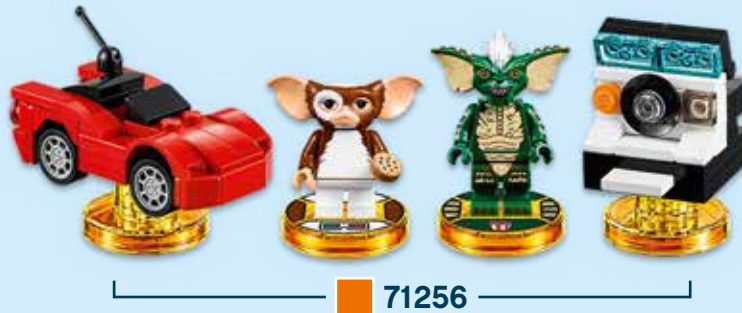



DIMENSIONS™

STORY PACKS
STORY-PAKETE
PACKS HISTOIRE
PACCHETTI STORIA

GHOSTBUSTERS



71242

FROM J.K. ROWLING'S
WIZARDING WORLD

FANTASTIC BEASTS

AND WHERE
TO FIND THEM



71253



DIMENSIONS™

FUN PACKS
SPAß-PAKETE
PACK HÉROS
PRET-PAKKETTEN
PACCHETTI DIVERTIMENTO



71230



71233



71234



71236



71237



71238



71239



71240



71241



DIMENSIONS™

FUN PACKS
SPAß-PAKETE
PACK HÉROS
PRET-PAKKETTEN
PACCHETTI DIVERTIMENTO



71251



71257



71258



71285



71286



71344



3

5



Customer Service
 Kundenservice
 Service Consommateurs
 Kundeservice
 Klantenservice
 Kundtjänst
 Asiakaspalvelu
 Atención al cliente
 Assistenza clienti
LEGO.com/DIMENSIONS/service

CHEAT CODES

GO TO LEGO.COM/DIMENSIONSfeedback AND
GIVE US YOUR SHORT **FEEDBACK** ABOUT THIS
LEGO® VIDEO GAME TO UNLOCK
AWESOME CHEAT CODES.



Terms & Conditions apply

LEGO.com/DIMENSIONSfeedback

GEHEIM-CODES

Geh auf LEGO.com/DIMENSIONSfeedback und verrate uns deine Meinung zu diesem LEGO® Videospiel, um tolle Geheim-Codes freizuschalten.

Es gelten die Nutzungsbedingungen.

COUPS DE POUCE

Rendez-vous sur LEGO.com/DIMENSIONSfeedback pour évaluer ce jeu vidéo LEGO® et débloquent de super coups de pouce !

Offre soumise à conditions.

CHEATCODES

Ga naar LEGO.com/DIMENSIONSfeedback, schrijf een kort commentaar op deze LEGO® video game en ontvang coole cheatcodes.

Er zijn algemene voorwaarden van toepassing.

CÓDIGOS DE TRUCOS

Visita LEGO.com/DIMENSIONSfeedback y envíanos una breve opinión sobre este videojuego LEGO® para desbloquear asombrosos códigos de trucos.

Sujeto a términos y condiciones.