



# SUPER MARIO™



71428





LEGO.com/sustainable-packaging



FR  
DONNEZ  
OU  
RECYCLEZ



ASSOCIATION

OU



MAGASIN

OU



DÉCHÈTERIE

Adresses sur [quefairedemesdechets.fr](http://quefairedemesdechets.fr)

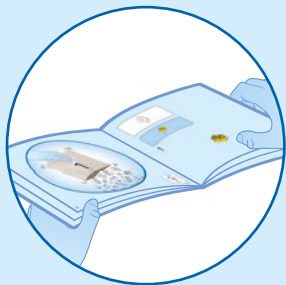



LEGO® Super Mario™ app



# 1. Scan QR code to build from digital building instruction



- |   |   |   |   |
|---|---|---|---|
| <ol style="list-style-type: none"><li>1. Scan QR code to build from digital building instruction</li><li>2. Open digital building instruction</li><li>3. Start building</li></ol>   | <ol style="list-style-type: none"><li>1. Für digitale Bauanleitung den QR-Code scannen</li><li>2. Digitale Bauanleitung öffnen</li><li>3. Der Bauspaß kann beginnen</li></ol>   | <ol style="list-style-type: none"><li>1. Scanne le code QR pour construire avec les instructions de montage numériques</li><li>2. Ouvre les instructions de montage numériques</li><li>3. Commence à construire</li></ol> | <ol style="list-style-type: none"><li>1. Scansiona il codice QR per scaricare le istruzioni digitali per costruire</li><li>2. Apri le istruzioni digitali per costruire</li><li>3. Inizia a costruire</li></ol> |
| <ol style="list-style-type: none"><li>1. Escanea el código QR para construir con instrucciones de construcción digitales</li><li>2. Abre las instrucciones de construcción digitales</li><li>3. Empieza a construir</li></ol> | <ol style="list-style-type: none"><li>1. Lê o código QR para construir utilizando as Instruções de Construção digitais</li><li>2. Abrir as instruções de construção digitais</li><li>3. Começar a construir</li></ol> | <ol style="list-style-type: none"><li>1. 扫描二维码, 在数字拼搭说明的协助下拼搭</li><li>2. 打开数字拼搭说明</li><li>3. 开始拼搭</li></ol>   | <ol style="list-style-type: none"><li>1. Zeskanuj kod QR, aby budować dzięki cyfrowym instrukcjom budowania</li><li>2. Otwórz cyfrową instrukcję budowania</li><li>3. Rozpocznij budowanie</li></ol>            |

## 2. Open digital building instruction

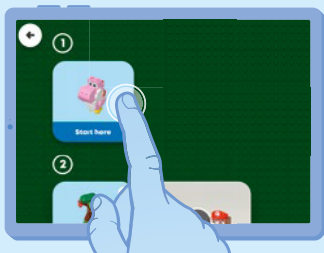

1. Naskenujte QR kóda a stavte podle digitálního návodu
2. Otevřete digitální návod na stavění
3. Pustte se do stavění

1. Сканирайте QR кода, за да започнете строите с цифрови инструкции за построяване
2. Отворете цифровите инструкции за построяване
3. Започнете да строите

1. Naskenujte QR kód a stavajte podľa digitálneho návodu
2. Otvorte digitálny návod na stavanie
3. Pustite sa do stavania

1. Skenē QR kodu, lai būvētu, izmantojot digitālas būvēšanas instrukcijas
2. Atver digitālo būvēšanas instrukciju
3. Sākt būvēt

## 3. Start building

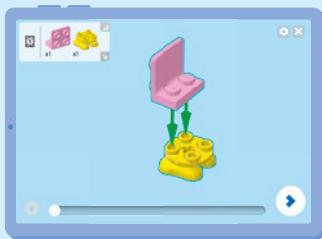

1. Olvasd be a QR-kódot a digitális építési útmutató használatához!
2. Digitális építési útmutató megnyitása
3. Kezdődjön az építés!

1. Skanni QR-kood, et ehitada digitaalsete ehitusjuhistege
2. Ava digitaalsed ehitusjuhised
3. Alusta ehitamist

1. Scanează codul QR pentru a construi pe baza instrucțiunilor digitale
2. Deschide instrucțiunile de construcție digitale
3. Începe să construiești

1. Nuskaitykite QR kodą ir konstruokite naudodamiesi skaitmeninėmis instrukcijomis
2. Atidarykite skaitmenines instrukcijas
3. Konstruokite



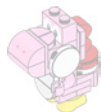

1x

1





1x



1x

2



8





1x

3

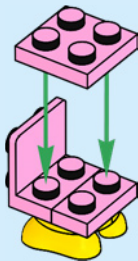



2x

4

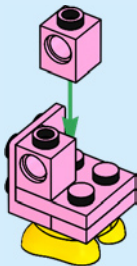



2x

5

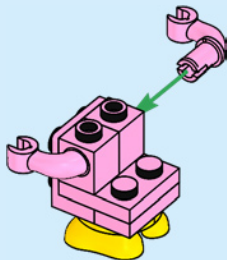



1x

6

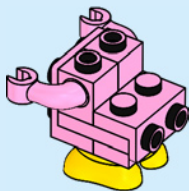



1x

7

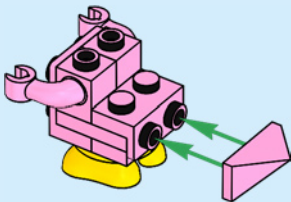



1x



1x



1x

8

1

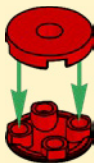

2

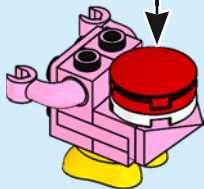
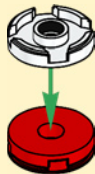



1x



1x

9

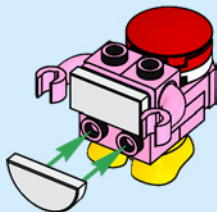



1x

10

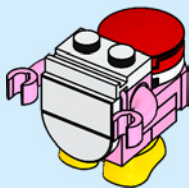





1x

11





1x

12

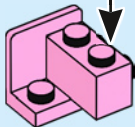
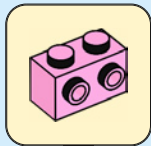



1x

13

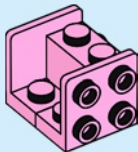



1x

14

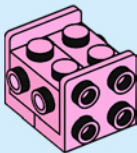

20



2x

15

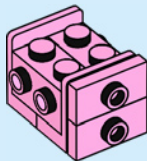



2x

16

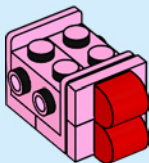

22



2x

17

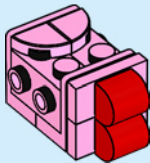

1x

18

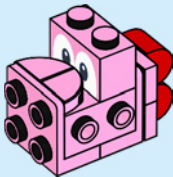



1x



1x

# 19

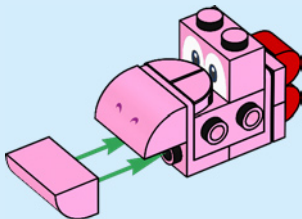

24



20

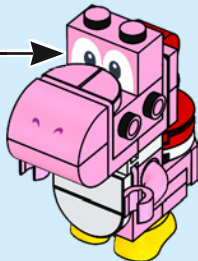



2x

21

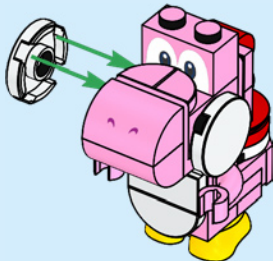



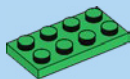

1x

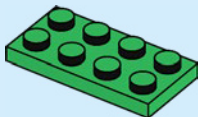

1



1x



1x

# 2

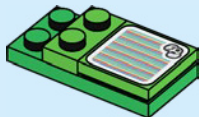

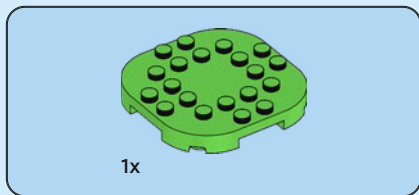

3

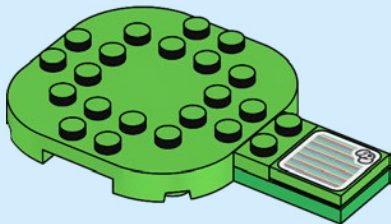



2x

4

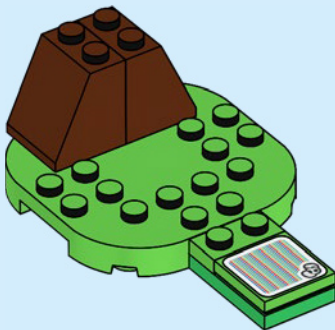



1x

5

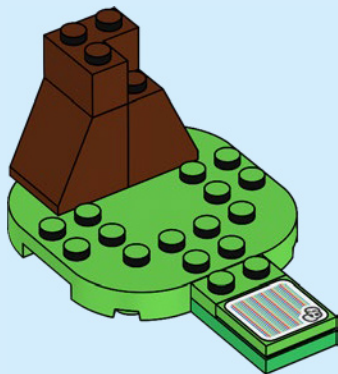





1x

6

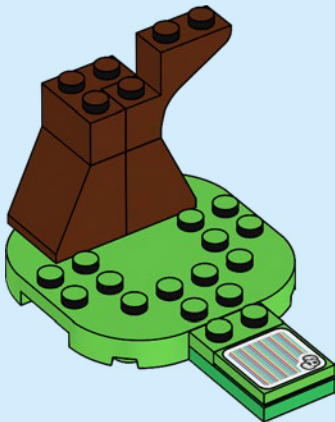



1x

7

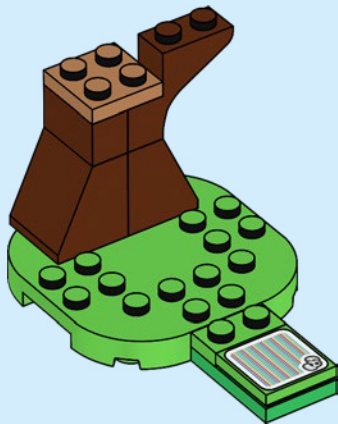

34

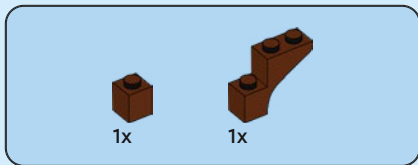

8

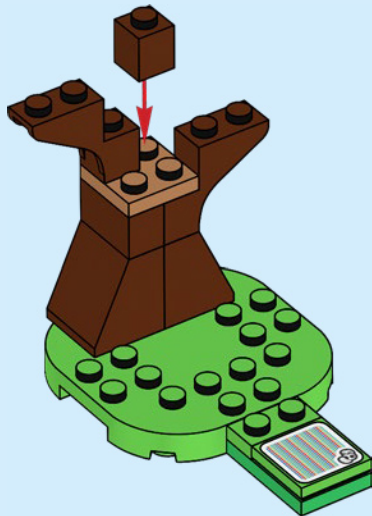



1x



1x

9

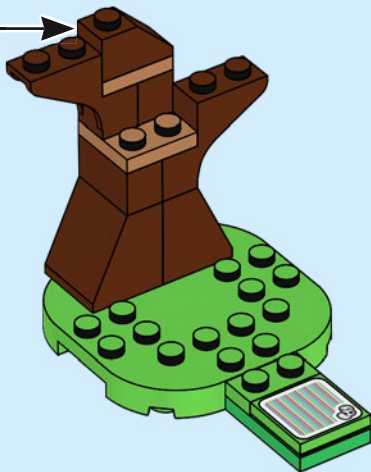
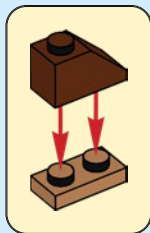



1x

10

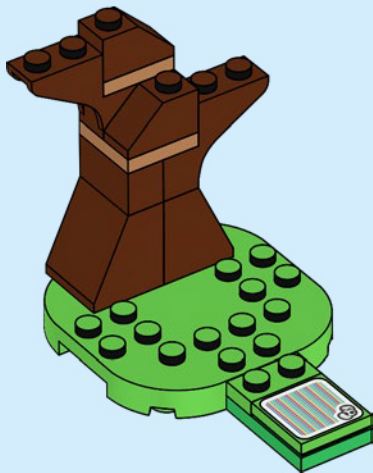



2x

11

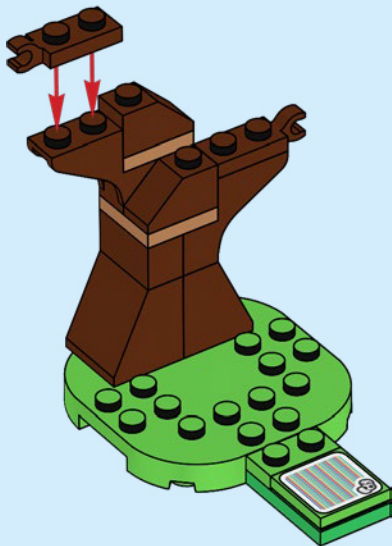

38



3x



2x

# 12

## 1

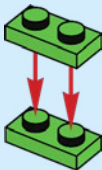

## 2

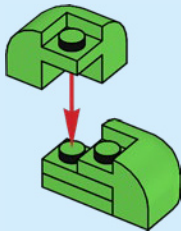

## 3

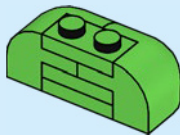

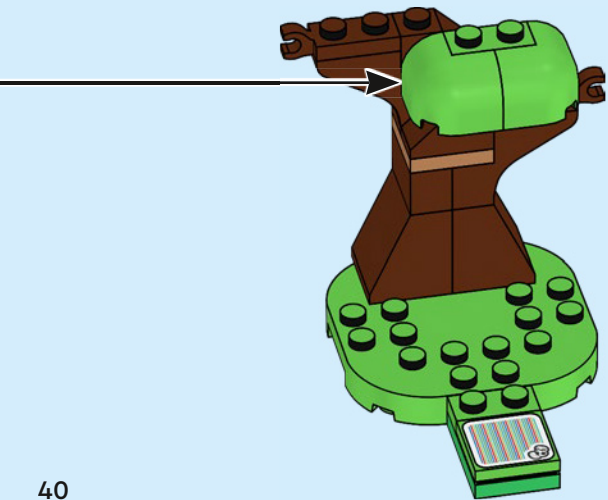





3x



1x



2x

# 13

1

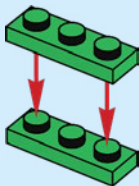

2

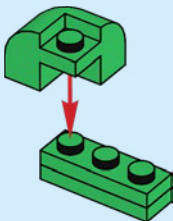

3

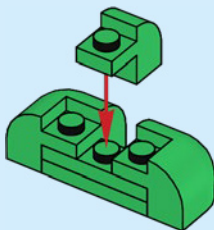

4

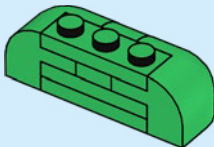

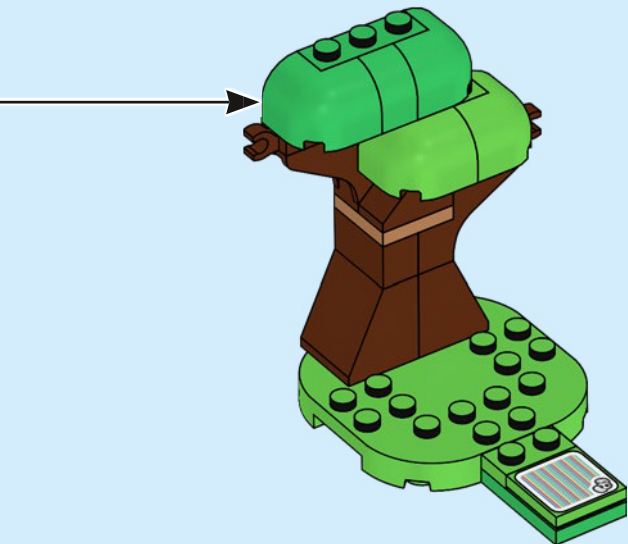



1x



1x

14

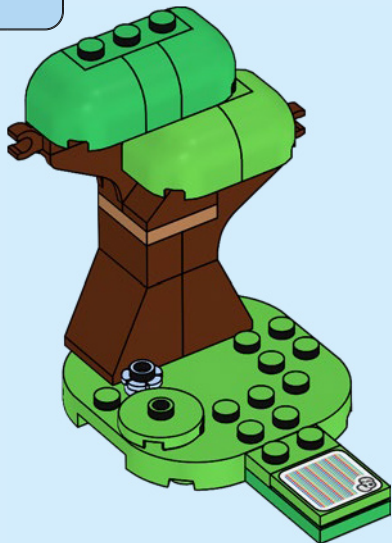



1x



4x



1x

# 15

1



2



3



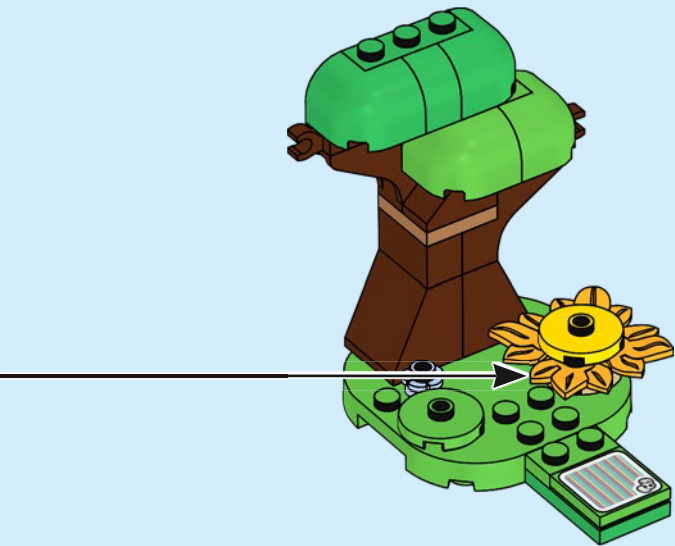



1x

16



46



2x

17

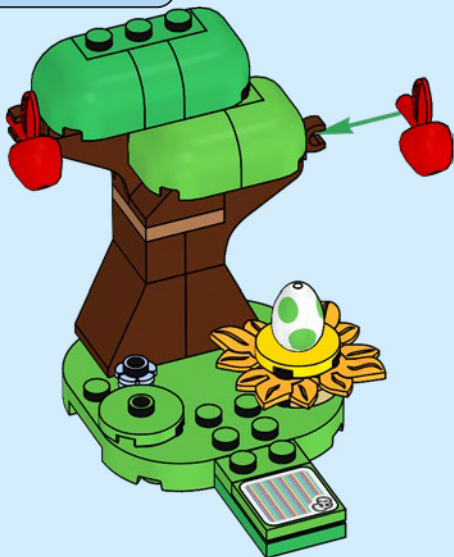





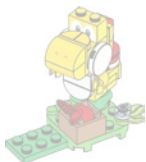

1x

1





1x



1x

2





1x

3

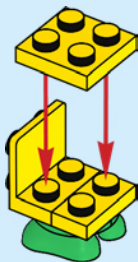



2x

4

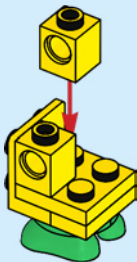



2x

5

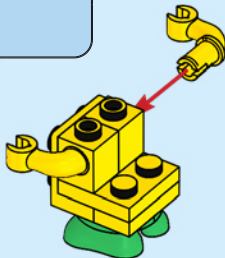

1x

6

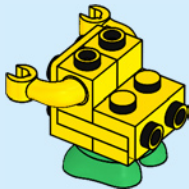



1x

7

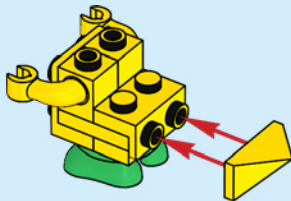

54



1x



1x



1x

8

1

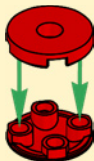

2

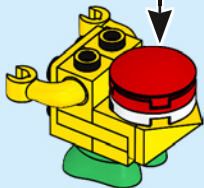
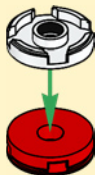



1x



1x

9

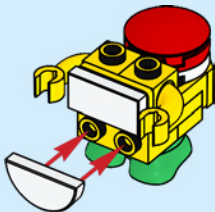





1x

10

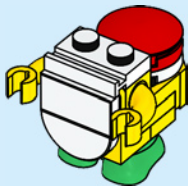



1x

# 11





1x

# 12

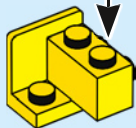
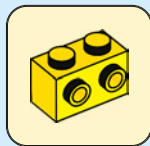



1x

13

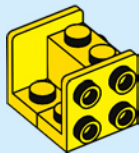



1x

14





2x

15

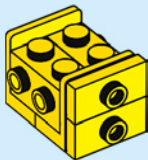



2x

16

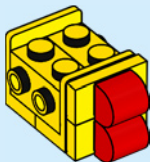

2x

17

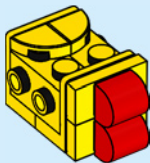



1x

18

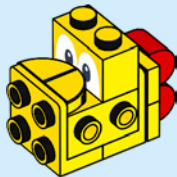





1x



1x

19

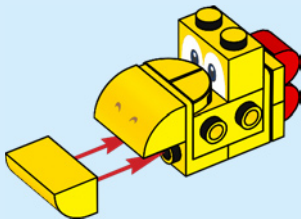

20

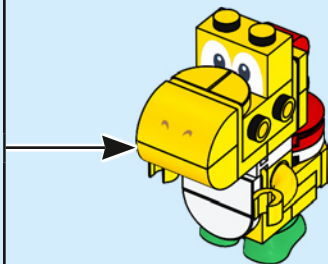



2x

21

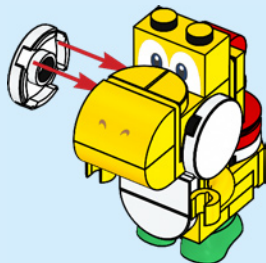

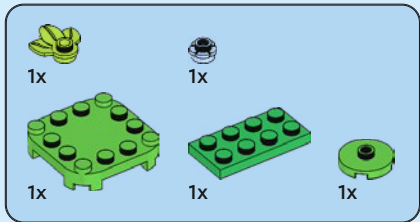
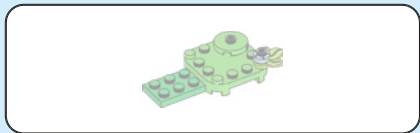

22  
1

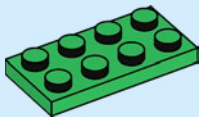

2

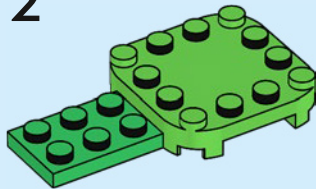

3

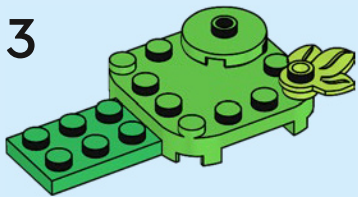

4

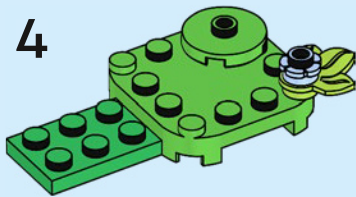

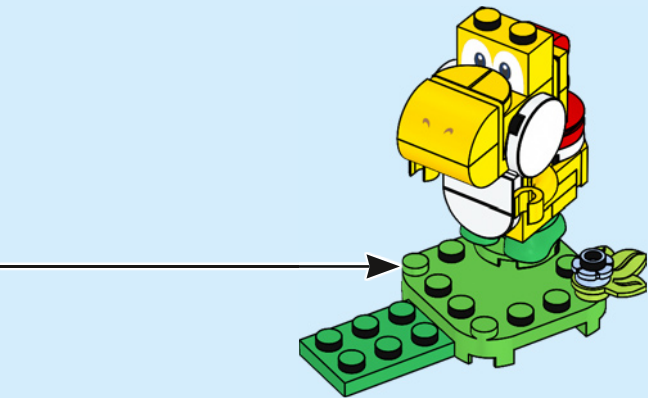



1x



1x

# 23

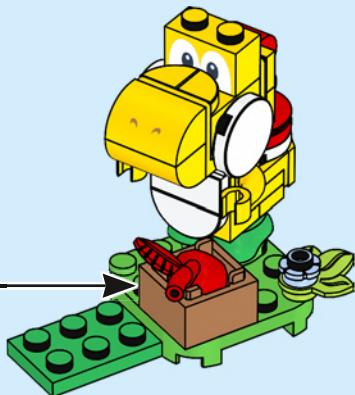
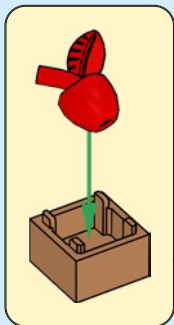

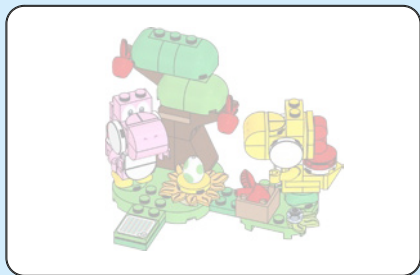

1

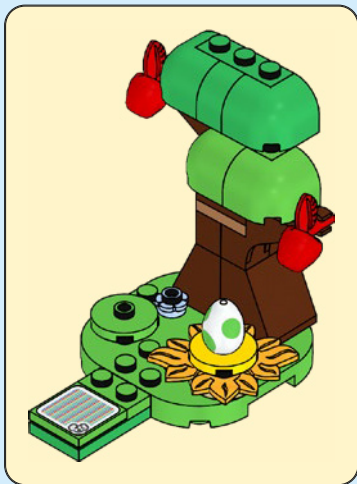



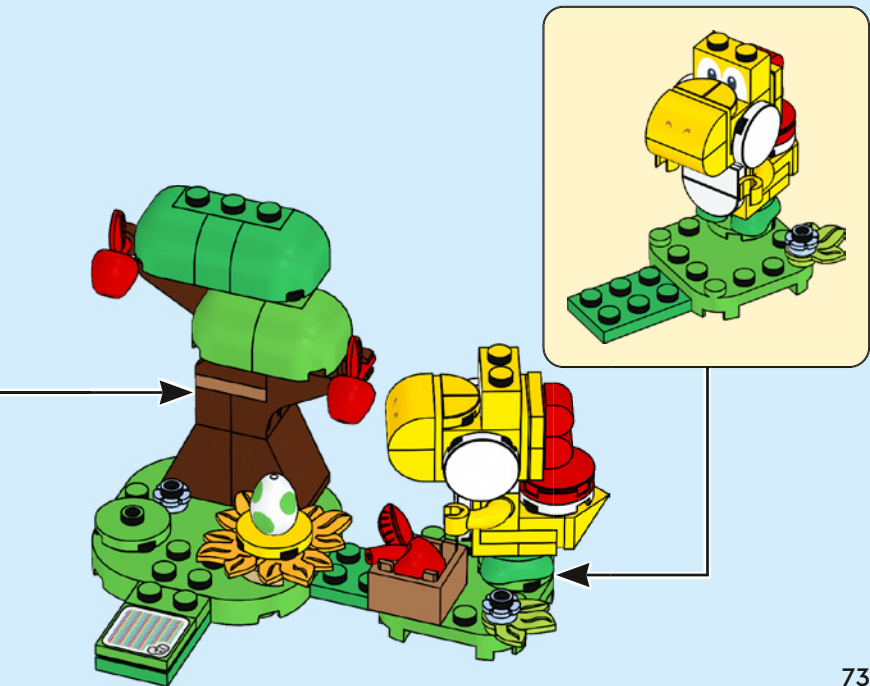

2

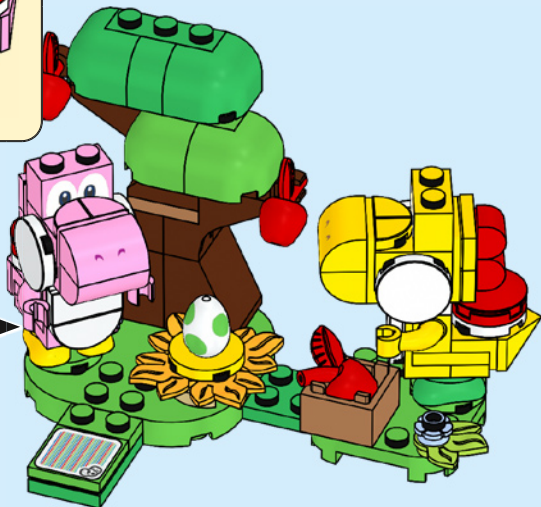
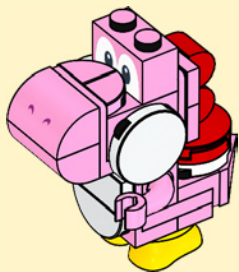

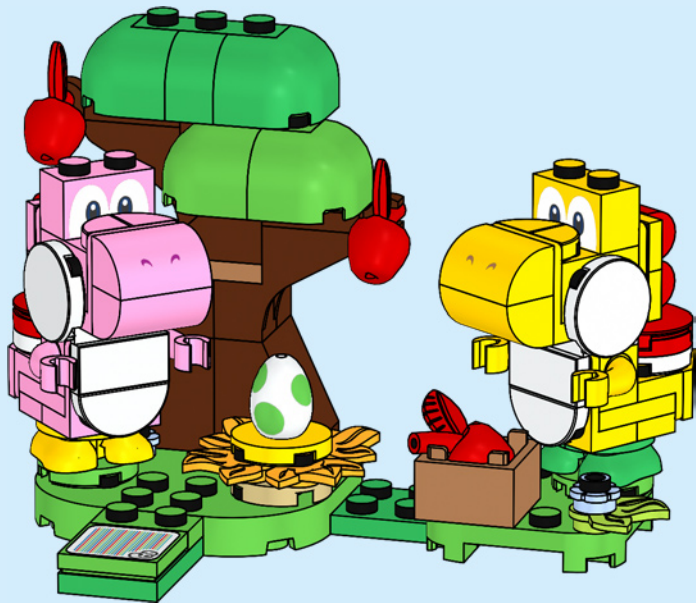

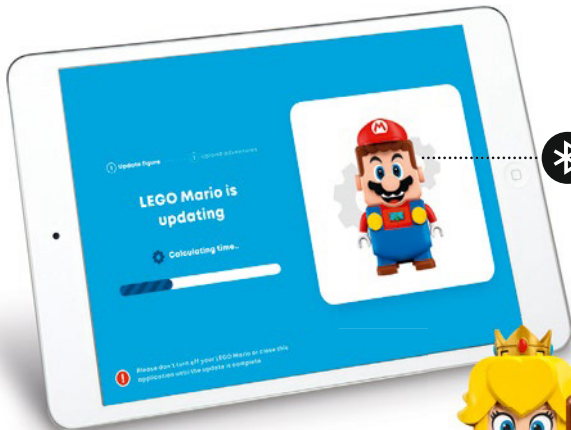

**UPDATE YOUR  
INTERACTIVE FIGURE  
IN THE LEGO®  
SUPER MARIO™ APP TO  
BE READY TO PLAY**



Update your interactive figure in the LEGO® Super Mario™ app to be ready to play / Aktualisiere deine interaktive Figur in der LEGO® Super Mario™ App und das Spiel kann beginnen / Mets à jour ta figurine interactive dans l'appli LEGO® Super Mario™ avant de jouer / Aggiorna il tuo personaggio interattivo nell'app LEGO® Super Mario™ perché sia pronto per giocare / Actualiza tu figura interactiva en la app LEGO® Super Mario™ y prepárate para jugar / Atualiza a tua figura interativa na aplicação LEGO® Super Mario™ para começar a jogar / 在乐高® 超级马力欧应用程序中更新你的交互式人偶，为玩乐做好准备 / Zaktualizuj swoją interaktywną figurkę w aplikacji LEGO® Super Mario™, aby przygotować ją do zabawy / Aktualizujte interaktivní figurku v aplikaci LEGO® Super Mario™, abyste se mohli pustit do hrani / Aktualizujte interaktivnú figurku v aplikácii LEGO® Super Mario™, aby ste mohli pustiť do hrania / Frissítsd interaktív figurád a LEGO® Super Mario™ alkalmazásban és készülj fel a játékra! / Actualizează-ți figurina interactivă în aplicația LEGO® Super Mario™ pentru a fi gata de joacă / Актуалізіруйте інтерактивна фігура в додатку LEGO® Super Mario™, за да сте готови за гру / Atjaunini savu interaktīvo figūru LEGO® Super Mario™ lietotnē, lai būtu gatavs rotaļāties / Vārskenda oma interaktīviset figuuri rakenduses LEGO® Super Mario™, et olla mängimiseks valmis / Atnaujinkite interaktyvią figurėlę programėlyje „LEGO® Super Mario™“ ir pasiruoškite žaisti



### LEGO® Super Mario™ app

LEGO® Super Mario™ App / Appli LEGO® Super Mario™ / App LEGO® Super Mario™ / App LEGO® Super Mario™ / Aplicação LEGO® Super Mario™ / 乐高®超级马力欧™应用程序 / Aplikacja LEGO® Super Mario™ / Aplikace LEGO® Super Mario™ / Aplikácia LEGO® Super Mario™ / LEGO® Super Mario™ alkalmazás / Aplicația LEGO® Super Mario™ / Приложение LEGO® Super Mario™ / LEGO® Super Mario™ lietotne / LEGO® Super Mario™ rakendus / Programèlè „LEGO® Super Mario™“



**LEGO.com/super-mario  
-trouble-shooting-guide**



**DISCOVER MORE  
ABOUT YOUR  
SET IN THE APP**



Discover more about your set in the app  
Entdecke in der App noch mehr über dein Set  
Découvre plus de détails sur ton set dans l'appli  
Scopri di più sul tuo set nell'app  
Descubre más acerca de tu set en la app  
Conhece melhor o teu set na aplicação  
可通过应用程序了解更多关于此套装的信息  
Dowiedz się więcej sprawdzając w aplikacji  
Zjistěte více o své stavebnici v aplikaci  
Zisti viac o svojej stavebnici v aplikácii  
Tudj meg többet a készletről az alkalmazásban!  
Descoperă mai multe despre setul tău în aplicație  
Открийте повече за комплекта в приложението  
Atklāj vairāk par komplektu lietotnē  
Avasta oma komplekti kohta  
lisateavet rakendusest  
Sužinokite daugiau apie rinkinį programėlėje



71429

71360

71428

71432





71430



71431



71360

Starter Course 71360 and/or 71387 and/or 71403 needed

Starterset 71360 und/oder 71387 und/oder 71403 wird benötigt

Pack(s) de démarrage 71360 et/ou 71387 et/ou 71403 nécessaire(s)

Starter Pack 71360 e/o 71387 e/o 71403 necessari

Se necesita el Pack Inicial 71360 y/o 71387 y/o 71403

Necessita do Pack Inicial 71360 e/ou 71387 e/ou 71403

スターターセット (71360/71387/71403 のいずれか) が必要です

需要入门套组 71360 和/或 71387 和/或 71403

스타터팩 71360, 71387 또는 71403 이 필요합니다

Для игры необходимы Стартовые наборы (арт. 71360 и/или 71387, и/или 71403)

Potrzebne są zestawy startowe 71360, 71387 i/lub 71403

Je zapotřebí startovací set 71360 nebo 71387 nebo 71403

Je potrebný štartovací set 71360 a/alebo 71387 a/alebo 71403

A 71360-as és/vagy a 71387-es és/vagy a 71403-as Kezdőpálya szükséges

Este nevoie de Setul de bază 71360 și/sau 71387 și/sau 71403

Нужни са начална писта 71360 и/или 71387 и/или 71403

Nepieciešams sākuma maršruta komplekts 71360 un/vai 71387, un/vai 71403

Vaja on alustusrada 71360 ja/või 71387 ja/või 71403

Reikalingas pradinis rinkinys 71360 ir (arba) 71387 ir (arba) 71403



1x  
6465273



2x  
6400114



4x  
6044691



2x  
6093053



2x  
306901



2x  
4249563



1x  
4140562



4x  
6278441



3x  
6054438



2x  
4278275



2x  
6102138



2x  
654124



2x  
6195183



1x  
6381923



1x  
6299764



1x  
302324



2x  
6092583



2x  
6119197



1x  
6382136



1x  
6297284



1x  
6309099



1x  
6185994



3x  
6208753



2x  
6315218



1x  
6302719



1x  
302224



1x  
6374489



1x  
6315100



2x  
6397231



3x  
4107758



2x  
302028



2x  
6380676



4x  
6343326



1x  
6474128



2x  
6383615

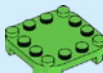

1x  
6308875

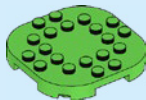

1x  
6301631



1x  
6286831



4x  
6378797



1x  
4211242



2x  
4211199



2x  
6338135



2x  
4211320



1x  
4211200



2x  
6186577



2x  
6209683



2x  
6353190



2x  
6240463



1x  
6353194



2x  
6264994



1x  
4654128



2x  
6353192



1x  
6353864



1x  
6314374



1x  
6353865



3x  
6288181



1x  
6096589



1x  
6353189



2x  
6359698



1x  
6435640



1x  
6218360



1x  
6056383



LEGO.com/service

YOU COULD

WIN

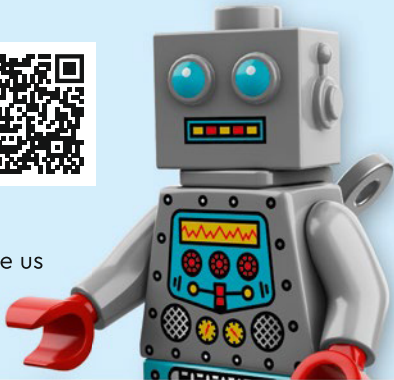

Scan this QR code or go to  
**LEGO.COM/PRODUCTFEEDBACK** and give us  
your short feedback about this LEGO® set  
for a chance to win a cool LEGO prize.

Terms and Conditions apply\*

**EN: YOU COULD WIN.** Terms and Conditions apply\* **DE: Du könntest GEWINNEN.** Es gelten die Teilnahmebedingungen\* **FR: Tu pourrais GAGNER.** Des conditions s'appliquent\* **IT: Potresti VINCERE tu.** Termini e condizioni sono applicabili\* **ES: Puedes GANAR.** Aplican términos y condiciones\* **PT: Poderá GANHAR.** Aplicam-se termos e condições\* **ZH: 轻松获奖.** 条款和条件适用\* **PL: Szansa na WYGRANĄ.** Obowiązują warunki korzystania\* **CS: Máte šanci VYHRÁT.** Platí všeobecné smluvní podmínky\* **SK: Máte šancu VYHRÁŤ.** Platia všeobecné zmluvné podmienky\* **HU: TE IS NYERHETSZ.** Felhasználási feltételek érvényesek\* **RO: Ai putea CÂȘTIGA.** Se aplică termeni și condiții\* **BG: Можете да СПЕЧЕЛИТЕ.** Има определени правила и условия\* **LV: Tu vari LAIMĒT.** Ir spēkā noteikumi un nosacījumi.\* **ET: Sul on võimalus VÕITA.** Kehtivad tingimused\* **LT: Jūs galite LAIMĖTI.** Taikomos sąlygos\*

\*[LEGO.com/productfeedback-terms](https://www.lego.com/productfeedback-terms)

LEGO, the LEGO logo and the Brick and Knob configurations are trademarks and/or copyrights of the LEGO Group.  
©2024 The LEGO Group. 6497856

TM & © 2024 Nintendo.