



NINJAGO

71787



2



1

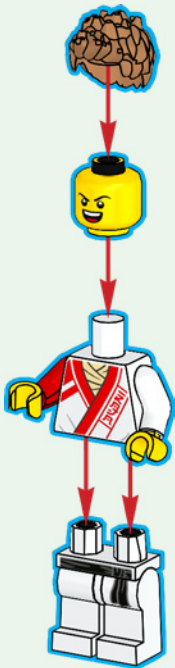

2

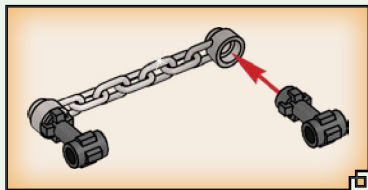

3

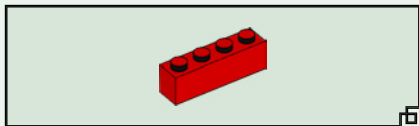
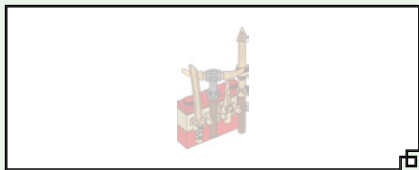

1

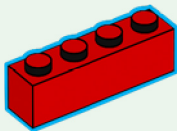

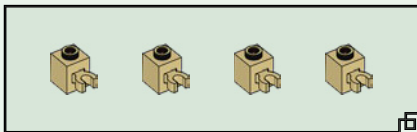

2

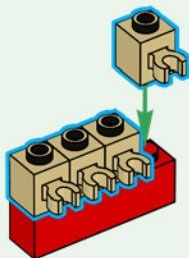

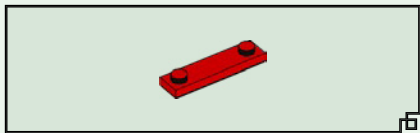

3

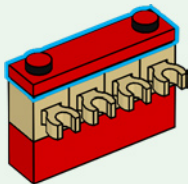

6





4

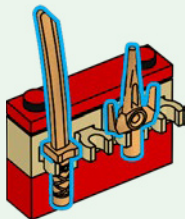

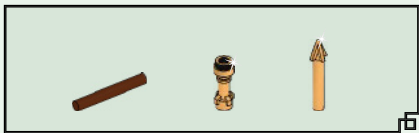

5

1

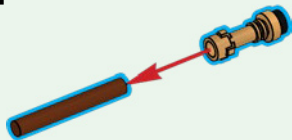

2

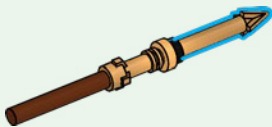

8



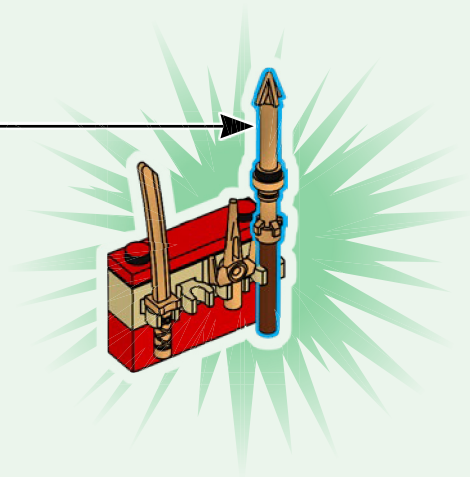

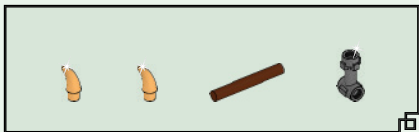

6

1

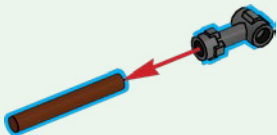

2

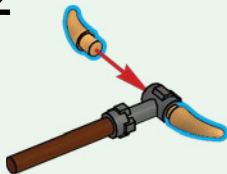

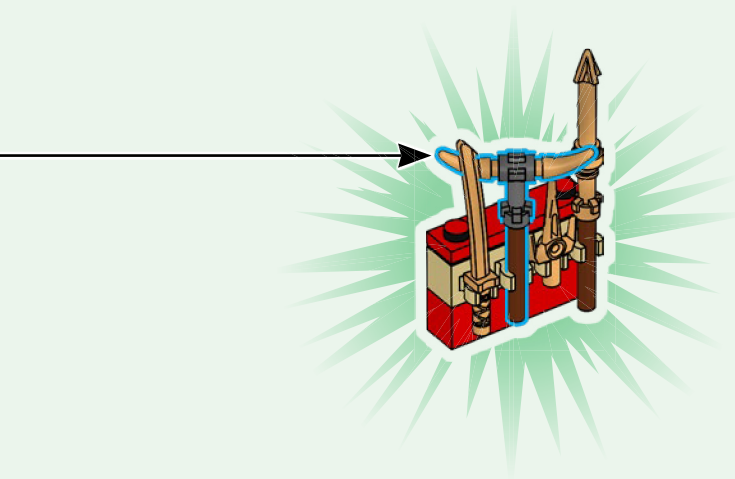

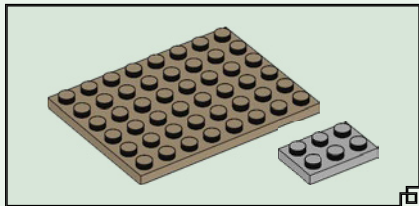
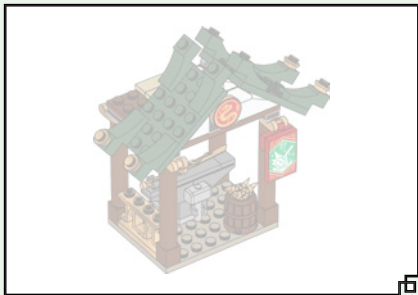

1

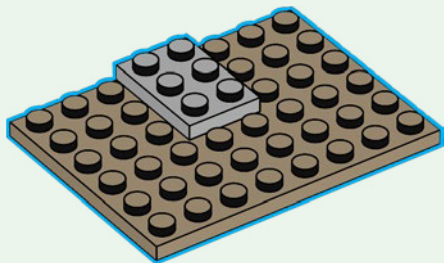

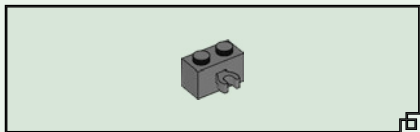

2

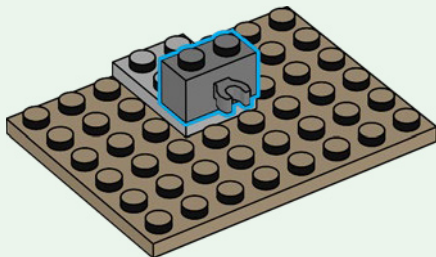

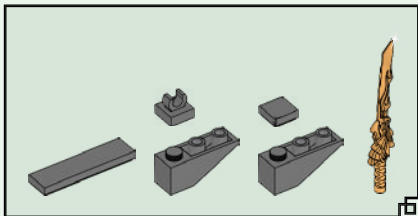

3

1

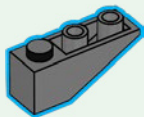

2

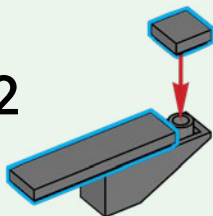

3

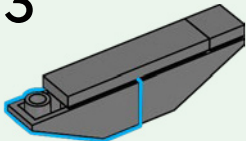

4

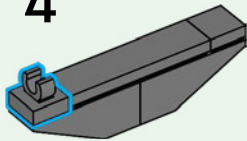

5

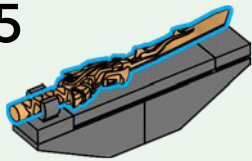

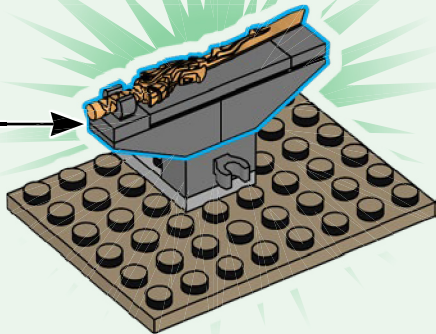

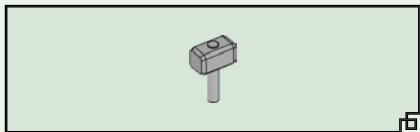

4

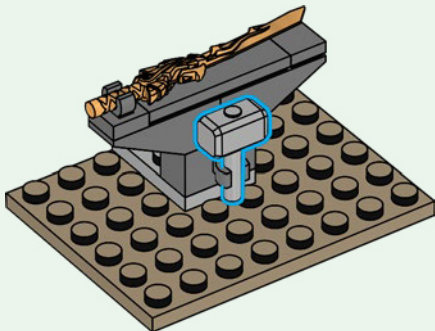

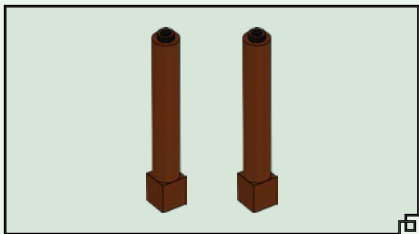

5

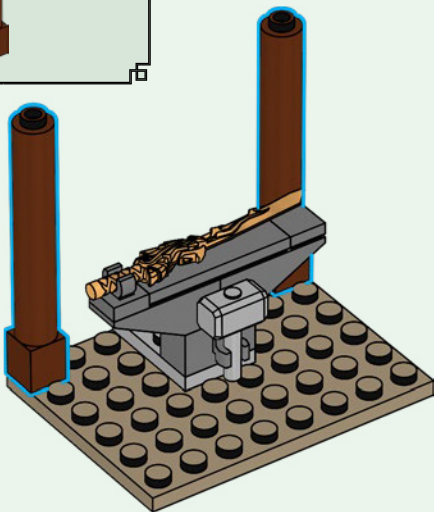

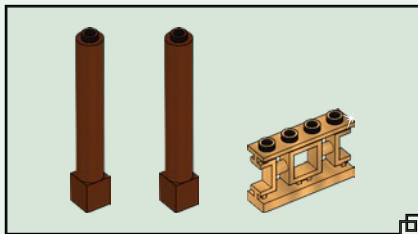

6

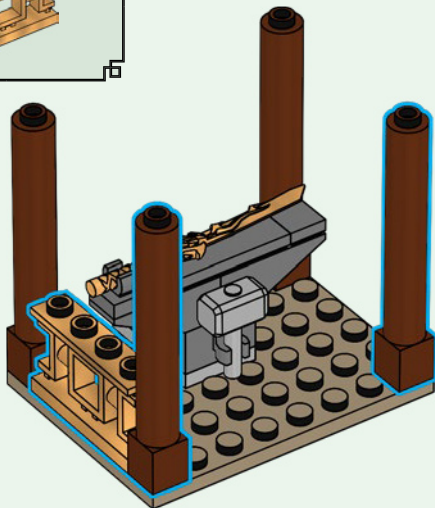

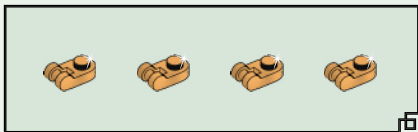

7

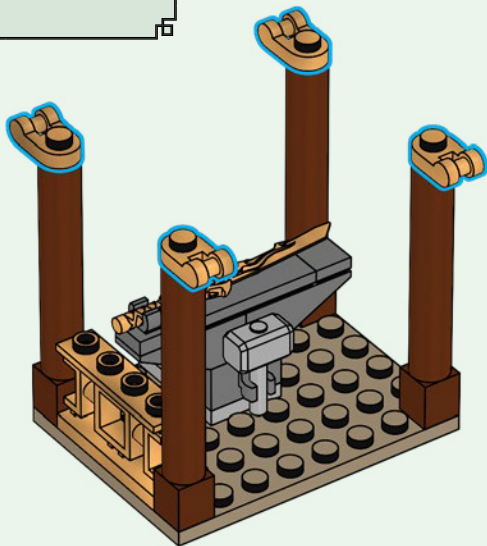

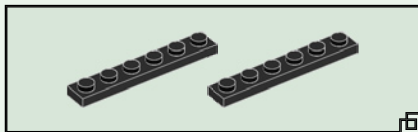

8

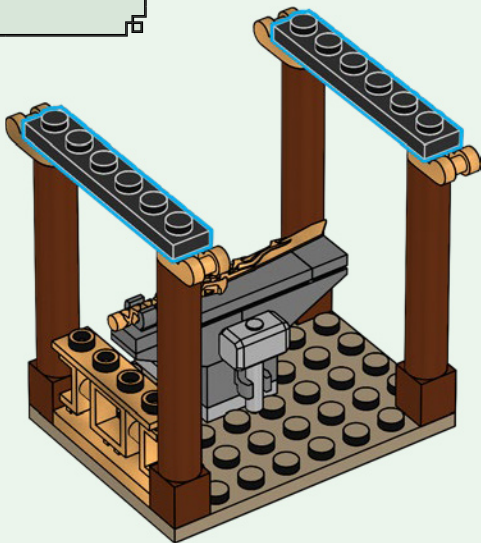



9

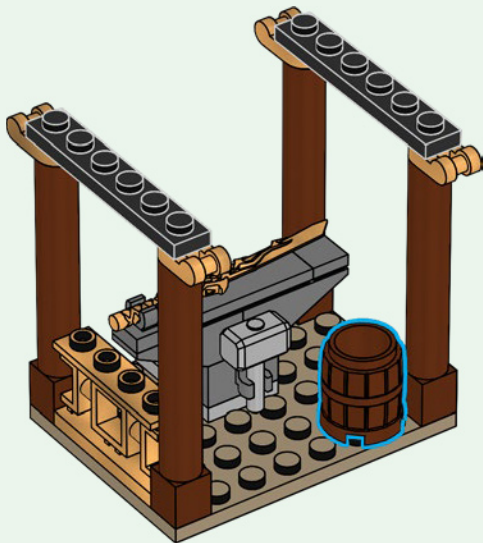

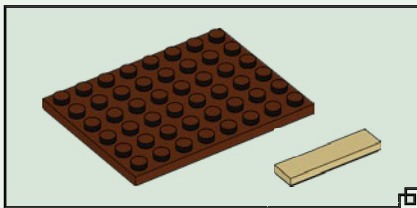

10

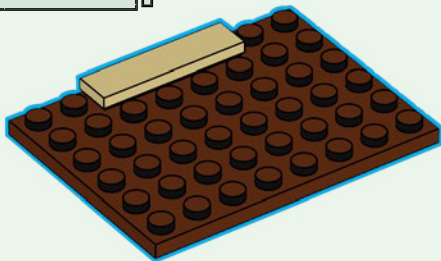

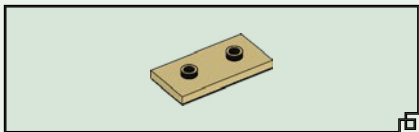

11

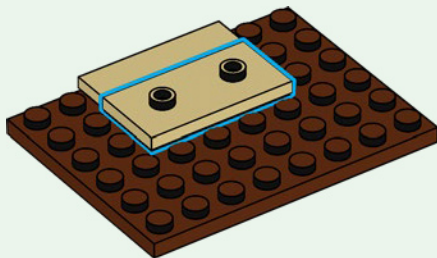

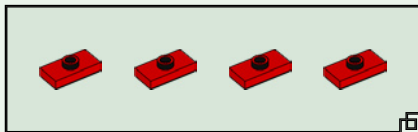

12

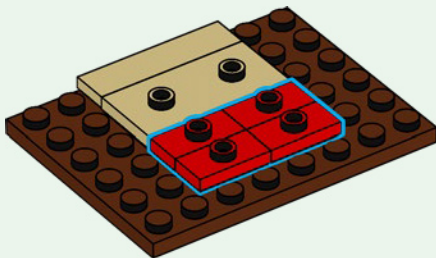

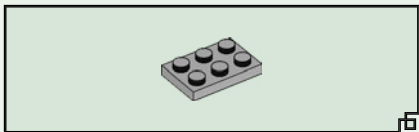

13

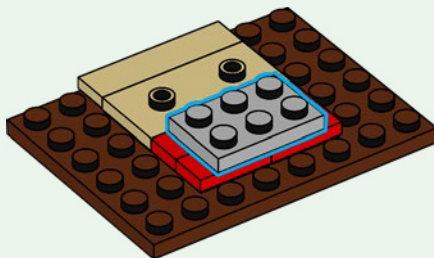

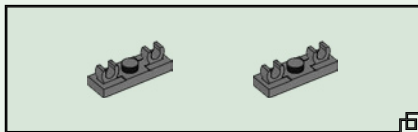

14

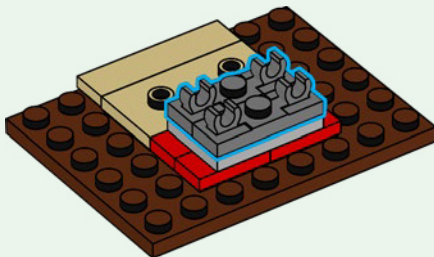

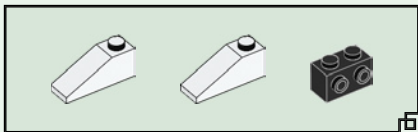

15

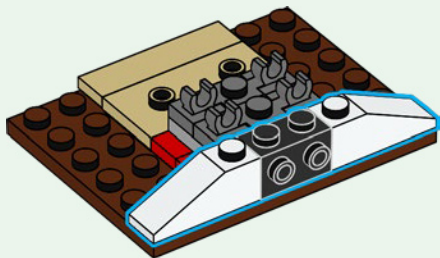

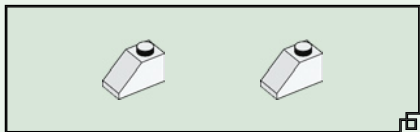

16

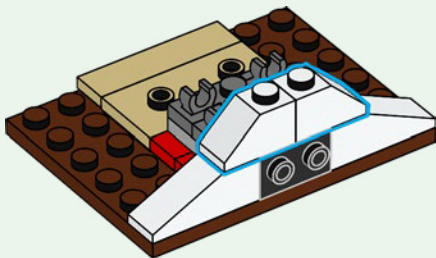

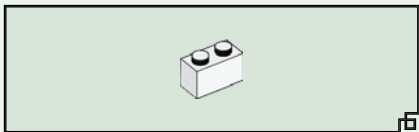

17

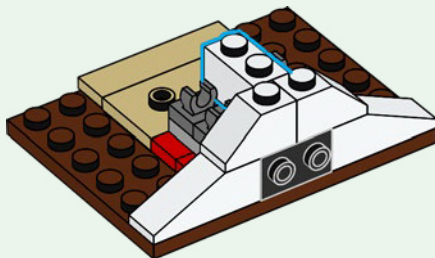

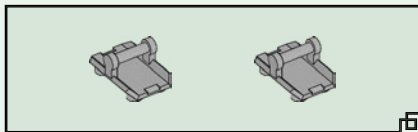

18

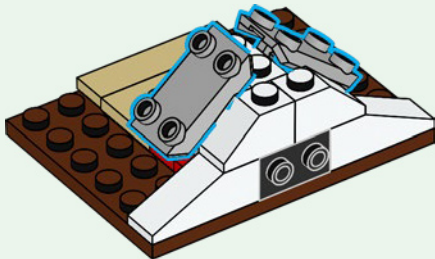



19

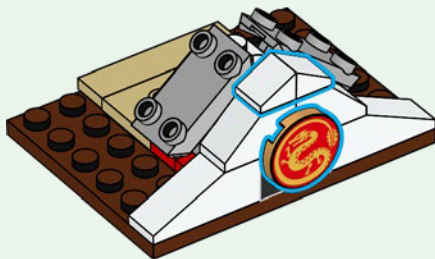

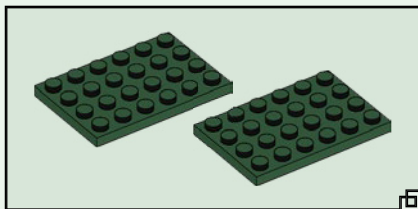
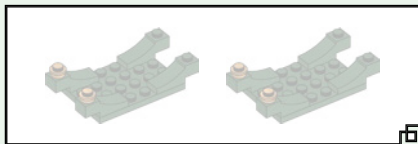

20

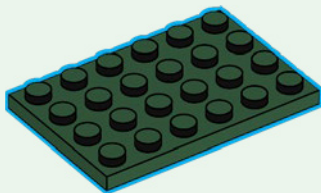
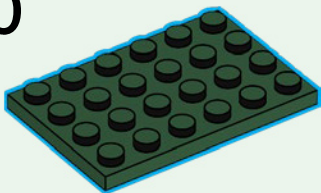

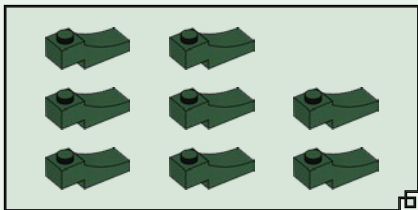

21

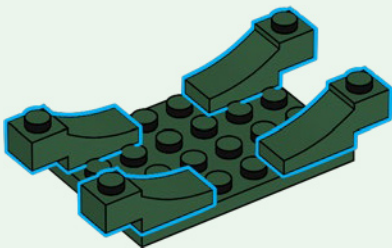
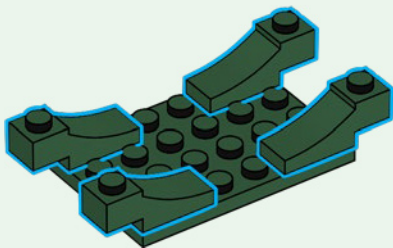



22

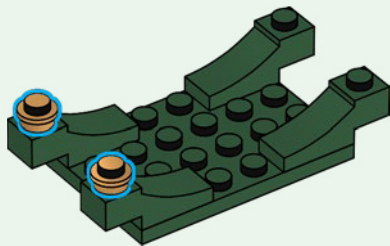
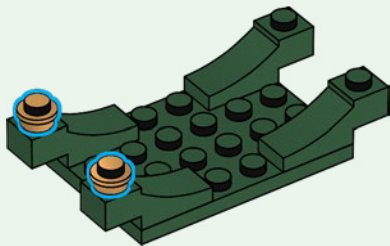

23

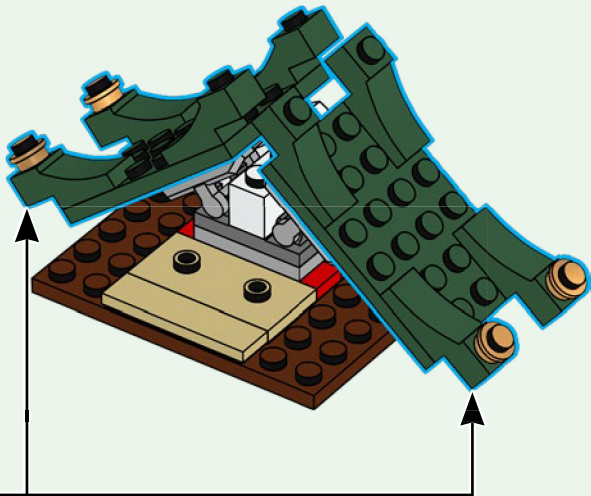

24

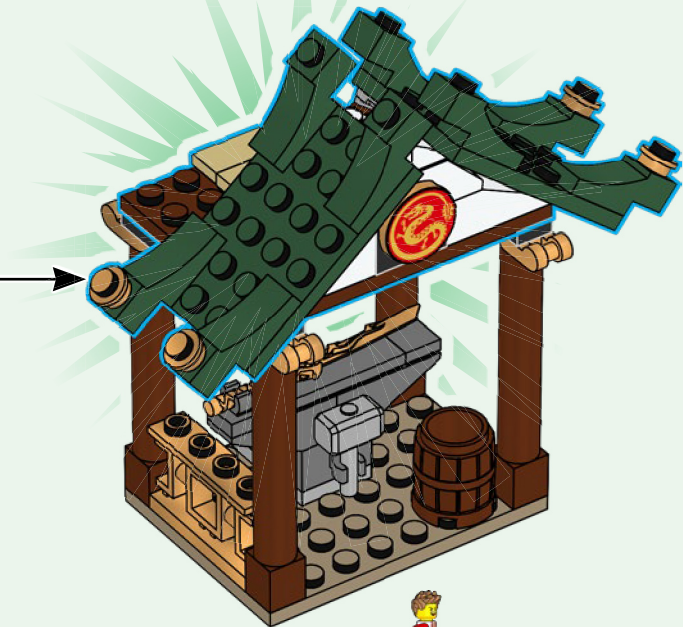

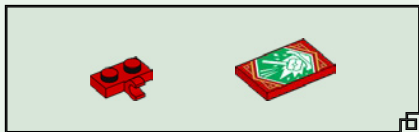

25

1



2







26

1

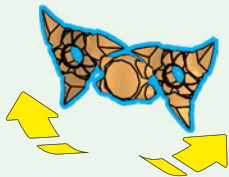

2

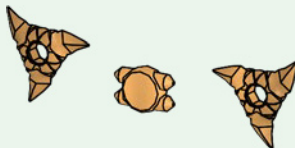

27



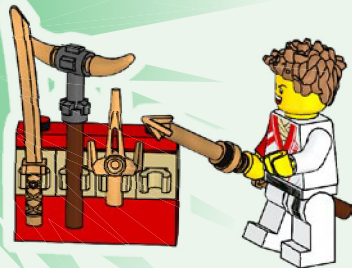

LEGO

NINJAGO



71785



71786



71787



71781



71782



71780



71784



71783



LEGO, the LEGO logo and NINJAGO are trademarks of the LEGO Group. ©2023 The LEGO Group. 6449681