

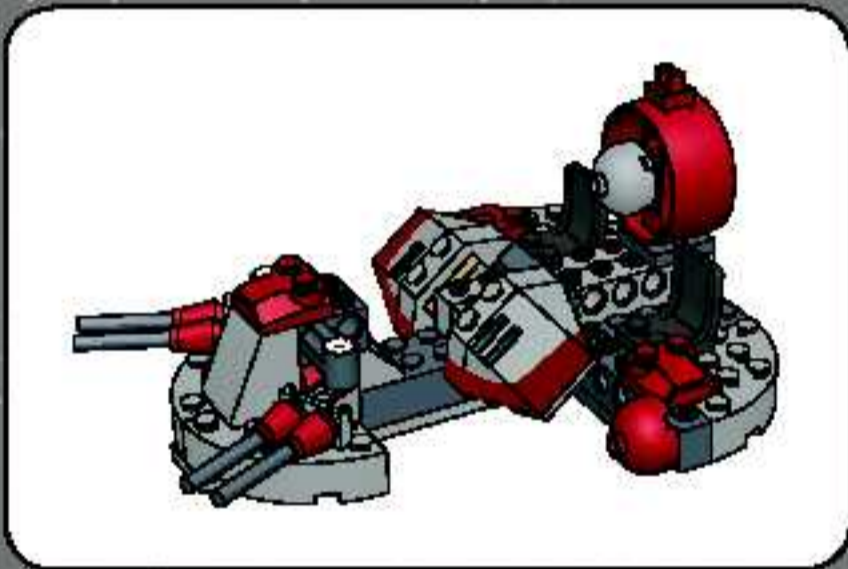

# STAR WARS

7260

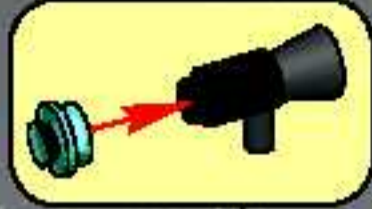



US: When no longer in use, please dispose of the element in an environmentally responsible manner.  
 CA: Lorsque l'élément est hors d'usage, veuillez s.v.p. le jeter d'une manière responsable sans nuire à l'environnement.  
 MX: Antes de arrojar a la basura, cuide las normas ambientales.

1

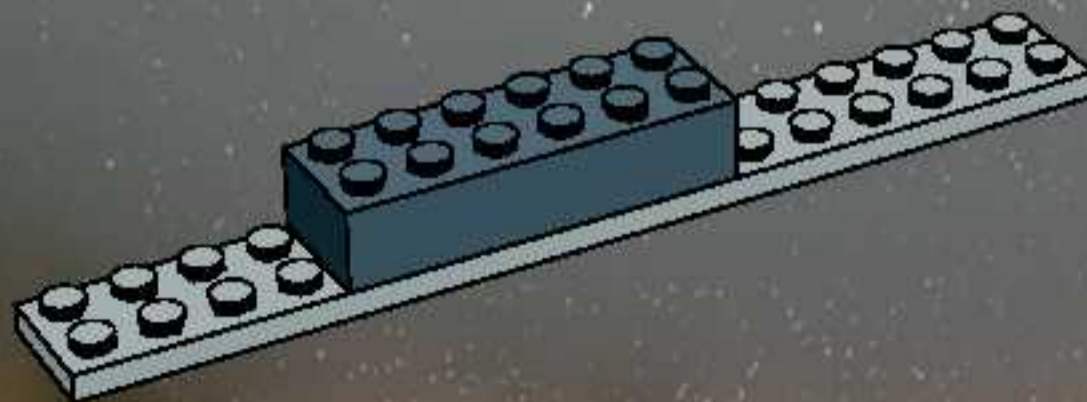

2

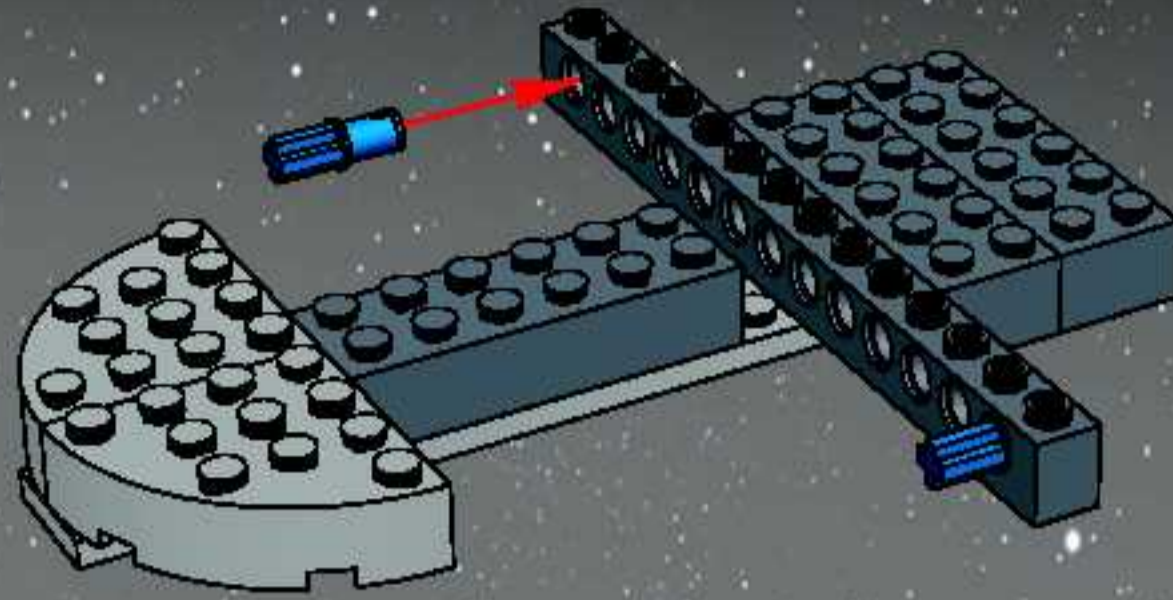

3

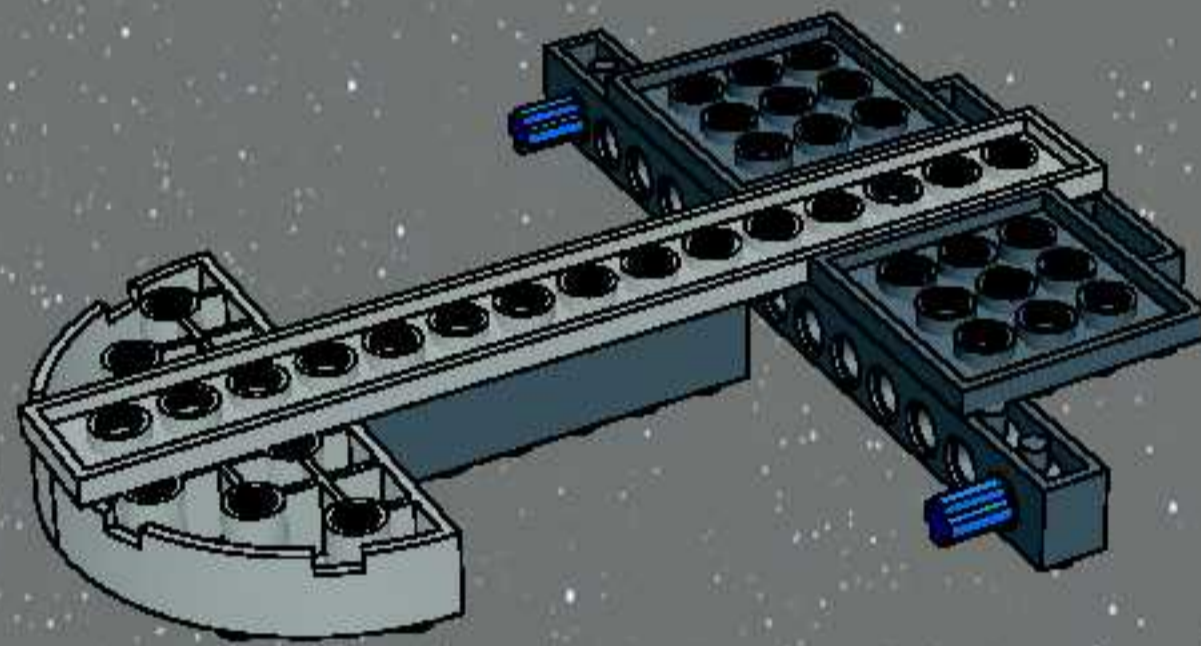

4

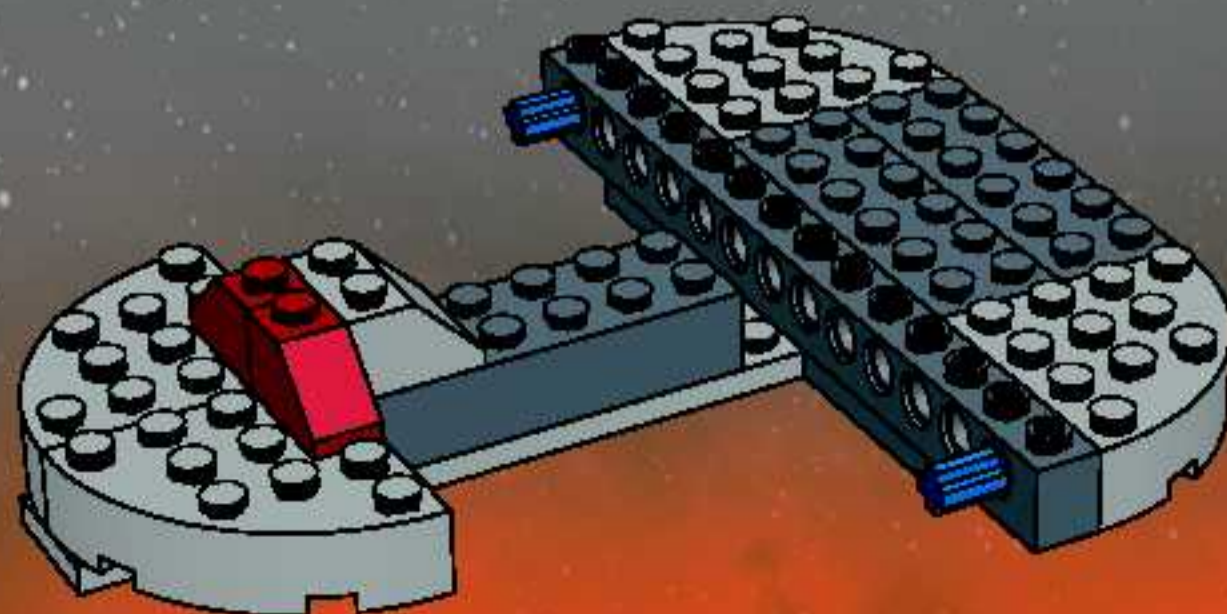

5

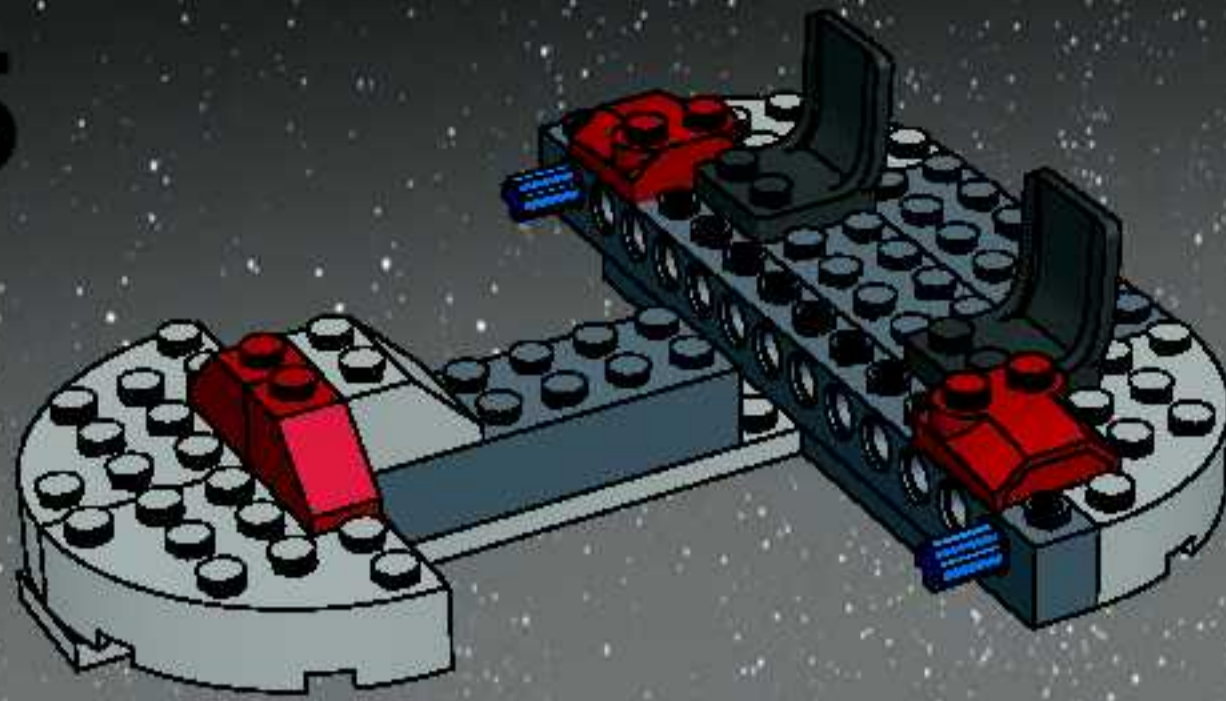

6

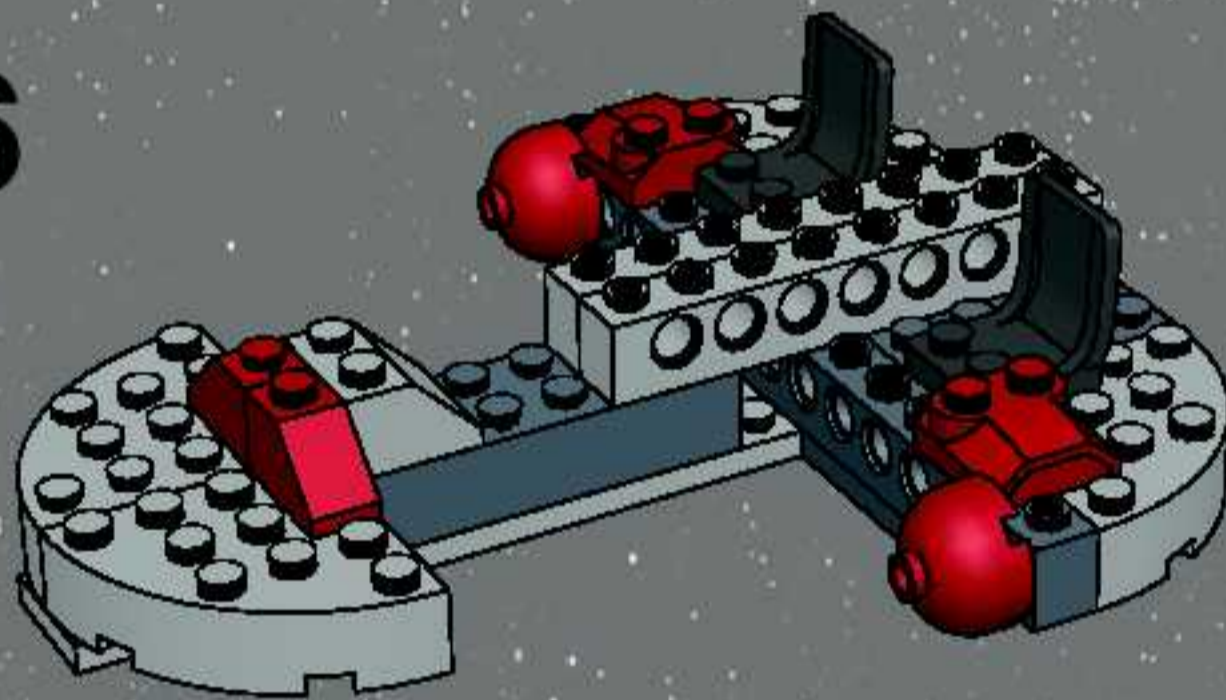

7

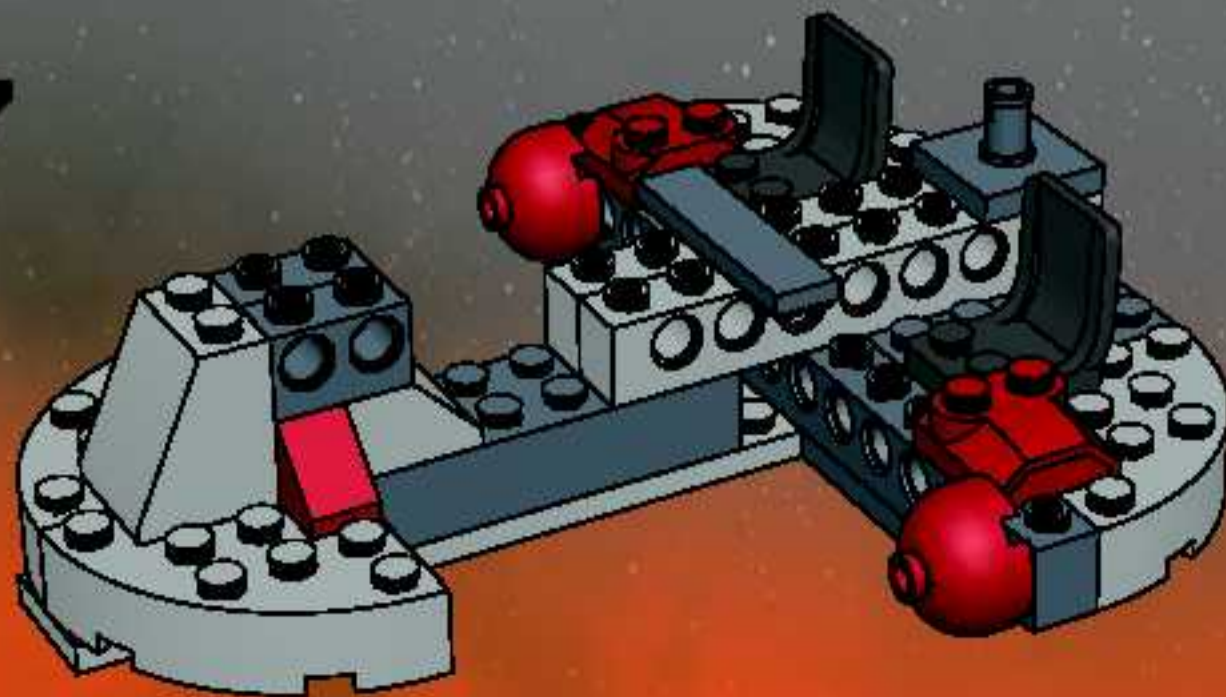

8

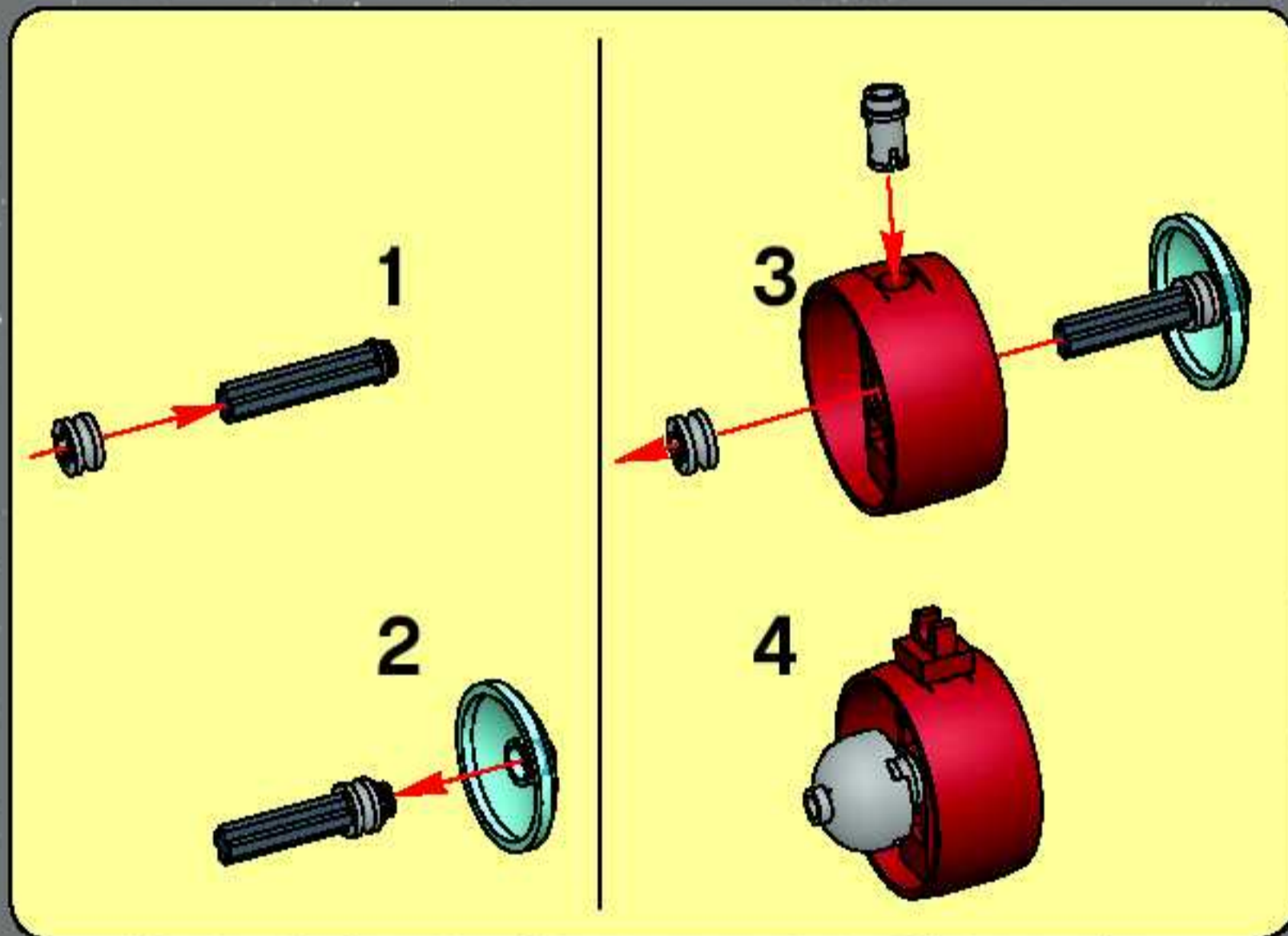
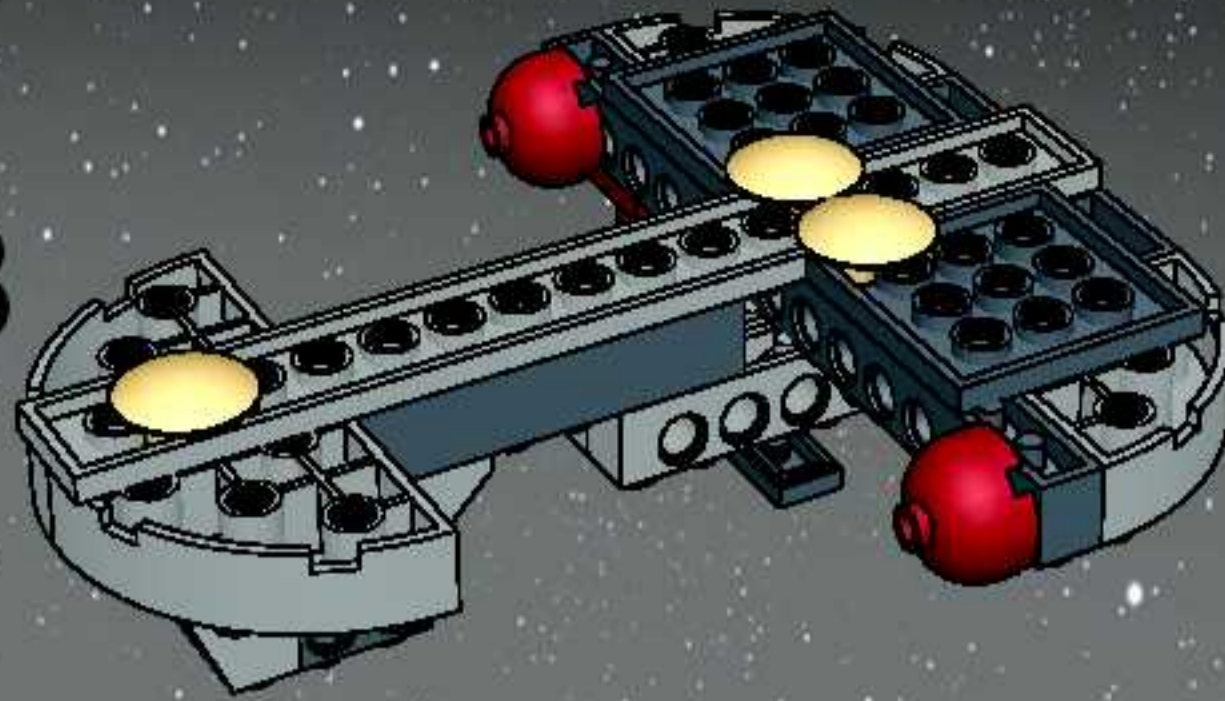

9

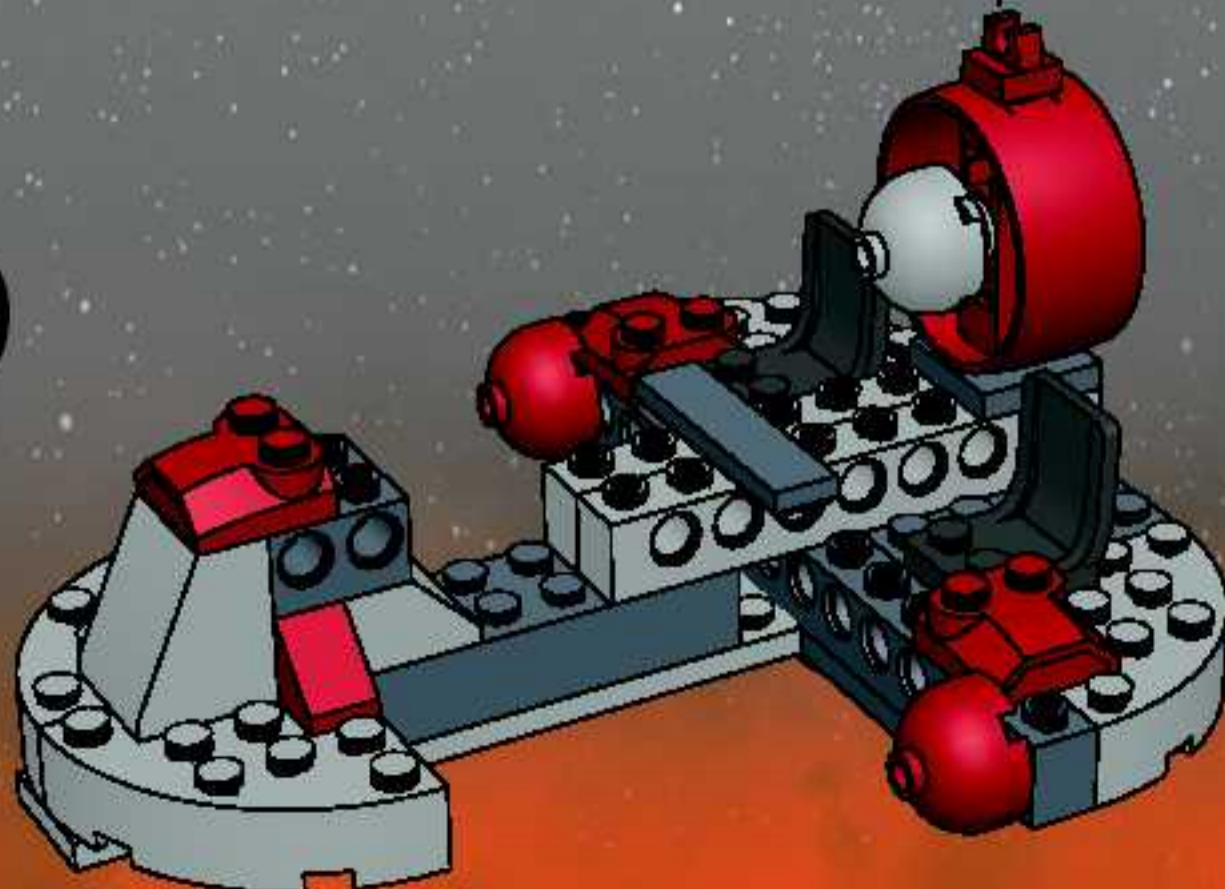

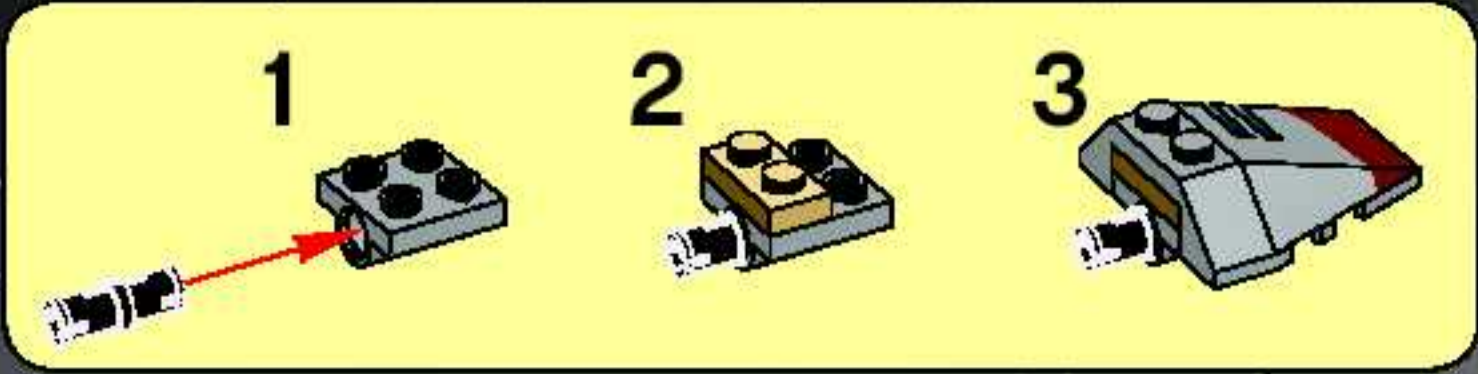

10

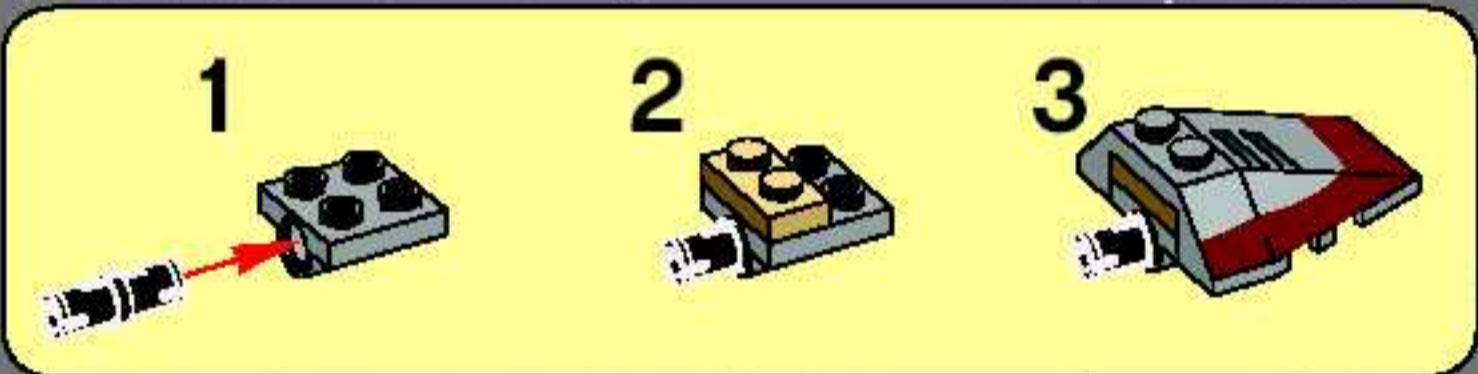
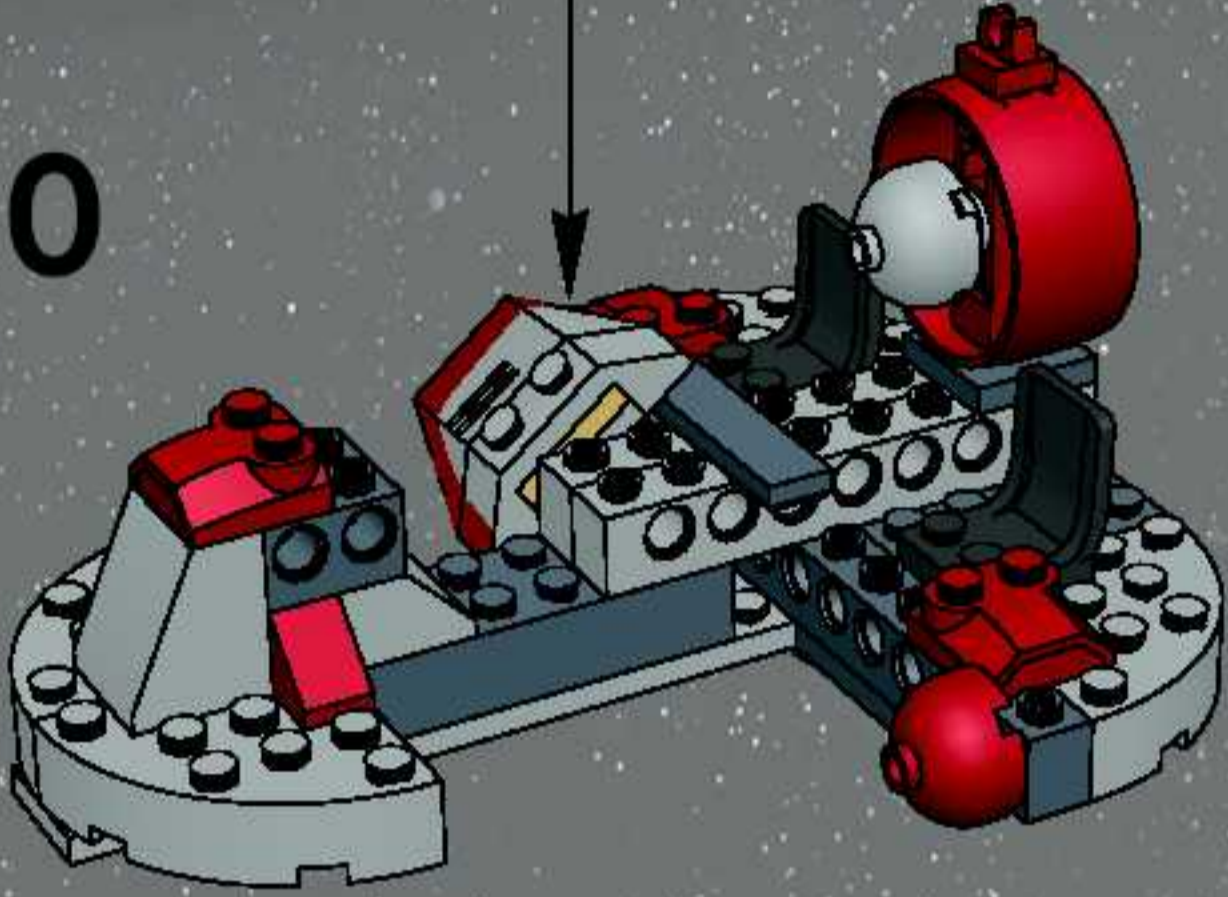

11

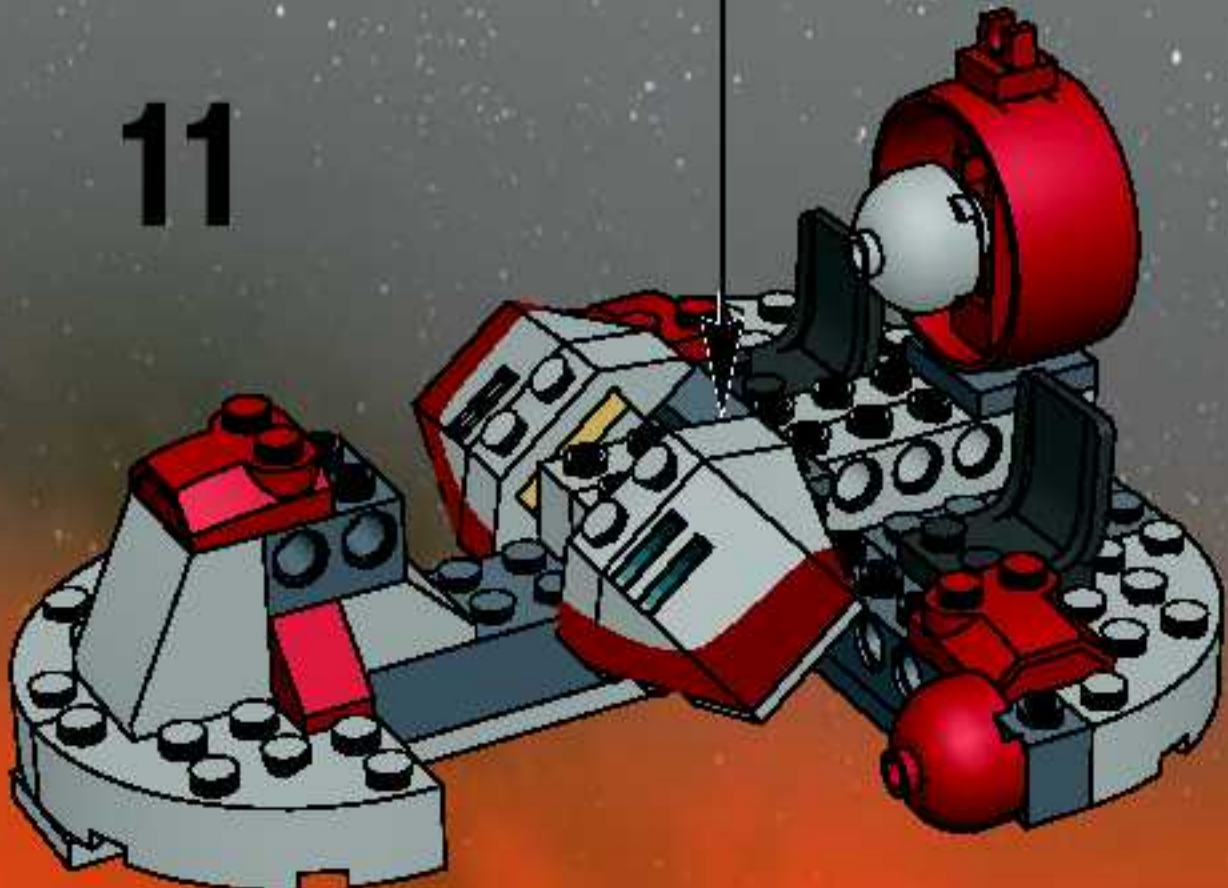

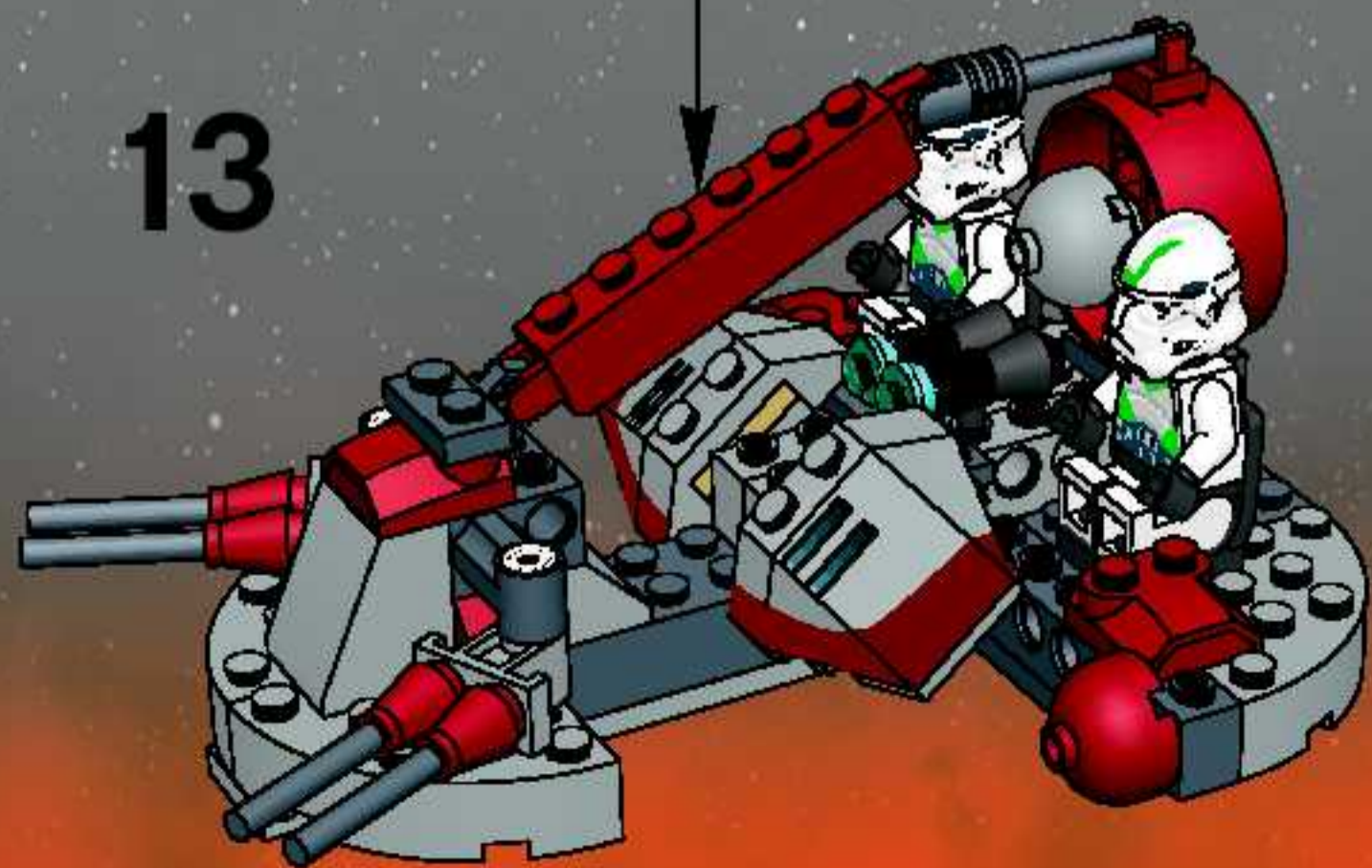
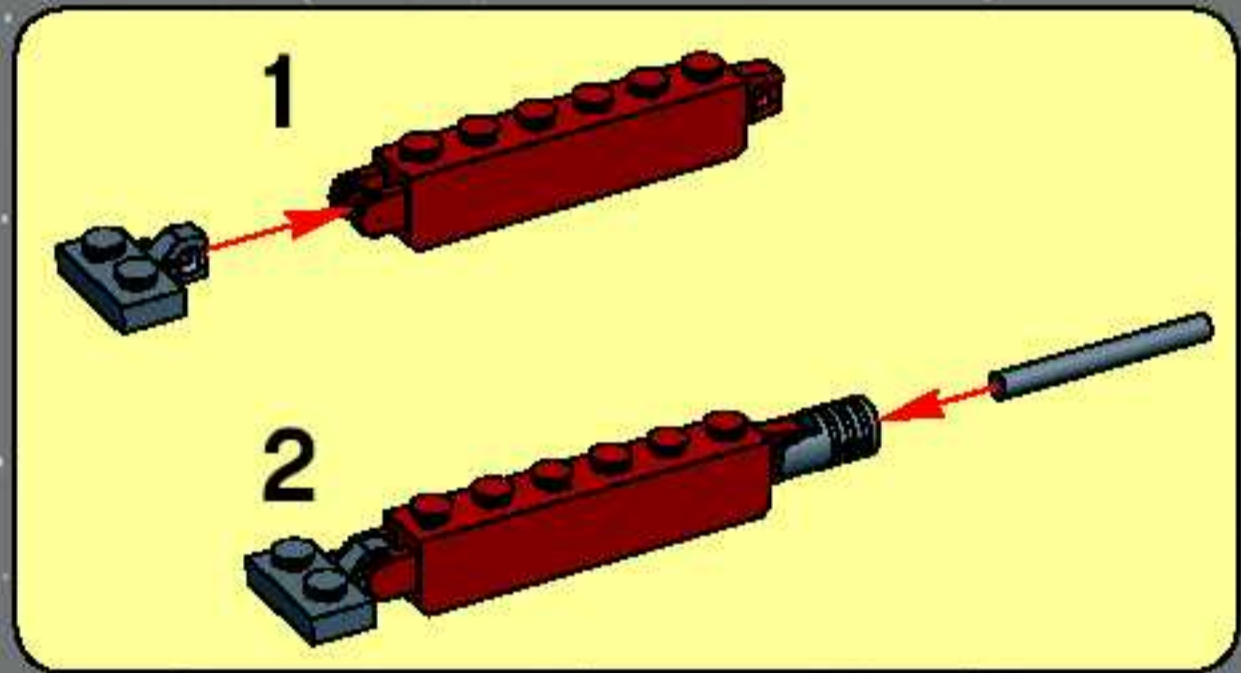
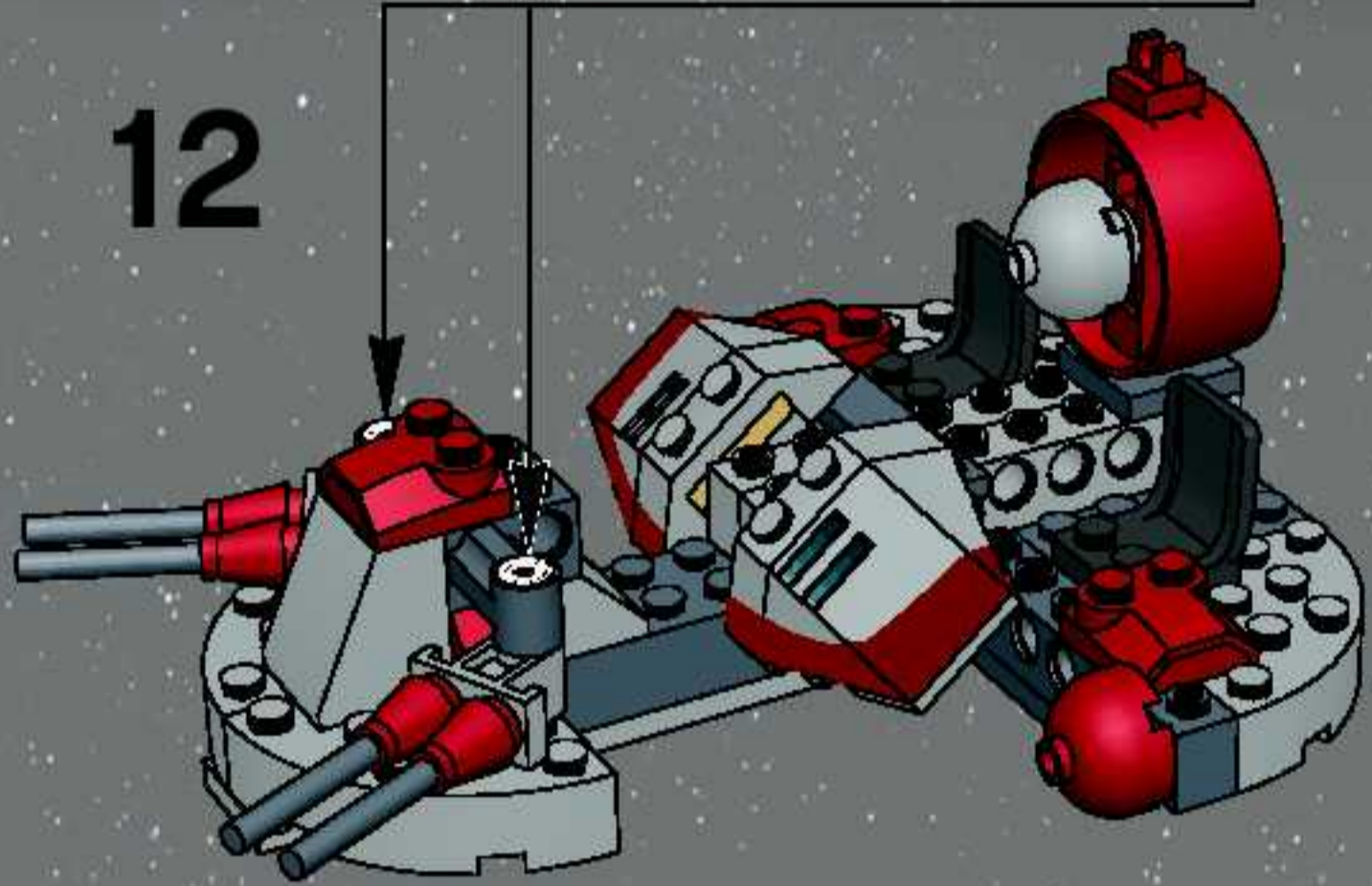
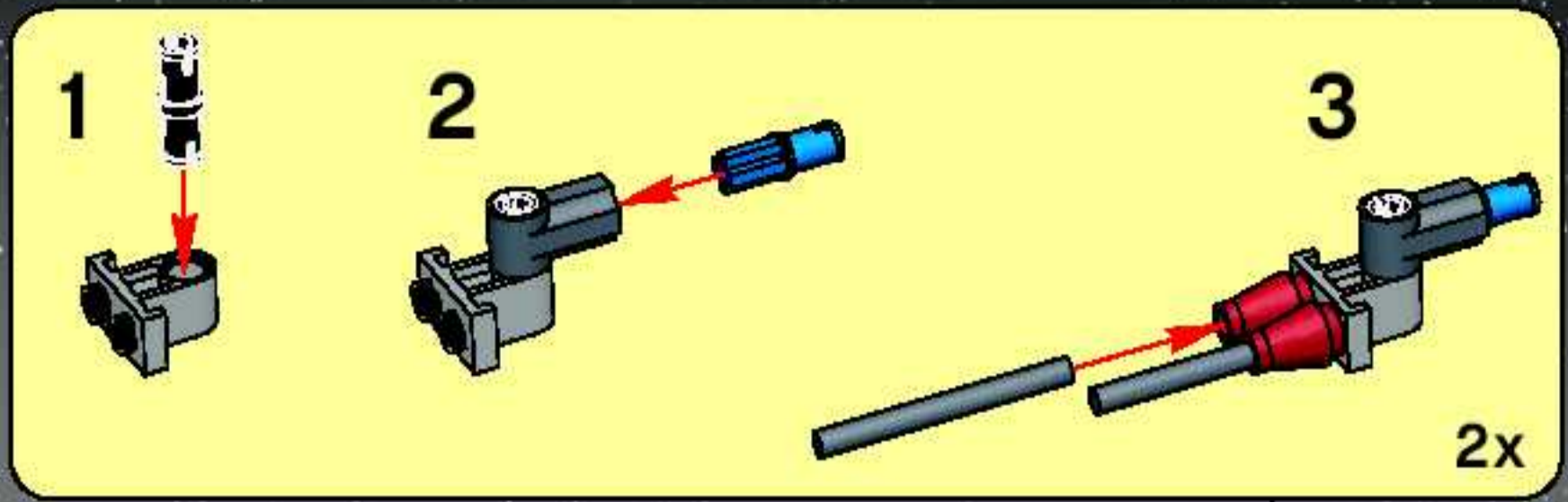

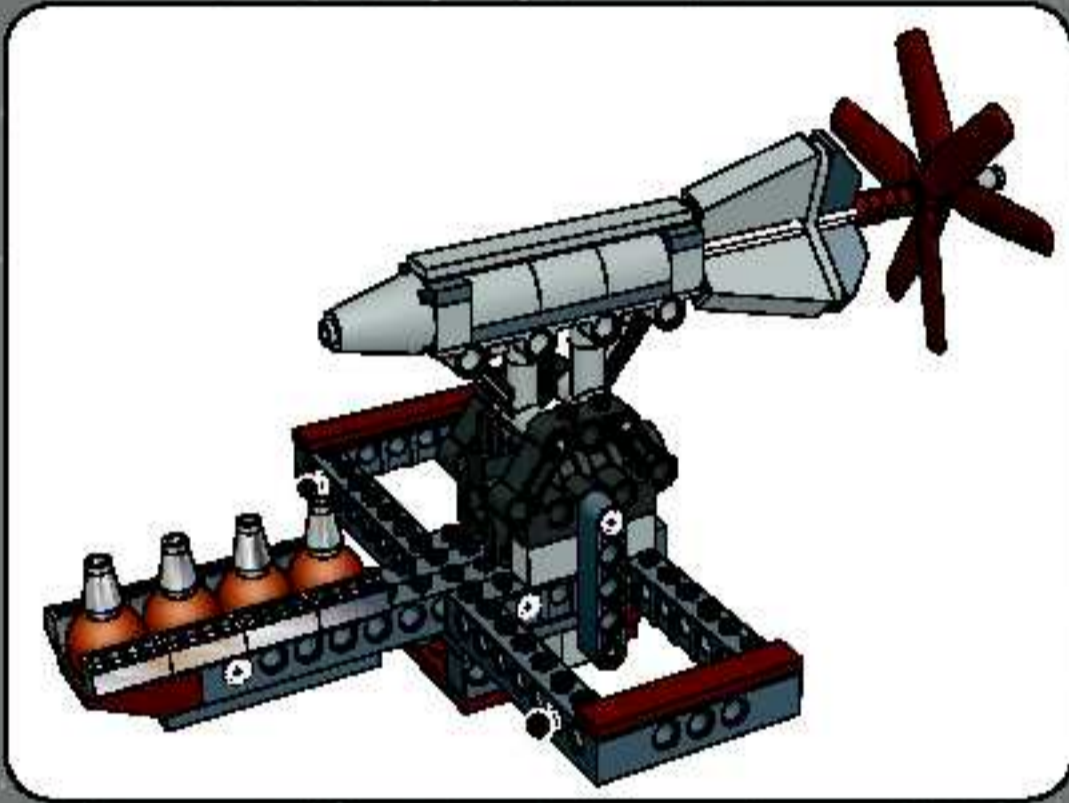
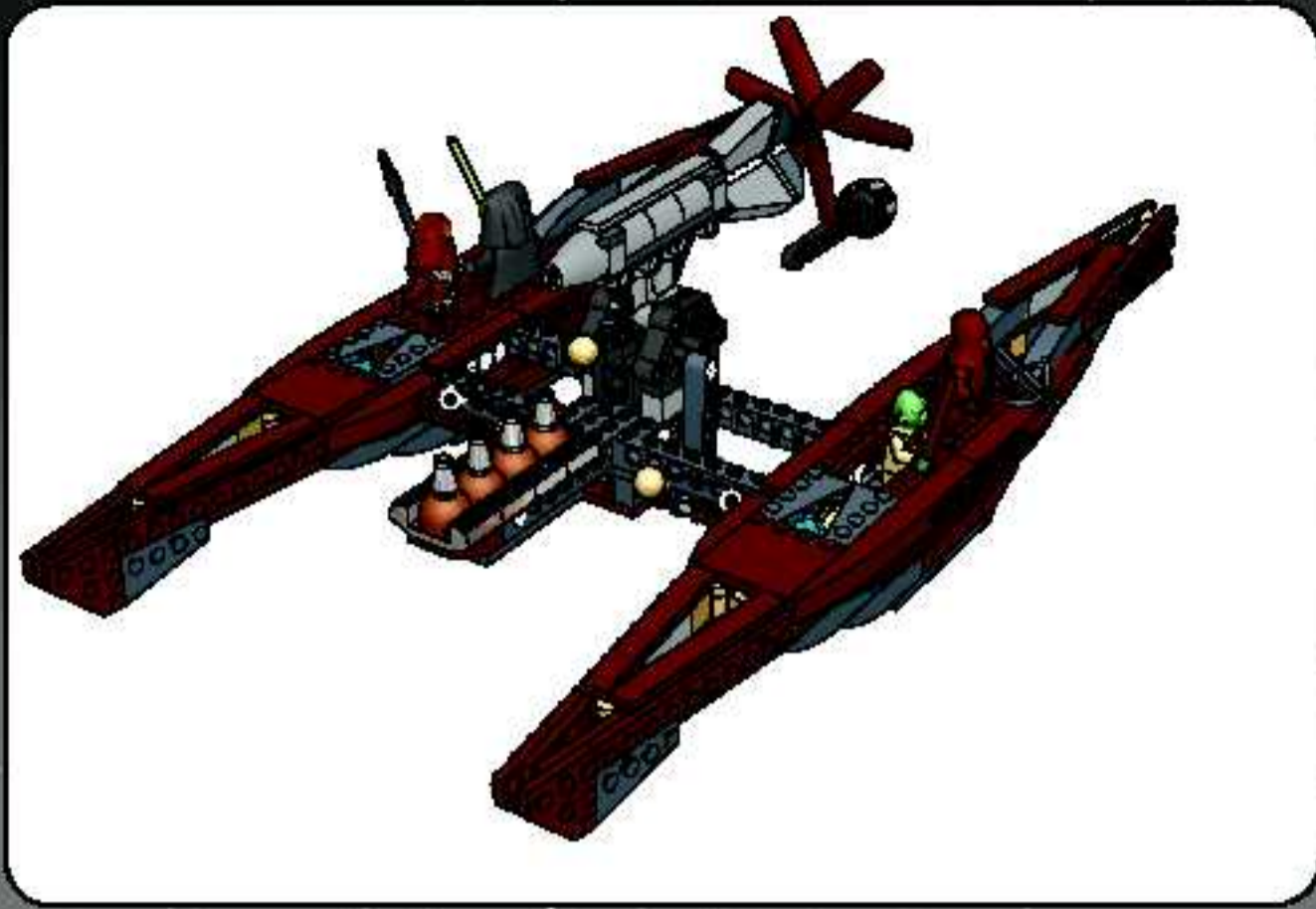

1

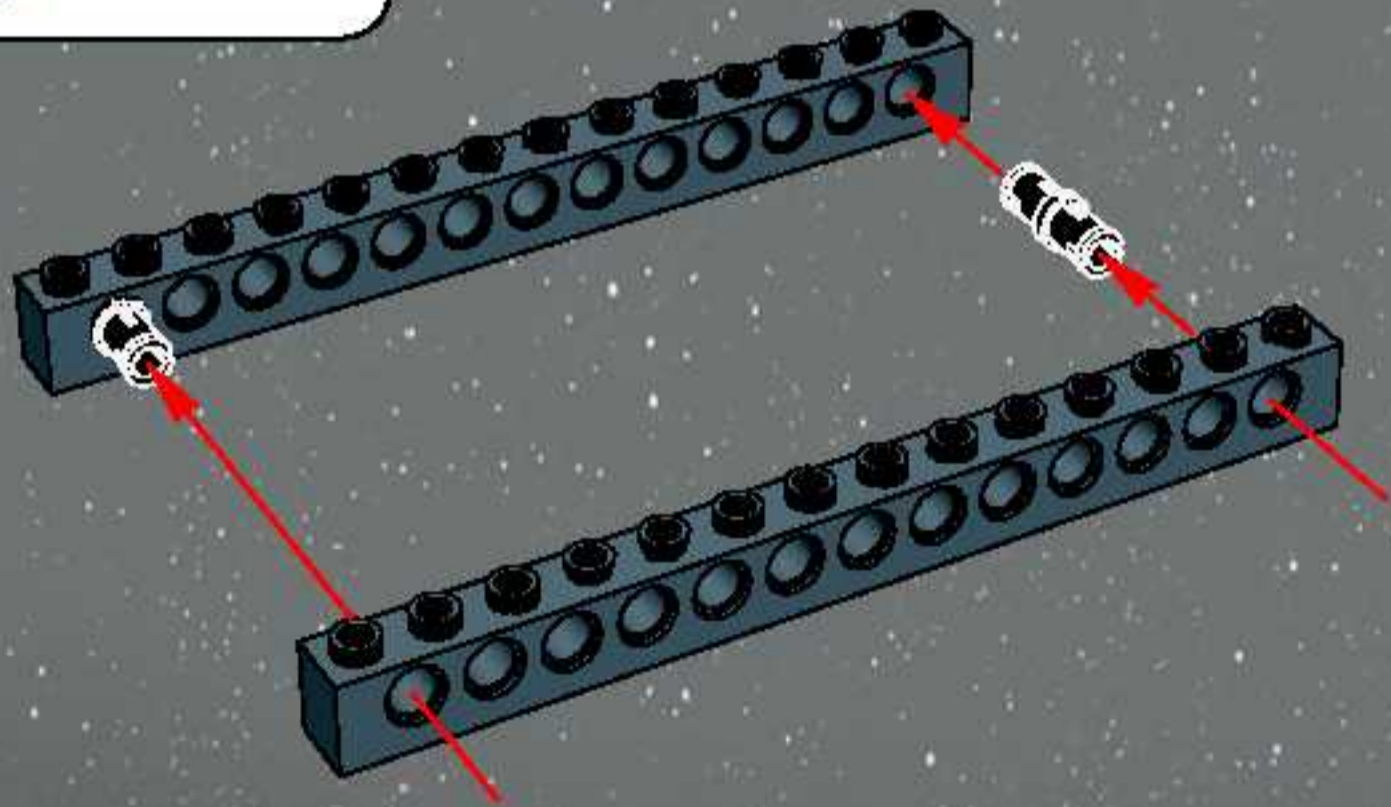

2

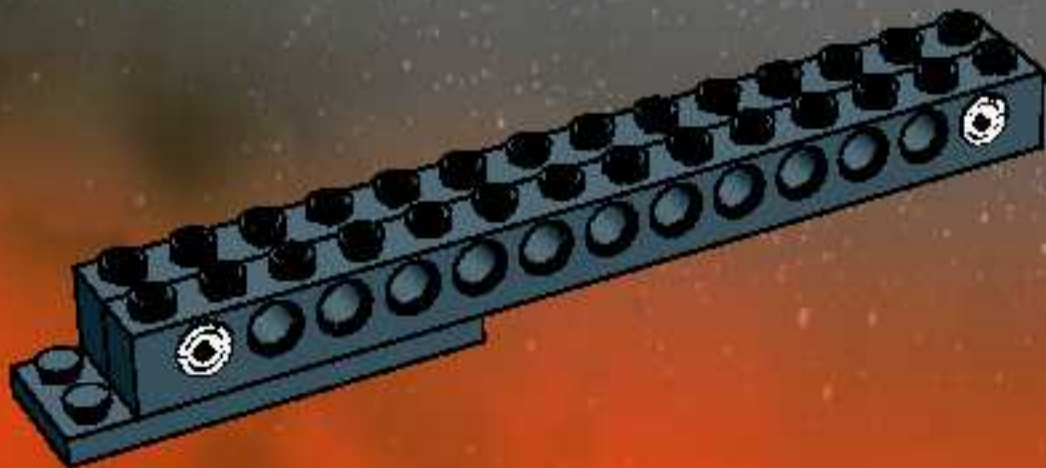



3

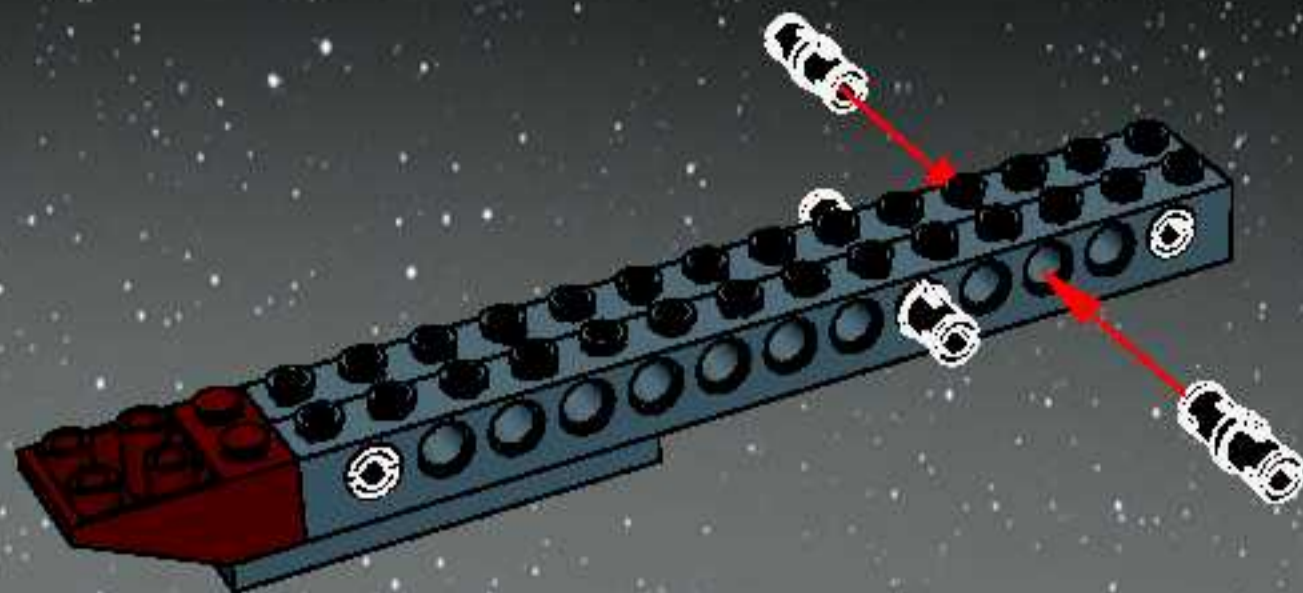

4

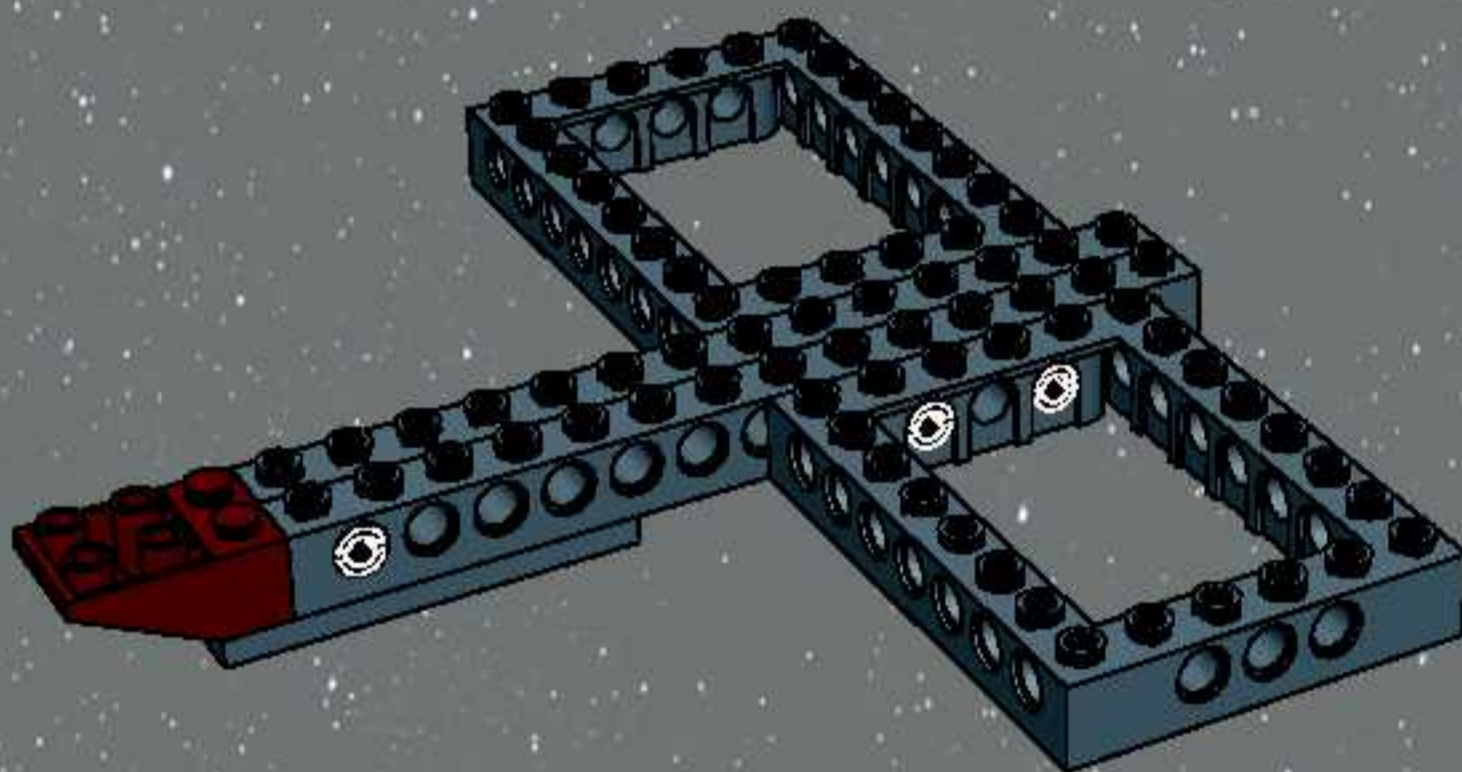

5

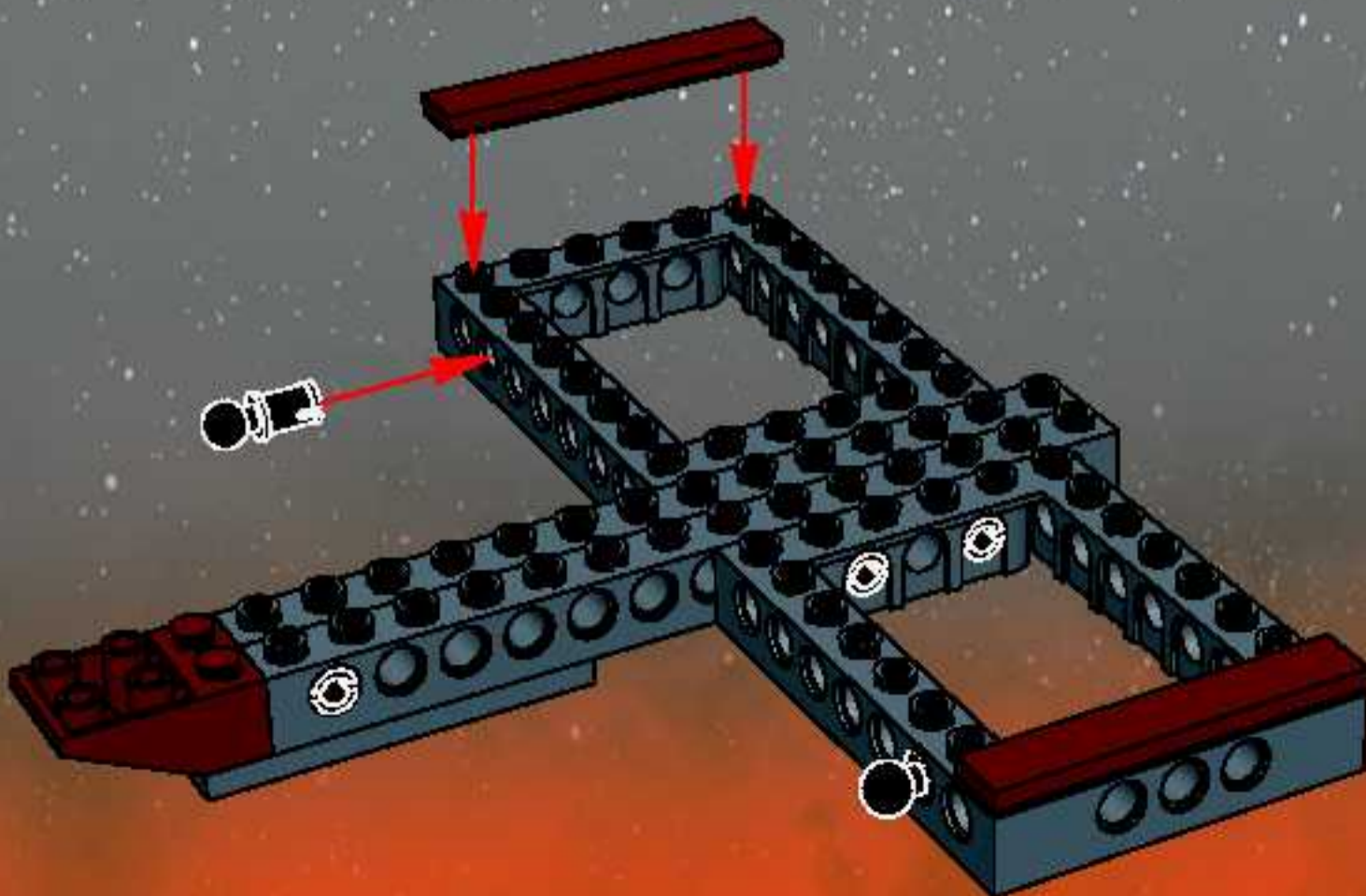

1

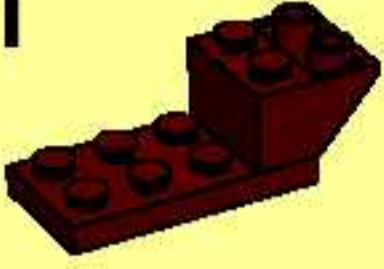

3

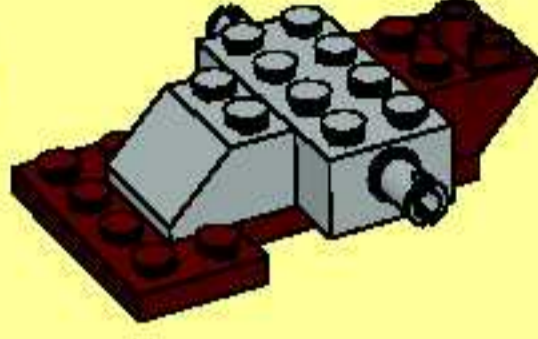

2

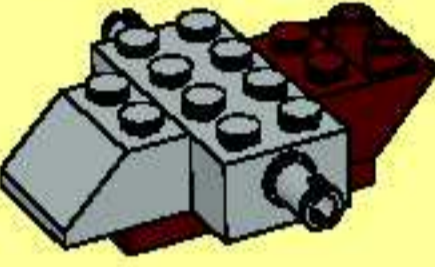

4

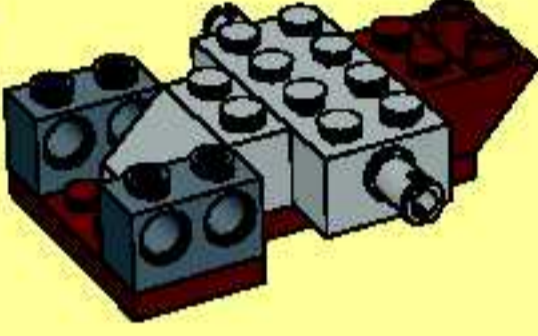

5



6

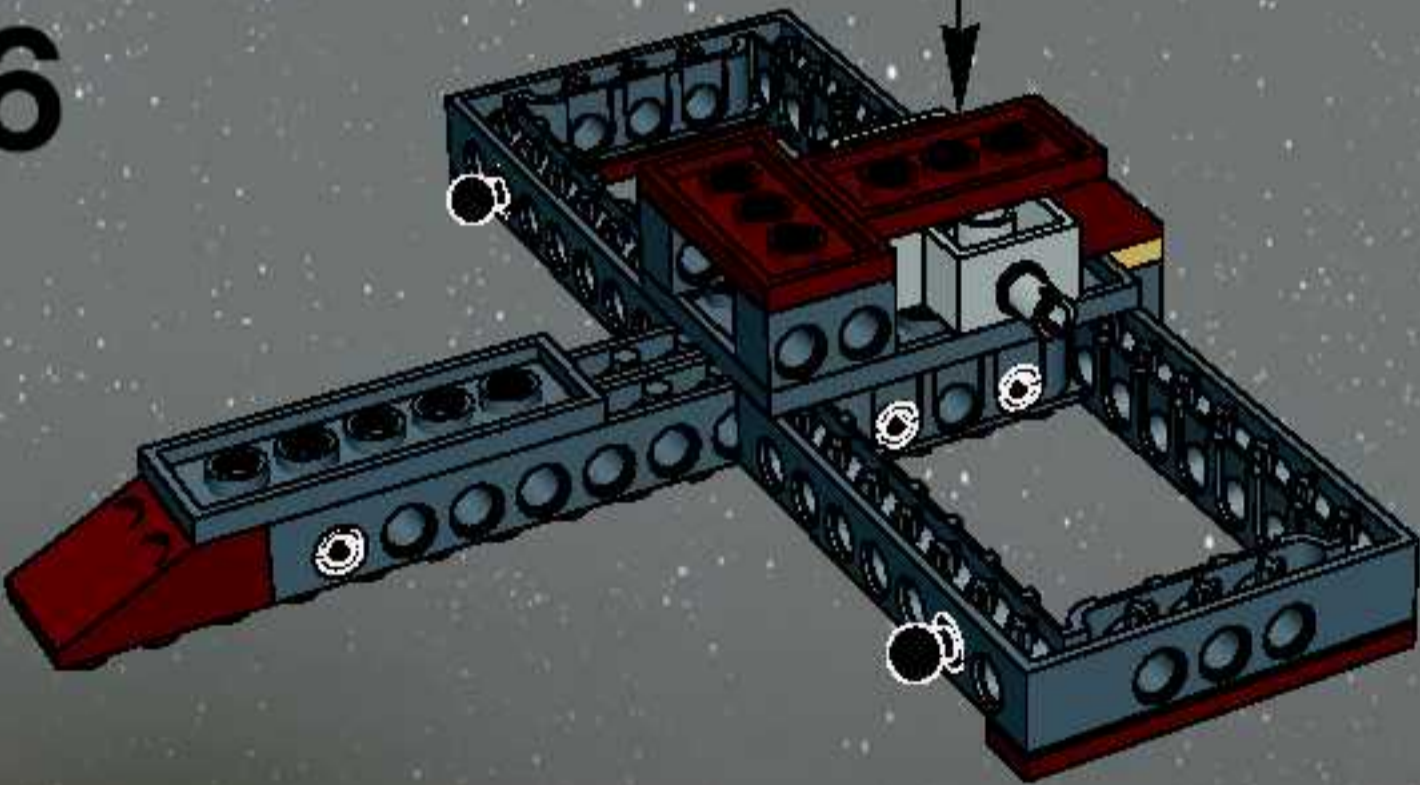



7

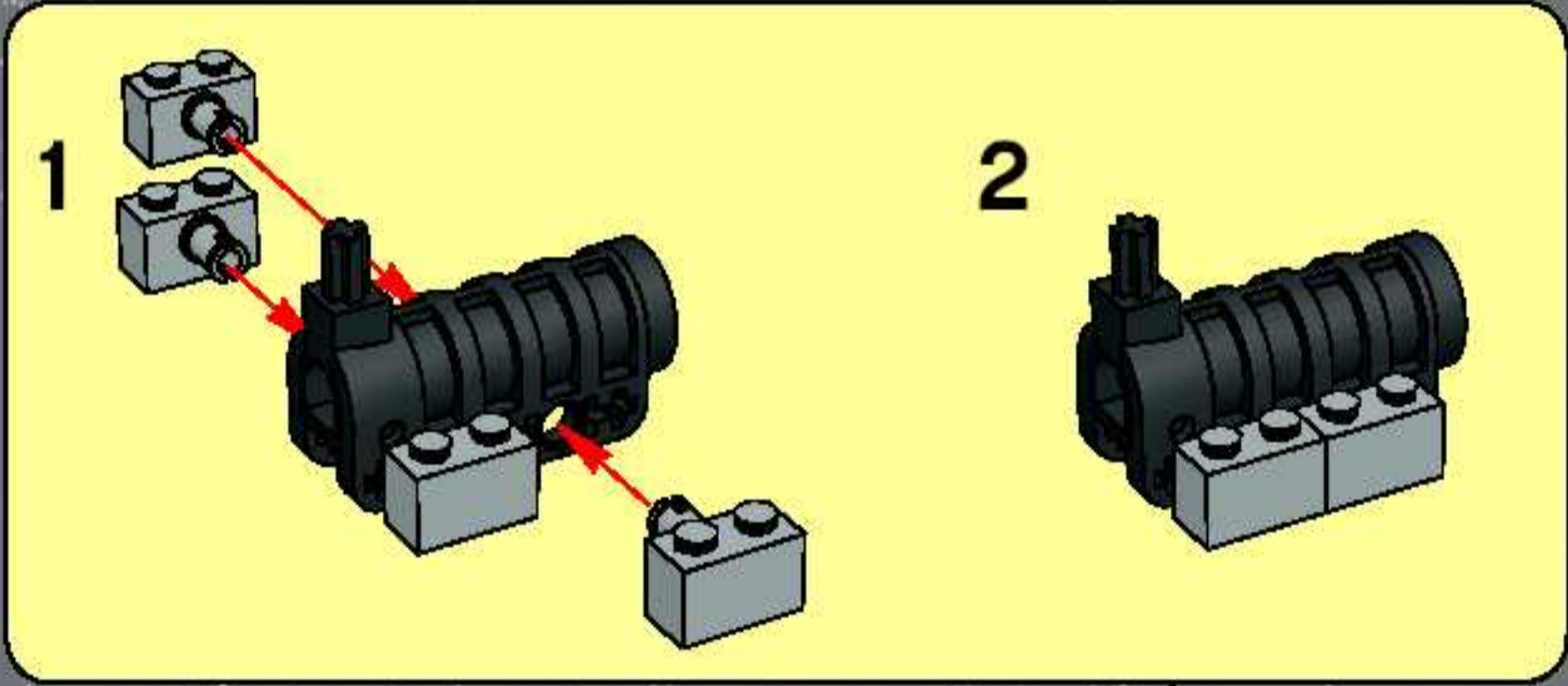
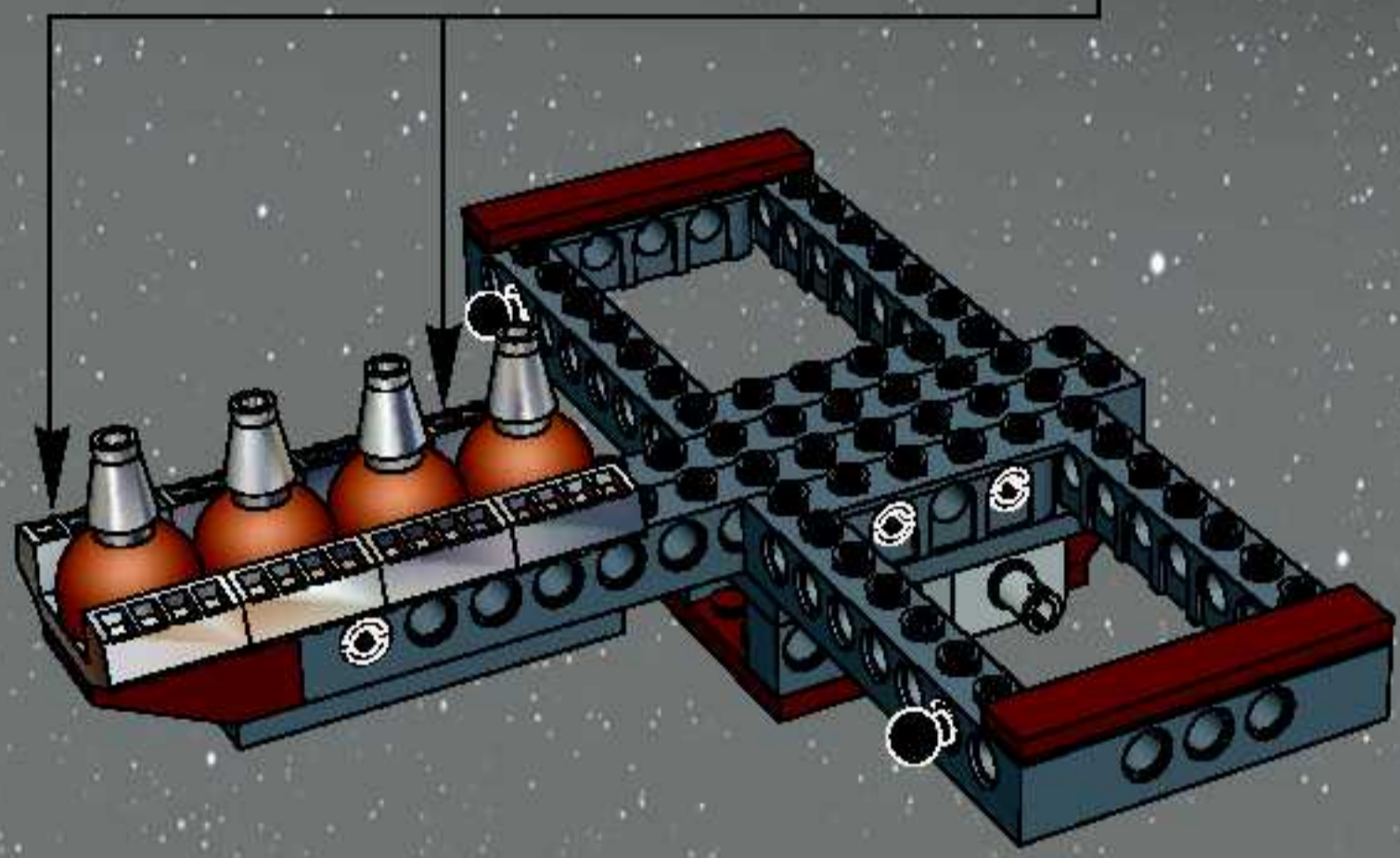

8

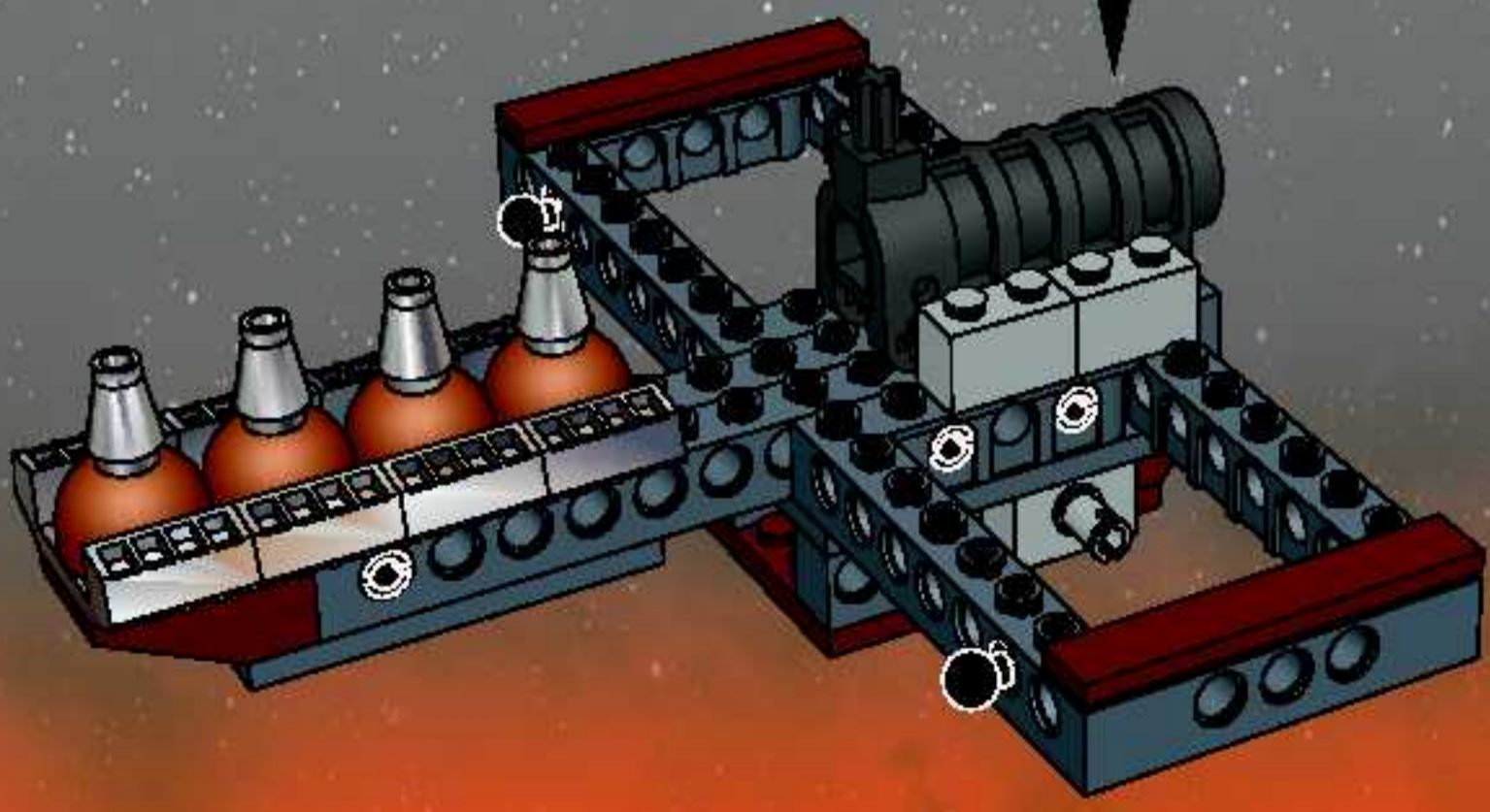

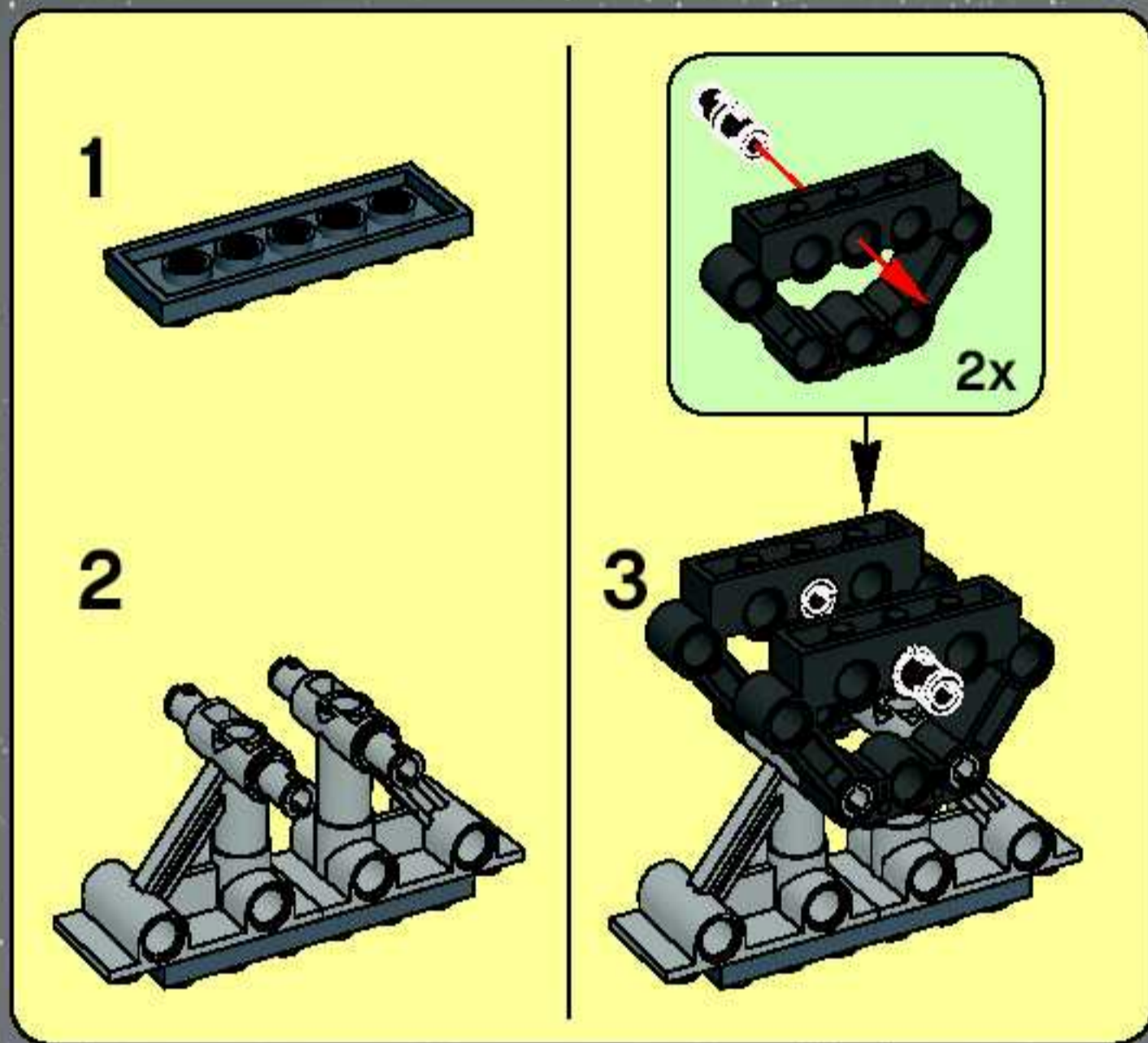

9

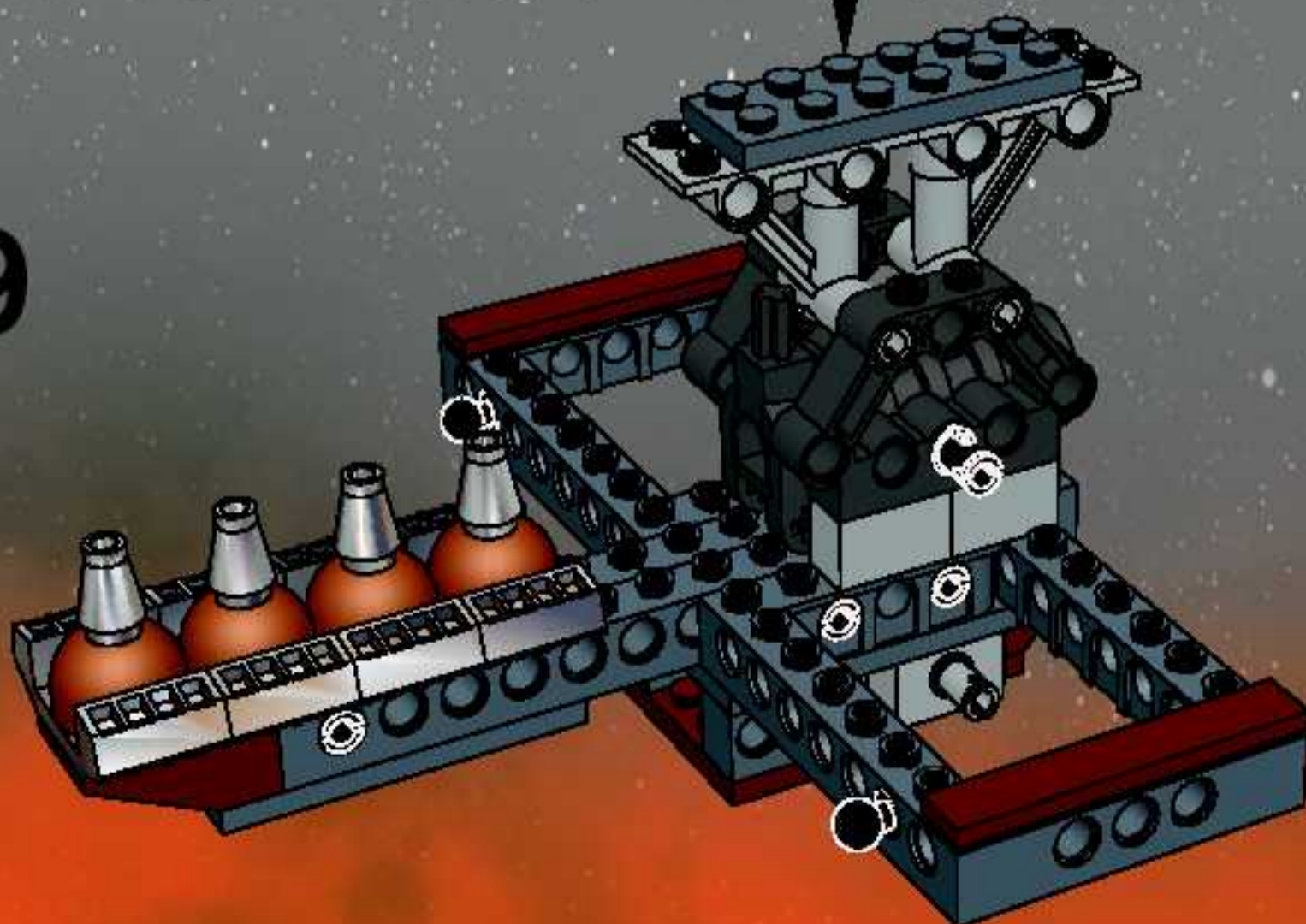

10

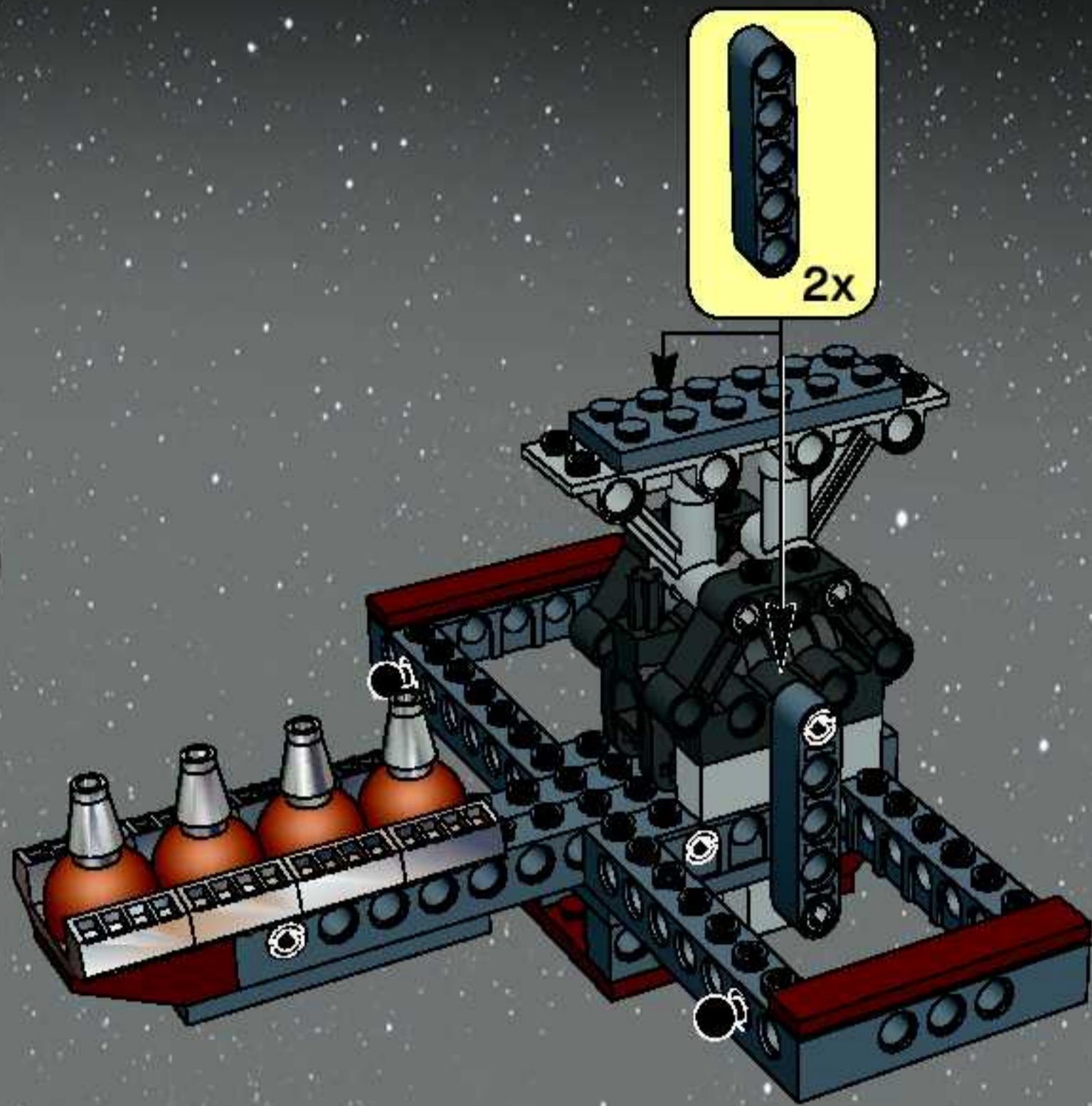

11

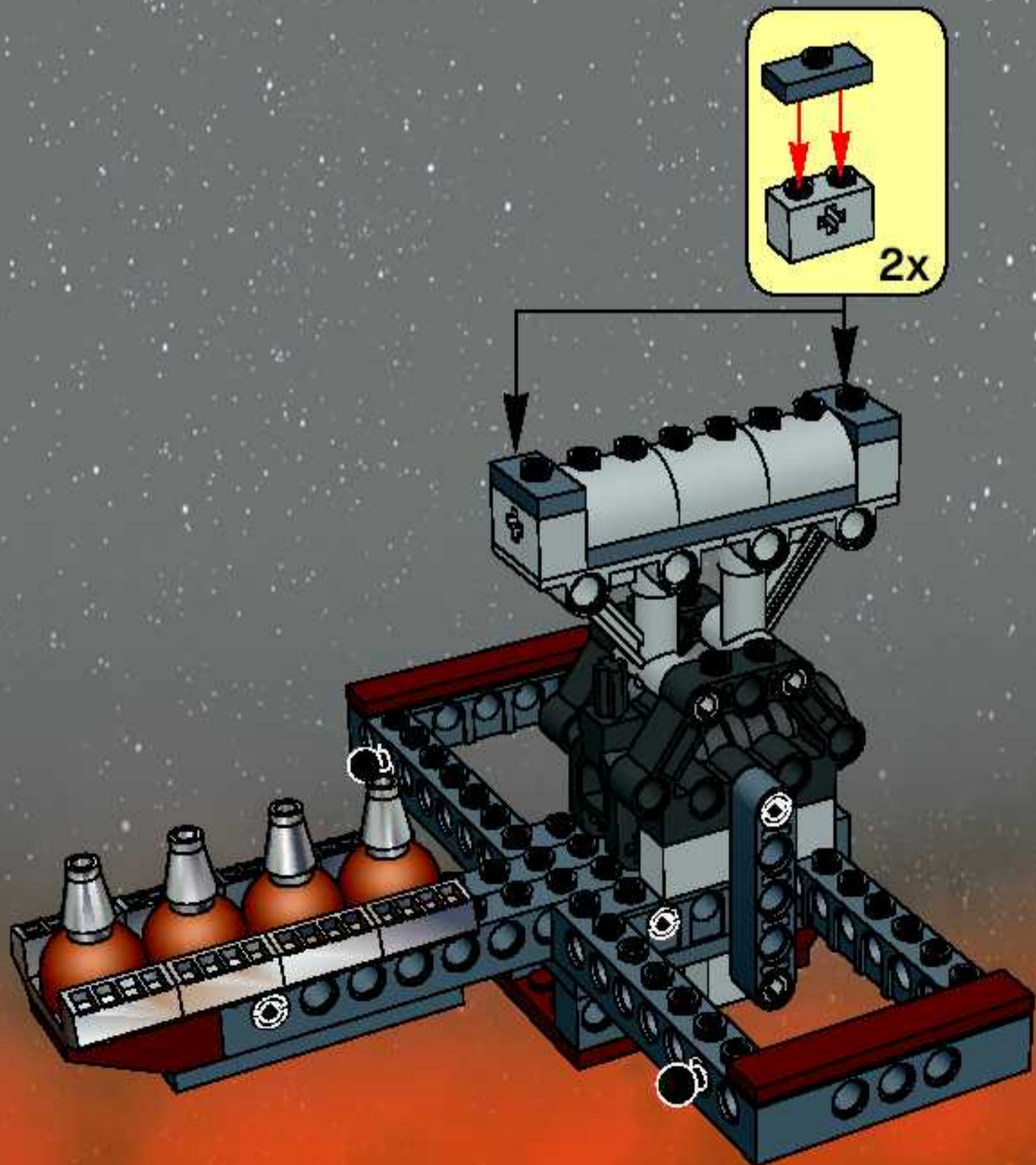

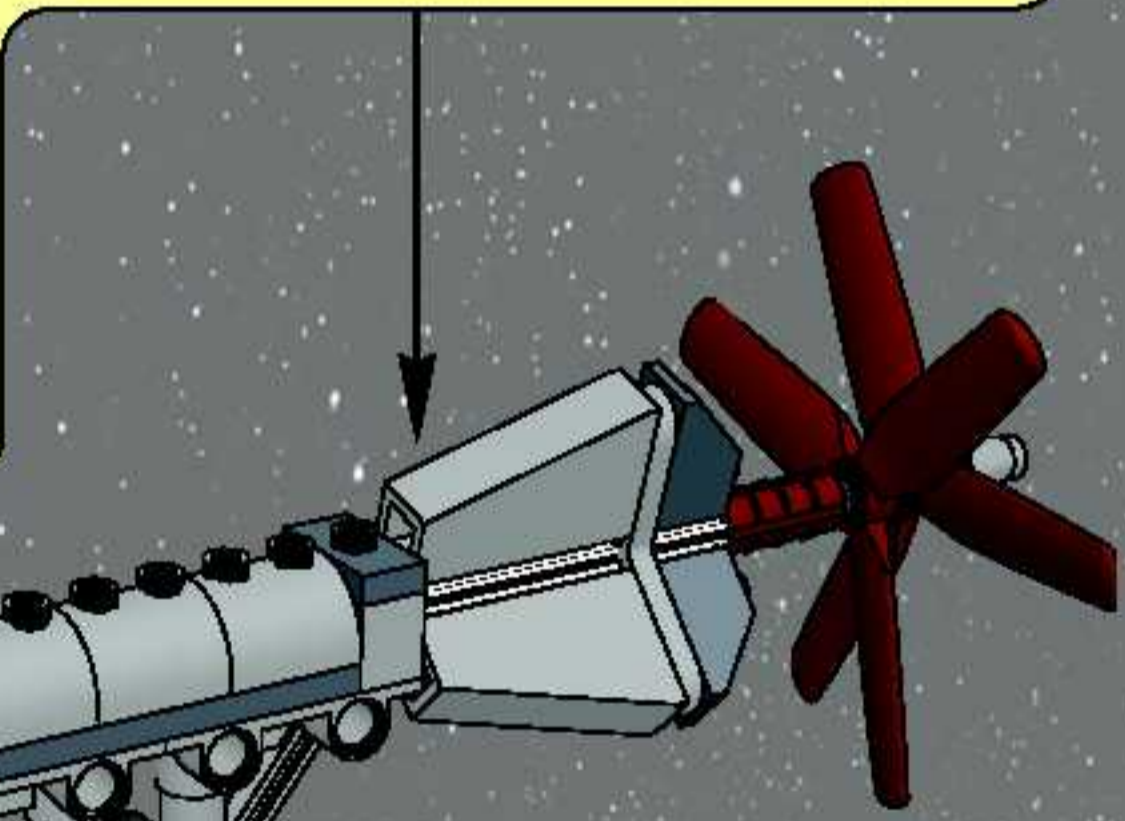
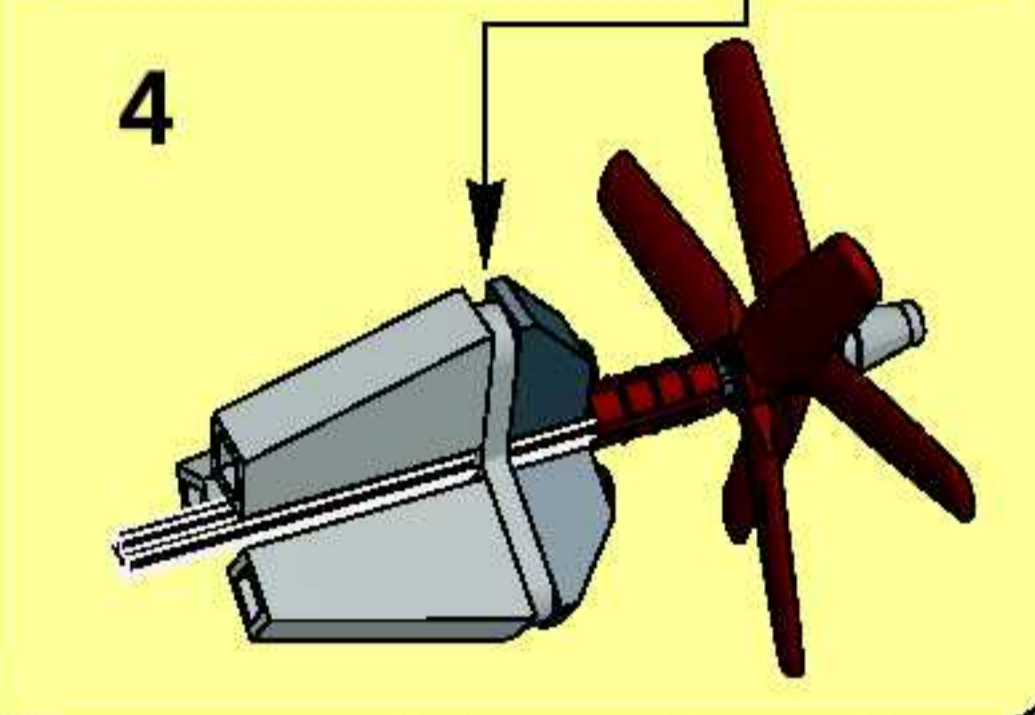
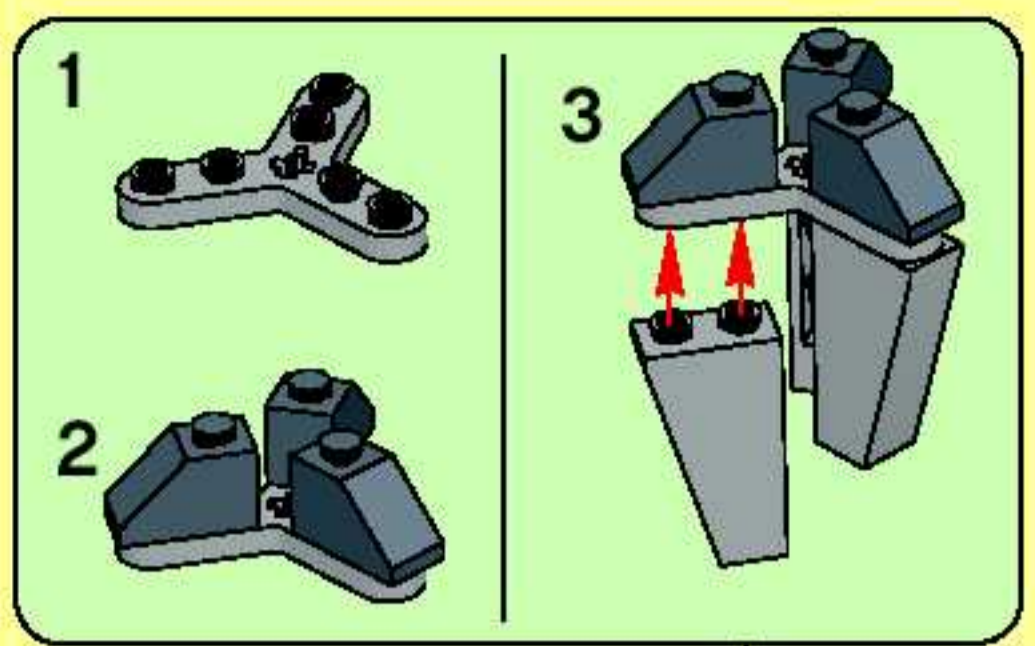
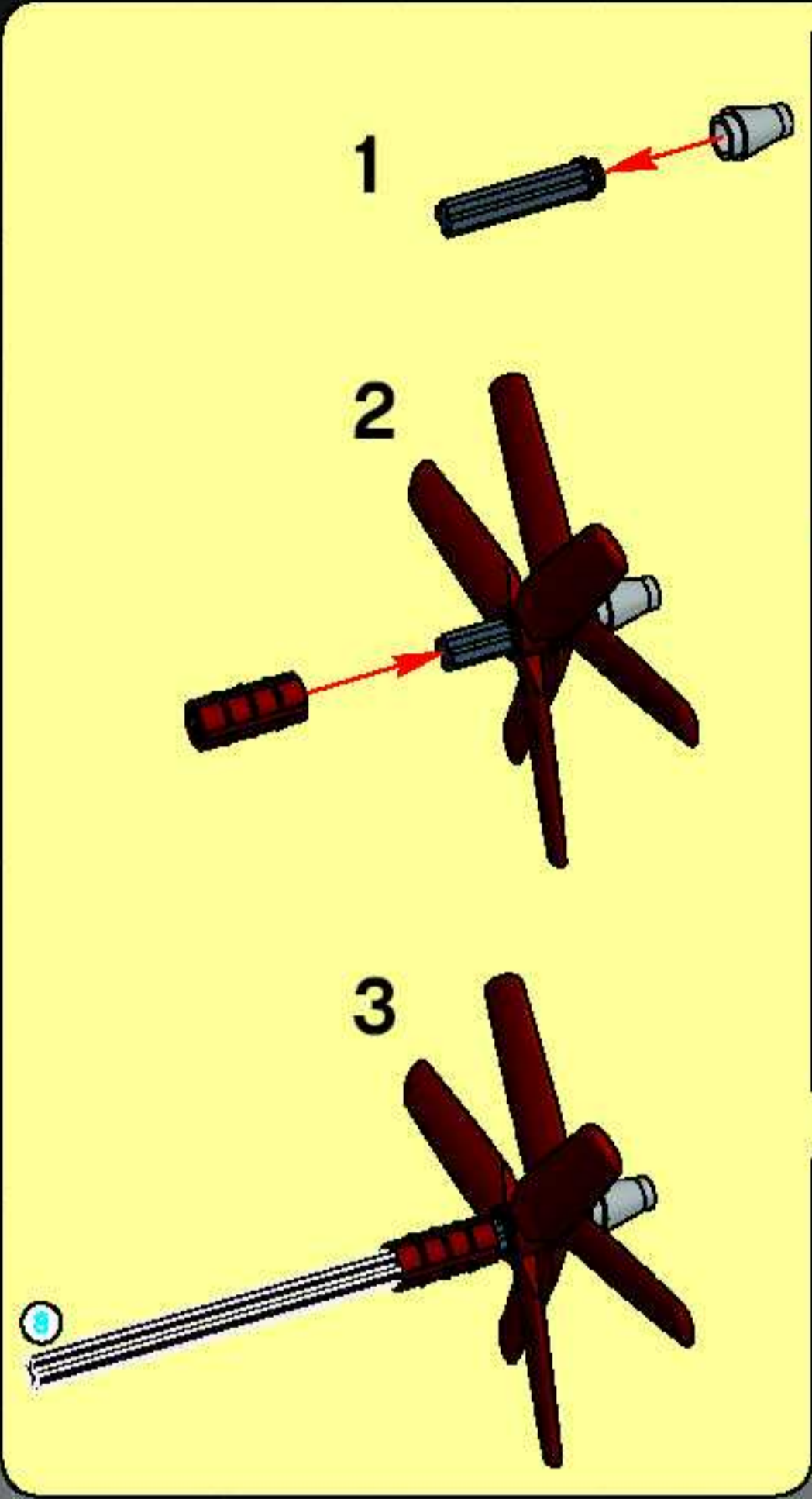

12

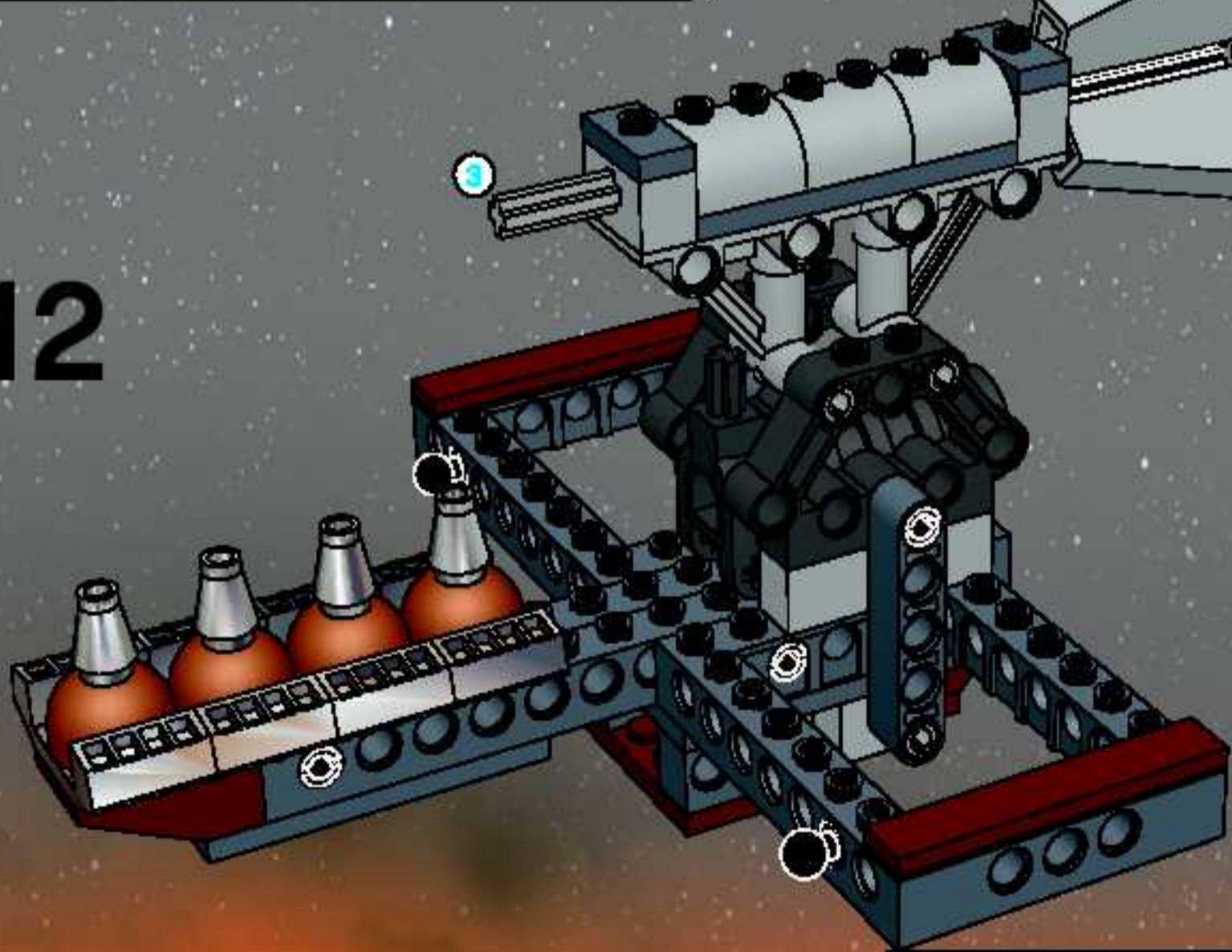

13

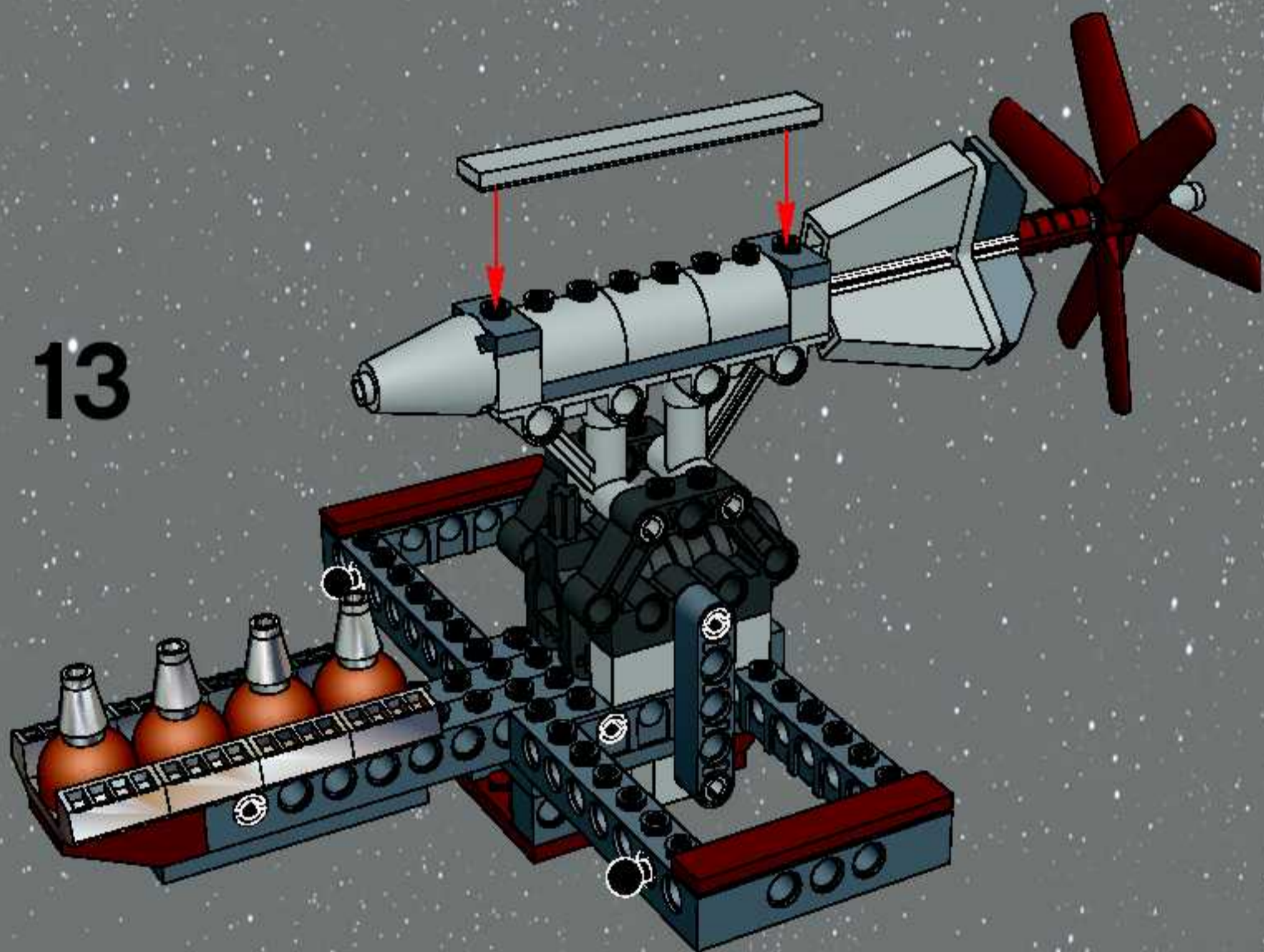

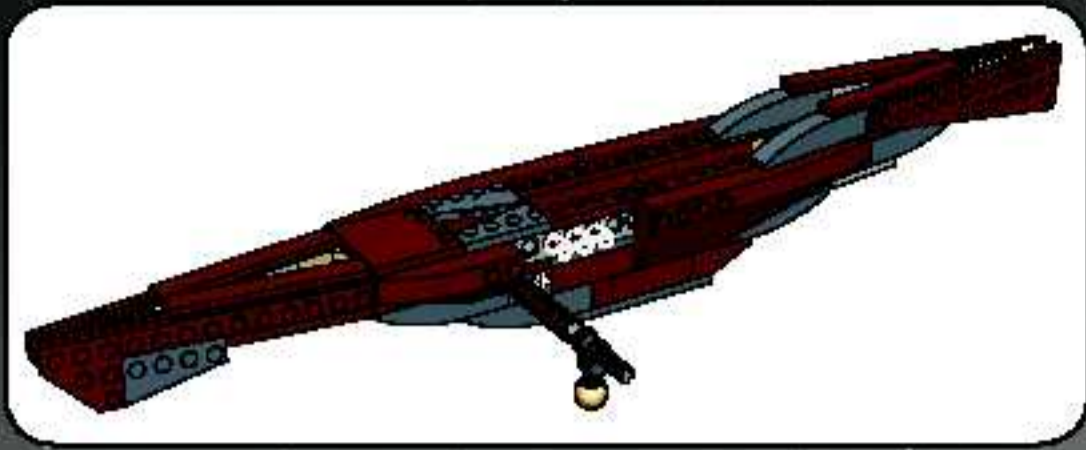

1



2

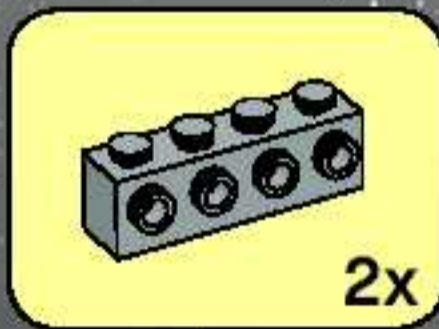
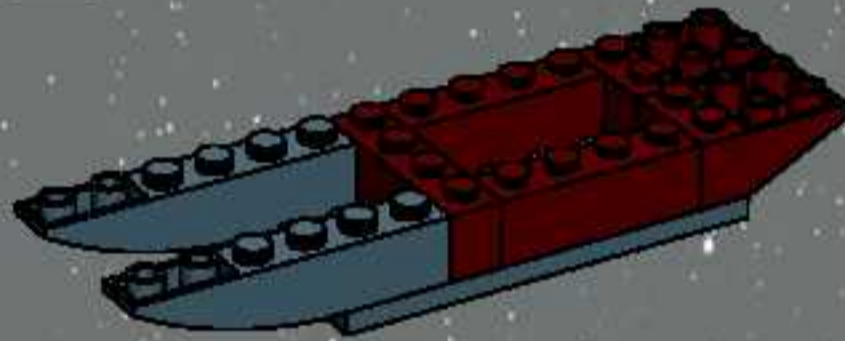

3





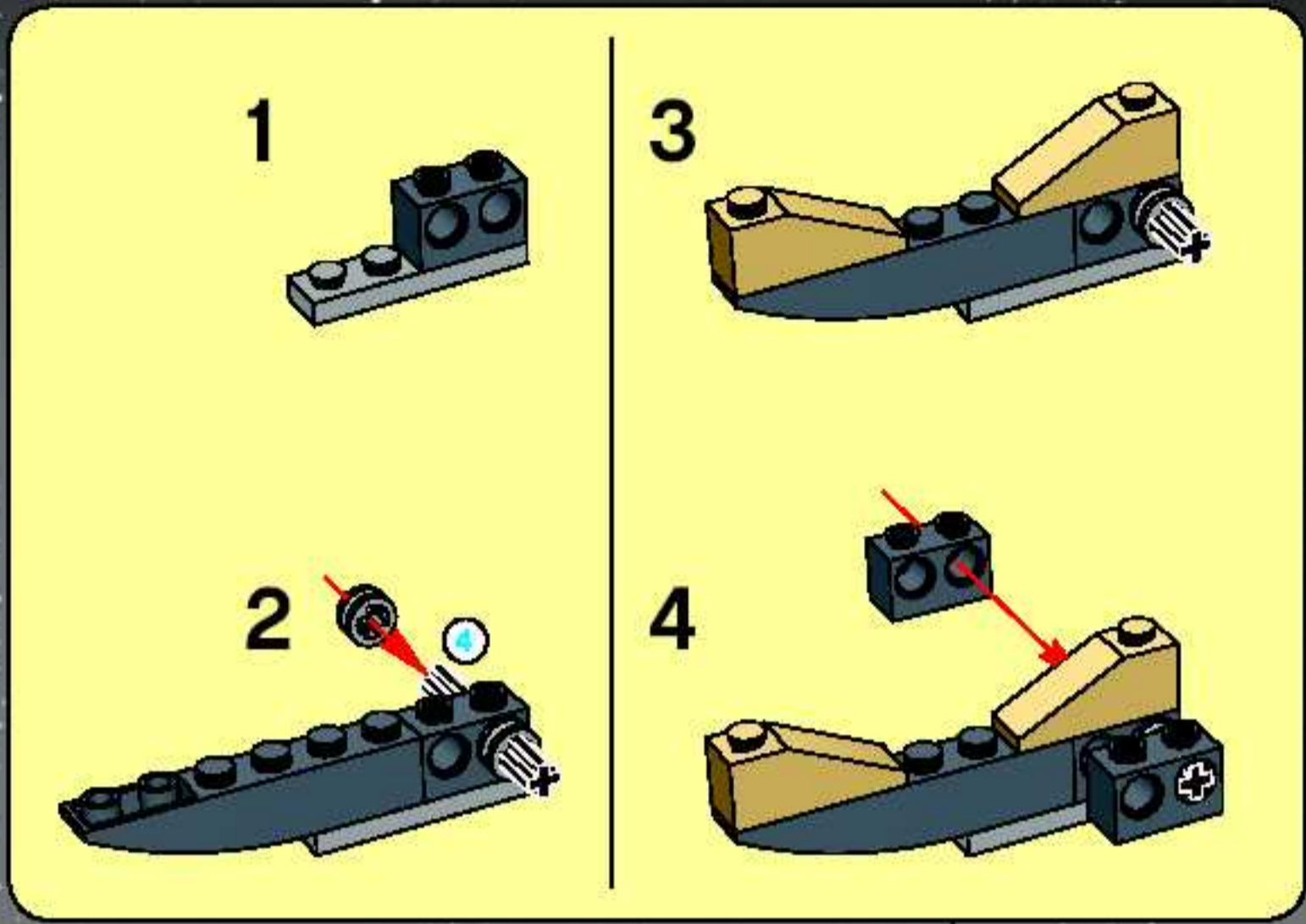

4

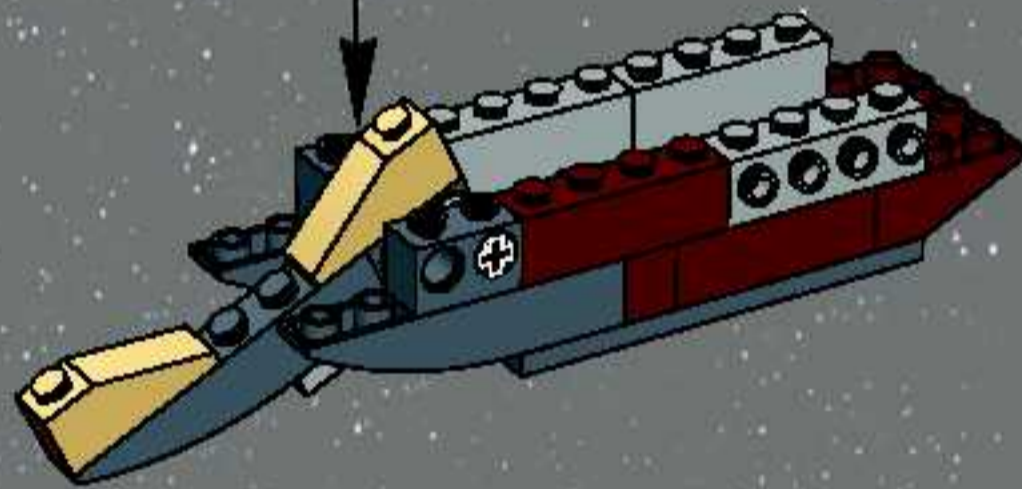

5

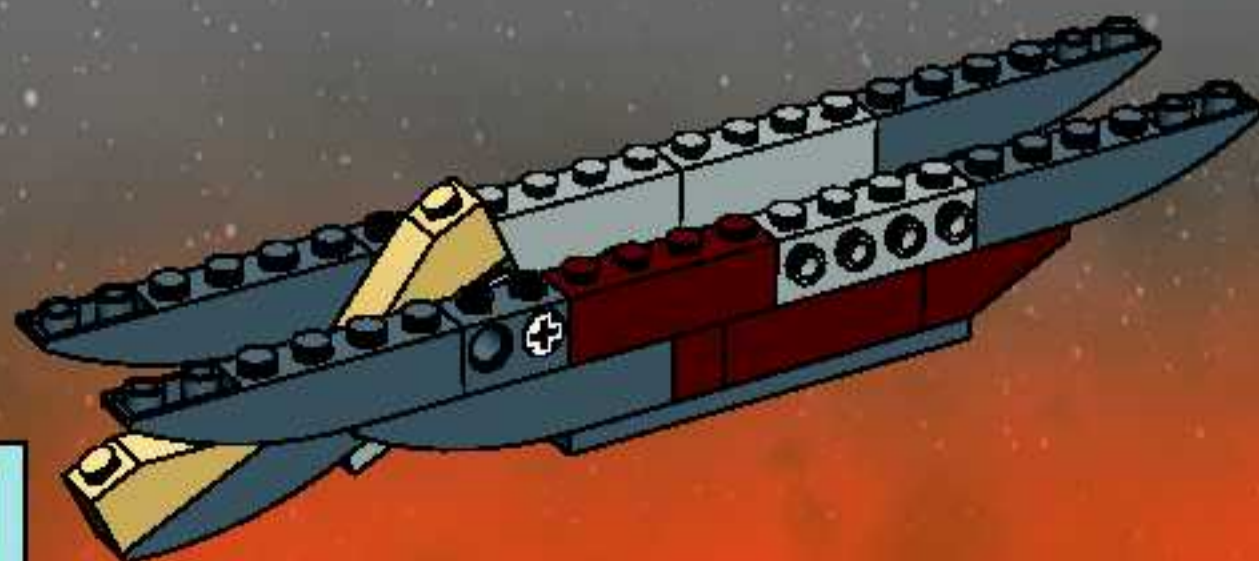

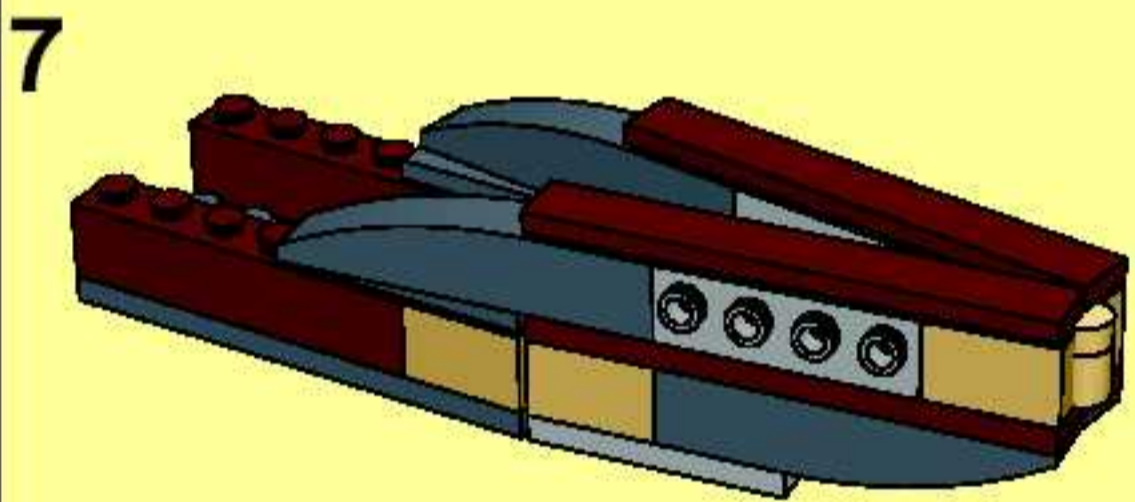
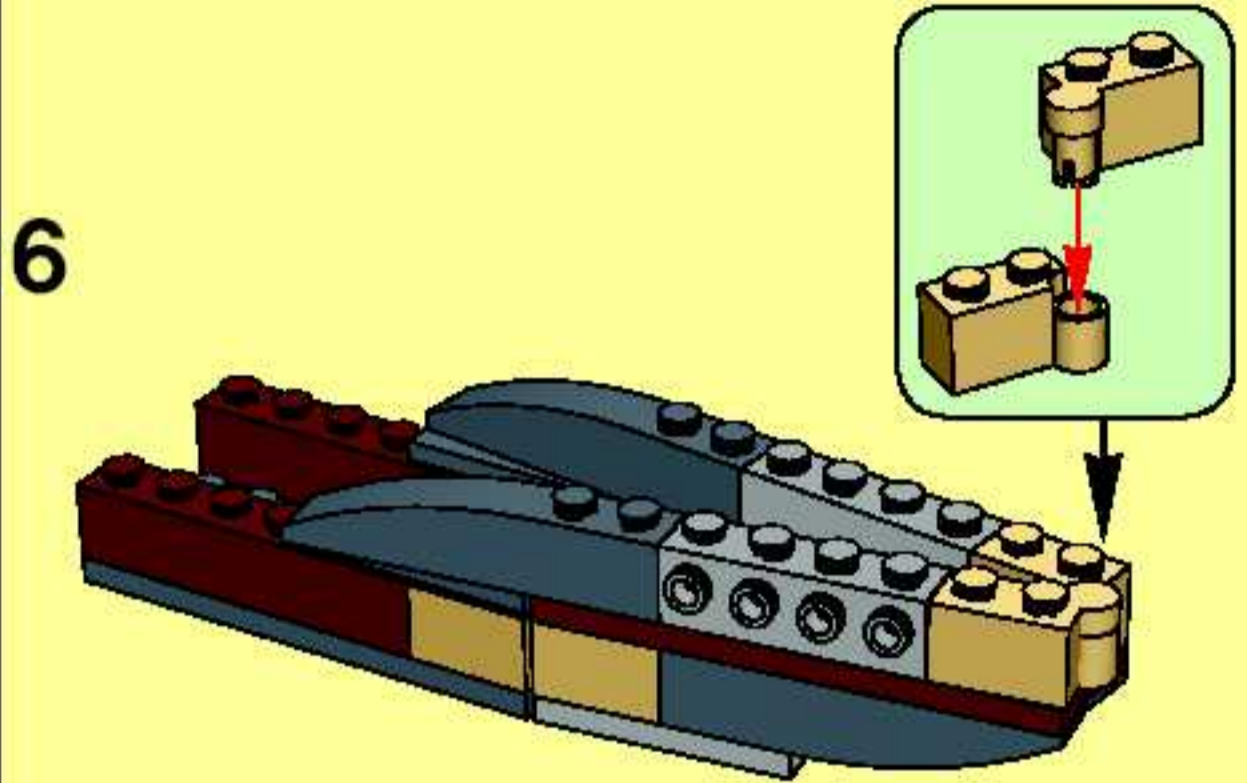
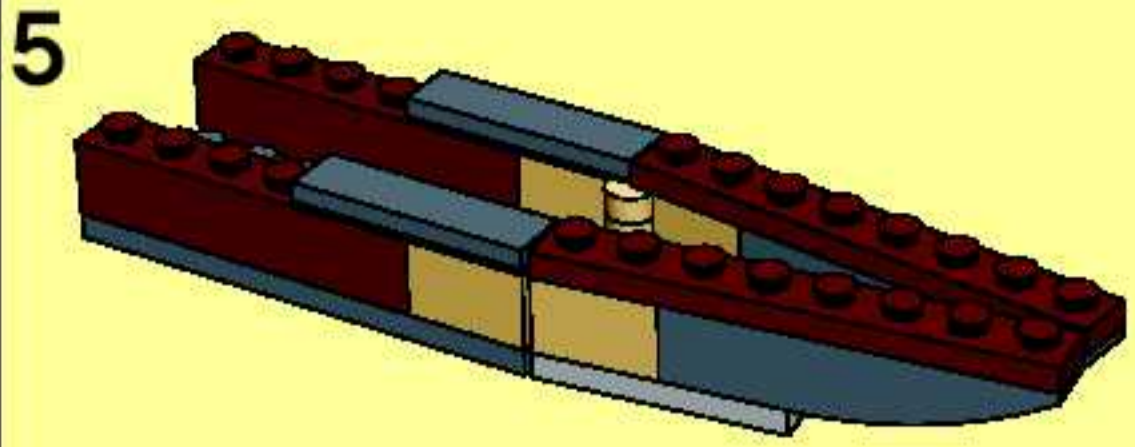
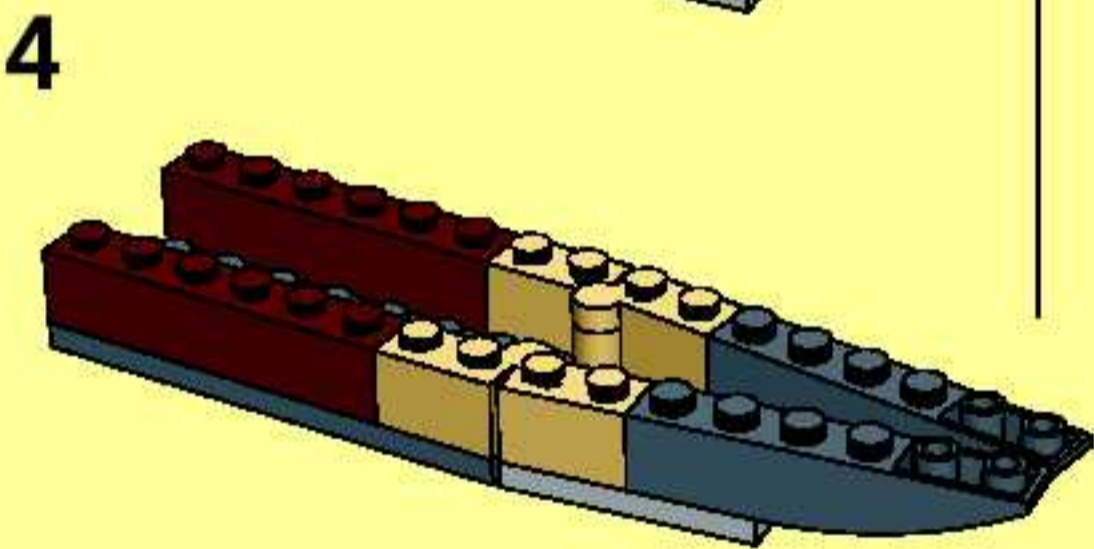
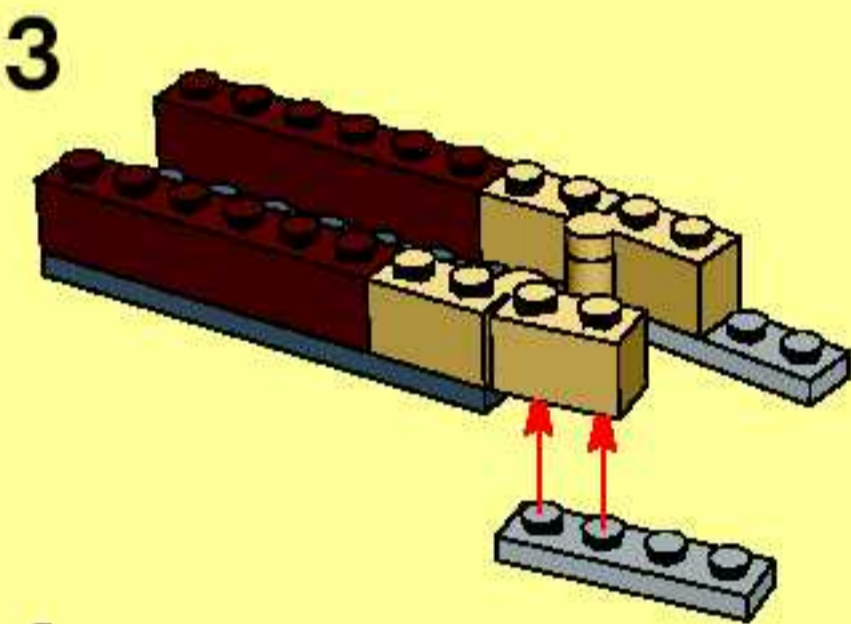
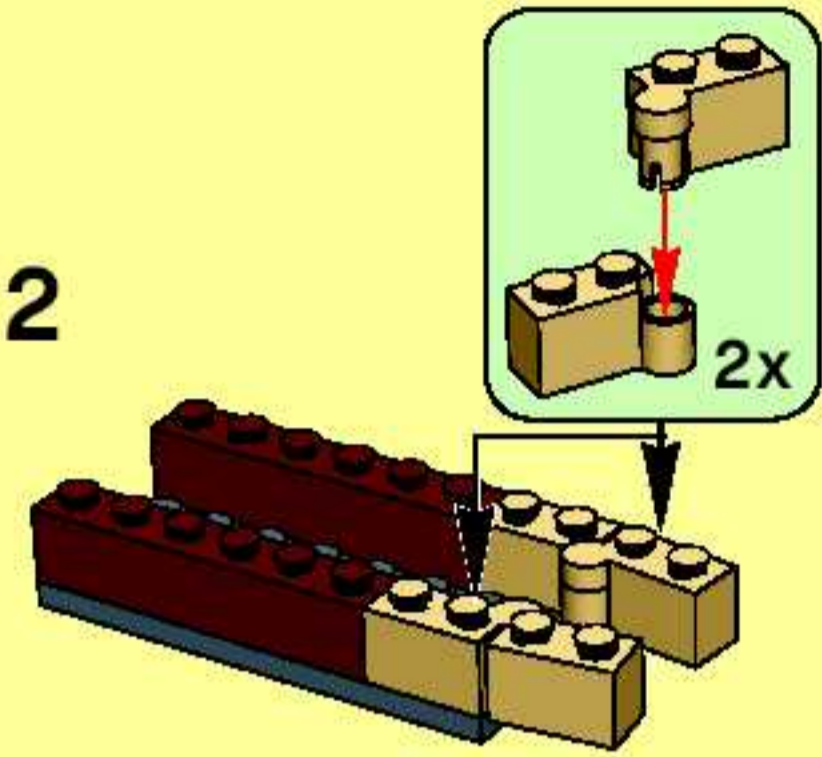
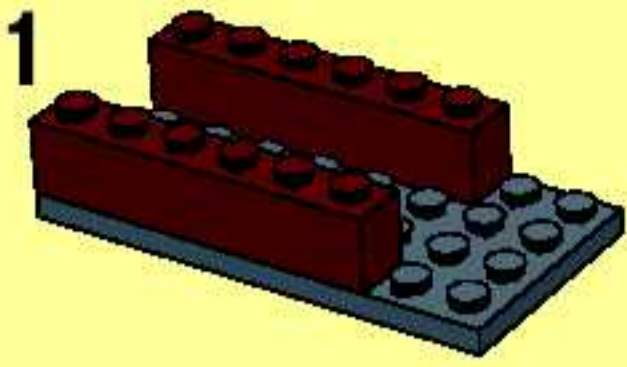

6

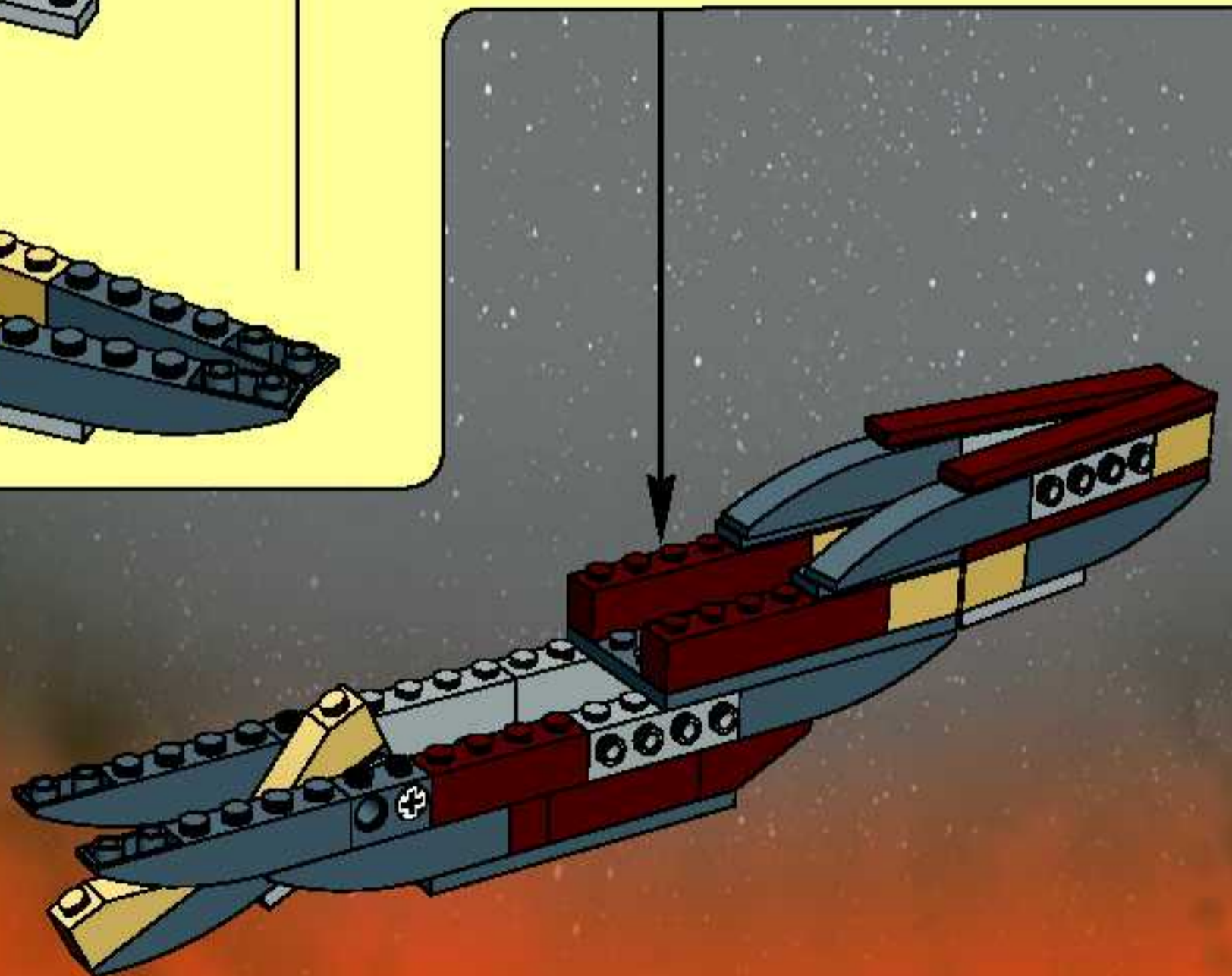

1

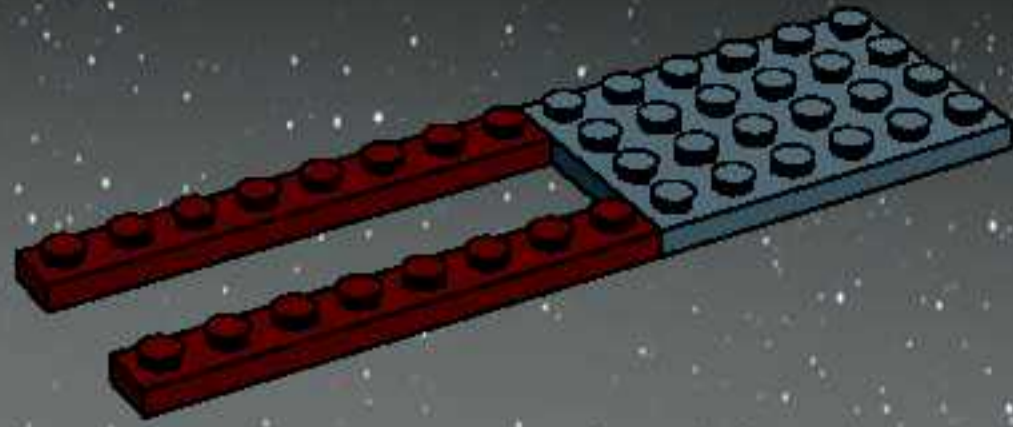

2

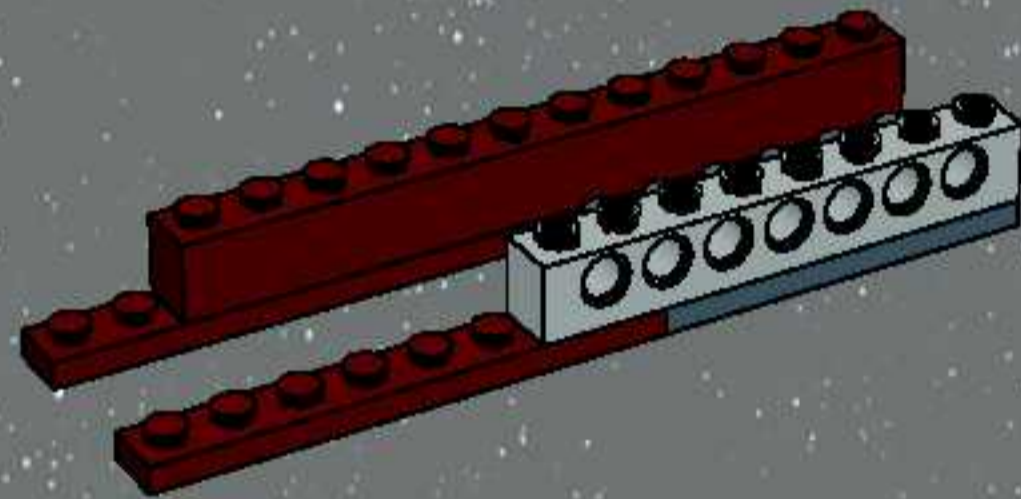

3

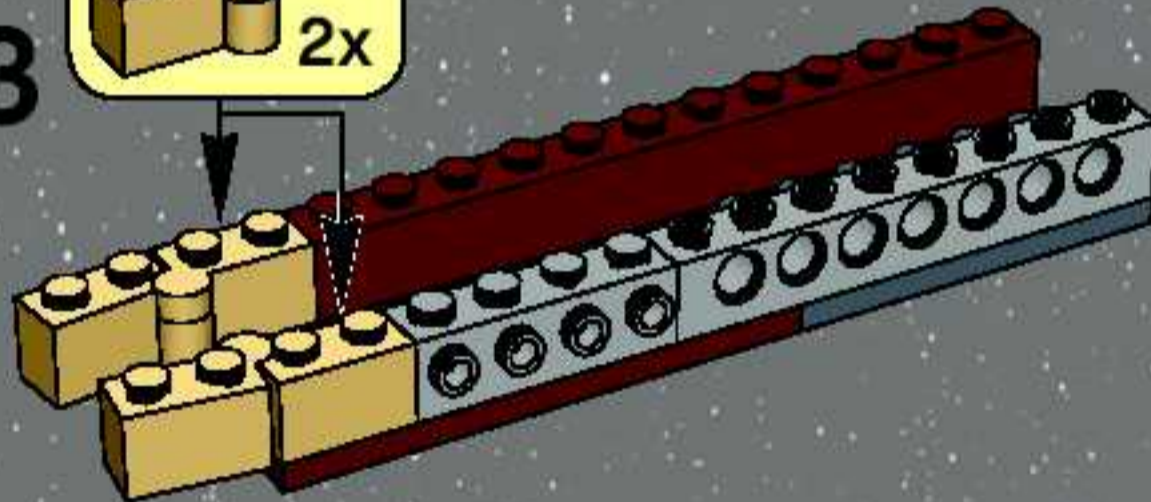
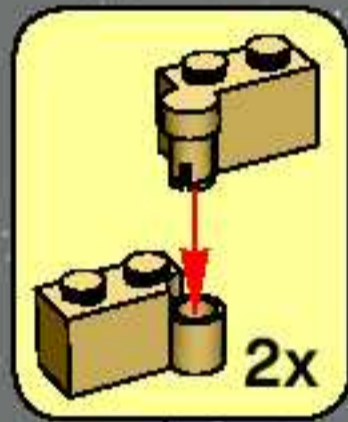

4

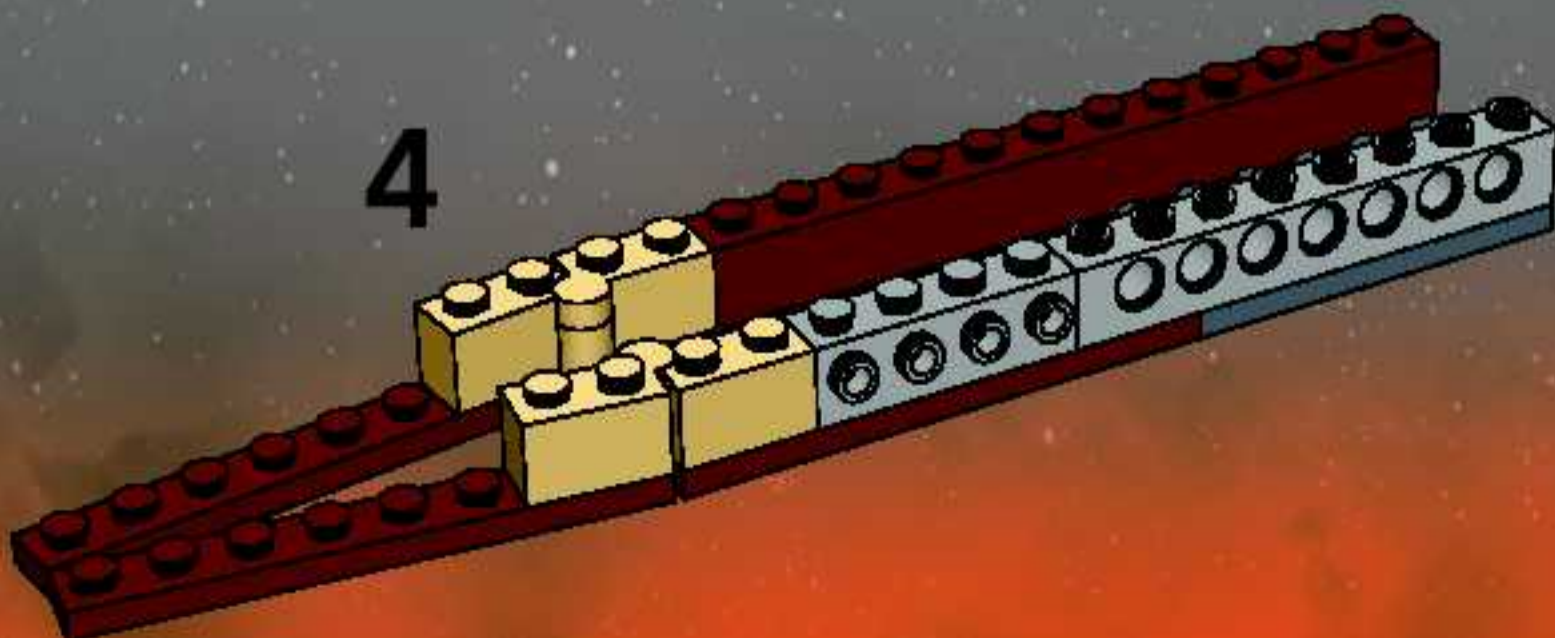

5

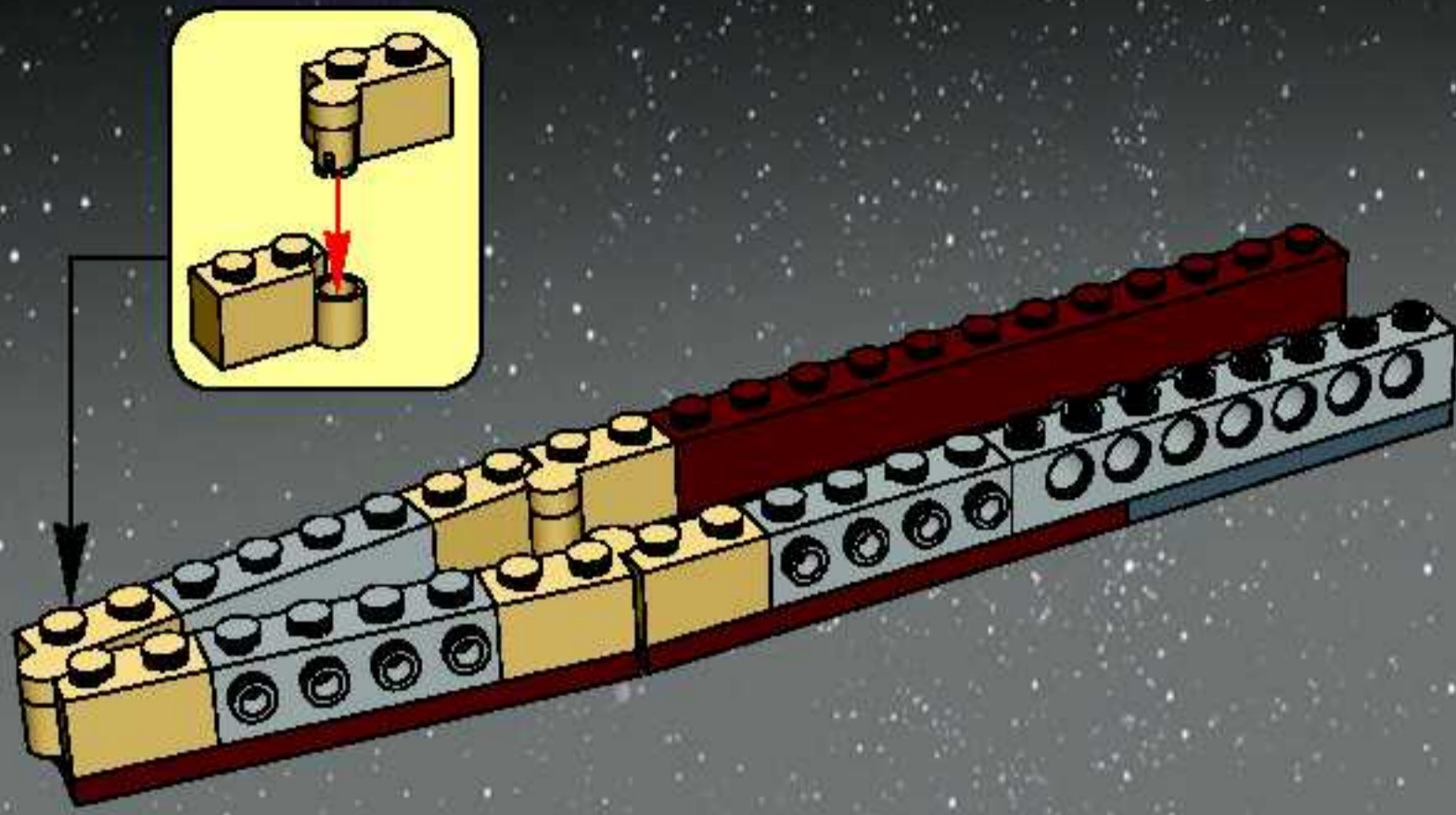

6

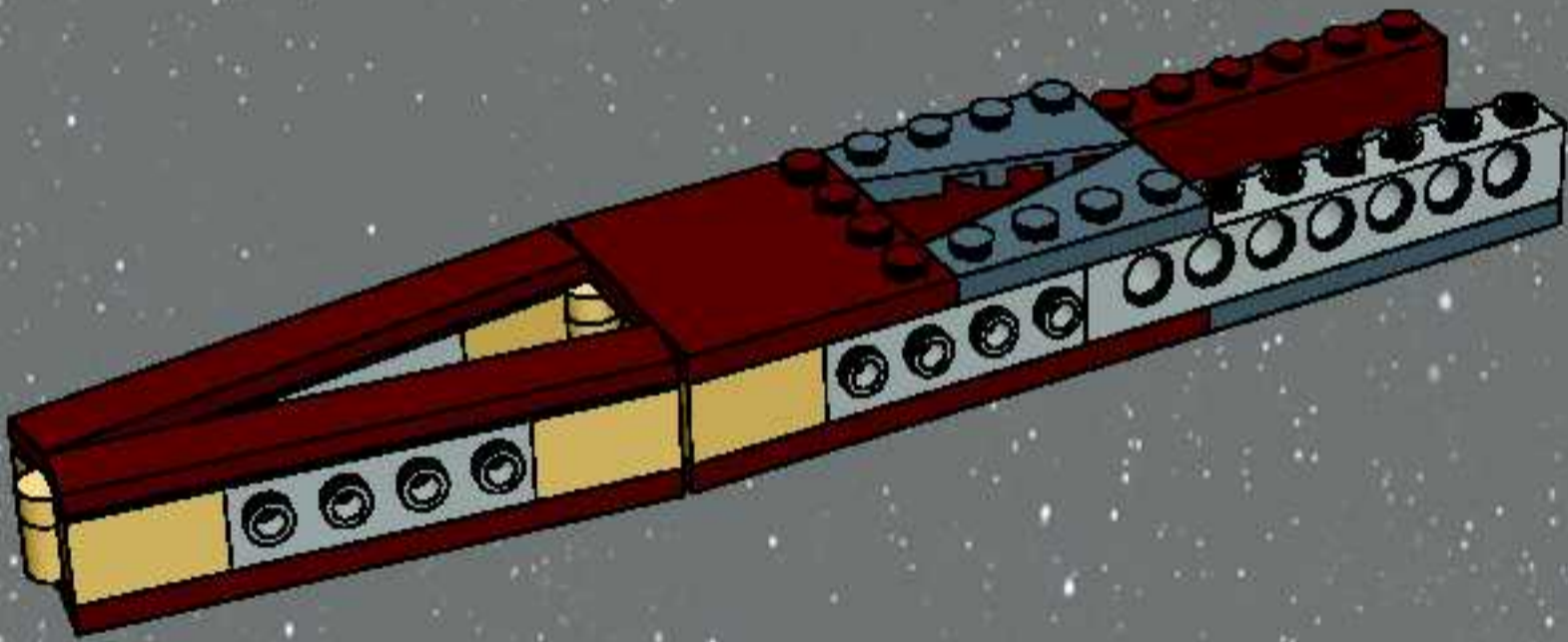

7

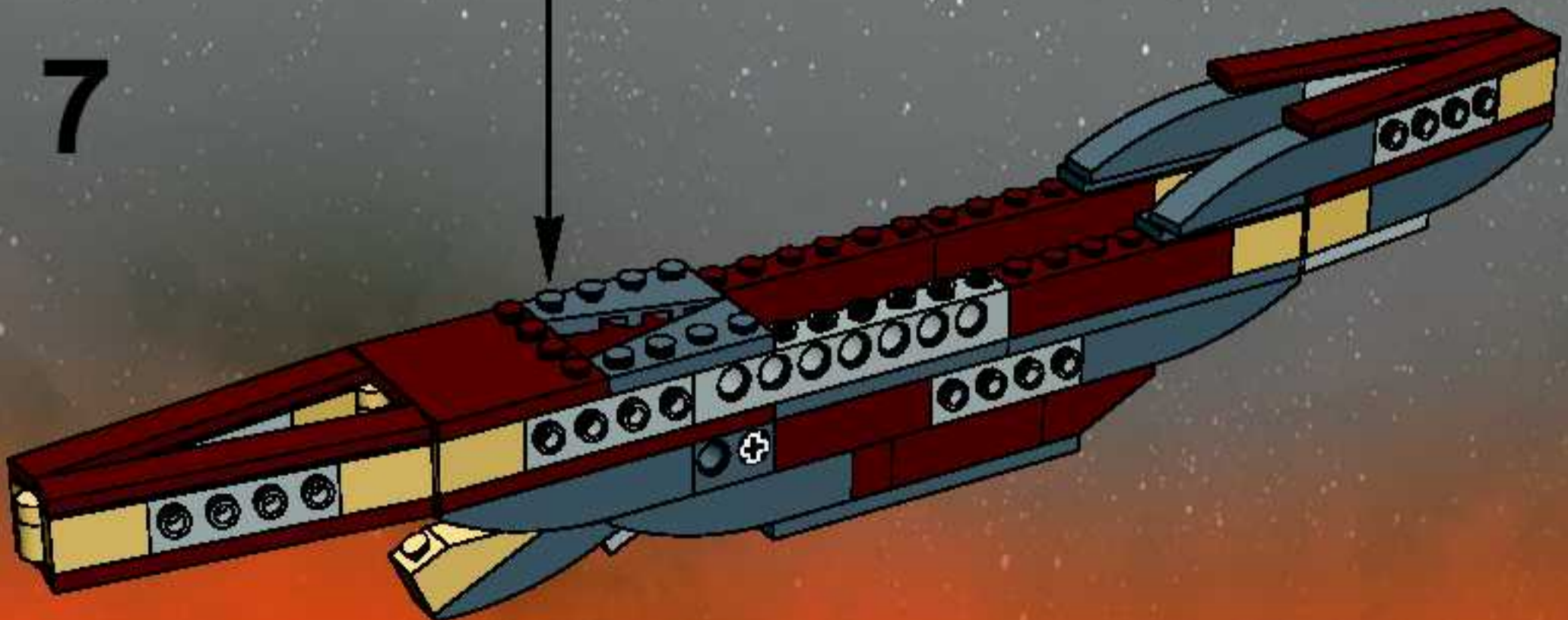

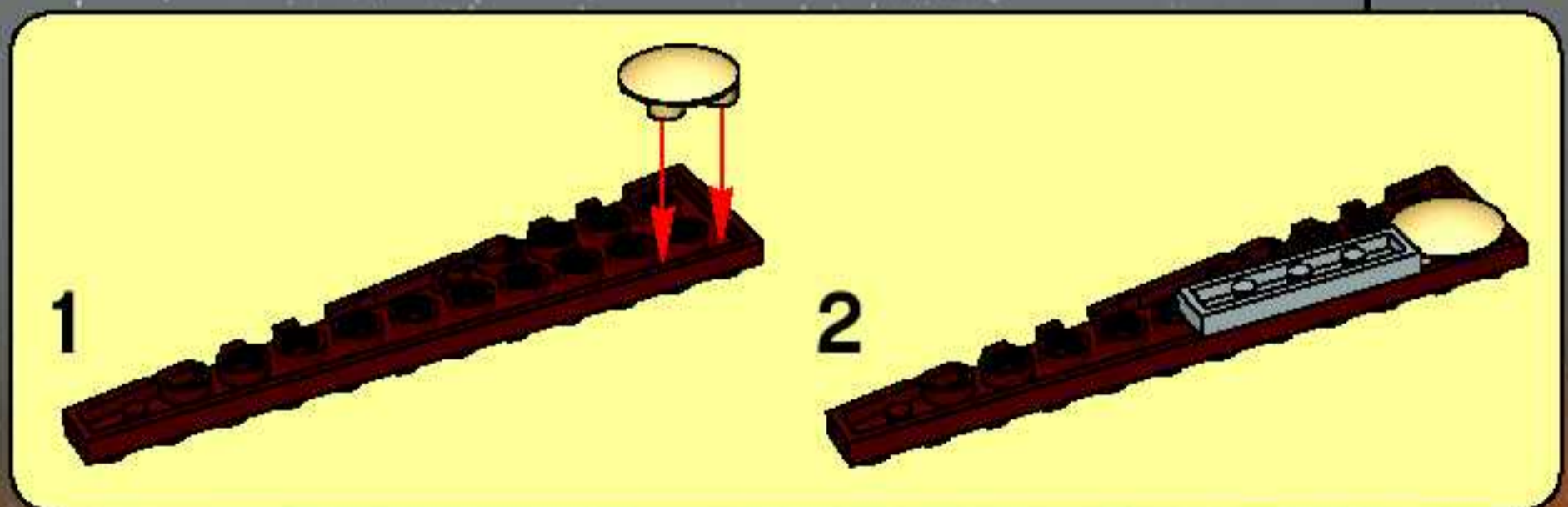
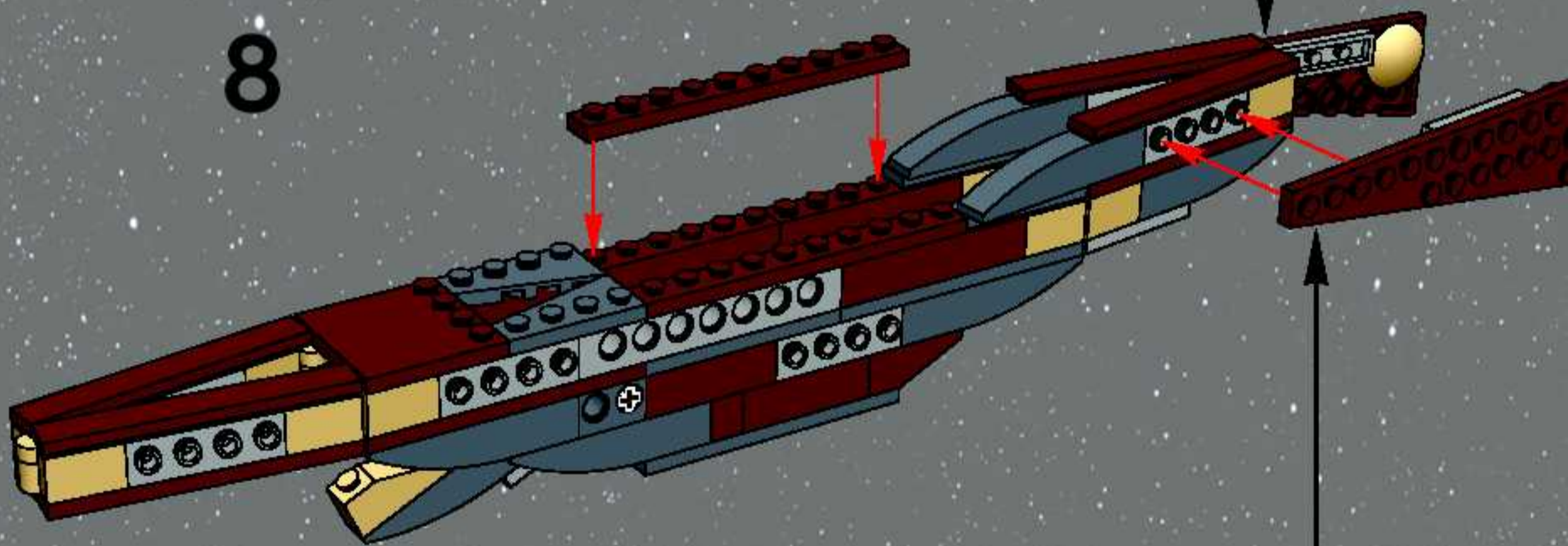
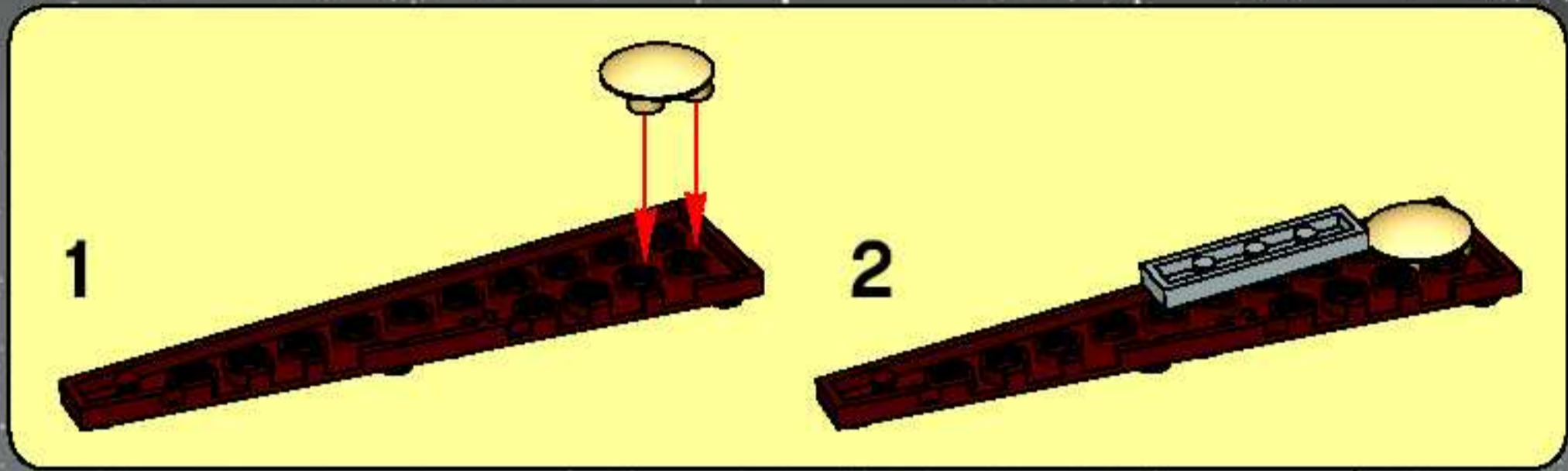

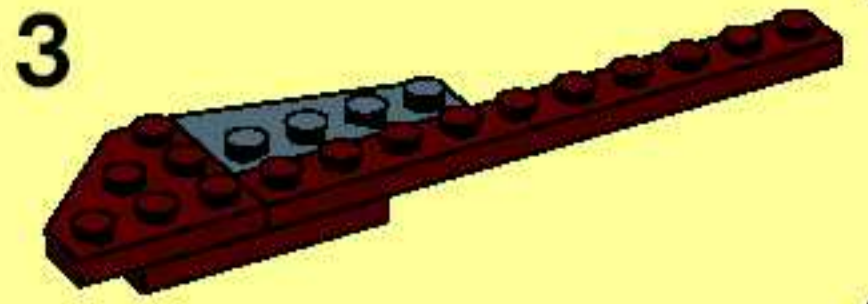
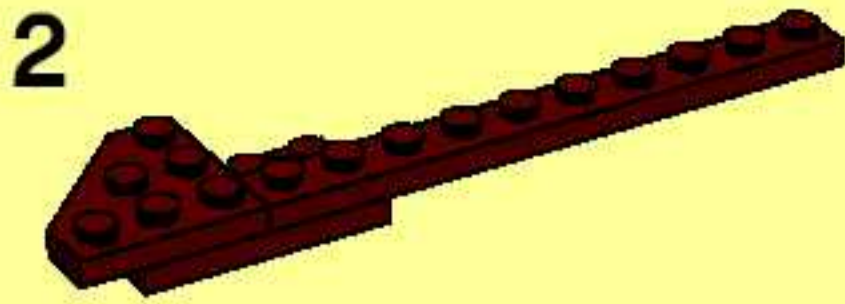

9

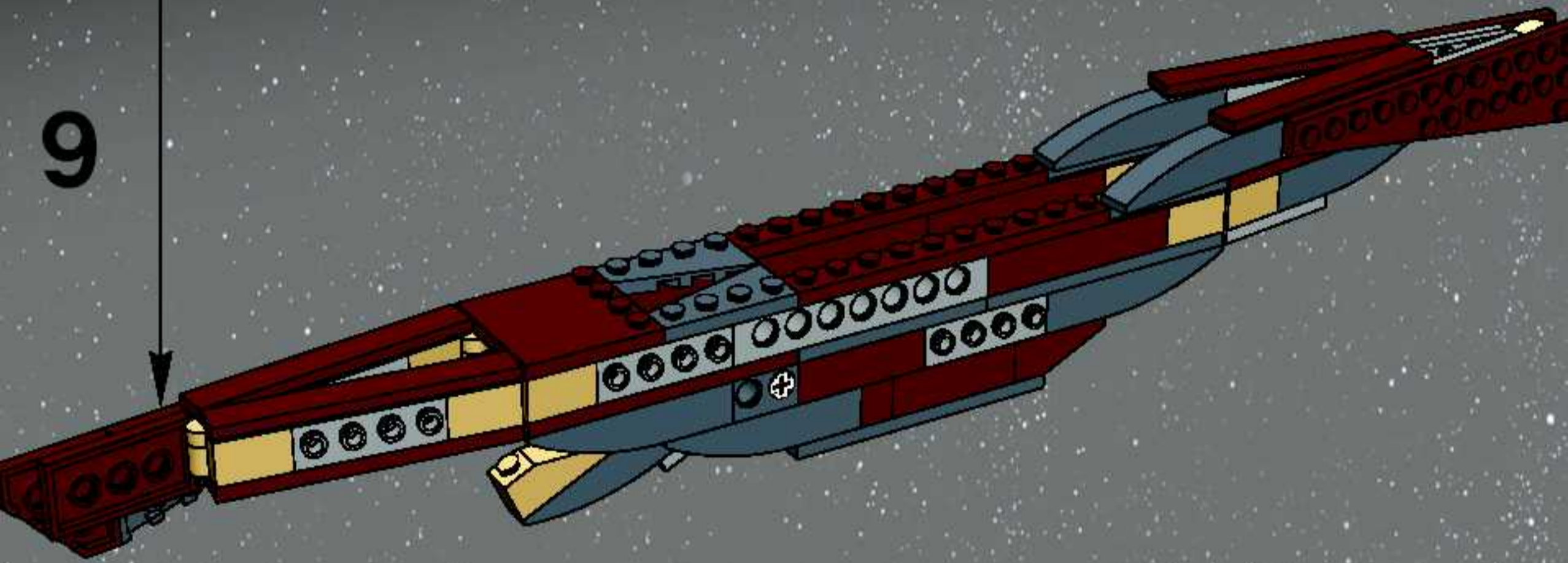

10

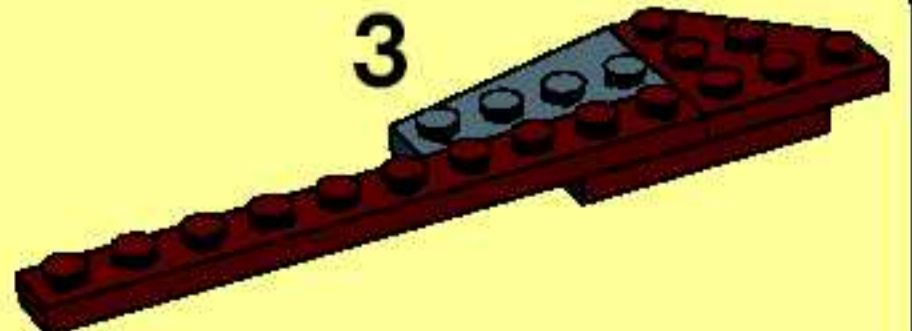
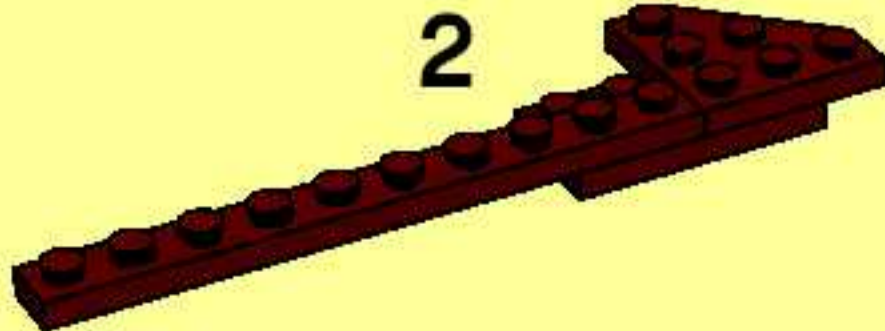
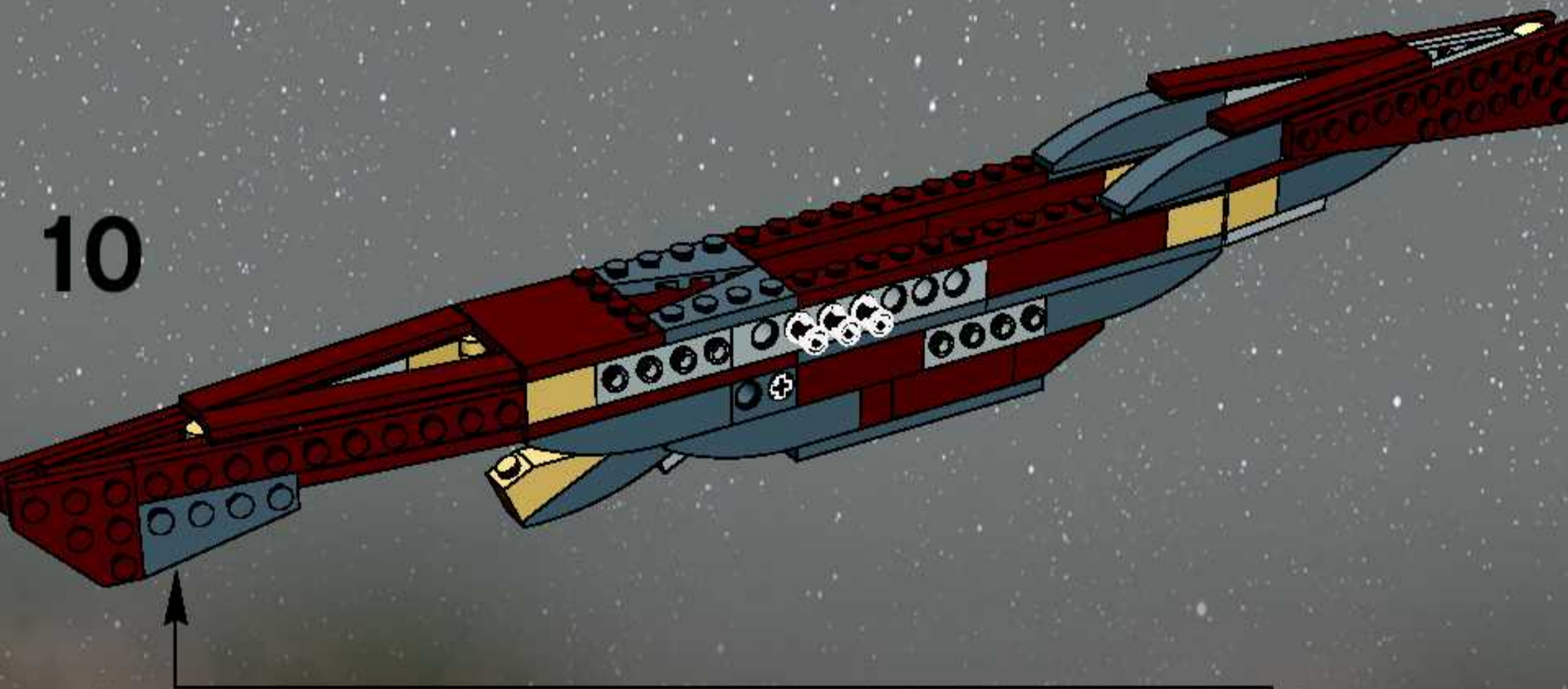

11

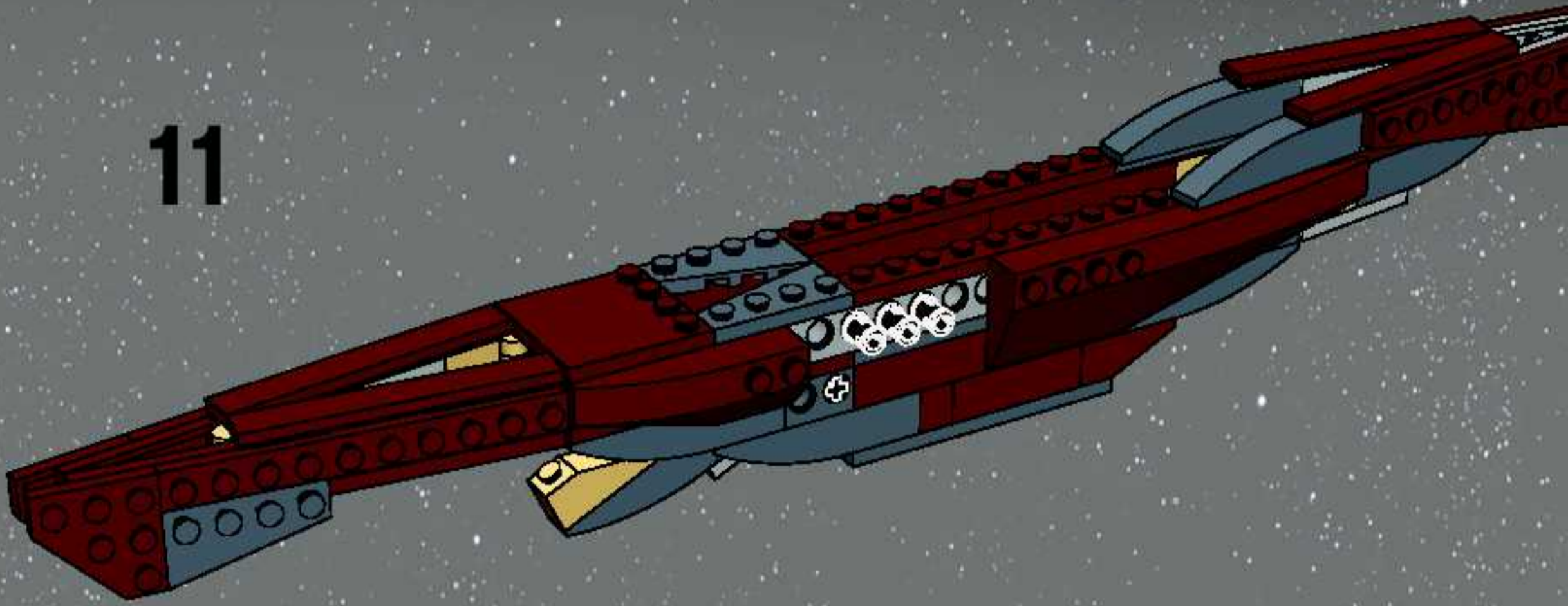

12

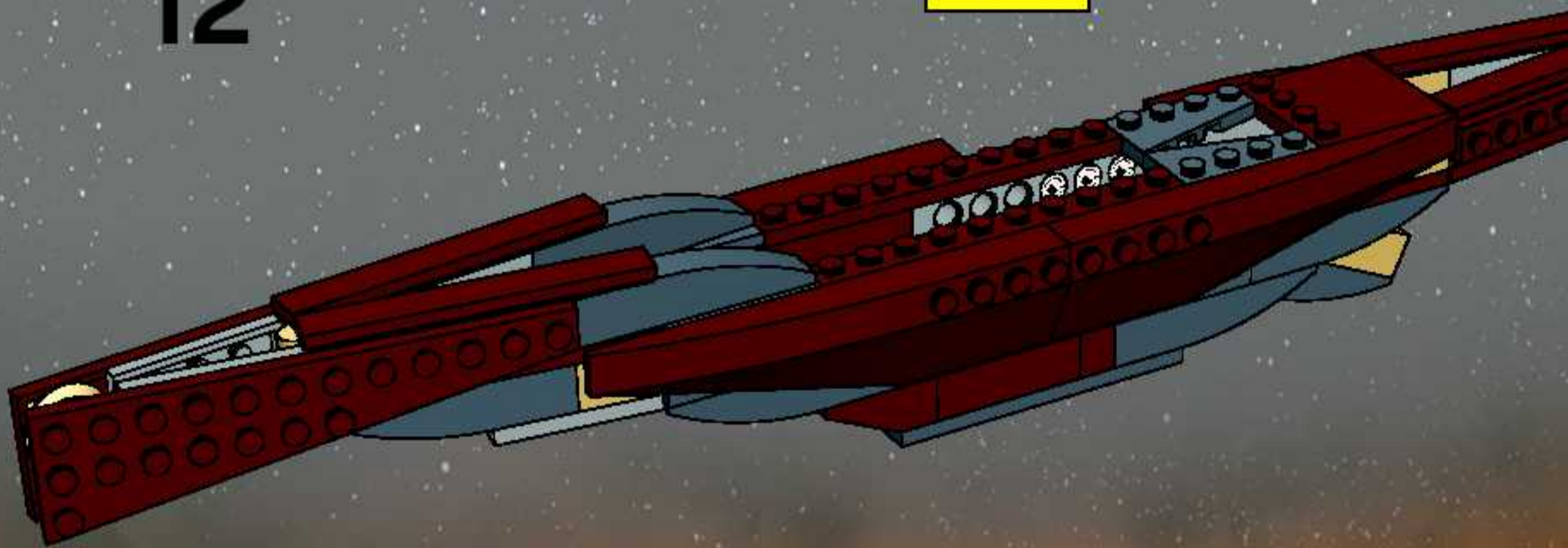

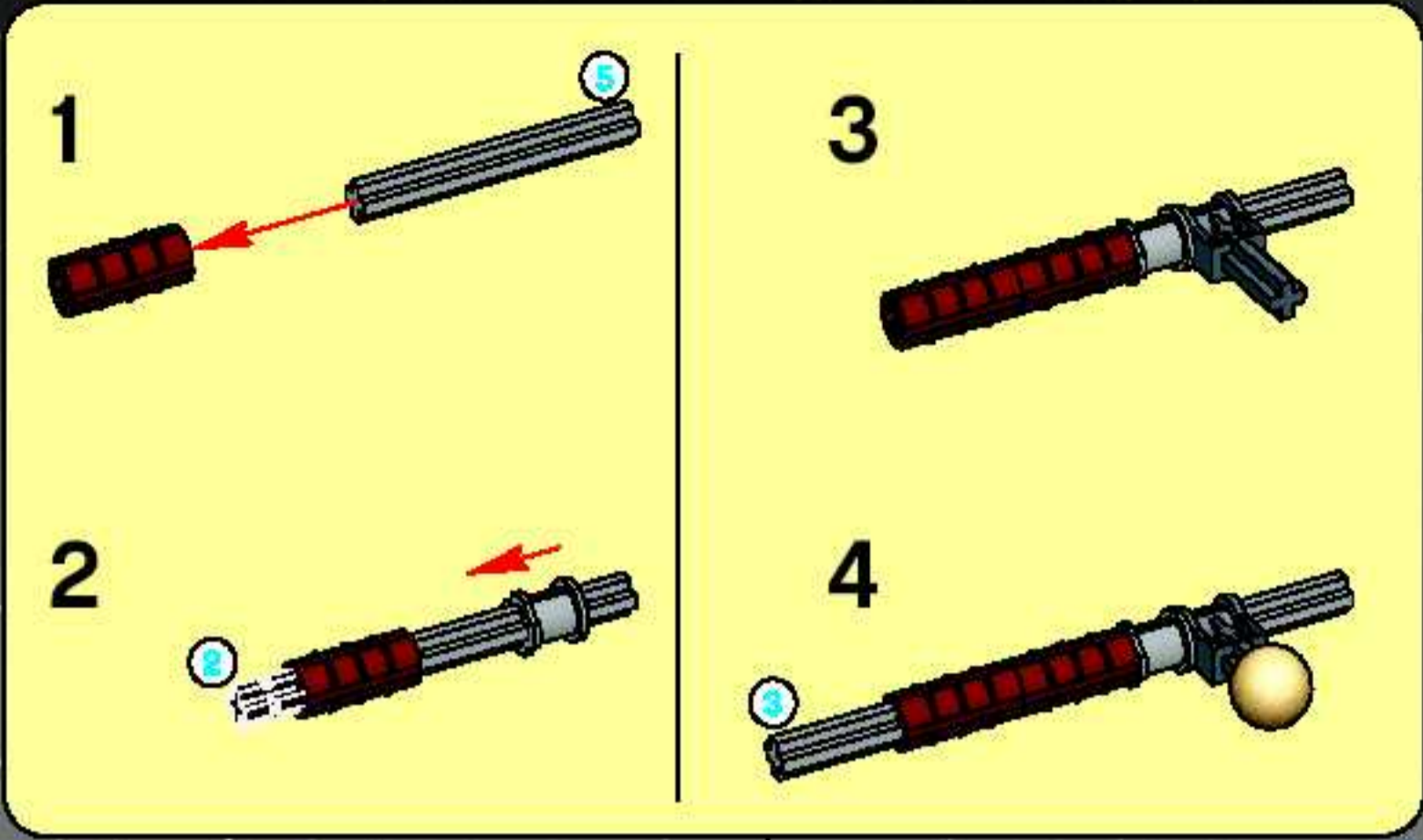

13

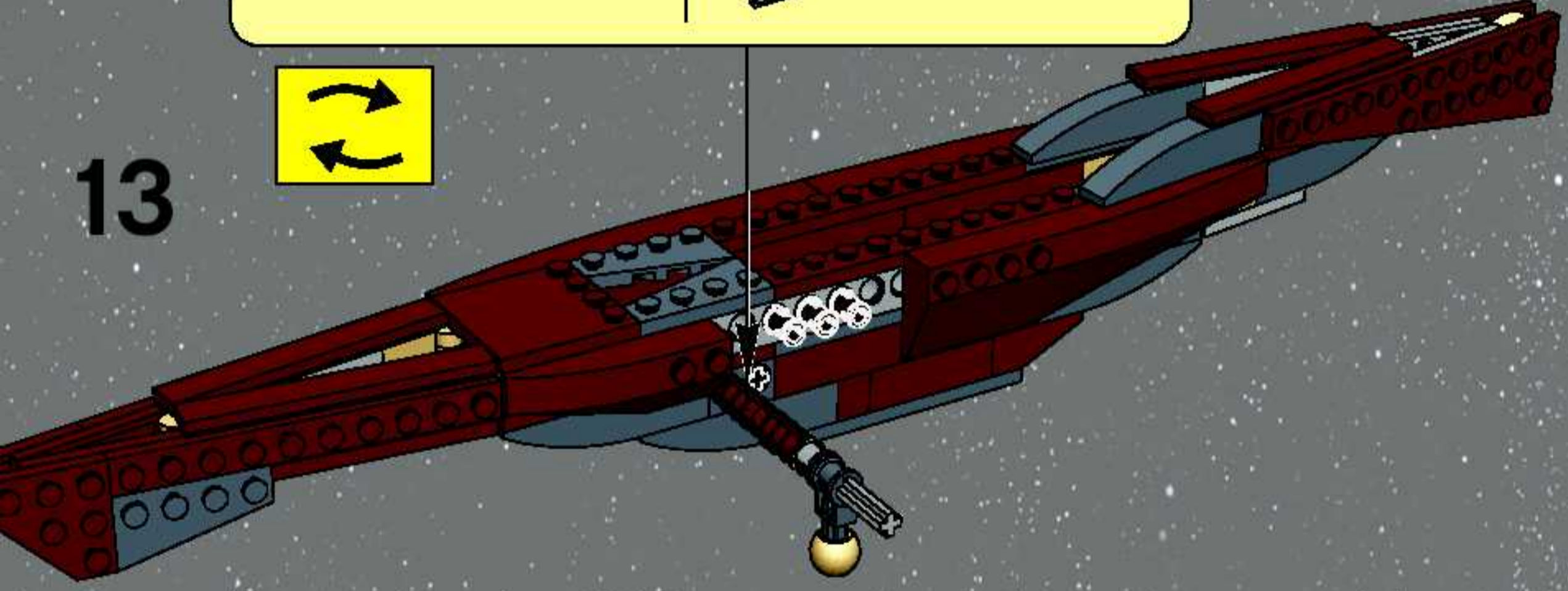

14

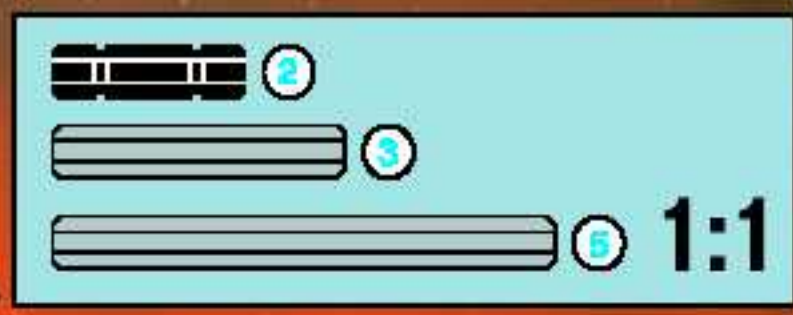
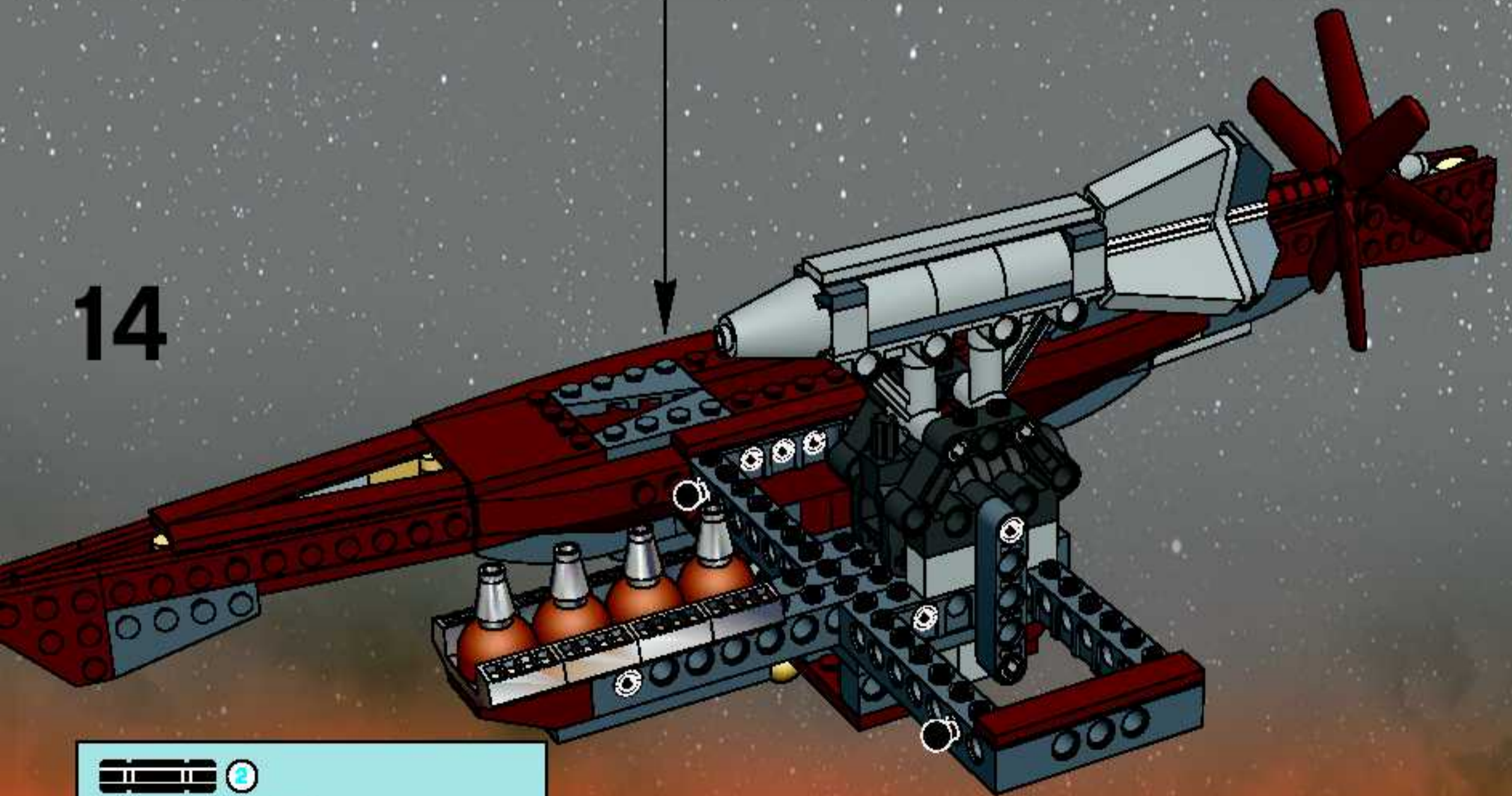



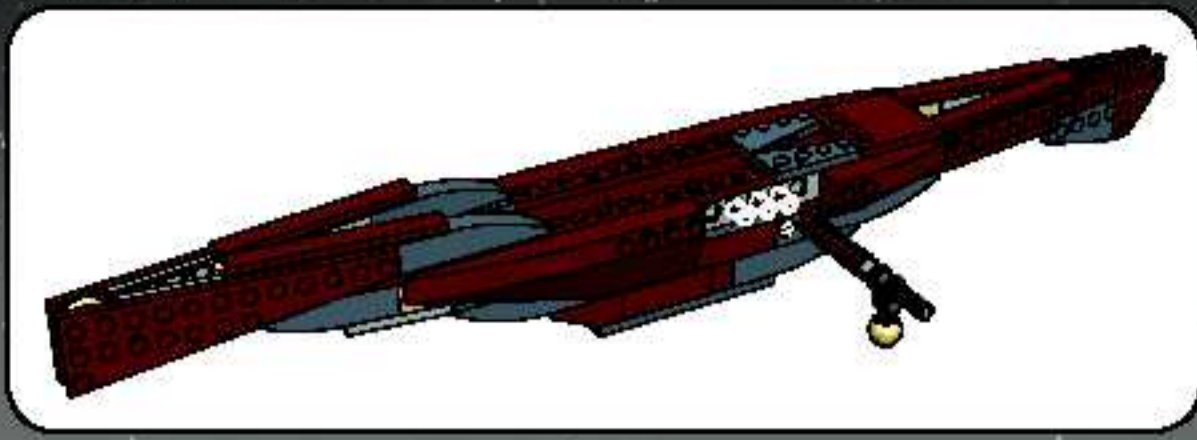

1



2

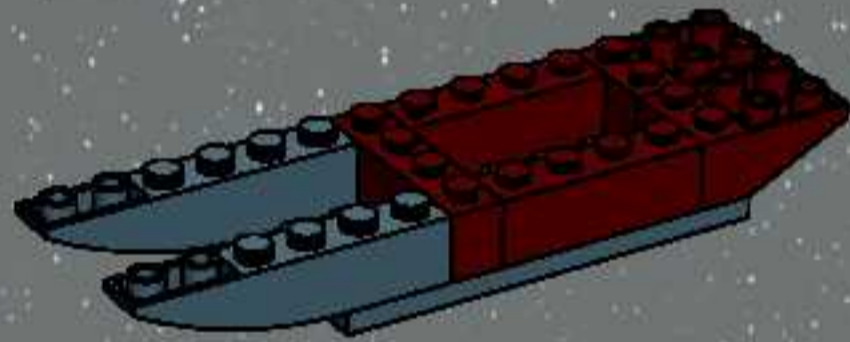

3

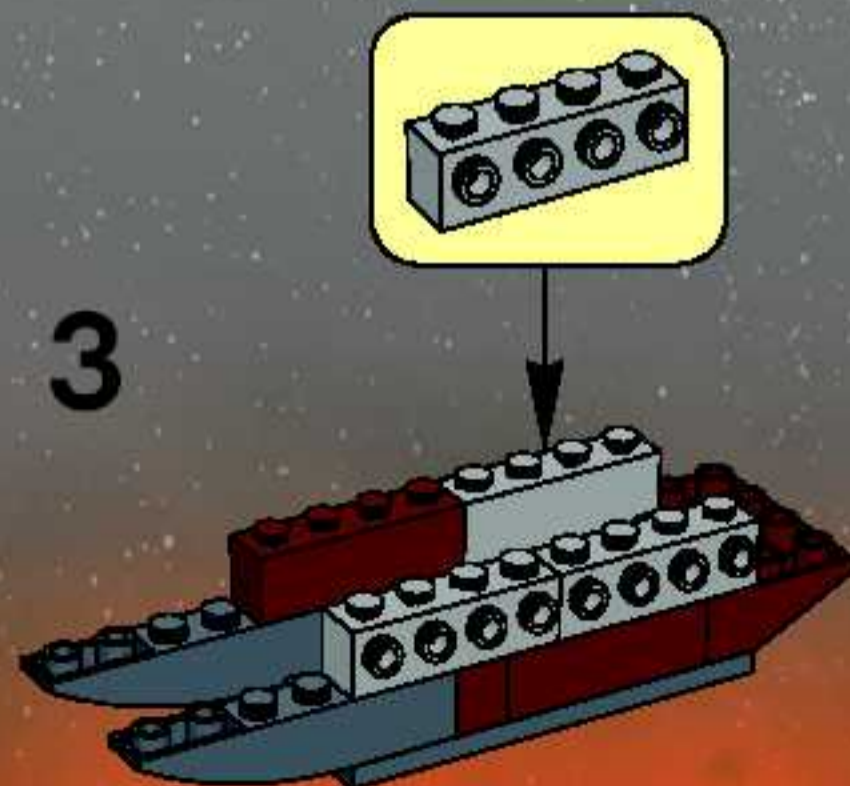

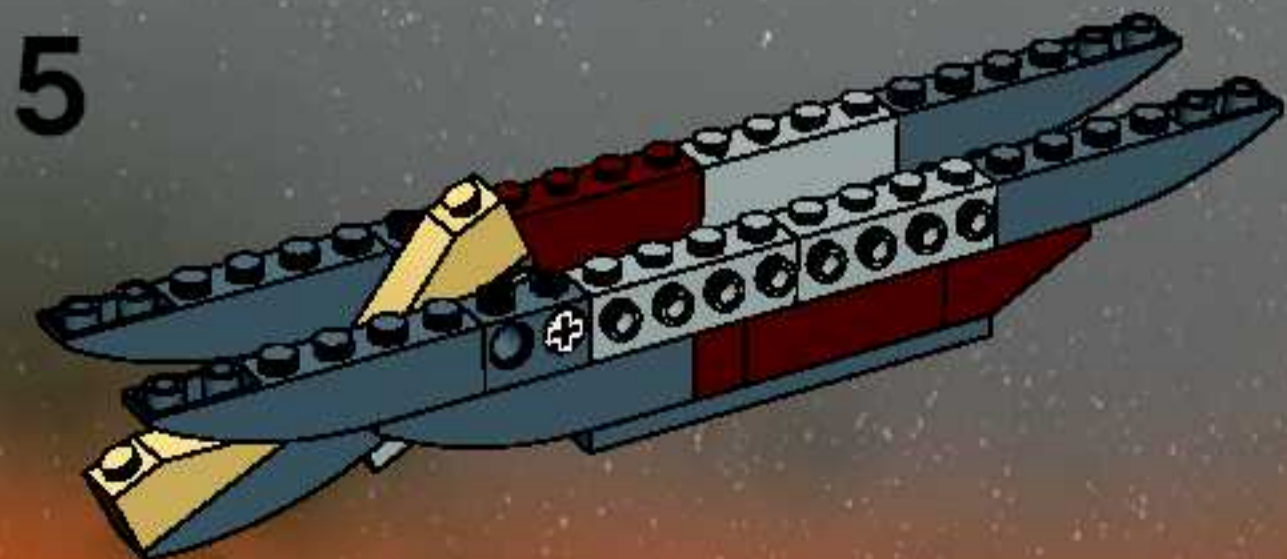
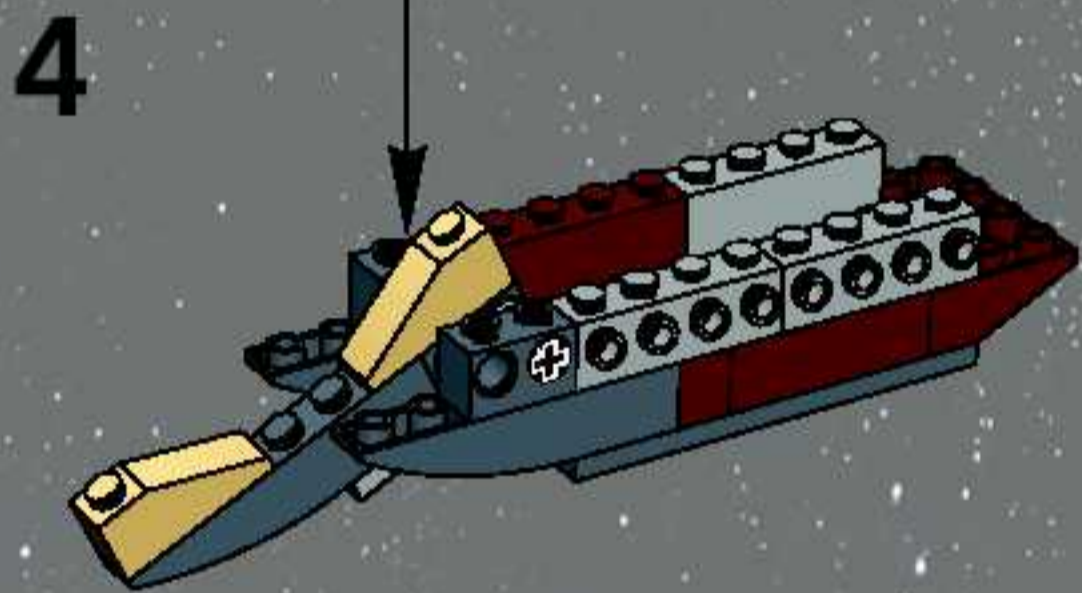
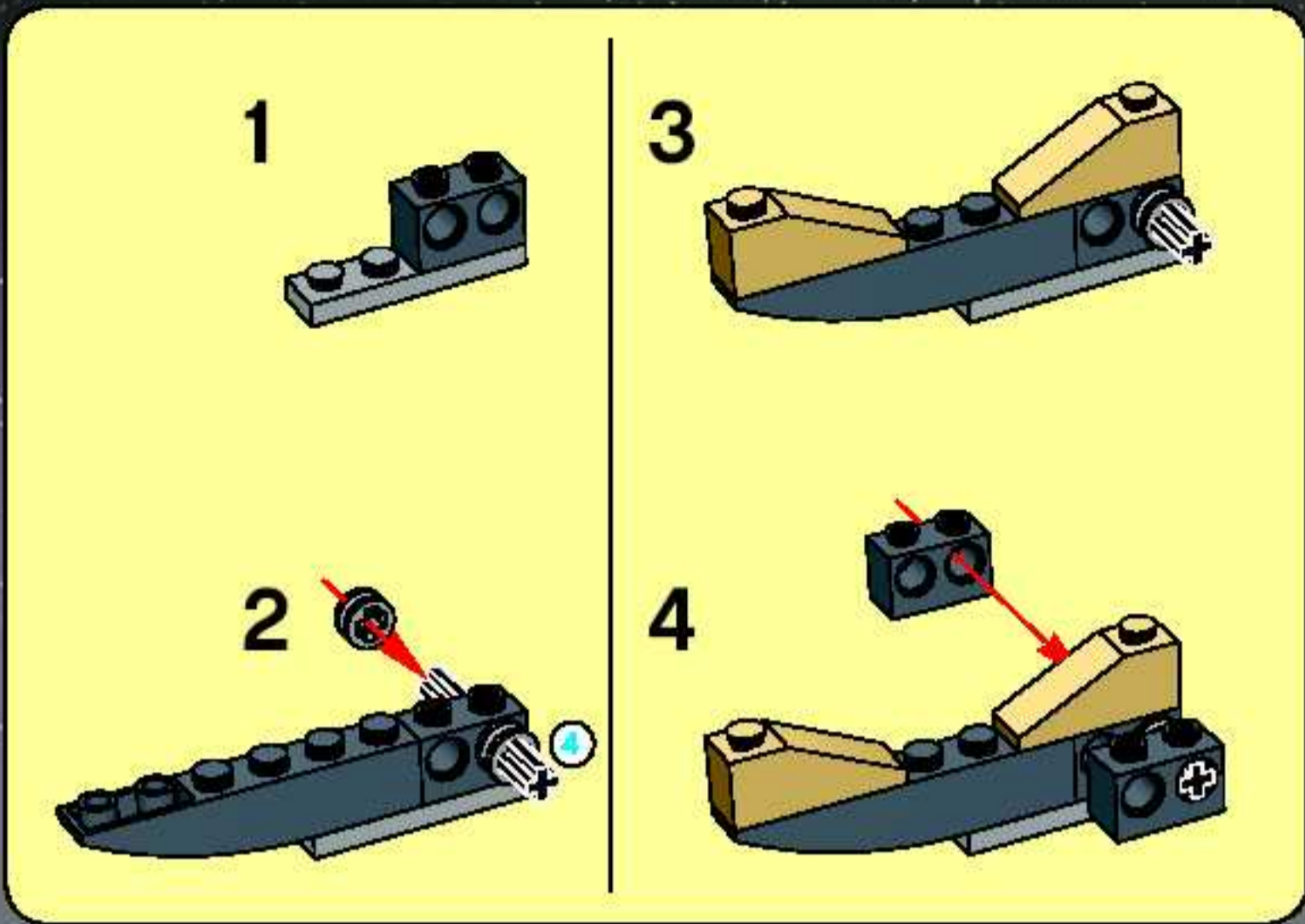

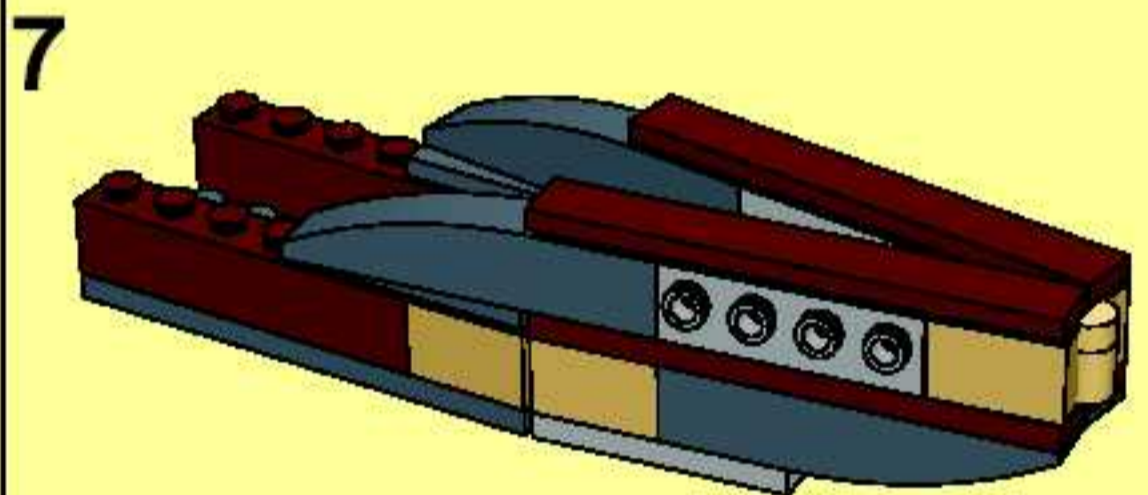
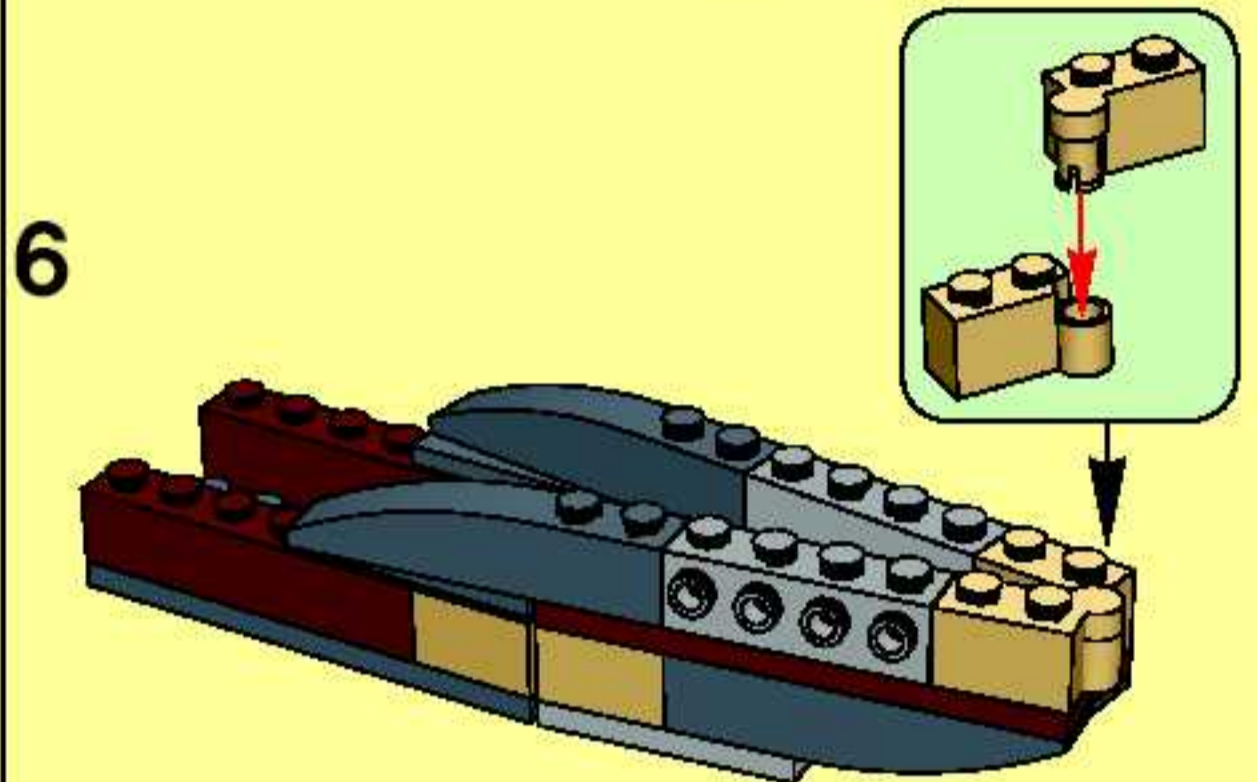
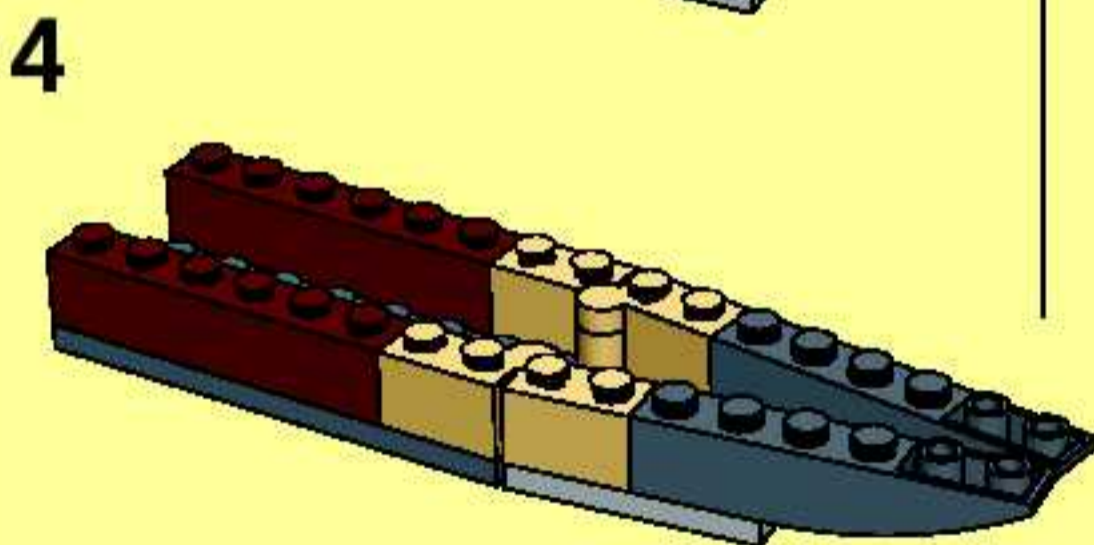
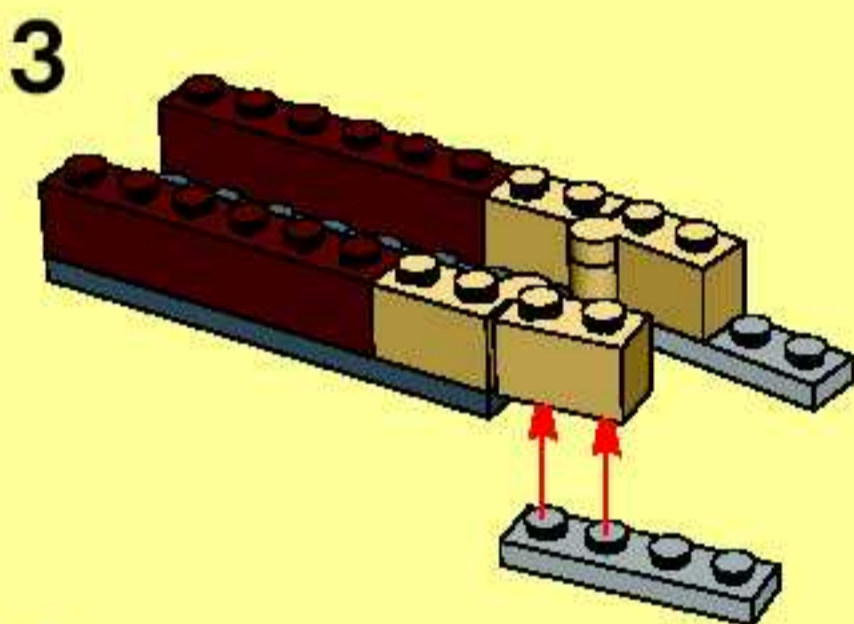
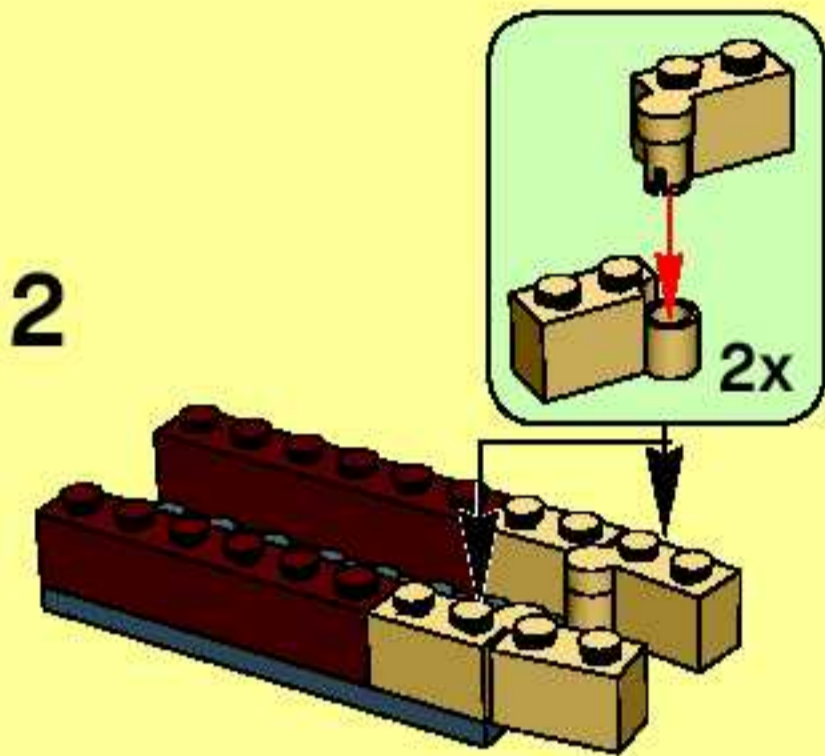
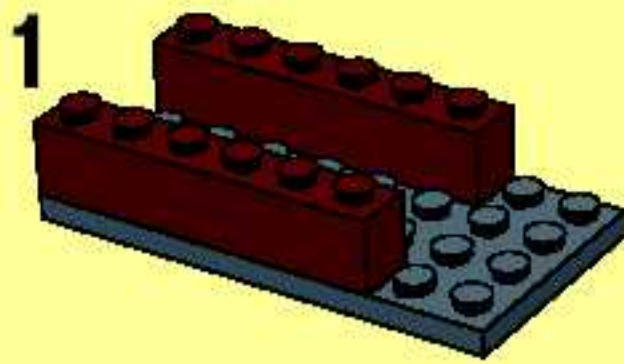

6

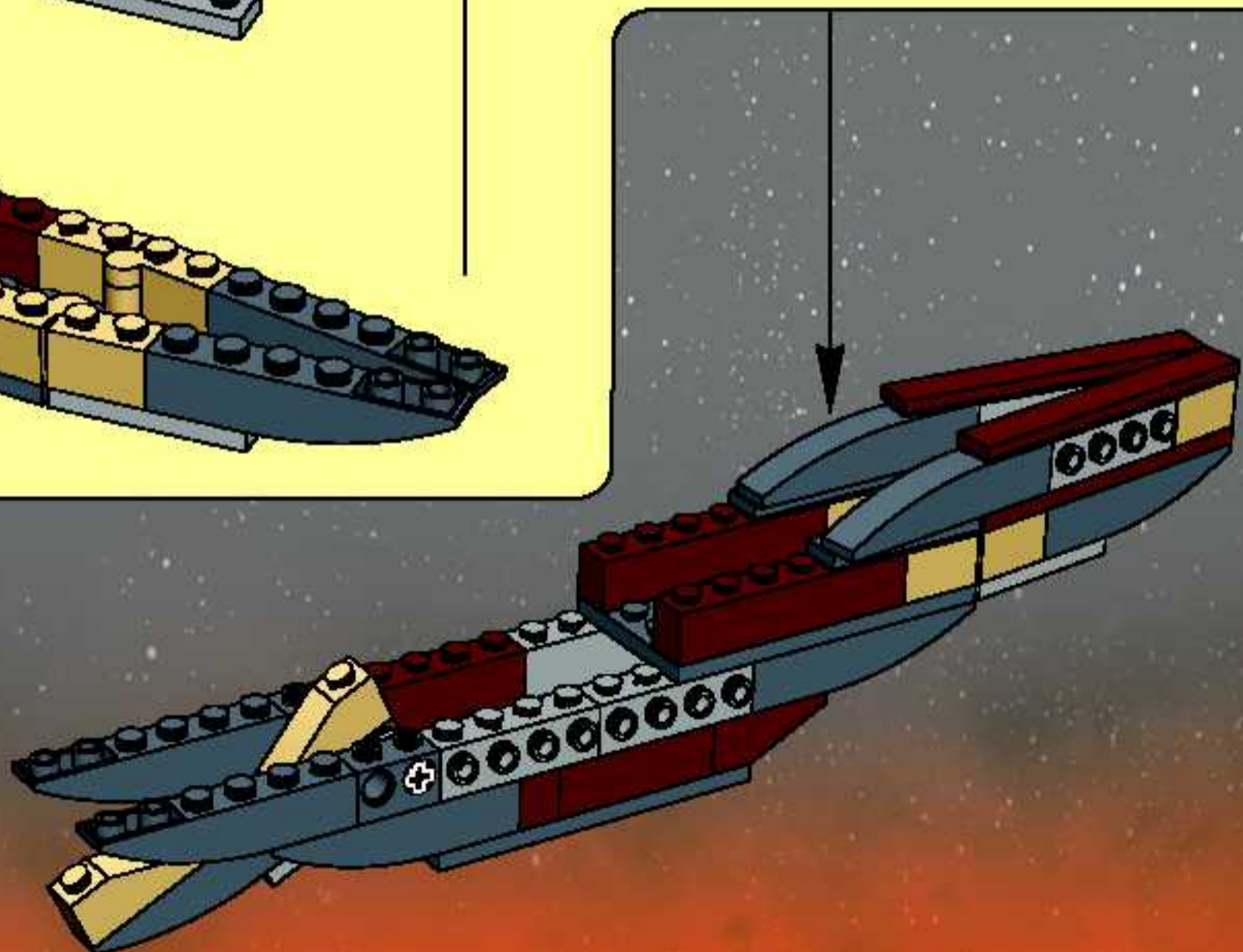

1

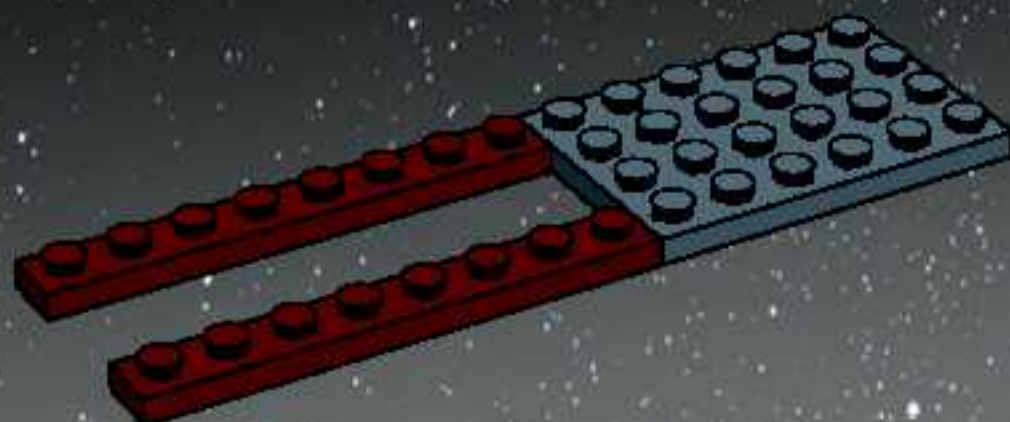

2

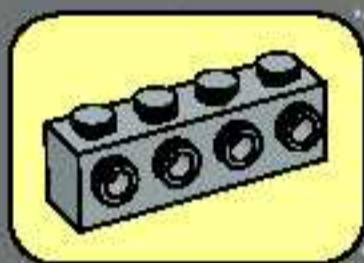
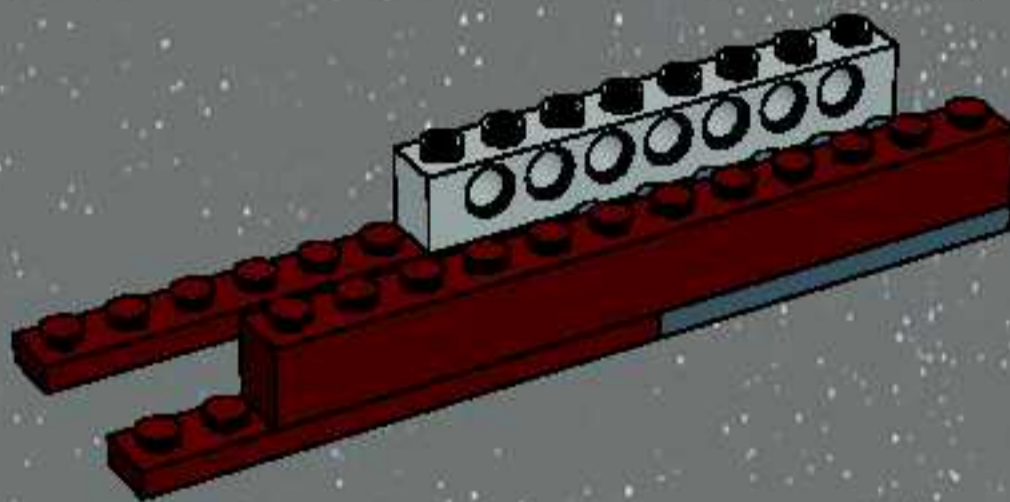

3

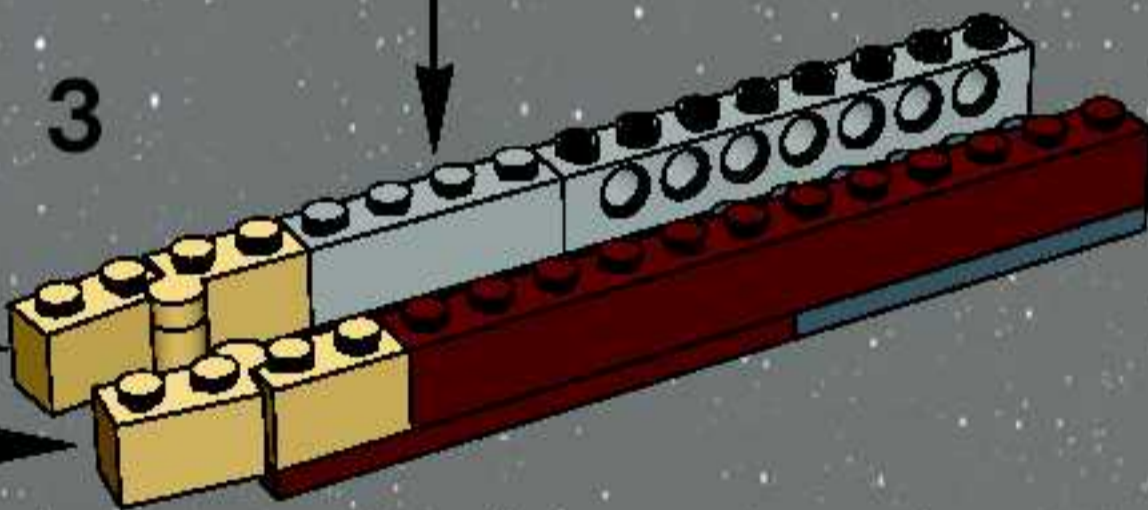
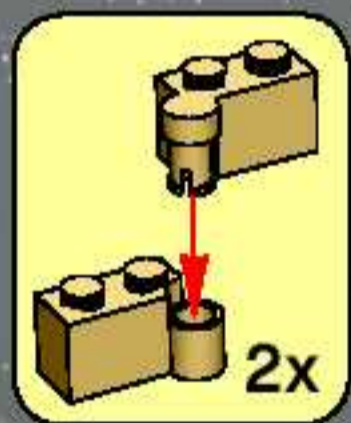

4

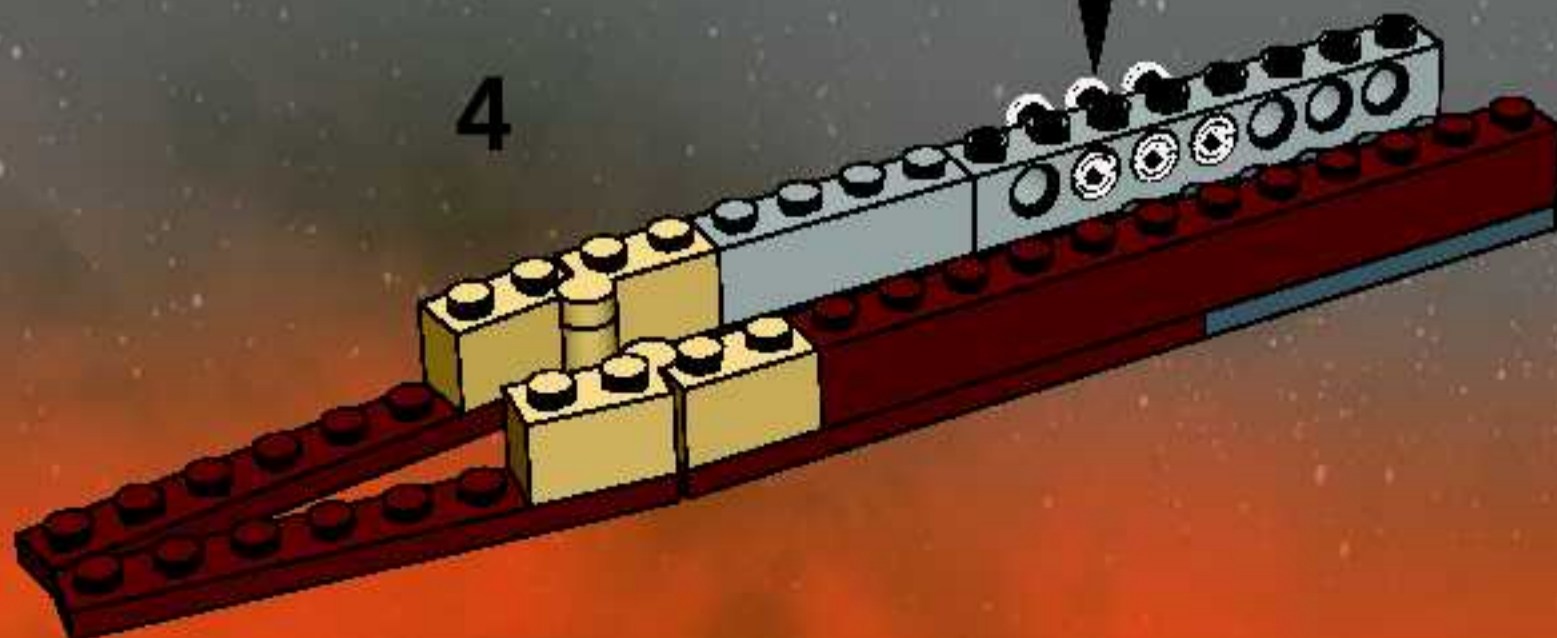

5



6

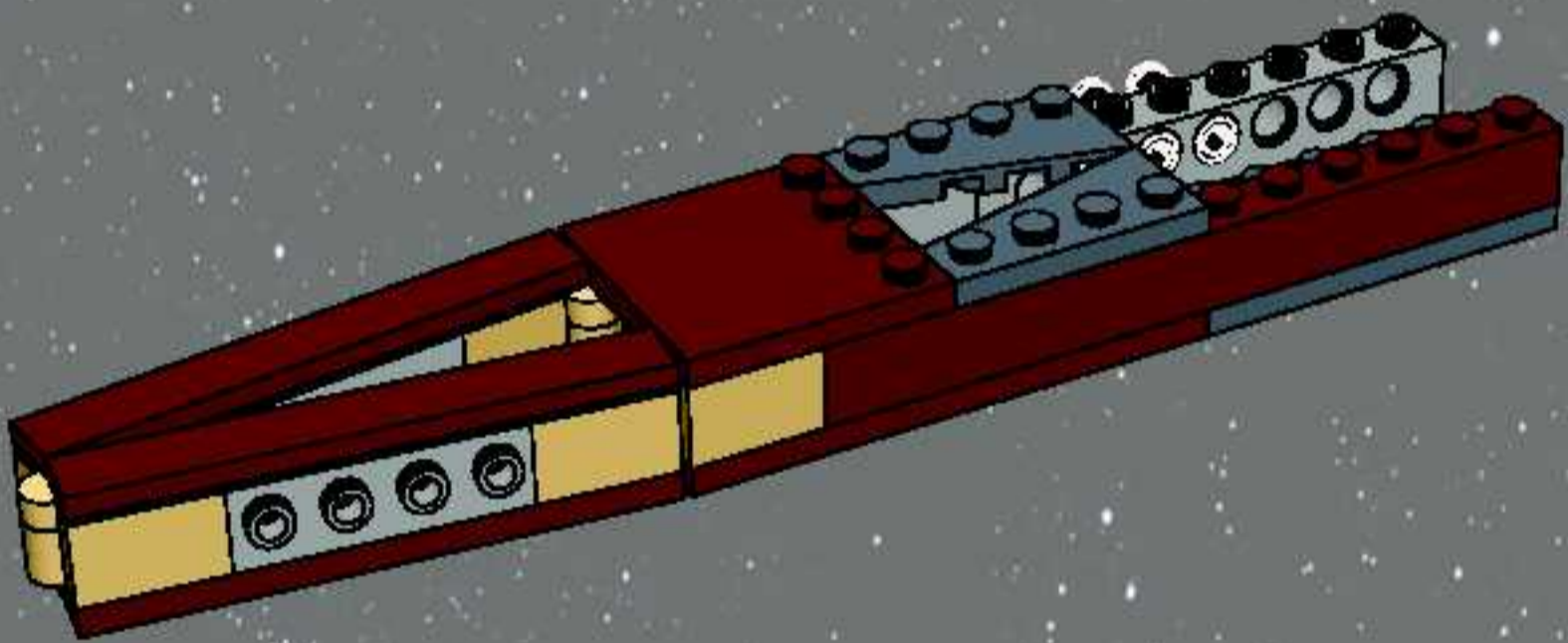

7

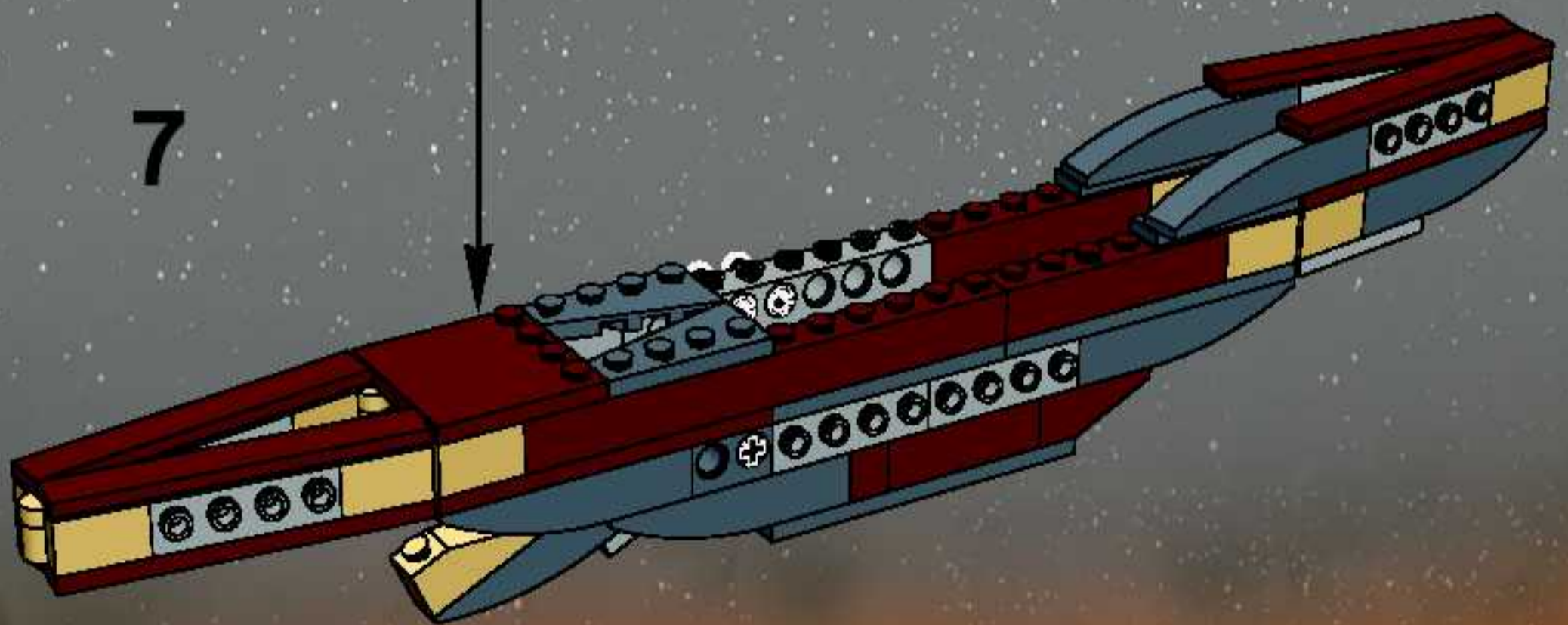

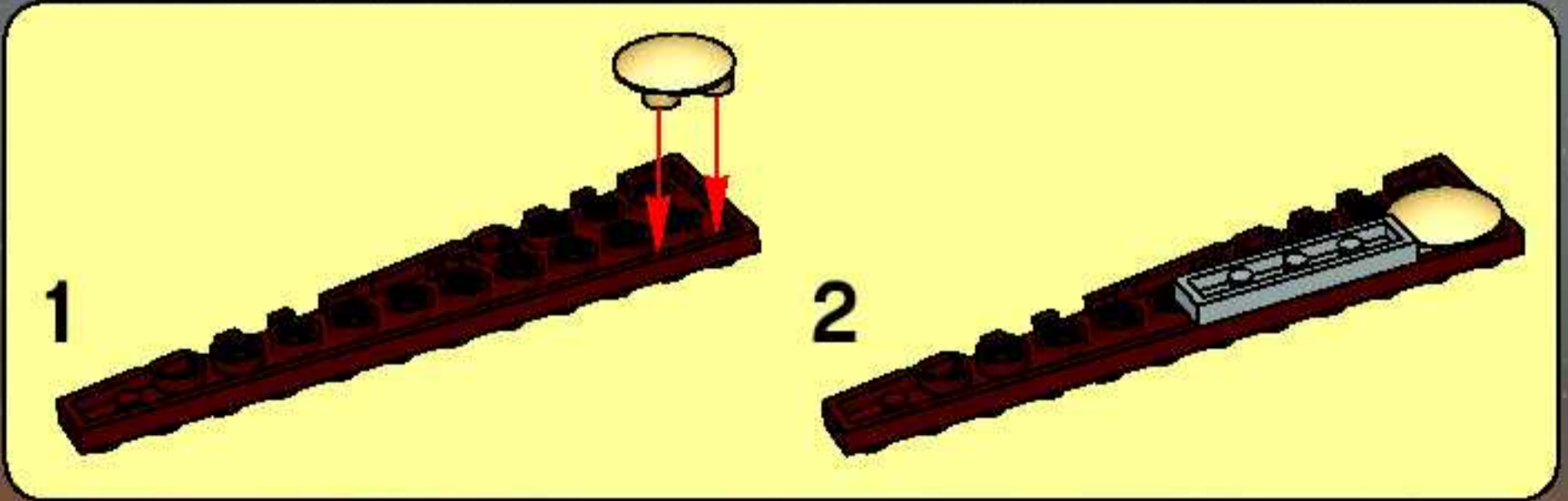
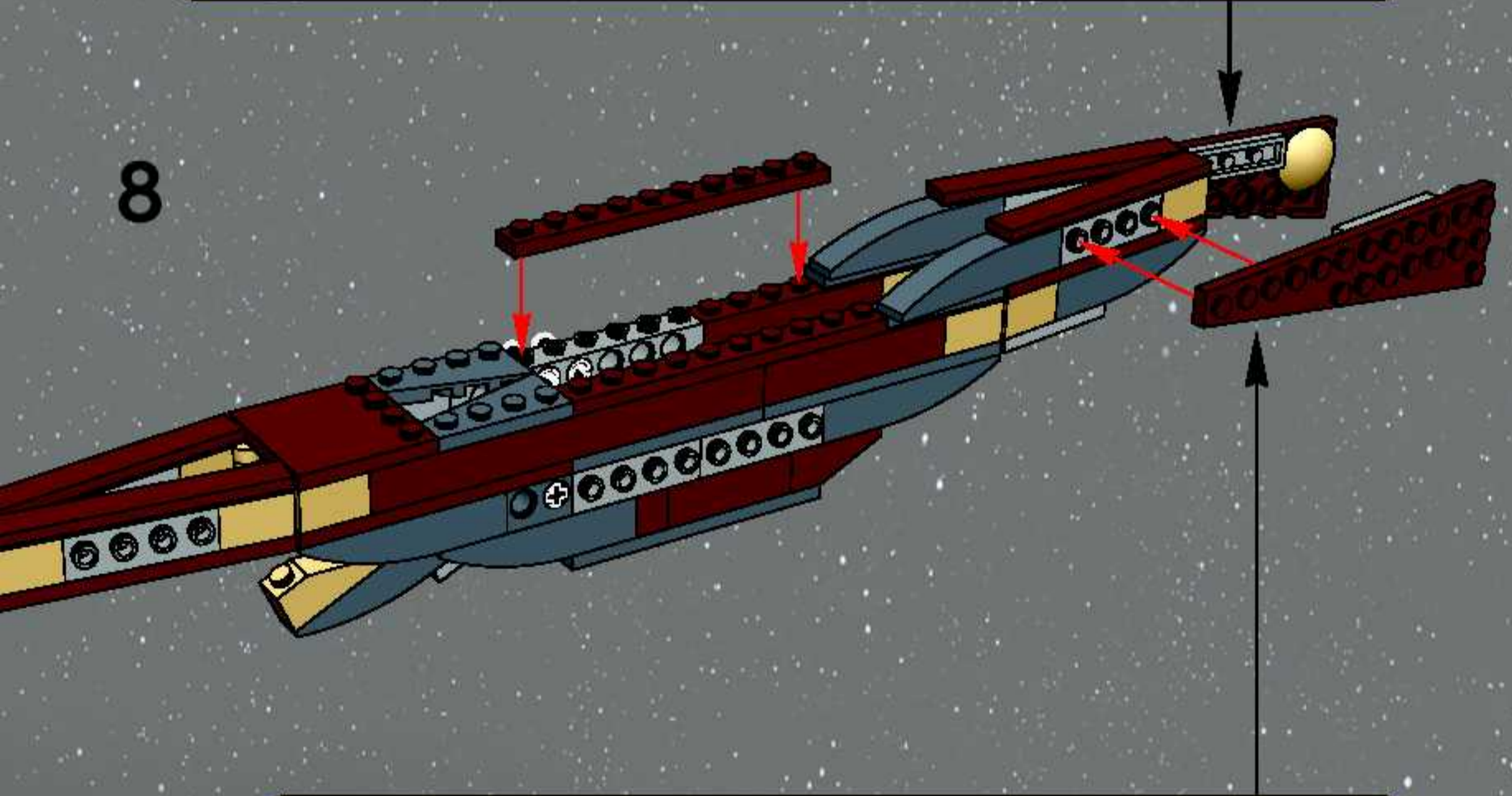
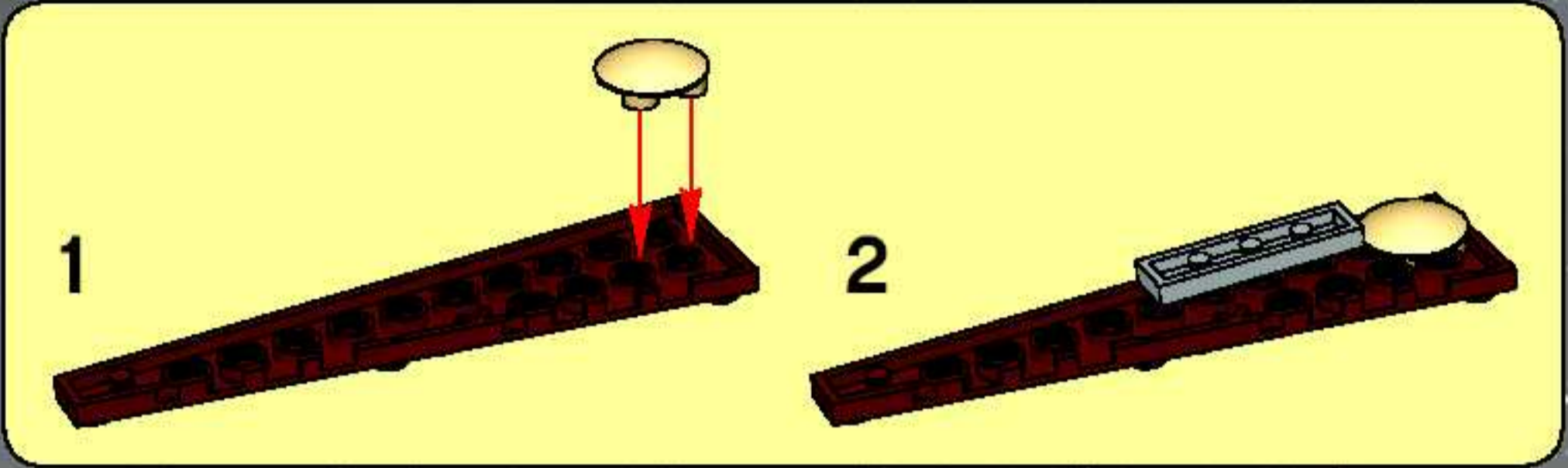

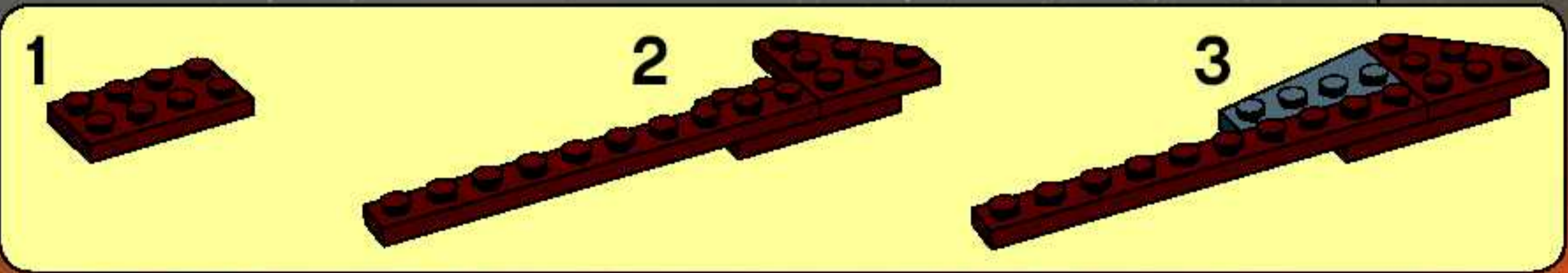
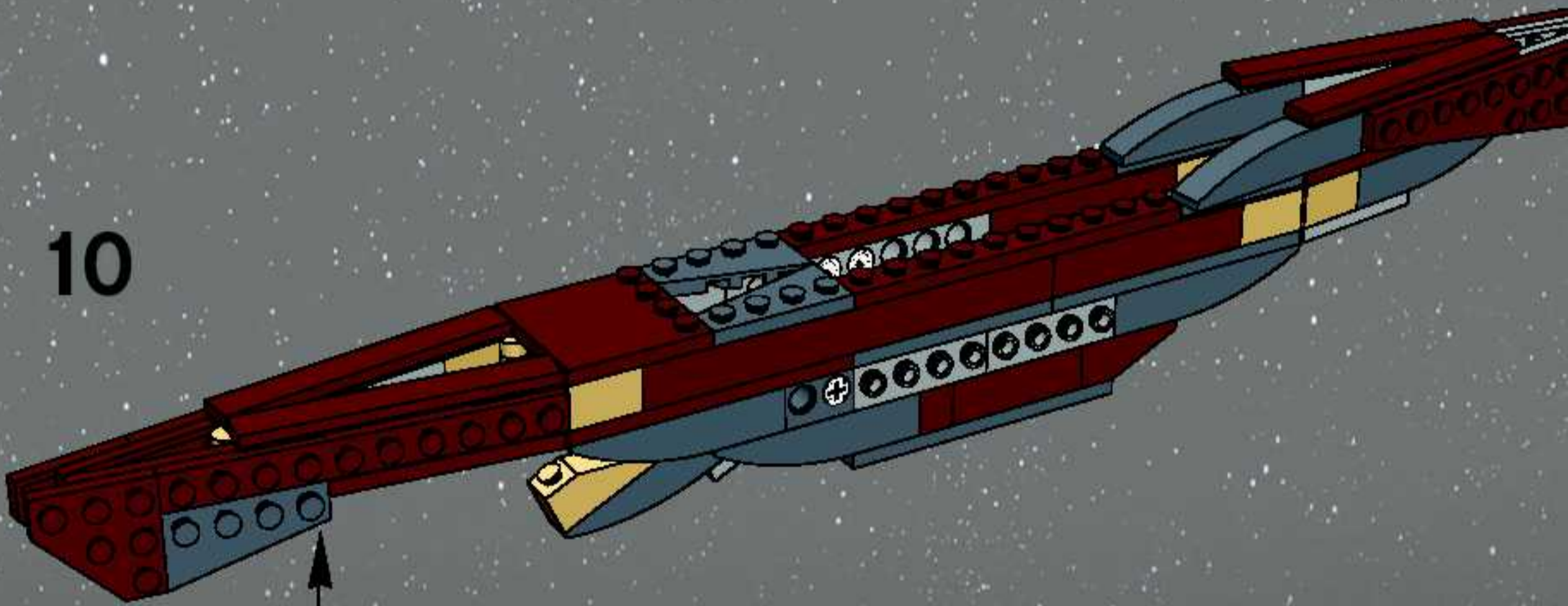
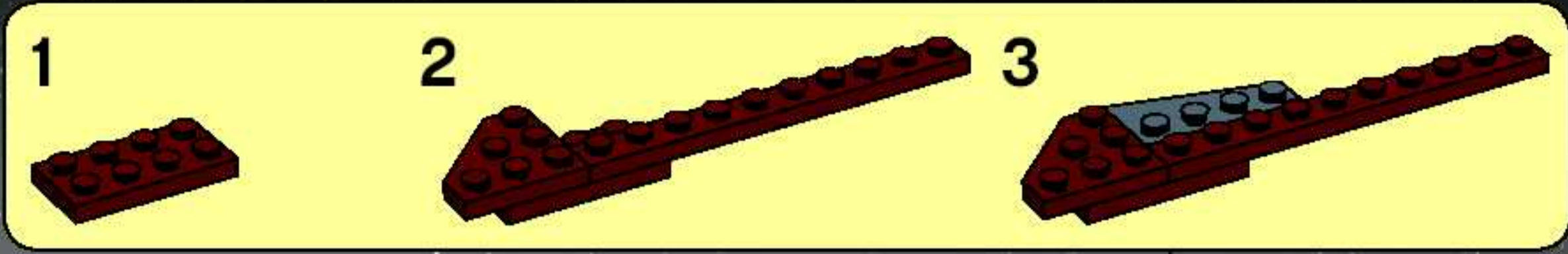

11



12

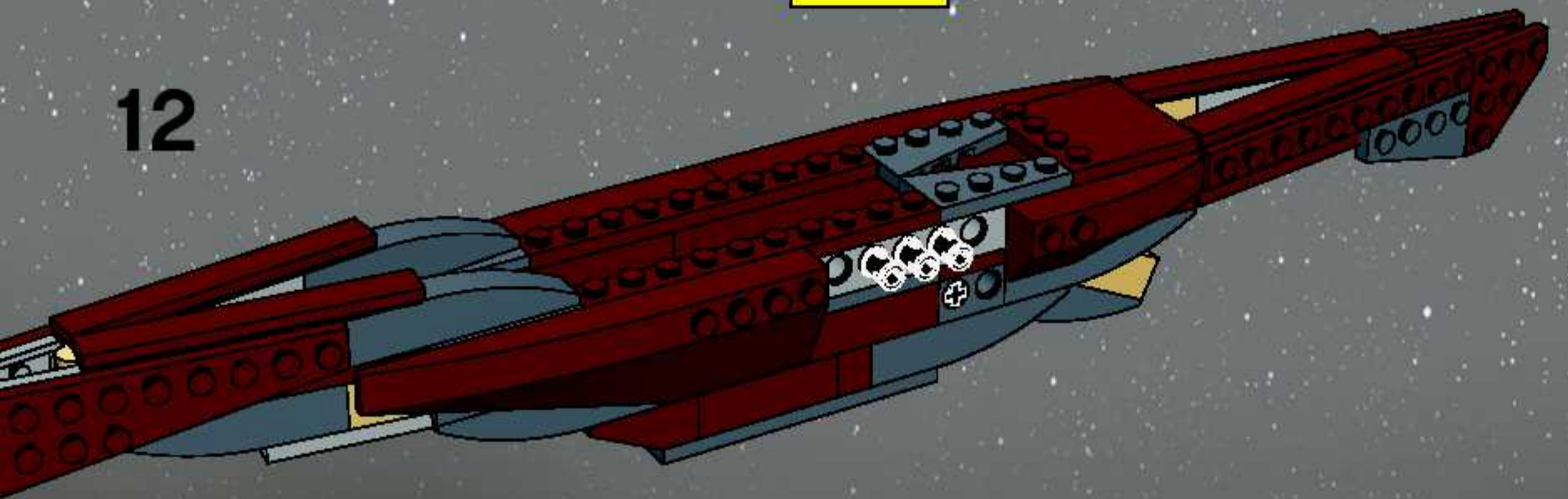



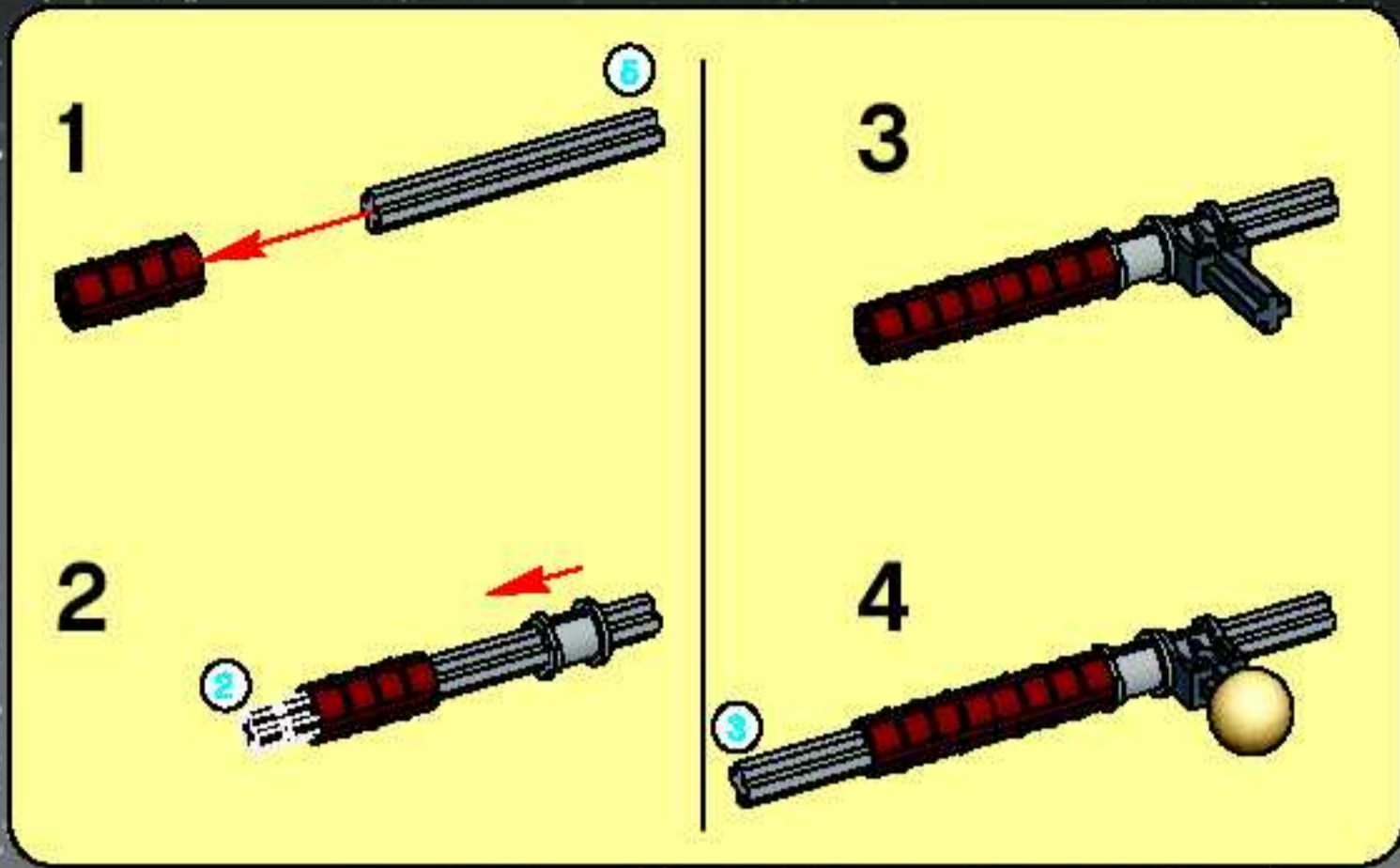

13

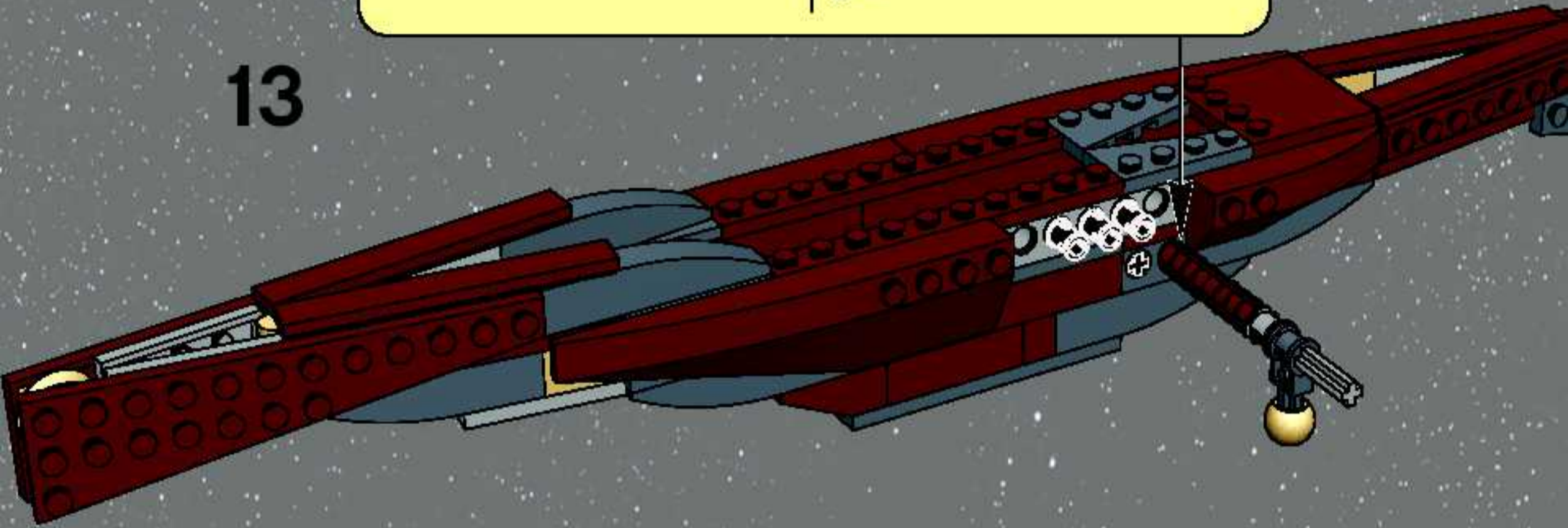

15

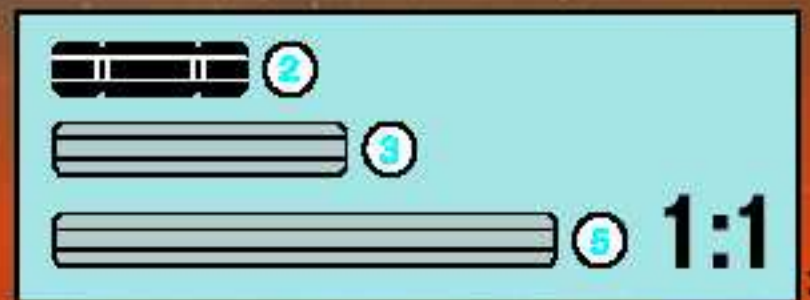

16

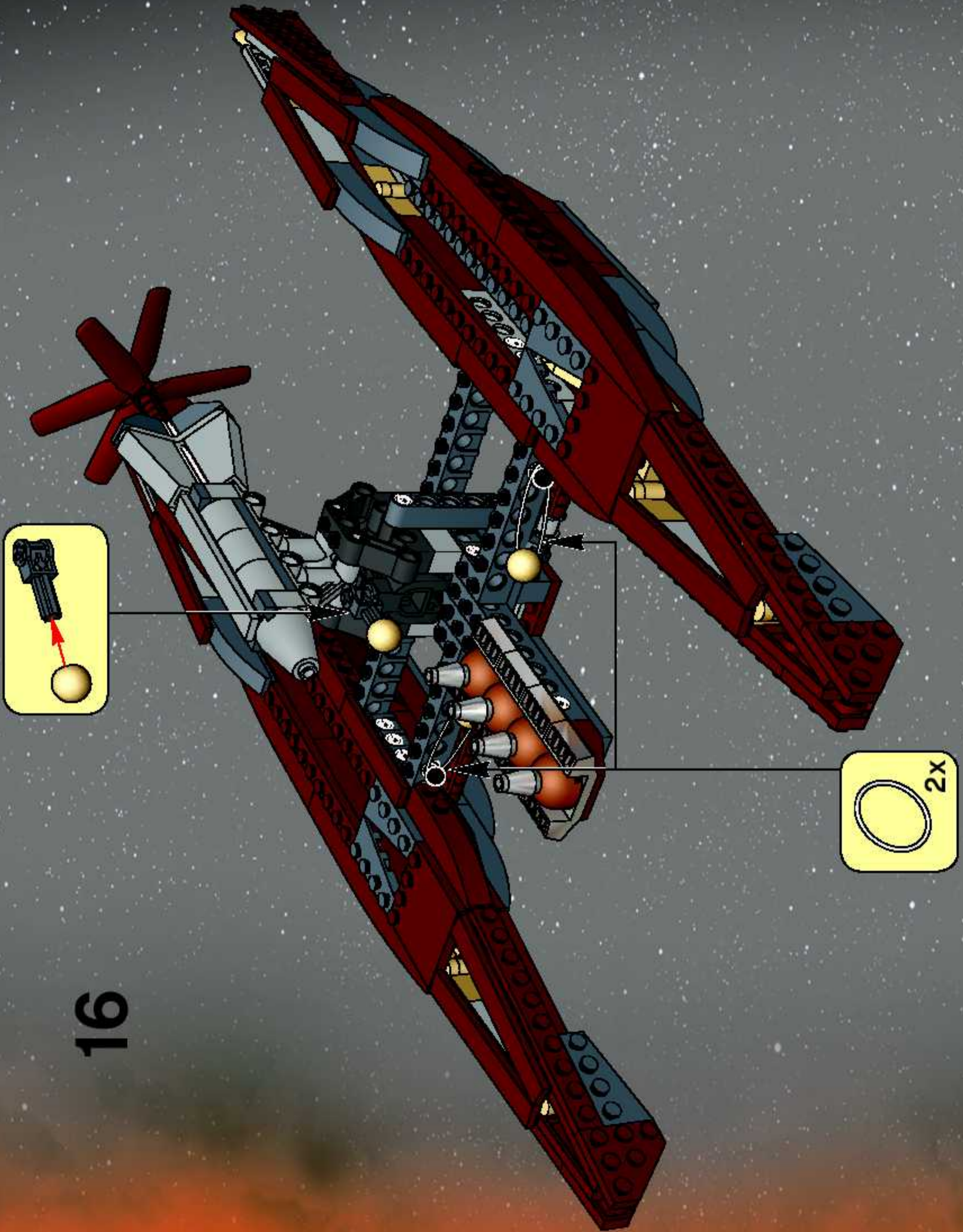

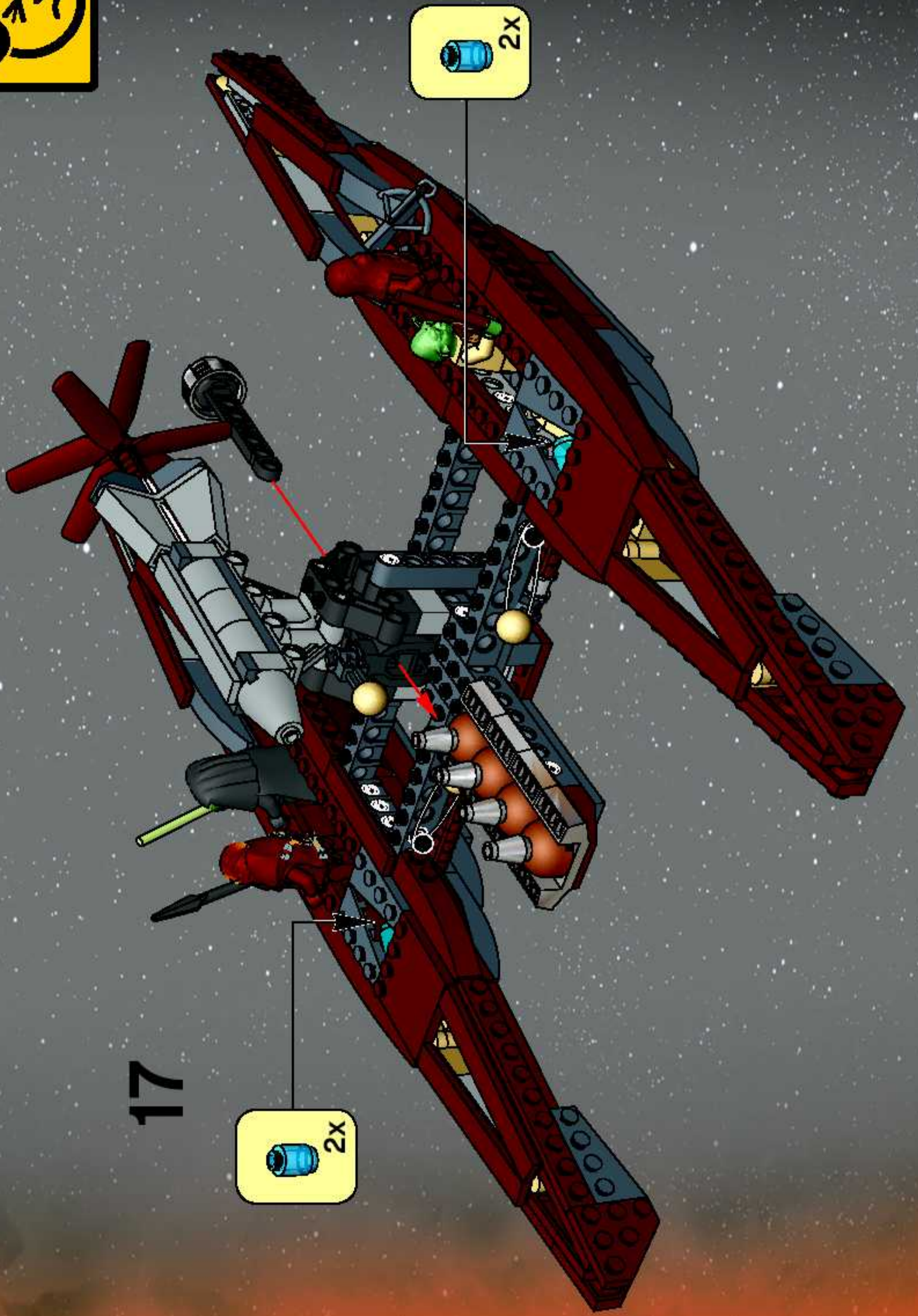

17



7256  
Jedi Starfighter™  
and Vulture Droid™



7259  
Arc-170 Starfighter™



7251  
Darth Vader™  
Transformation



7261 Clone Turbo Tank™

7250 Clone  
Scout Walker™

• When no longer in use, please dispose of the element in an environmentally responsible manner

• Lorsque l'élément est hors d'usage, veuillez s.v.p. le jeter d'une manière responsable sans nuire à l'environnement

• Antes de arrojar a la basura, cuida las normas ambientales



7257 Ultimate Lightsaber™ Duel



7252 Droid Tri-fighter™



7255 General Grievous™ Chase



7260 Wookiee Catamaran™



7258 Wookiee™ Attack



# Win! Gagne !



## FREE!

- Each LEGO Magazine Features...
- Awesome creations by Kids like you!
  - Cool Comics & Stories
  - Building Tips & Ideas
  - Special Offers & Contest to WIN Prizes!

## GRATUIT !

- Chaque Magazine LEGO offre...
- Des créations épatantes par des jeunes comme toi !
  - Des bandes dessinées et des récits super cool
  - Des idées de construction
  - Des offres spéciales et des concours pour gagner des prix !

### WIN LEGO® PRODUCTS

Log on to [www.acnielsen.aim.dk/LEGO](http://www.acnielsen.aim.dk/LEGO) for further instructions.

### GAGNE DES PRODUITS LEGO®

Visite [www.acnielsen.aim.dk/LEGO](http://www.acnielsen.aim.dk/LEGO) pour plus d'informations.

### ESTIMADO USARIO LEGO®

Al contestar algunas preguntas en ingles, frances, aleman o japonés en el sitio [www.acnielsen.aim.dk/LEGO](http://www.acnielsen.aim.dk/LEGO), podras participar en el sorteo de algunas valiosos premios LEGO®.

[www.acnielsen.aim.dk/LEGO](http://www.acnielsen.aim.dk/LEGO)

## Join Today!

## Abonne-toi dès aujourd'hui !

# 1-866-534-6258

## www.LEGOclub.com



**YES! I WANT TO JOIN THE LEGO® CLUB!**

This coupon is good for 1 **FREE** 2-year Club membership. Additional kids may sign up for \$7.95 in the US and in Canada 10.70 (including taxes).

**PLEASE PRINT IN ALL CAPITAL LETTERS**

**OUI! JOIGNEZ-MOI AU CLUB LEGO® !**

Ce coupon est valide pour 1 abonnement **GRATUIT** de 2 ans. Enfants additionnels peuvent s'inscrire pour 10,70 \$ (taxes incluses).

**S.V.P. IMPRIMER EN LETTRES MAJUSCULES.**

B125

Name/Nom \_\_\_\_\_ Age \_\_\_\_\_  Français  English

Address/Adresse \_\_\_\_\_  Girl/Fille  Boy/Garçon

City/Ville \_\_\_\_\_ State/Prov. \_\_\_\_\_ Postal Code Code Postal \_\_\_\_\_

E-mail Address/Courriel \_\_\_\_\_ Date of Birth Date de Naissance \_\_\_\_/\_\_\_\_/\_\_\_\_  
M D/Y Y/A

Parent's Signature/Signature d'un parent \_\_\_\_\_



Mail to/Poster à:  
**LEGO Club**  
P. O. Box 1157  
Enfield, CT  
06083-1157

Offer limited to residents of US and Canada. No photocopies will be accepted. Offer limited to two free memberships per family, group or organization. Please allow 4-6 weeks for delivery of your first mailing.  
 Offre limitée pour résidents du US et Canada. Photocopies ne seront pas acceptées. Offrir limitée à deux abonnements gratuits par famille, groupe, ou organisation. Allouez 4-6 semaines pour la première livraison.



# SHOP at HOME

## The World's Biggest LEGO® Shop!



For a Free Catalog  
in the U.S. and Canada,  
call toll-free:  
**1-800-446-8107**  
Or go online:  
**www.LEGOshop.com/catalog**

Pour obtenir un Catalogue  
**GRATUIT** aux États-Unis  
et au Canada,  
téléphonez sans frais au :  
**1-800-267-5346**  
Ou venez en ligne sur :  
**www.LEGOshop.com/catalog**

LEGO, the LEGO logo are trademarks of the LEGO Group. ©2005 The LEGO Group.

### FREE LEGO® Catalog!

Please print with a pen in capital letters.

First Name / Prénom \_\_\_\_\_

Last Name / Nom \_\_\_\_\_

Address / Adresse \_\_\_\_\_

City / Ville \_\_\_\_\_ State / Prov \_\_\_\_\_ Zip Code / Code Postal \_\_\_\_\_

Phone (optional) / No de téléphone (optionnel) \_\_\_\_\_

Email (optional) / Courriel (optionnel) \_\_\_\_\_

Check Below / Indiquer ci-bas

I speak English

Je parle Français

Boy/Garçon

Girl/Fille

### Catalogue LEGO® Gratuit!

S.V.P. Écrire en lettres majuscules avec un stylo à bille noir.

CRBP05



U.S. and Canada only  
É.-U. et Canada seulement

Please allow 2-4 weeks for delivery.  
Veuillez s.v.p. allouer 2 à 4 semaines pour l'expédition.

Mail to/Poster à:



P. O. Box 1221  
EnField, CT 06083-1221



# STAR WARS

## THE VIDEO GAME

4276590  
©2005 The LEGO Group.



LEGO, the LEGO logo and the Minifigure are trademarks of The LEGO Group. © 2004 The LEGO Group. © 2004 Lucasfilm Entertainment Company Ltd. or Lucasfilm Ltd. & © or TM as indicated. All rights reserved. Microsoft, Xbox and the Xbox logos are either registered trademarks or trademarks of Microsoft Corporation in the U.S. and/or in other countries and are used under license from Microsoft. All rights reserved. "PS" and "PlayStation" are registered trademarks of Sony Computer Entertainment Inc. All rights reserved. GAME BOY ADVANCE IS A TRADEMARK OF NINTENDO. The NVIDIA logo and "The way it's meant to be played" logo are registered trademarks or trademarks of NVIDIA Corporation.