

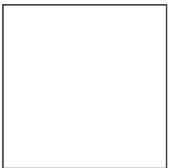

Booklet available in English on
Livret disponible en français sur
Folleto disponible en español en





WE'RE MAKING OUR PACKAGING MORE SUSTAINABLE

We're transitioning from single-use plastic to paper-based packaging. As we progress, you may find a mix of paper and plastic in our boxes.

NOUS RENDONS NOS EMBALLAGES PLUS DURABLES

Nous passons des emballages en plastique à usage unique aux emballages à base de papier. Durant la transition, vous pourriez trouver un mélange de papier et de plastique dans nos boîtes.

QUEREMOS HACER MÁS SUSTENTABLES NUESTROS MATERIALES DE EMBALAJE

Estamos cambiando las bolsas de plástico desechables por bolsas con base de papel. Conforme avanzamos en este propósito, puedes encontrar una mezcla de papel y de plástico en nuestras cajas.

LEGO.com/sustainable-packaging

LEGO® VIP

- 1.** SIGN UP
INSCRIVEZ-VOUS
REGÍSTRATE

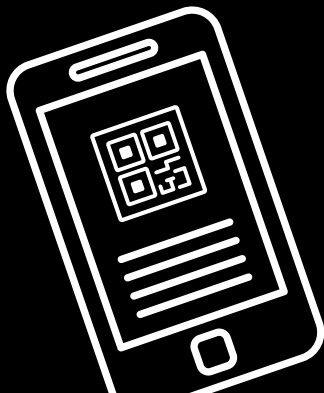

- 2.** EARN POINTS
FOR PURCHASES
GAGNEZ DES POINTS
POUR VOS ACHATS
GANA PUNTOS POR
TUS COMPRAS

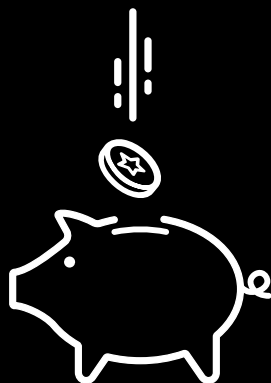

- 3.** REDEEM POINTS FOR REWARDS, EXPERIENCES,
DISCOUNTS & MORE
ÉCHANGEZ DES POINTS CONTRE DES RÉCOMPENSES,
DES EXPÉRIENCES, DES RÉDUCTIONS ET PLUS ENCORE
CANJEA PUNTOS POR RECOMPENSAS, EXPERIENCIAS,
DESCUENTOS Y MUCHO MÁS

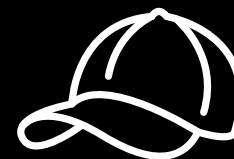
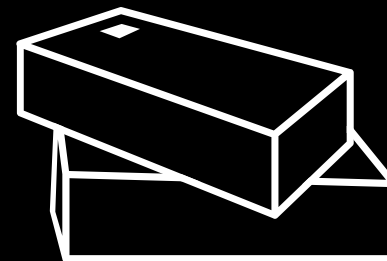
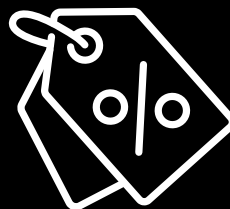



TO THE FIRST AVENGER

Fighting dictators and Hydra villains on earth and in space may have defined Steve Rogers as Captain America but he embodied the title all along. From the skinny boy with a big heart to the first Avenger in the Infinity Saga, Rogers' journey, from humble roots in WWII-era Brooklyn to saving the universe (actually, several) from Thanos decades later, would have looked dramatically different without his sturdy shield.

"I can do this all day." – Steve Rogers (Captain America)

AU PREMIER AVENGER

Combattre les dictateurs et les méchants d'Hydra sur Terre et dans l'espace a peut-être conféré à Steve Rogers le titre de Capitaine America, mais il a toujours incarné ce rôle. Du garçon chétif au grand cœur au premier Avenger de *La saga de l'Infini*, Rogers, de ses humbles racines dans le Brooklyn de la Seconde Guerre mondiale à la protection de l'univers (en fait, de plusieurs) contre Thanos des décennies plus tard, aurait eu un parcours radicalement différent sans son solide bouclier.

« Je ferais ça toute la journée. » – Steve Rogers (Capitaine America)

AL PRIMER VENGADOR

Puede ser que luchar contra dictadores y villanos de Hydra en la Tierra y en el espacio haya definido la figura de Steve Rogers como Capitán América, pero es justo reconocer que siempre encarnó el título. El viaje de Rogers, un flaquito de gran corazón que se convertiría en el primer Vengador de la Saga Infinity, desde sus humildes raíces en el Brooklyn de la Segunda Guerra Mundial hasta, décadas después, salvar nuestro universo (o, en realidad, varios de ellos) del destino que perseguía Thanos, habría sido radicalmente distinto sin su inquebrantable escudo.

"Seguiría todo el día". – Steve Rogers (Capitán América)



A STARK INVENTION

"Vibranium. It's stronger than steel and a third of the weight. It's completely vibration absorbent." Howard Stark's one-of-a-kind shield prototype catches Rogers' attention during a walkthrough of Stark's combat equipment facilities. After an impromptu test involving Agent Peggy Carter, Rogers sees its potential. Forged from the rarest metal on earth, the shield is virtually indestructible. Its inherent strength and flexibility double as a forceful source of protection and a versatile combat weapon. For *Captain America: The First Avenger*, three model variants were created for various uses in the movie. A stunt version made of synthetic rubber, a costume version made of aluminum and fiberglass, and an aluminum version for close-up shots.

UNE INVENTION SIGNÉE STARK

« En vibranium. C'est plus résistant que l'acier pour un tiers du poids. Ce matériau absorbe complètement les vibrations. » Le prototype de bouclier unique d'Howard Stark attire l'attention de Rogers lors d'une visite des installations d'équipement de combat de Stark. Après un test spontané impliquant l'agente Peggy Carter, Rogers voit son potentiel. Forgé à partir du métal le plus rare sur Terre, le bouclier est pratiquement indestructible. Sa force et sa flexibilité inhérentes en font une source de protection redoutable et une arme de combat polyvalente. Pour *Capitaine America : Le premier vengeur*, trois modèles ont été créés pour diverses utilisations dans le film. Une version en caoutchouc synthétique pour les cascades, une version en aluminium et fibre de verre pour le costume, et une version en aluminium pour les gros plans.

UN INVENTO DE STARK

"Vibranium. Más fuerte que el acero y pesa un tercio. Absorbe las vibraciones totalmente". El exclusivo prototipo de escudo de Howard Stark llama la atención de Rogers durante una visita a las instalaciones militares de Stark. Luego de una prueba improvisada en la que participa la agente Peggy Carter, Rogers ve su potencial. Forjado a partir del metal más raro de la Tierra, el escudo es prácticamente indestructible. Su fuerza y flexibilidad inherentes sirven al mismo tiempo como fuente de protección y como versátil arma de combate. Para *Capitán América: El primer Vengador*, se crearon tres variantes del modelo que recibieron diversos usos en la película. Una versión para los especialistas hecha de hule sintético, una versión de vestuario fabricada en aluminio y fibra de vidrio, y una versión de aluminio para los primeros planos.

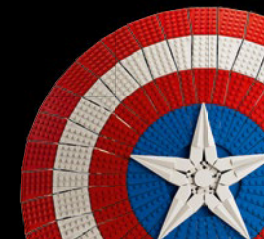

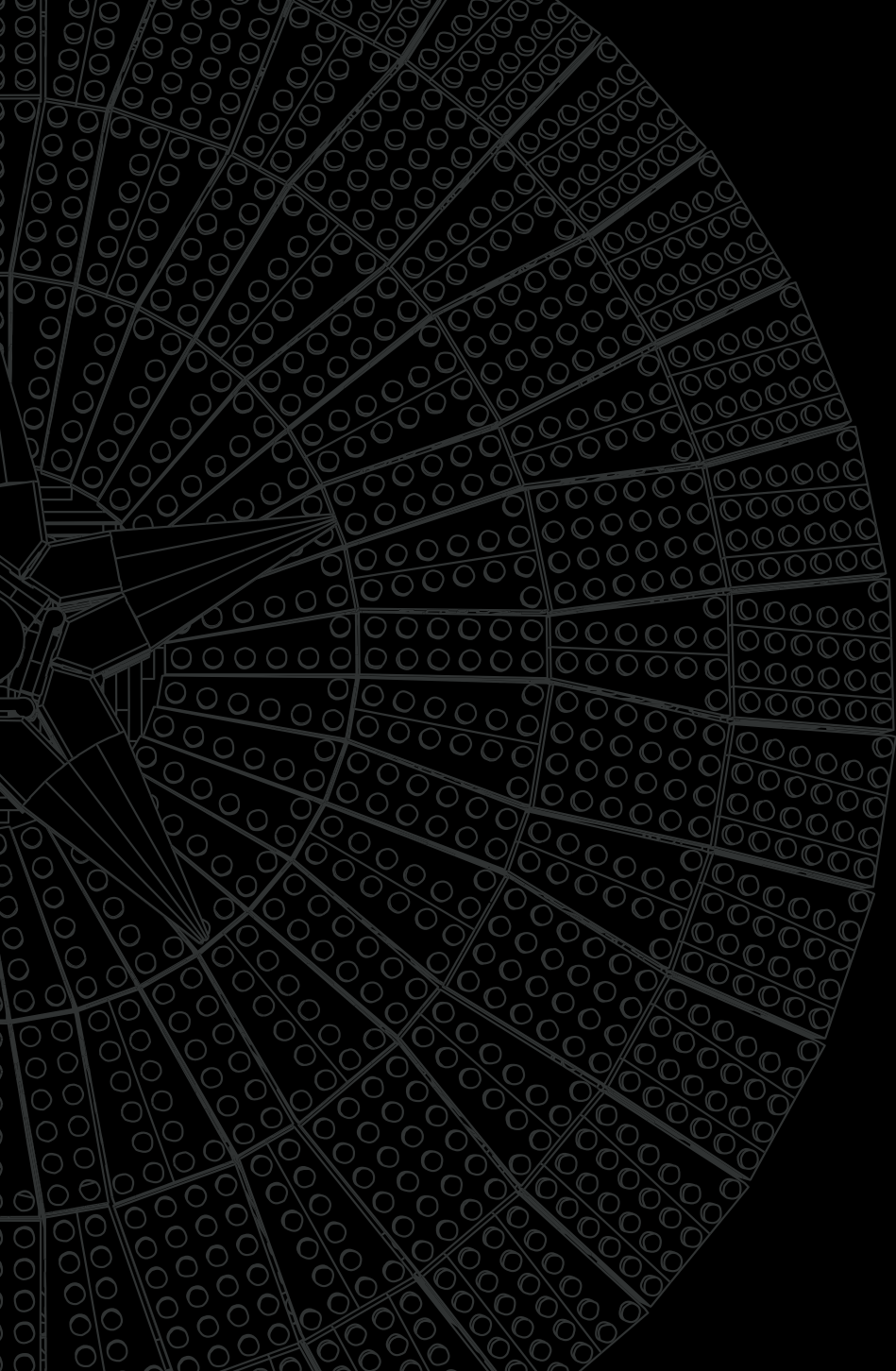

PUSHING THE LEGO® LIMITS

"Captain America's shield has been on our LEGO® Marvel wish list for a long time. Testing our skills, exploring new possibilities and pushing the limits of what we can do, within the LEGO System, fits so well with the Captain America character. For a Marvel fan, it's like building the Holy Grail – you really want to get it right, but it just seemed like an impossible task. Previous sketch models came close but still fell a bit short of what we wanted to achieve. Well, 'Cap' has never let 'impossible' stop him, so in that spirit, I started listing and drawing all the solutions I could imagine."

REPOUSSER LES LIMITES DE LEGO®

« Le bouclier de Capitaine America figure depuis longtemps sur notre liste de souhaits LEGO® Marvel. Le test de nos compétences, l'exploration de nouvelles possibilités et le dépassement des limites de ce que nous pouvons faire avec le système LEGO concordent si bien avec le personnage de Capitaine America. Pour un amateur de Marvel, c'est comme construire le Saint Graal : on veut vraiment réussir, mais la tâche semble impossible. Les modèles d'exemple précédents étaient assez fidèles, mais n'étaient toujours pas à la hauteur de ce que nous voulions réaliser. Mais l'impossible n'a jamais arrêté "Cap", alors j'ai commencé à énumérer et à dessiner toutes les solutions que je pouvais imaginer. »

MÁS ALLÁ DE LOS LÍMITES DE LEGO®

"El escudo del Capitán América lleva mucho tiempo en nuestra lista de deseos para LEGO® Marvel. Poner a prueba nuestras habilidades, explorar nuevas posibilidades y superar los límites de lo que podemos hacer en el ámbito del sistema LEGO se ajusta muy bien al personaje del Capitán América. Para un fan de Marvel, es como construir el santo grial: realmente quieres hacerlo bien, pero parece una tarea imposible. Los anteriores modelos preliminares se acercaban bastante a lo que queríamos lograr, pero se quedaban un poco cortos. Lo cierto es que el Capitán nunca dejó que lo 'imposible' lo detuviera, así que, con el mismo espíritu, comencé a escuchar y dibujar todas las soluciones que se me ocurrieron".

BEING CREATIVE WITH WHAT'S AVAILABLE

It took some unconventional thinking and techniques to turn mostly square and angled LEGO® bricks into a clean, round and curved design. The underlying structure had to be rigid yet lightweight and the building experience intuitive and interesting. And we only wanted to use elements that already existed in the LEGO System, so fans can enjoy the feeling that they could have designed this, too.

ÊTRE CRÉATIF AVEC CE QUI EST DISPONIBLE

Il a fallu une réflexion et des techniques non conventionnelles pour obtenir une conception nette, ronde et incurvée avec des briques LEGO®, principalement carrées et angulaires. La structure sous-jacente devait être rigide mais, légère, et l'expérience de construction devait être intuitive et intéressante. Nous voulions utiliser uniquement des éléments qui existaient déjà dans le système LEGO, afin que les amateurs puissent sentir qu'ils auraient pu le concevoir eux aussi.

CREATIVIDAD CON LO QUE TENÍAMOS DISPONIBLE

Necesitamos algunas ideas y técnicas poco convencionales para convertir los bricks LEGO®, principalmente cuadrados y angulosos, en un diseño limpio, redondo y curvo. La estructura subyacente tenía que ser rígida y ligera al mismo tiempo, y la experiencia de construcción debía ser intuitiva e interesante. Además, queríamos usar solo elementos que ya existieran en el sistema LEGO, de modo que los fans tuvieran la sensación de que ellos también podrían haber diseñado el modelo.



BUILDING OUTSIDE THE GRID

To explore the capabilities of the LEGO® system, we used engineering principles to calculate how the different parts could fit together legally. Odd angles or stretched compositions can stress the elements, so everything must fit the way the system is meant to be used to create a solid and durable design. The top cover plates must line up perfectly next to each other with the exact same gap in between the plates all the way around to obtain the iconic shape of the shield. The solution we ended up using ticks all those boxes and fits the tolerance of the elements.

CONSTRUIRE AU-DELÀ DES LIMITES

Afin d'explorer les capacités du système LEGO®, nous avons utilisé des principes d'ingénierie pour calculer comment les différentes pièces pouvaient parfaitement s'assembler. Des angles irréguliers ou des compositions étirées peuvent soumettre les éléments à une trop forte pression. Tout doit donc être conforme aux usages du système pour créer une conception solide et durable. Les plaques du dessus doivent être parfaitement alignées l'une à côté de l'autre et l'espace entre les plaques doit être exactement le même sur tout le pourtour afin de rendre la forme emblématique du bouclier. La solution que nous avons finalement retenue répond à toutes ces exigences et respecte la tolérance des éléments.

FUERA DE LOS LÍMITES DE LA TRAMA

Para explorar las posibilidades del sistema LEGO®, aplicamos principios de ingeniería que nos permitieron calcular cómo podían encajar legítimamente las distintas piezas. Los ángulos extraños, al igual que las composiciones forzadas, pueden sobrecargar los elementos, por lo que todo debe ajustarse a la forma en que se supone que debe usarse el sistema para crear un diseño robusto y duradero. Las cubiertas superiores deben alinearse perfectamente unas junto a otras, dejando exactamente el mismo espacio entre ellas a todo alrededor para obtener la inconfundible forma del escudo. La solución que acabamos adoptando cumple todos esos requisitos y se ajusta a la tolerancia de los elementos.

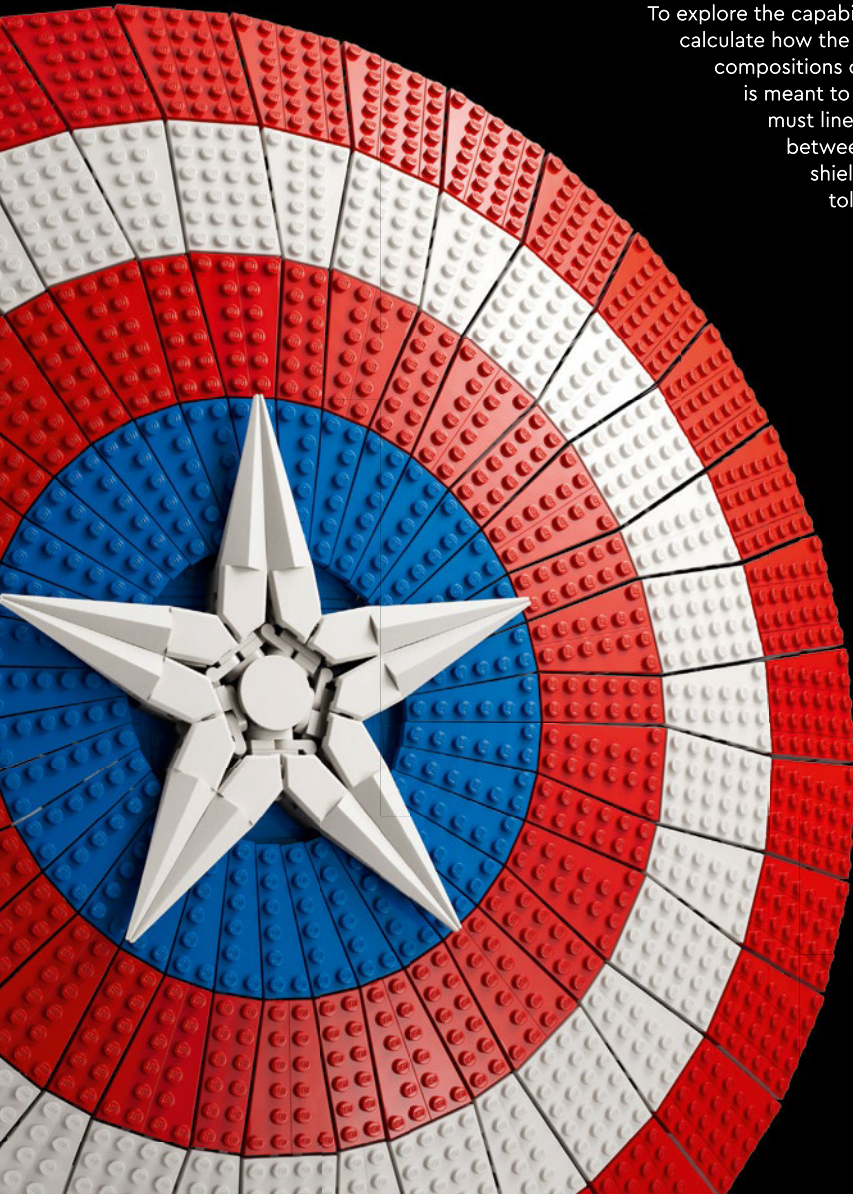



"I'M... CAPTAIN AMERICA."

"The star in the center completes the design inspired by the American flag. The star aligns with the border of the blue area in the middle, and we must have tested hundreds of combinations to get it right! Everything needs to play together to match the proportions and iconic feel of the shield. So, whichever Captain America you aspire to be, we hope you'll enjoy the experience."

- Mathias Julin, LEGO® Model Designer

« JE SUIS... CAPITAINE AMERICA. »

« L'étoile au centre complète le motif inspiré du drapeau américain. L'étoile doit s'aligner sur le contour de la zone bleue au milieu, et nous avons dû tester des centaines de combinaisons pour y parvenir ! Tout doit s'harmoniser pour reproduire les proportions et le caractère emblématique du bouclier. Alors, quel que soit le Capitaine America que vous souhaitez être, nous espérons que vous apprécierez l'expérience. »

- Mathias Julin, concepteur de modèles LEGO®

"SOY... EL CAPITÁN AMÉRICA".

"La estrella del centro completa el diseño, inspirado en la bandera de los Estados Unidos. Las puntas coinciden con el borde del área azul central, ¡y seguramente probamos cientos de combinaciones hasta que encontramos la mejor! Todo tiene que combinar para ajustarse a las proporciones y al carácter emblemático del escudo. Así que, sea cual sea el Capitán América que aspire a ser, esperamos que disfrutes de la experiencia".

- Mathias Julin, modelista de LEGO®

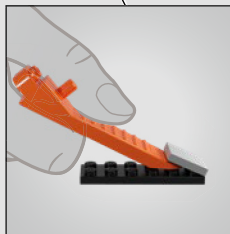
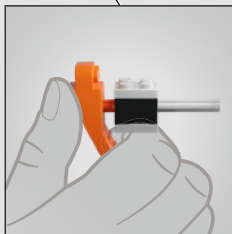
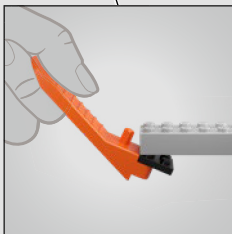
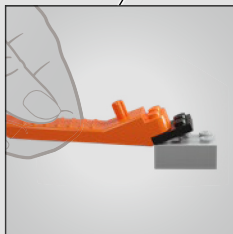
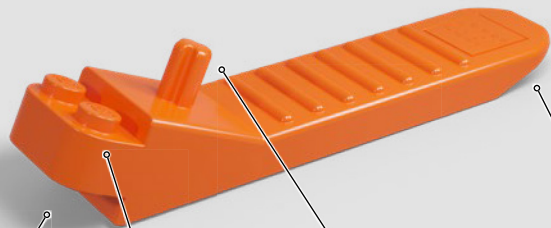

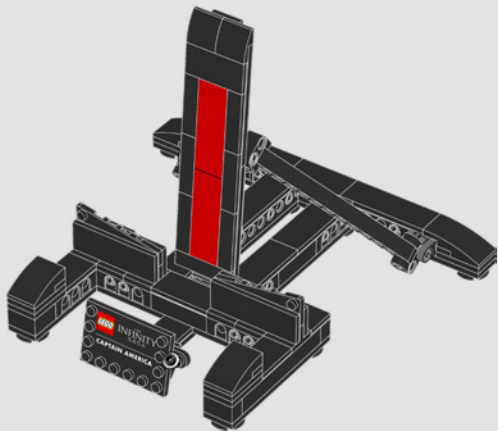
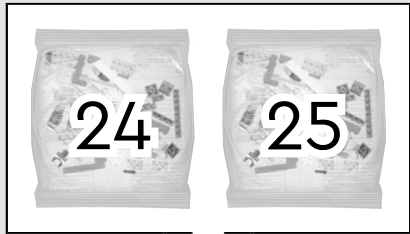
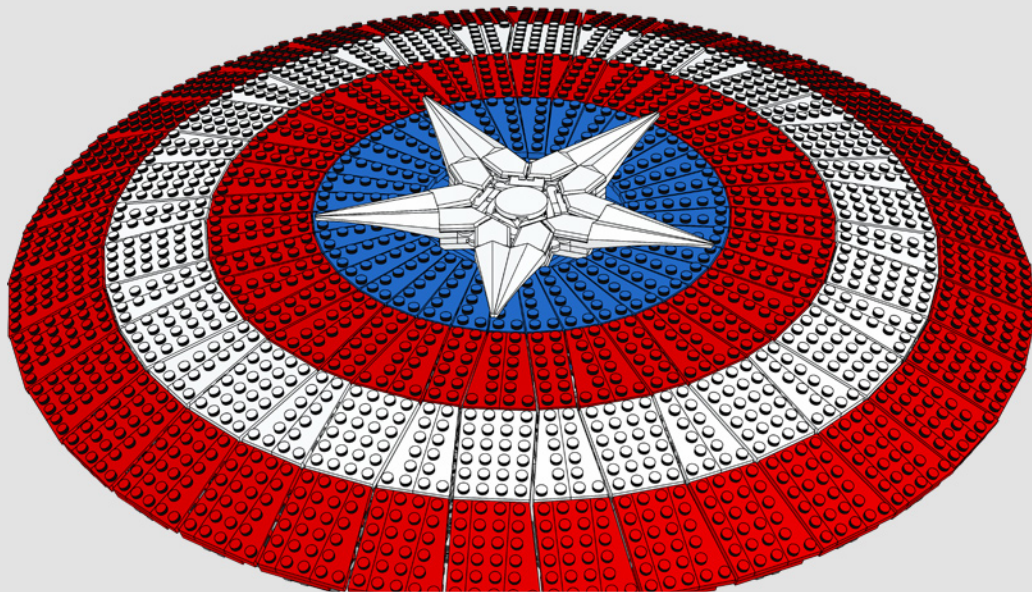
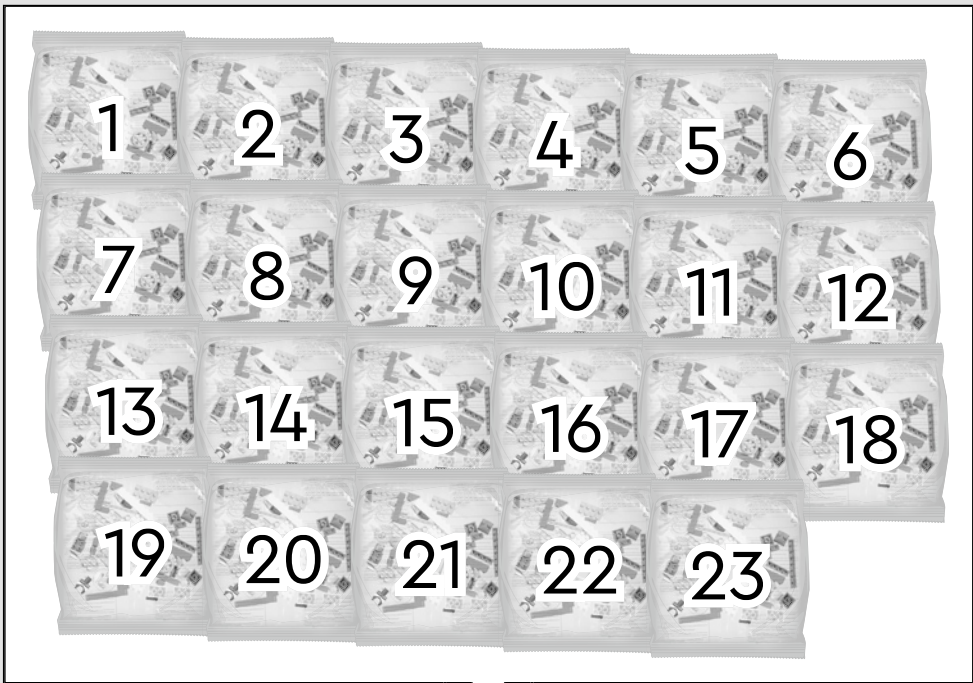

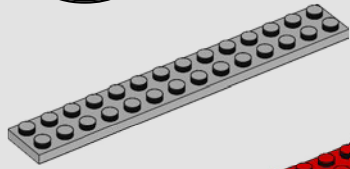
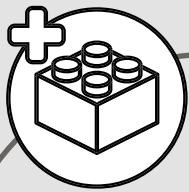

35x

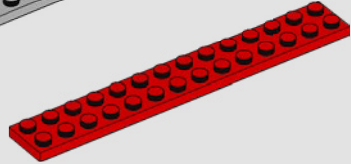

1x

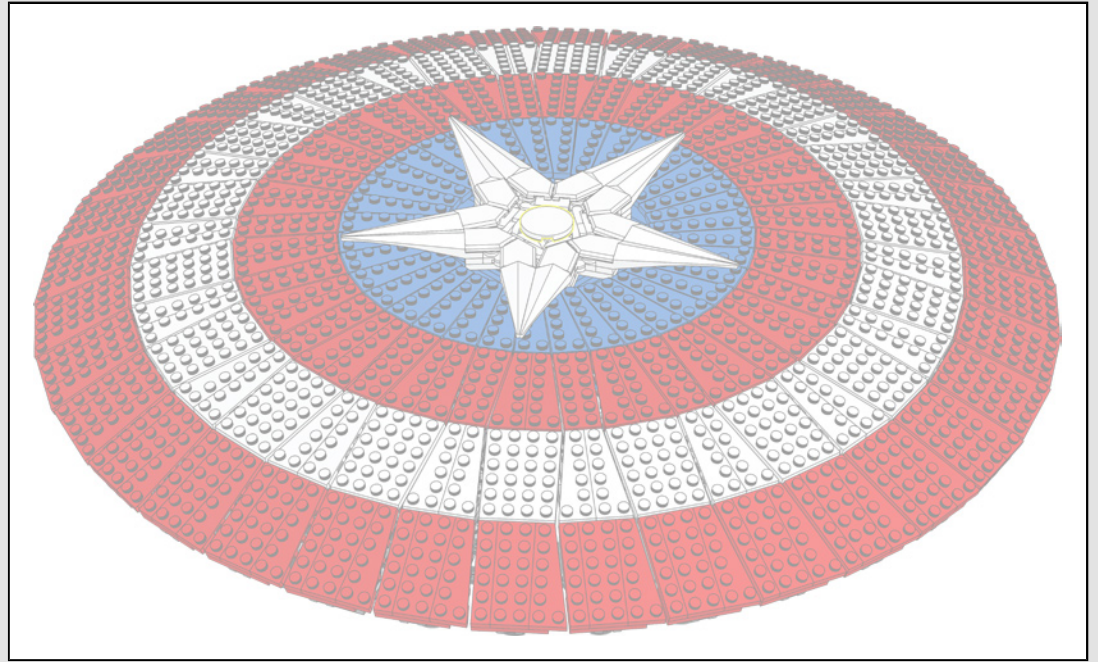
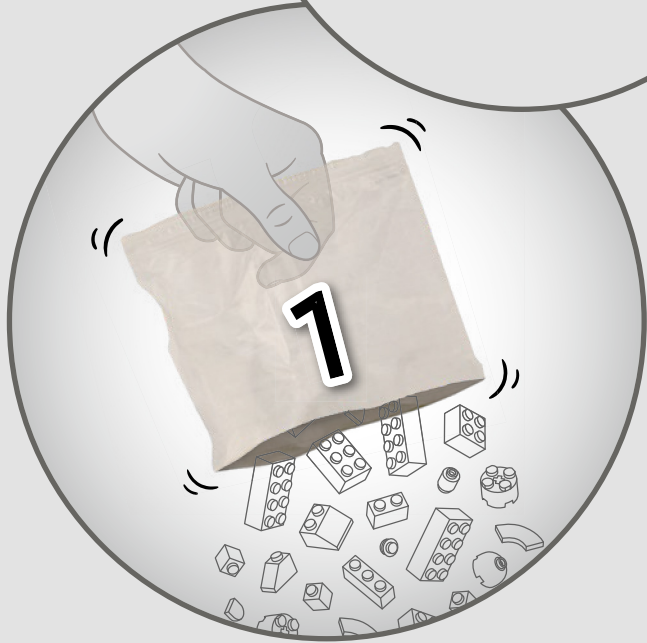

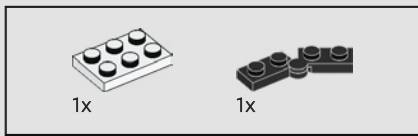

1

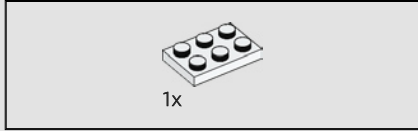
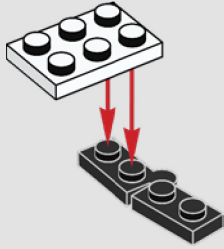

2

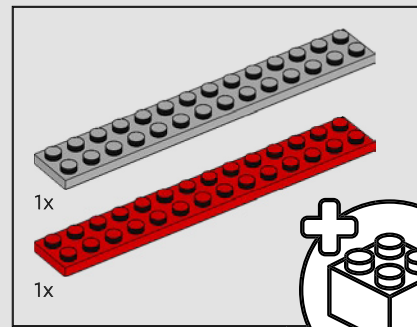
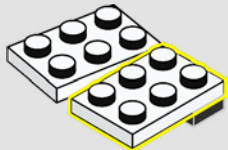

3

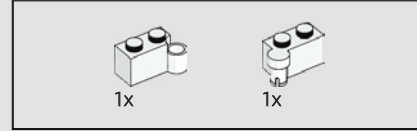
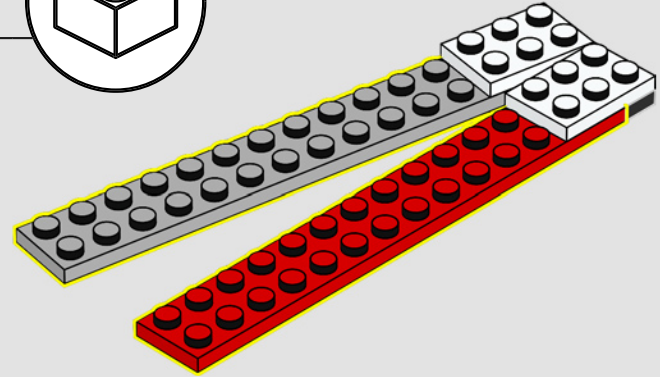
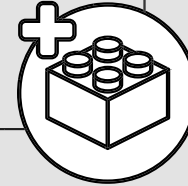

4

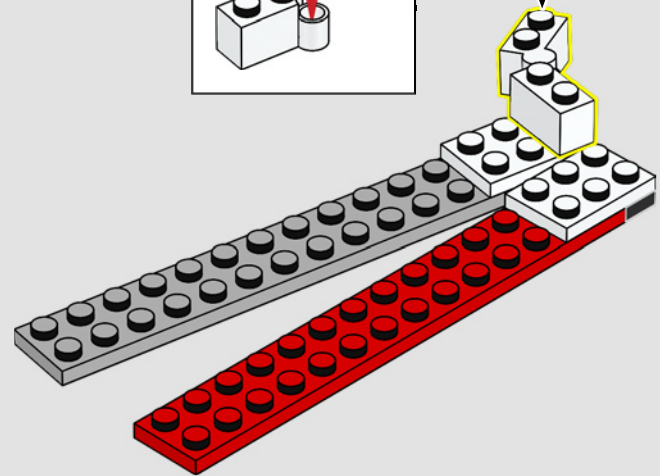
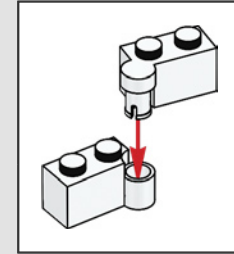

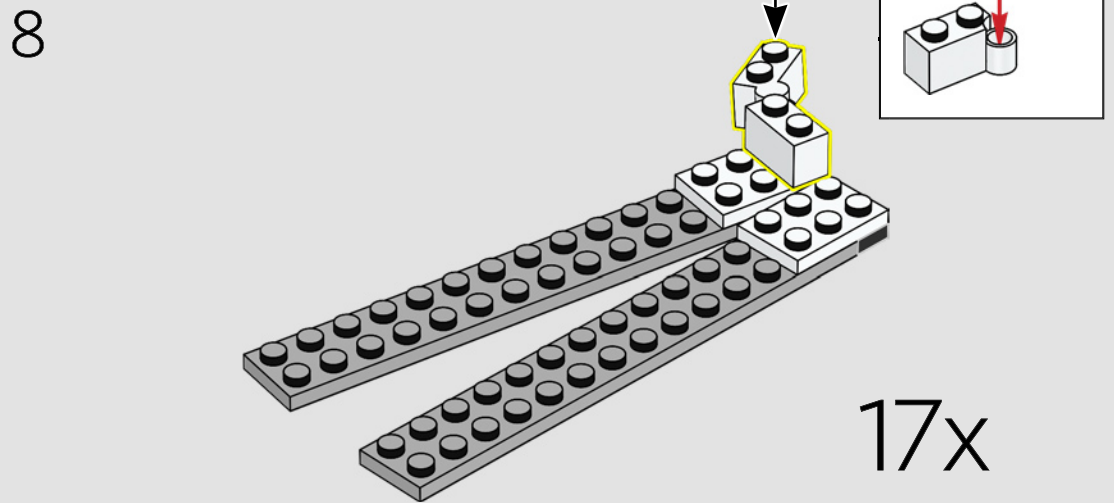
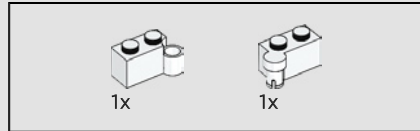
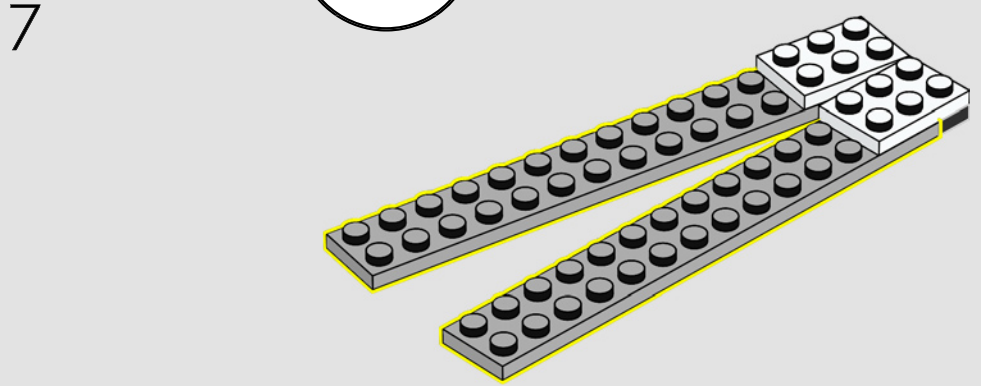
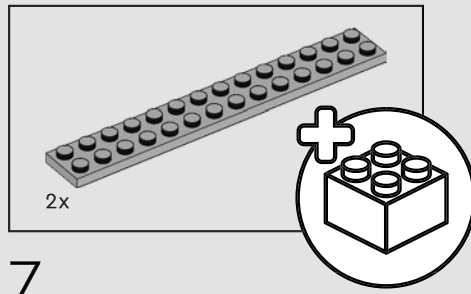
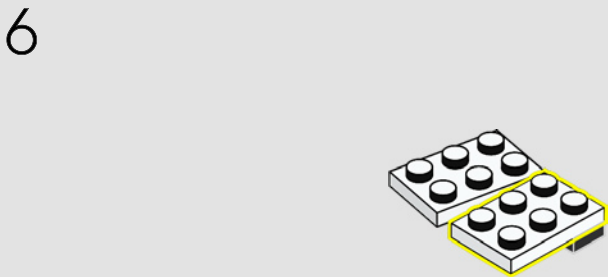
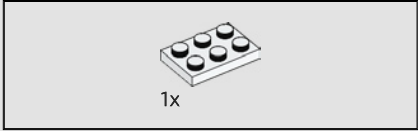
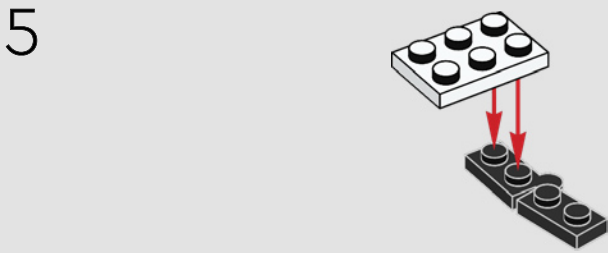
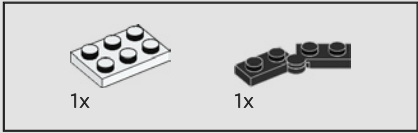
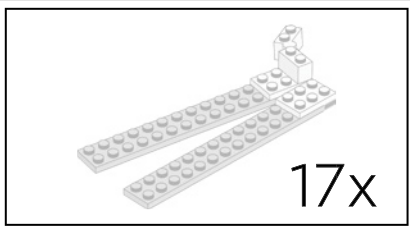

17x



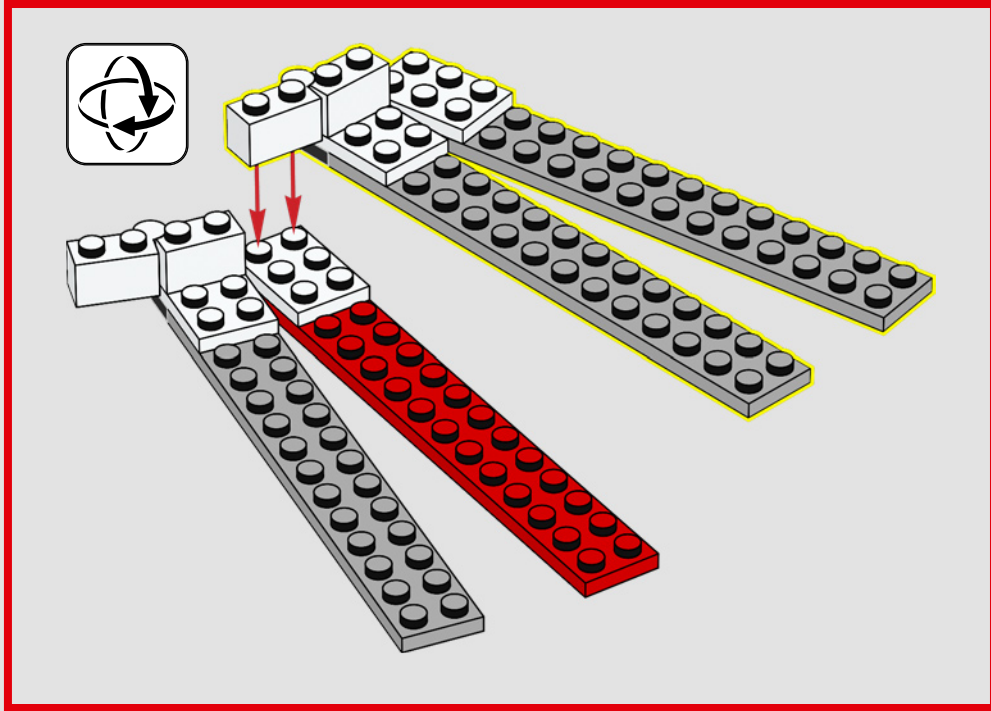

9

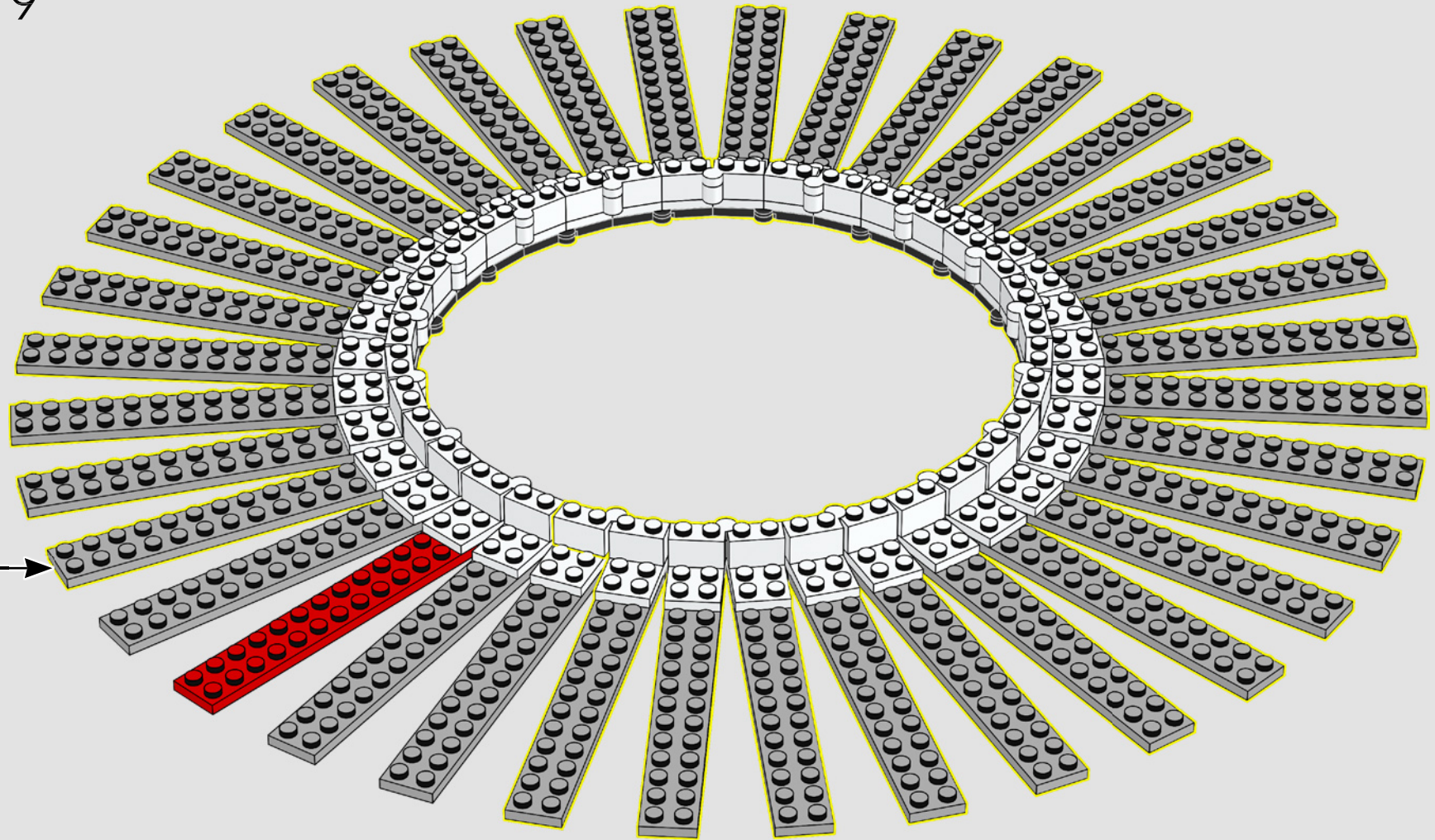

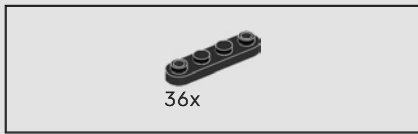

10

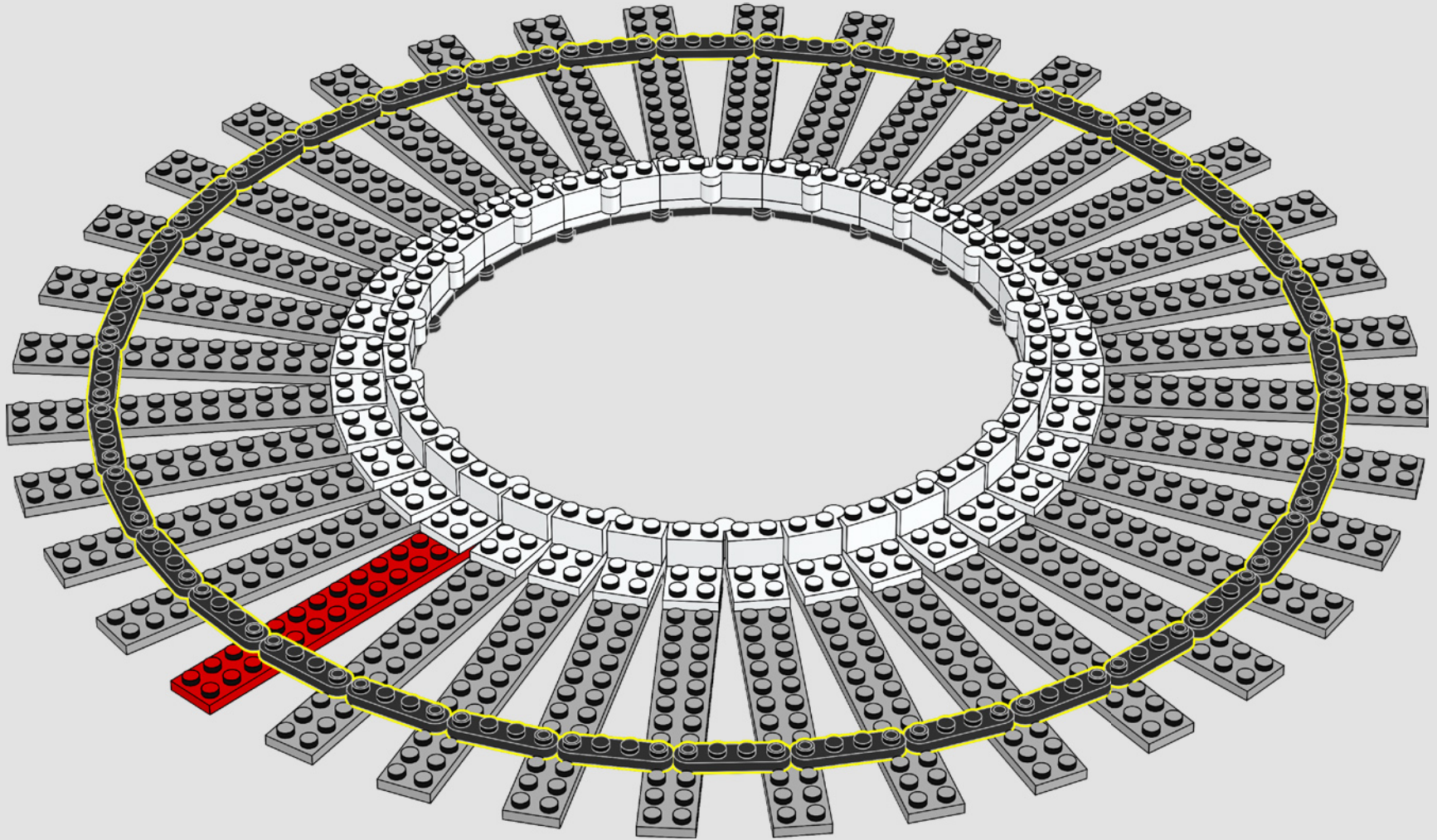

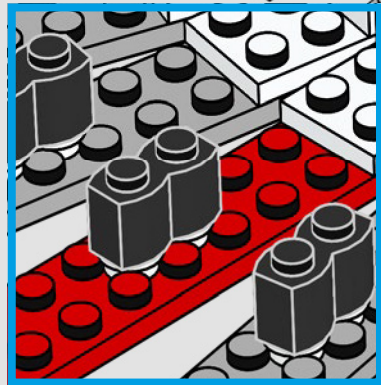
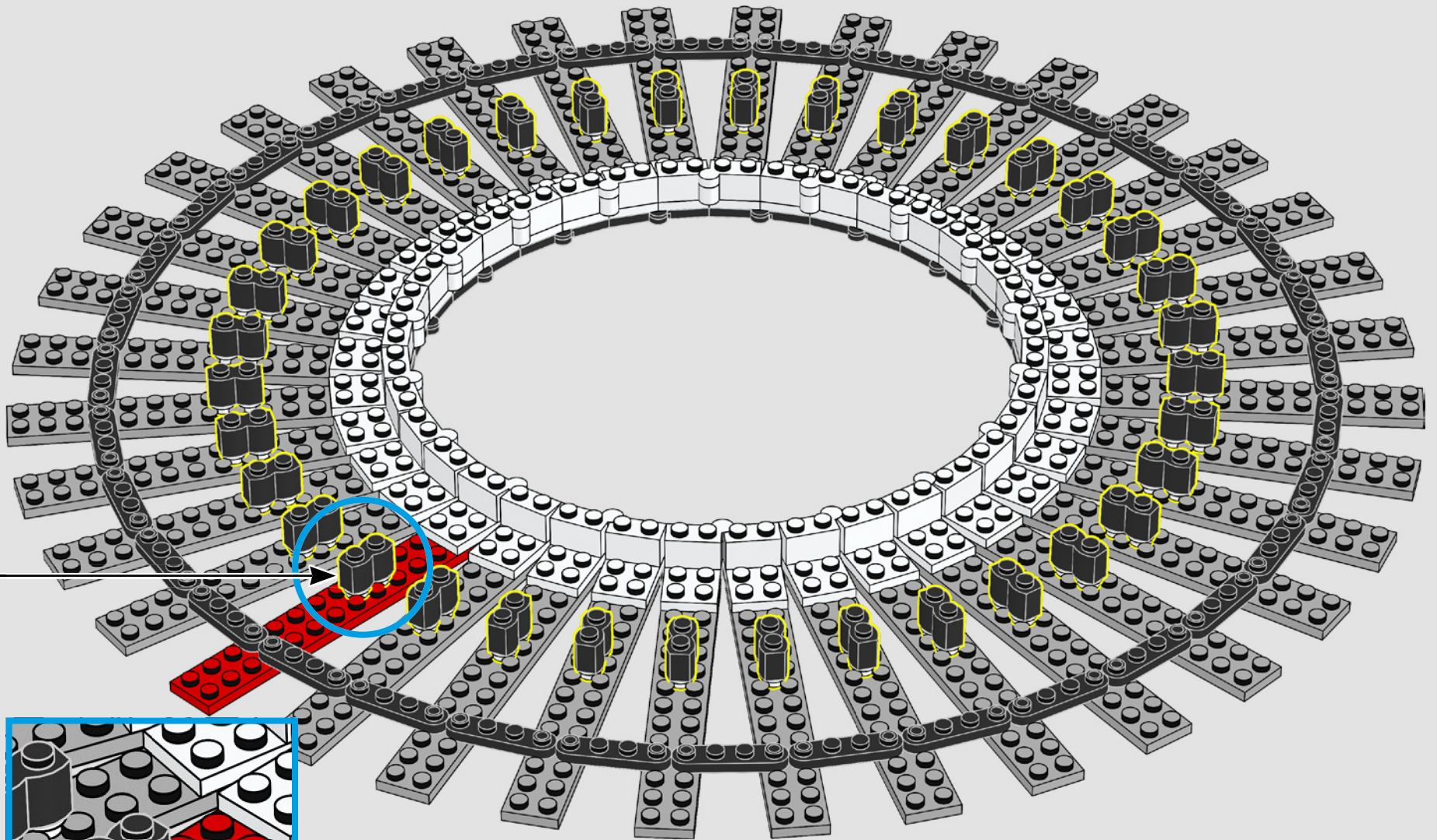







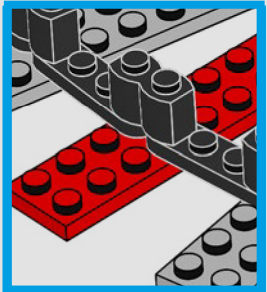
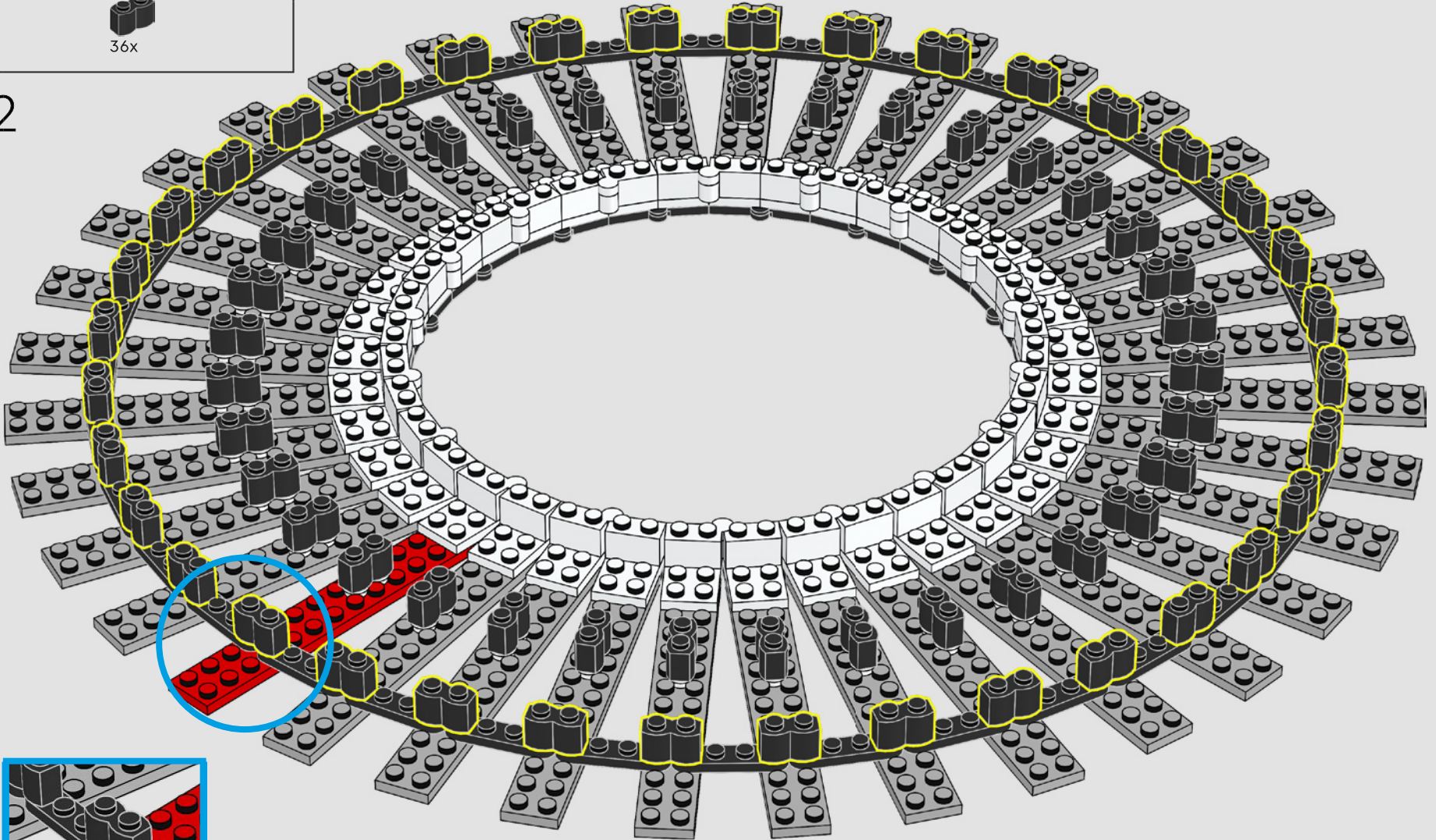

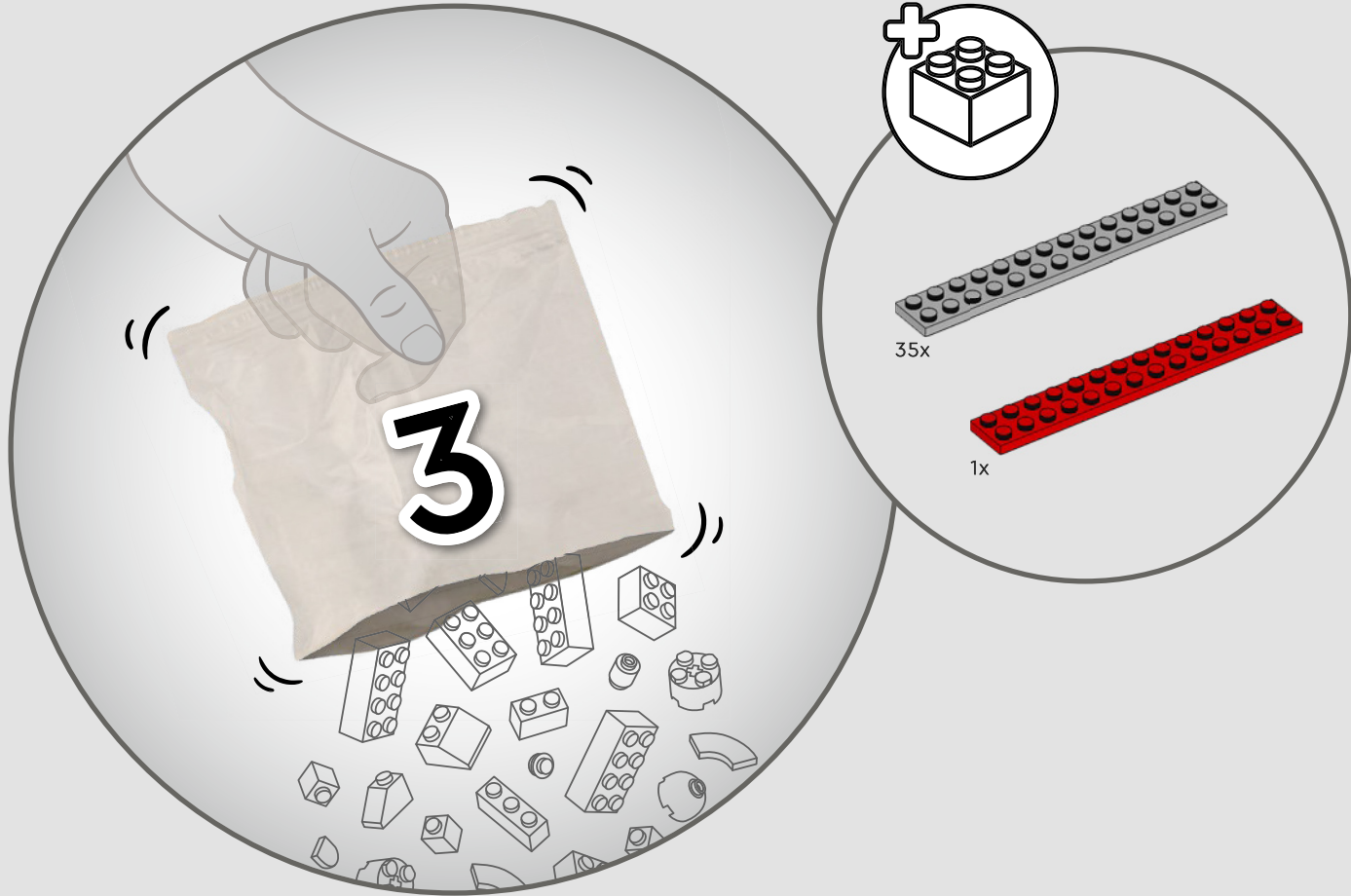
36x

12





 36x

 36x  36x  72x
 36x  36x

13

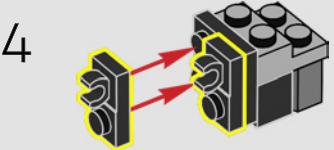
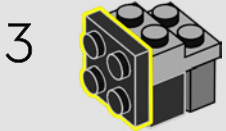
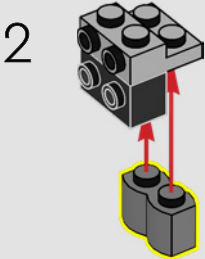
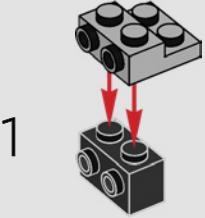

36x



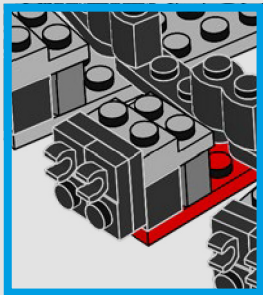
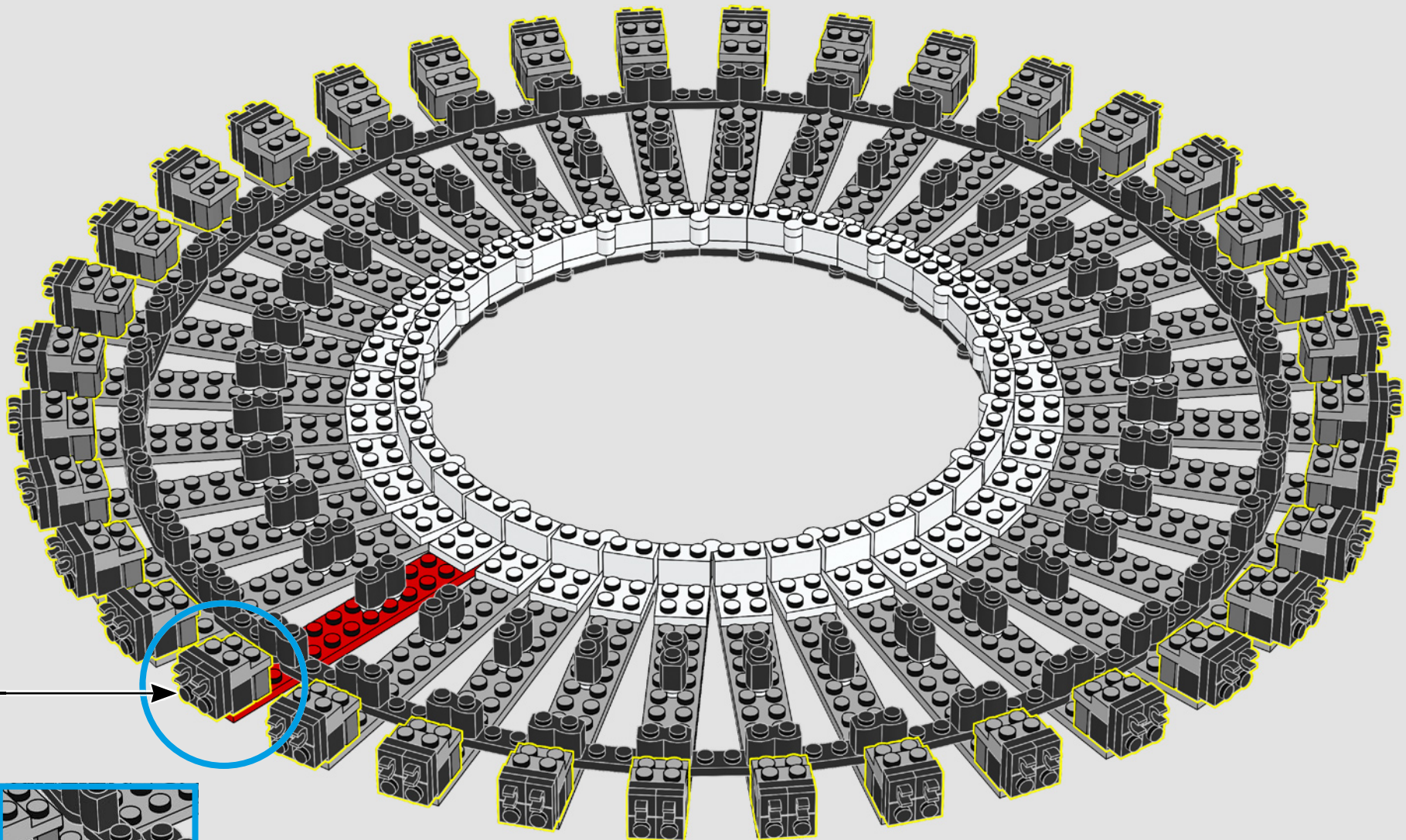

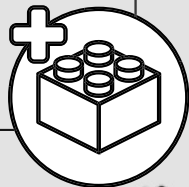
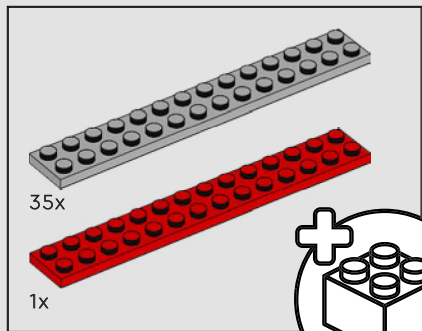

14

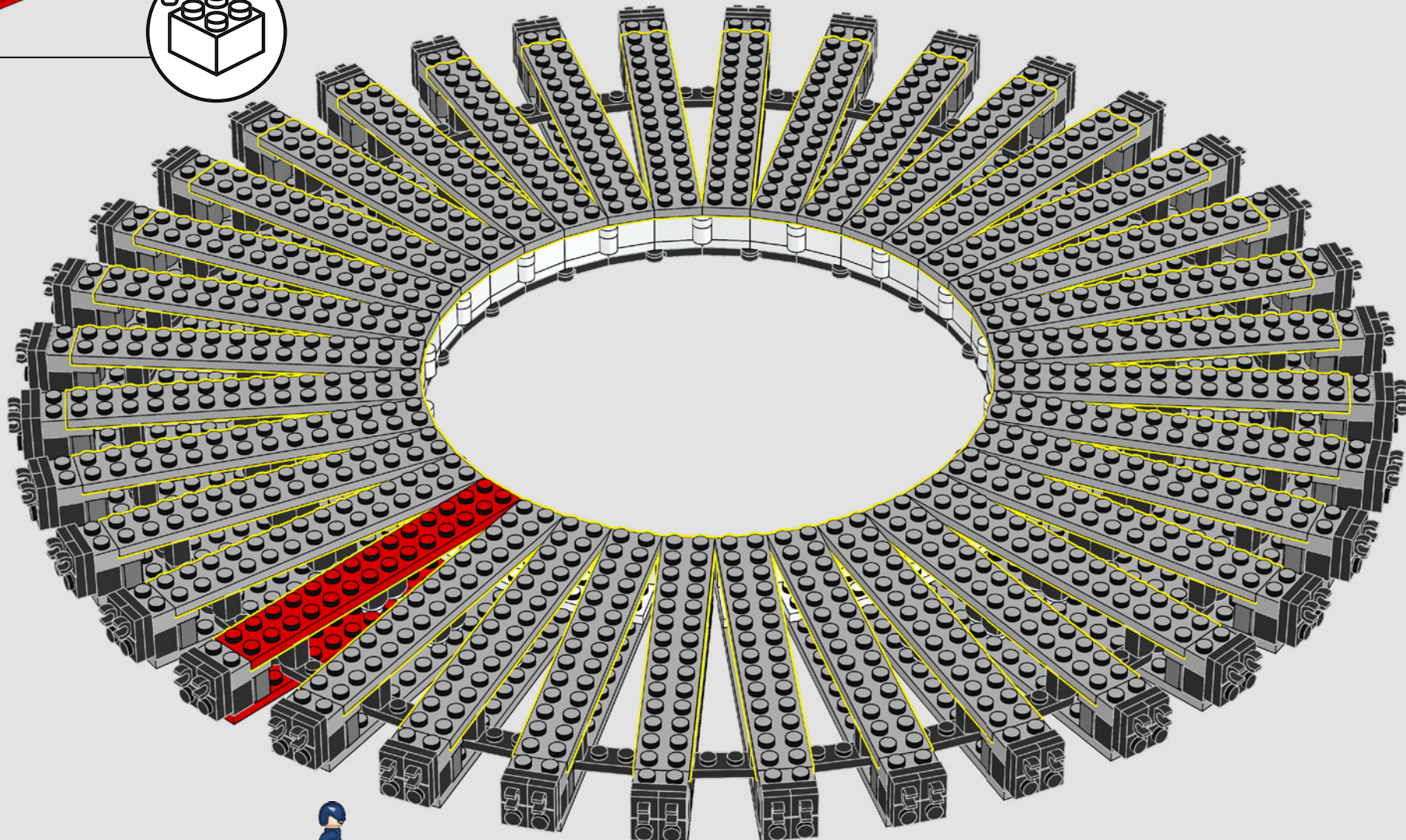



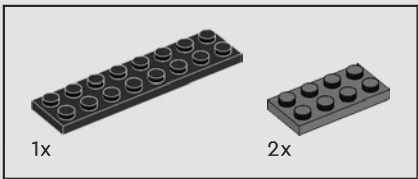

15

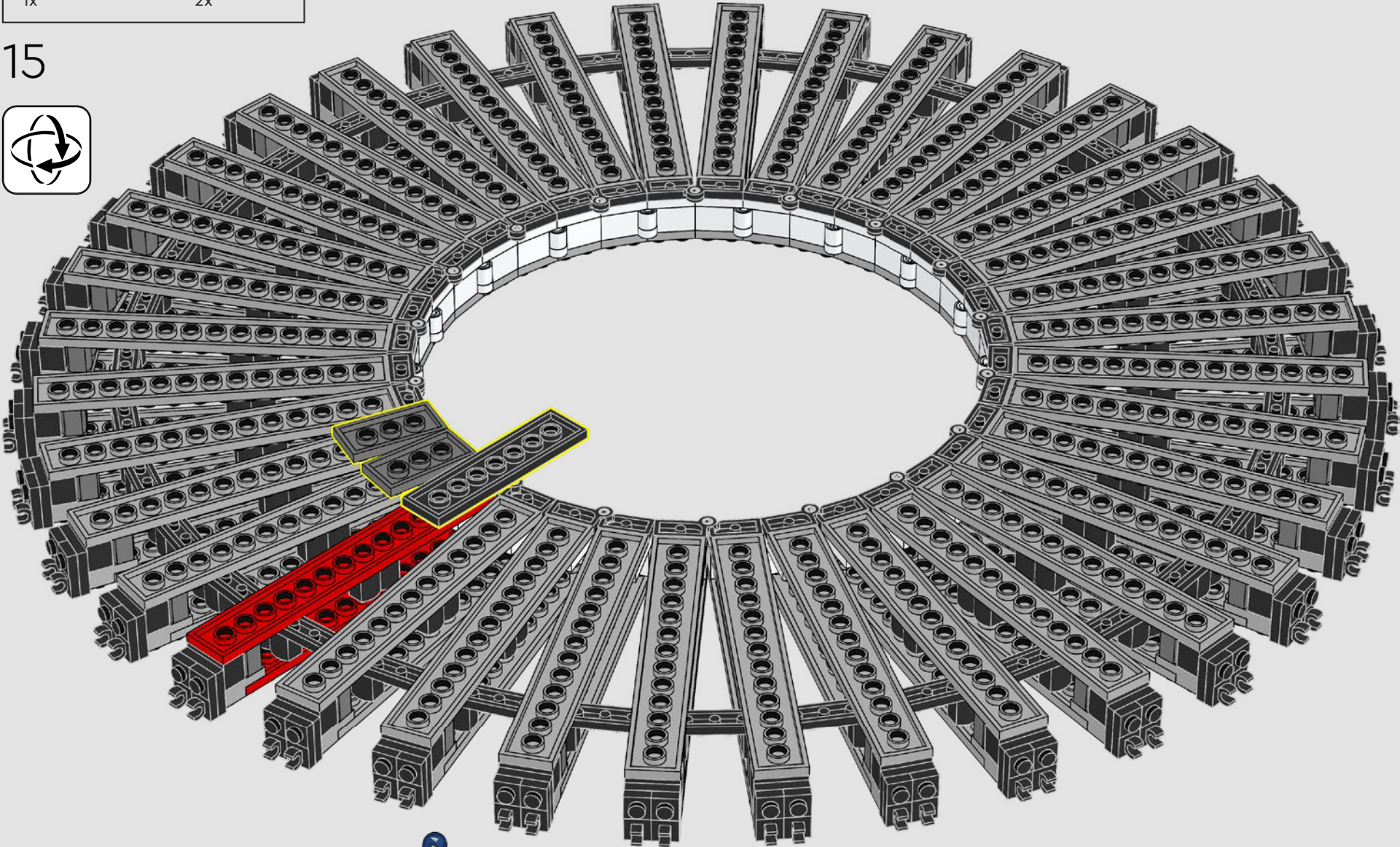

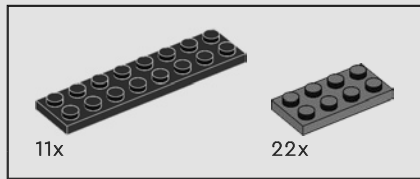

16

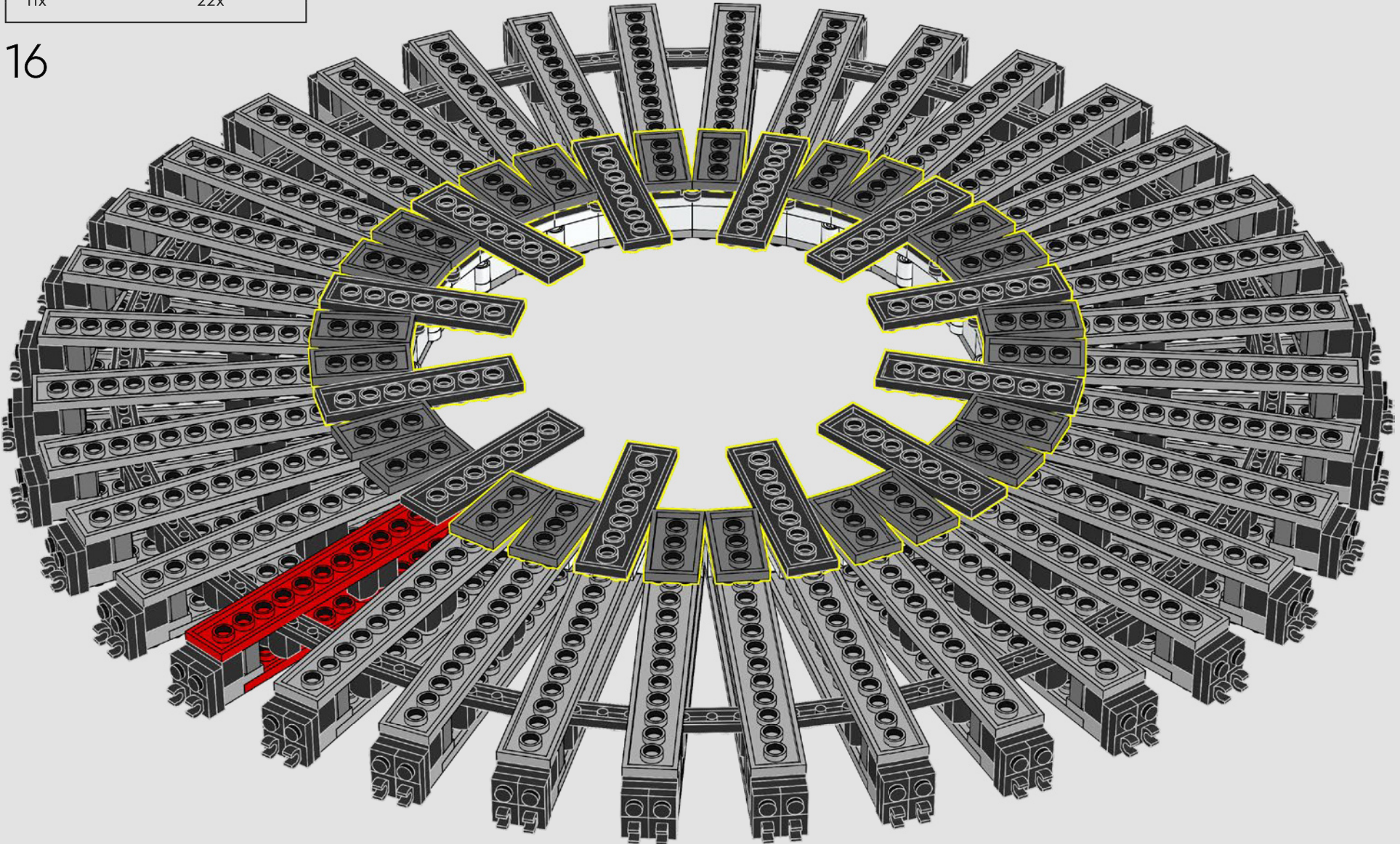

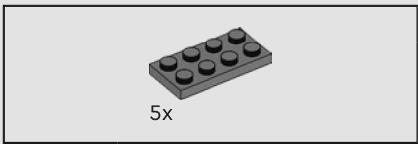

17

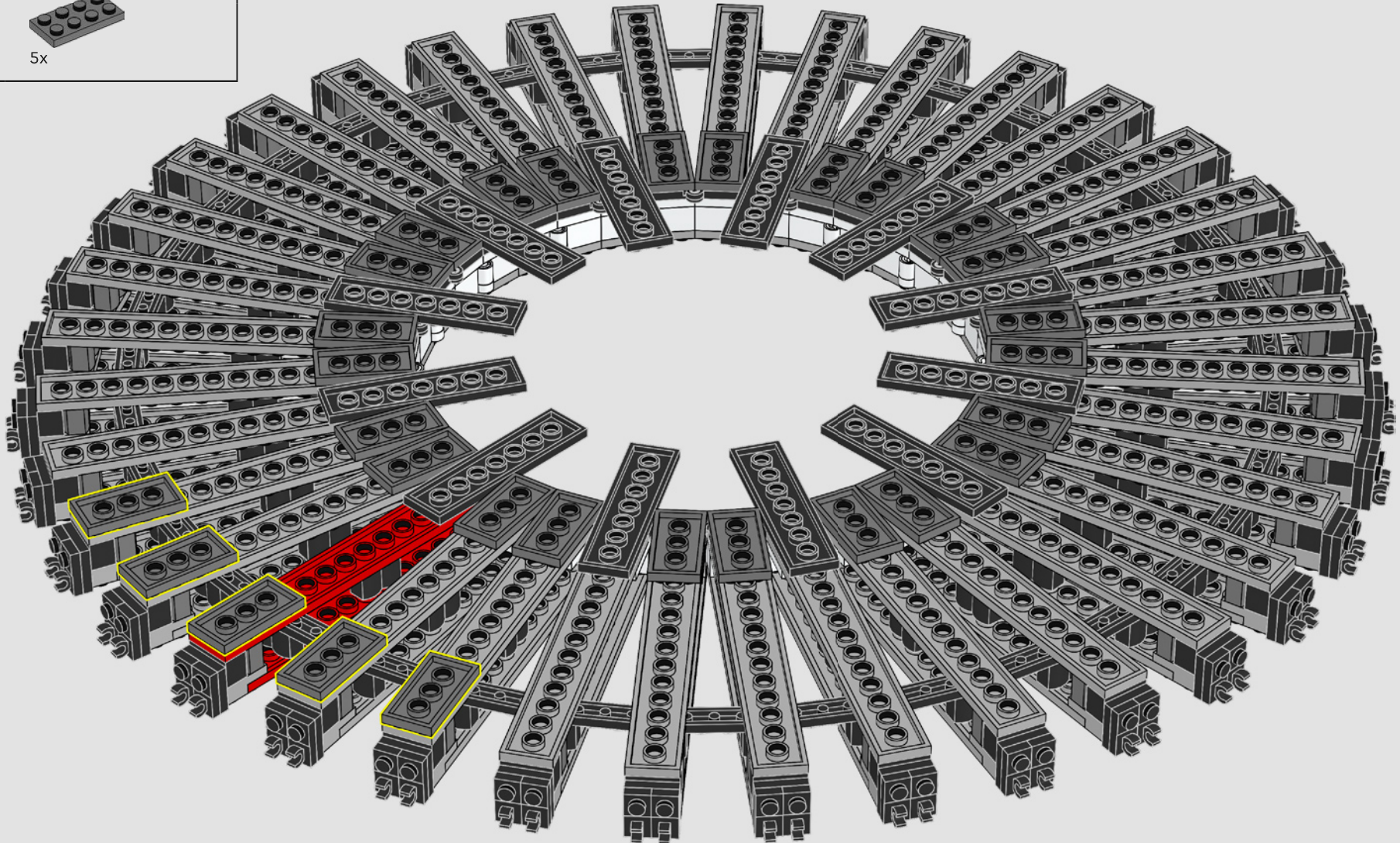

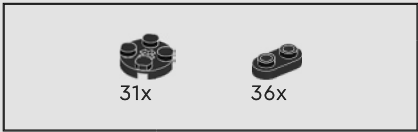

18

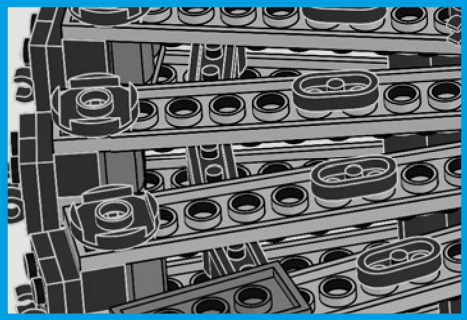
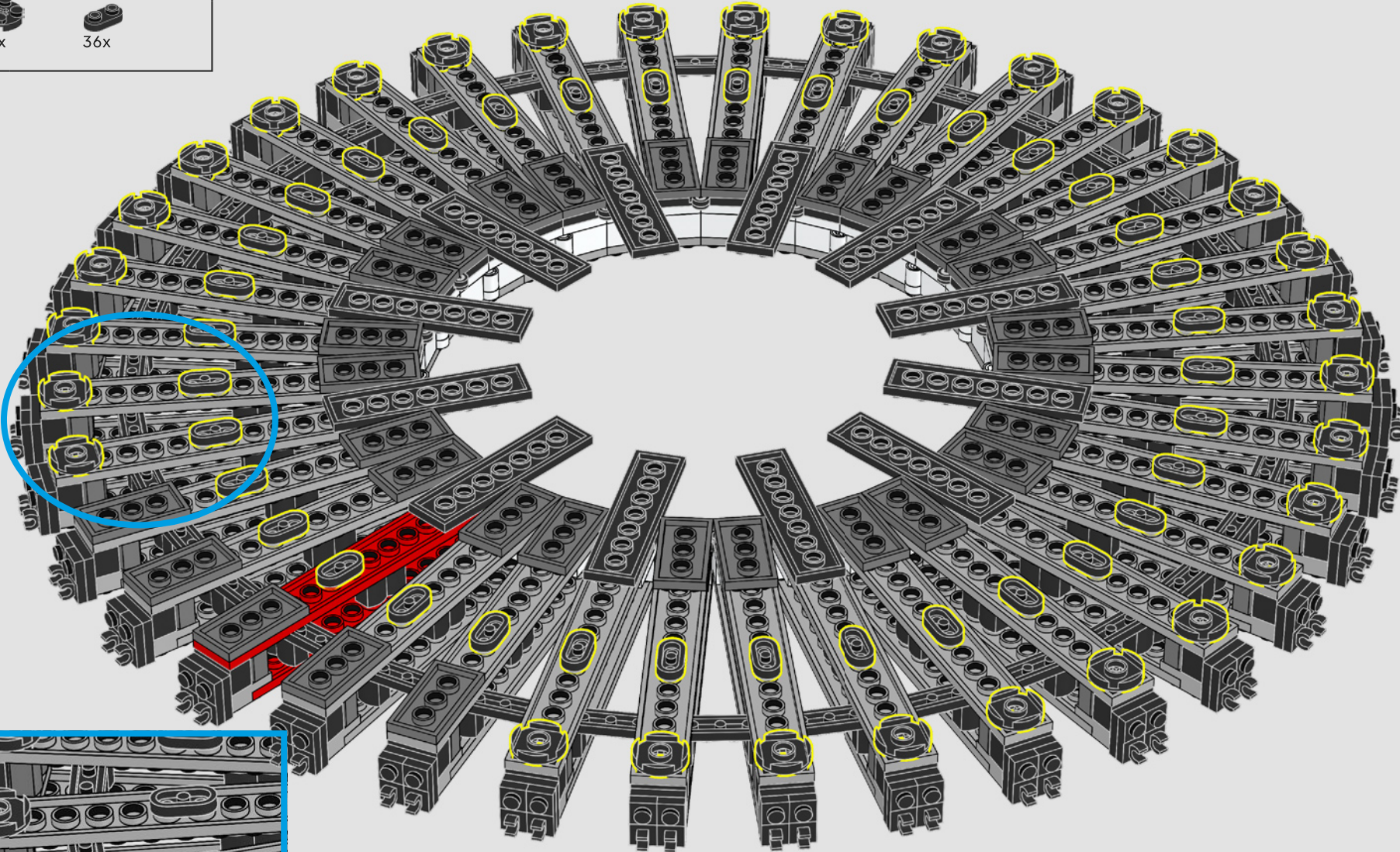



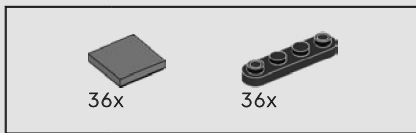

19

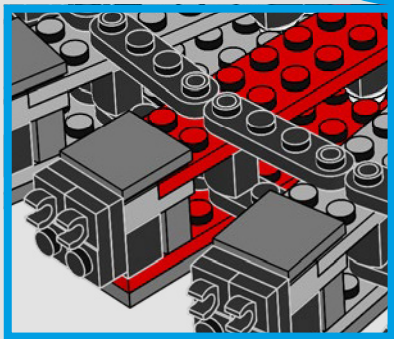
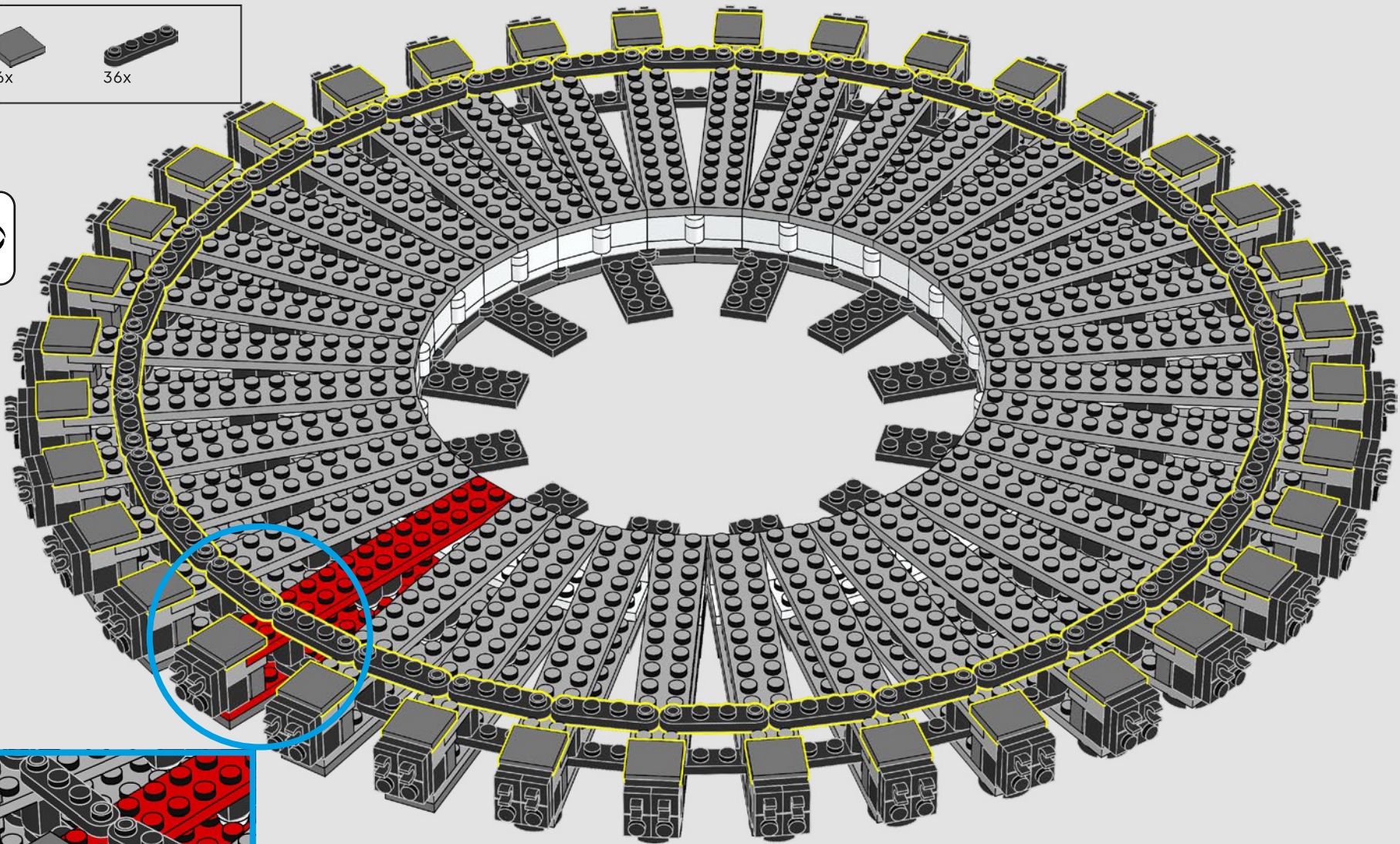



20

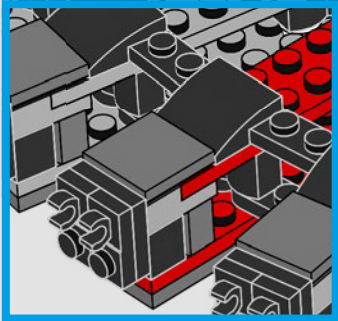
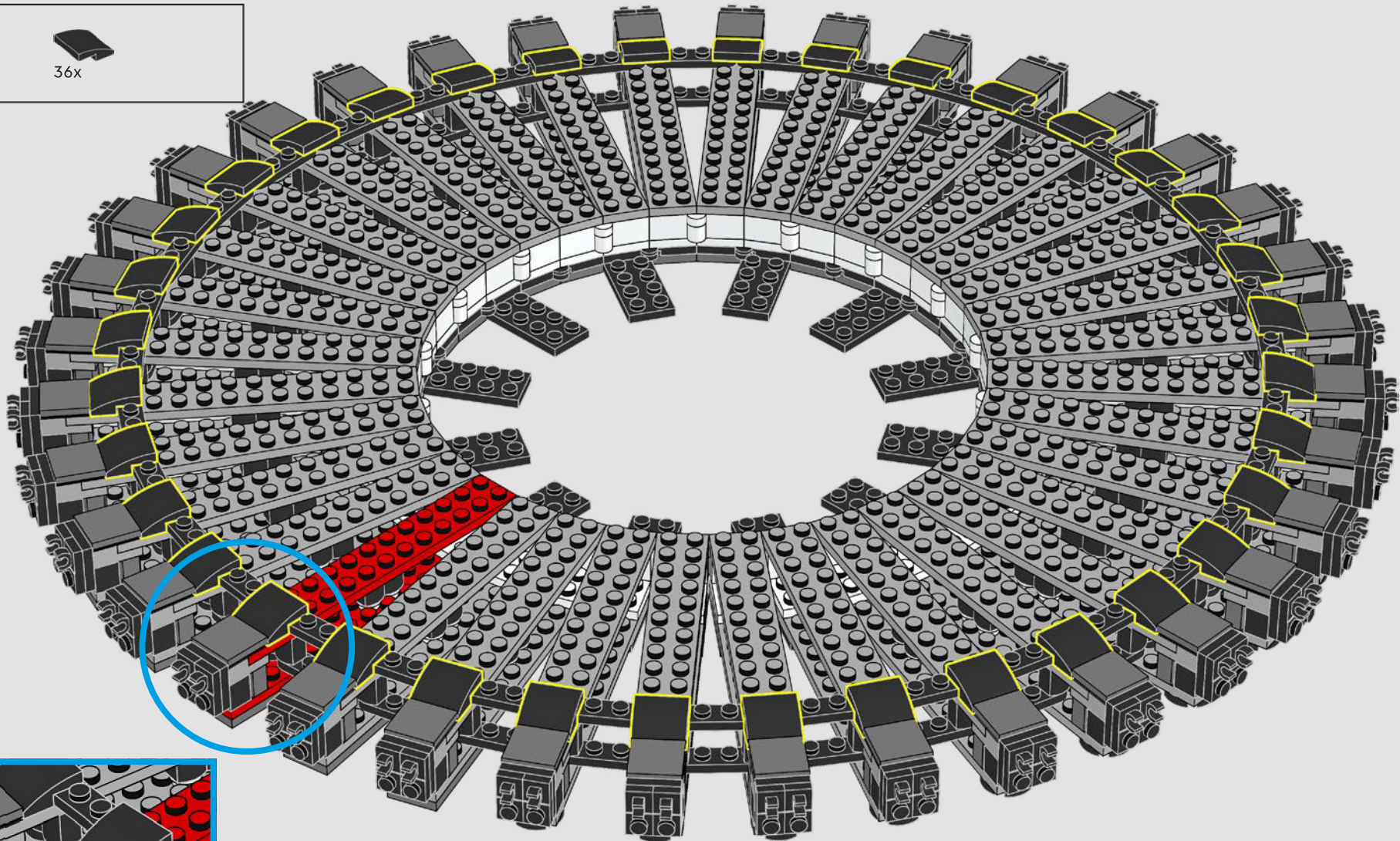

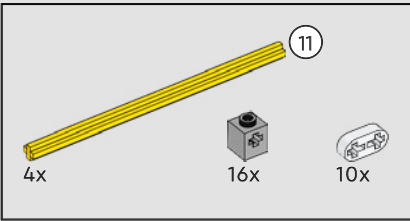
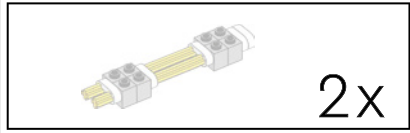
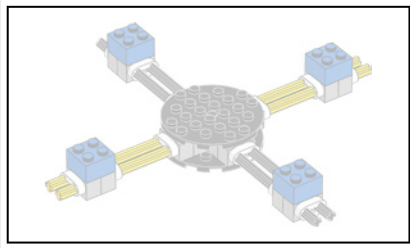

21

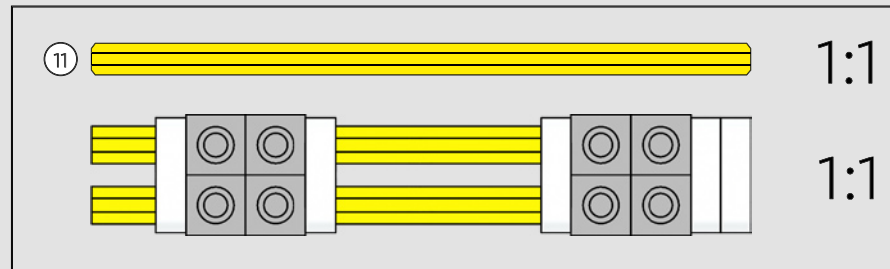
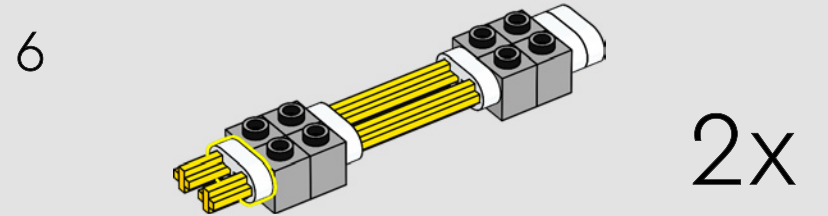
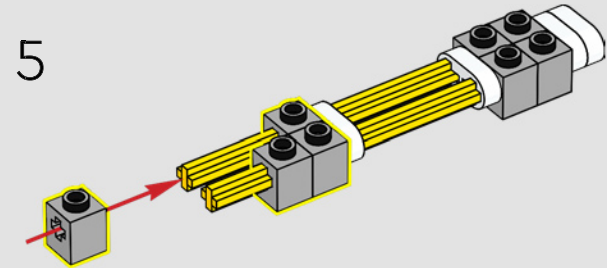
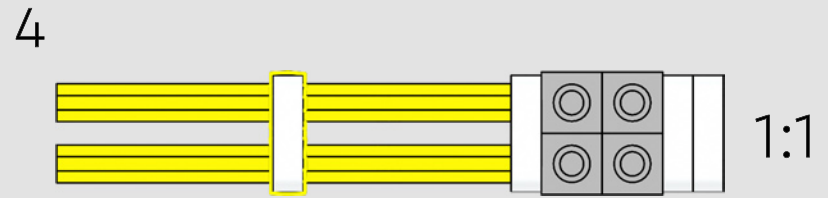
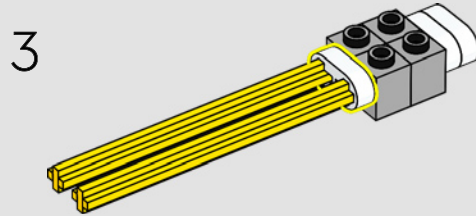
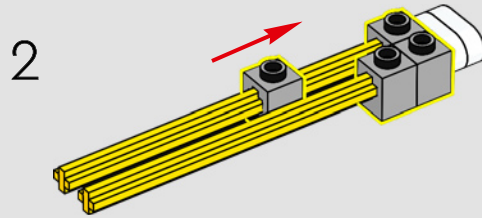
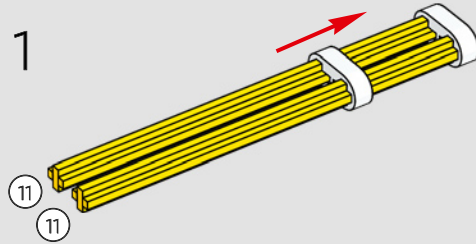

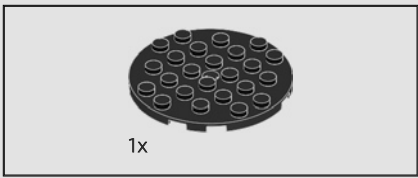

22

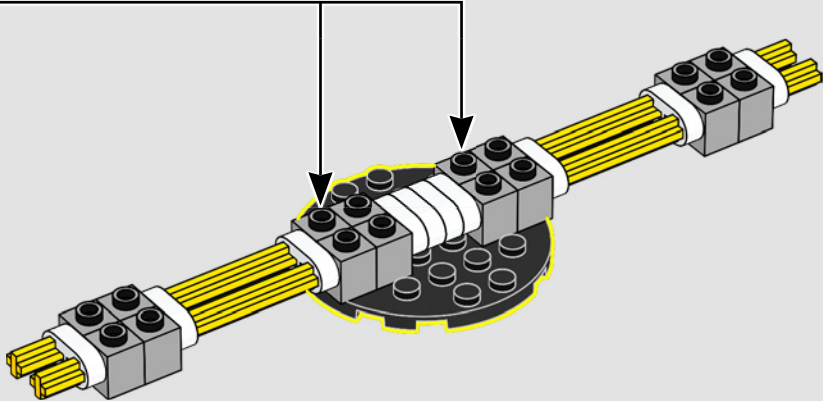

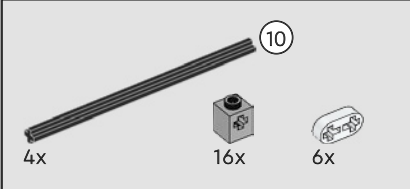
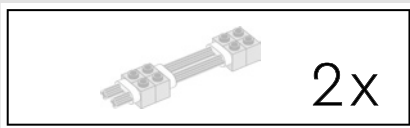

23

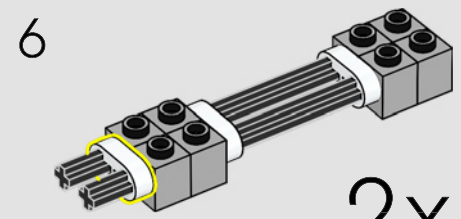
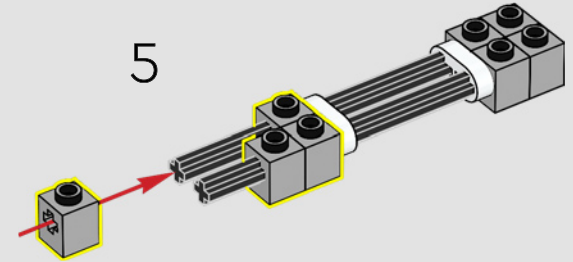
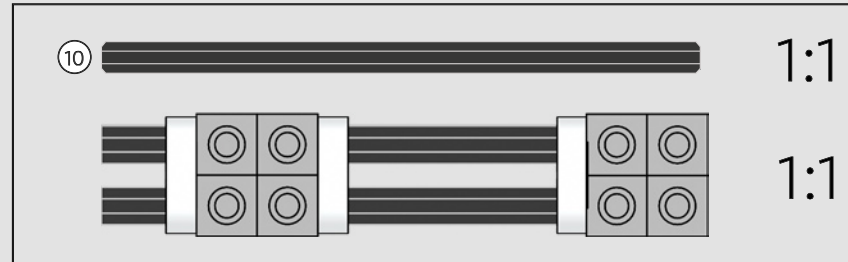
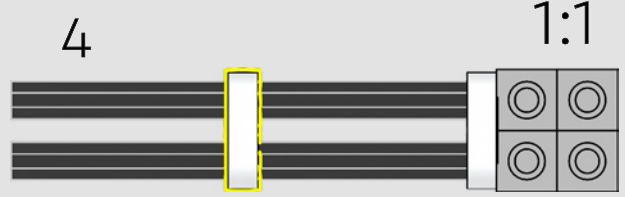
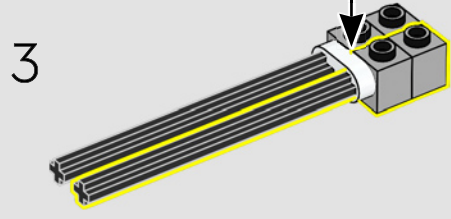
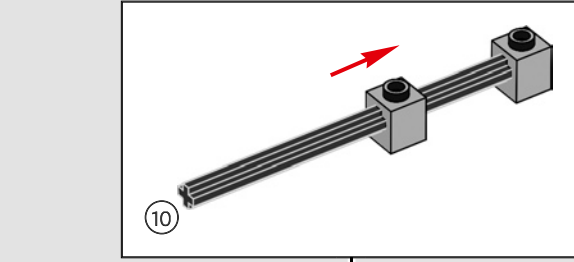
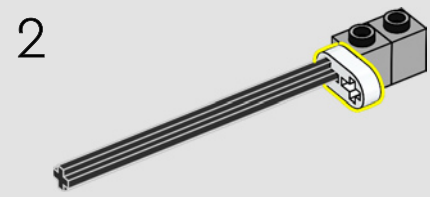
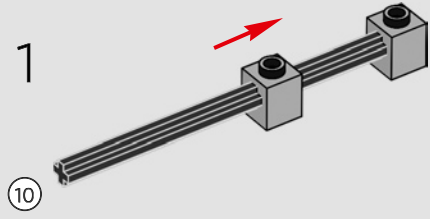

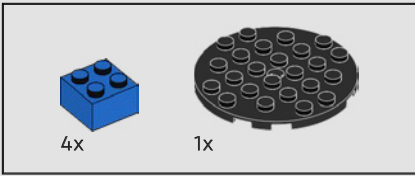

24

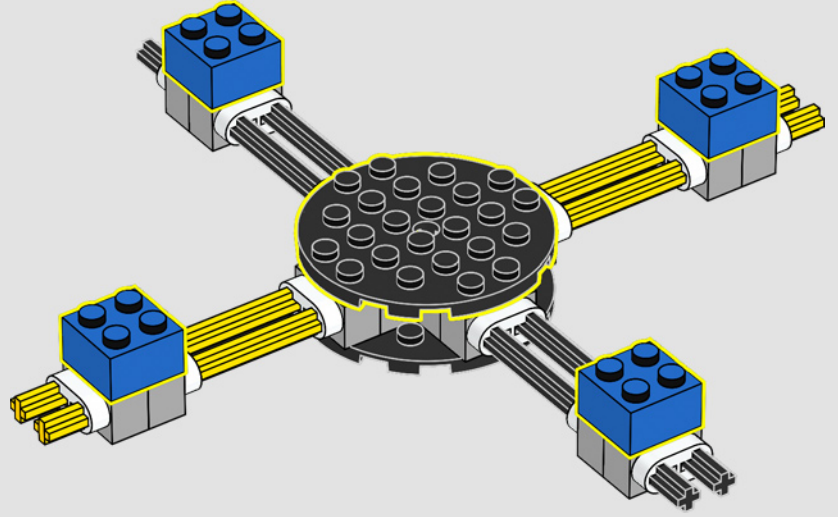
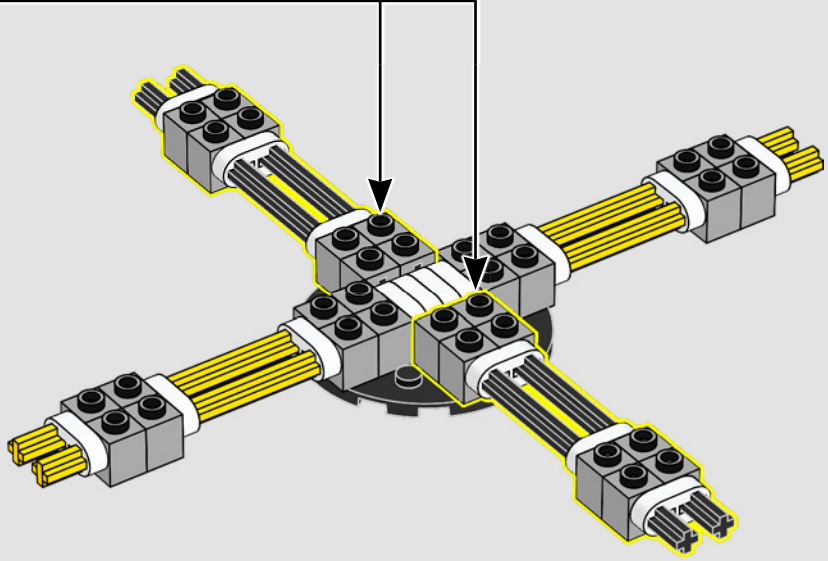

25

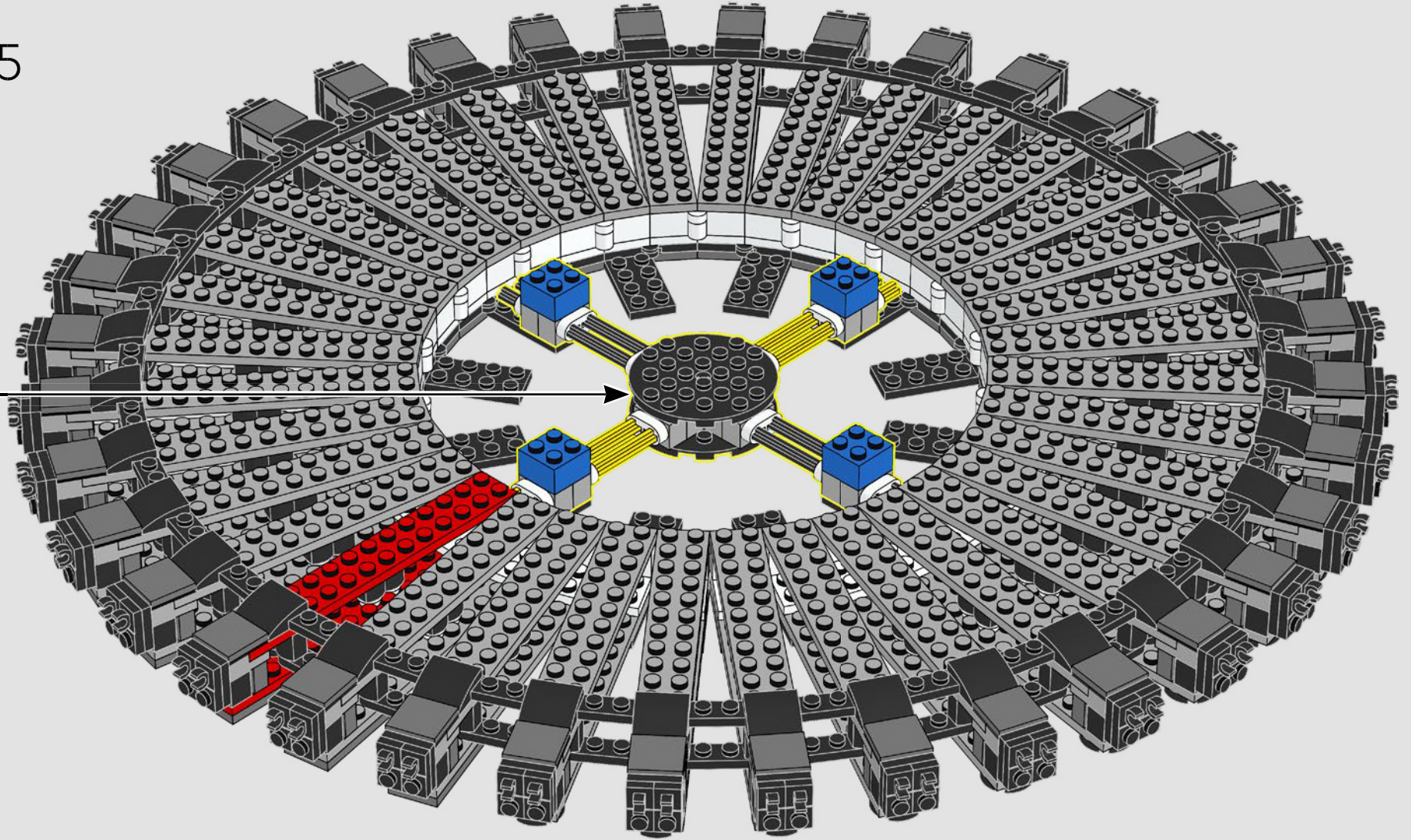

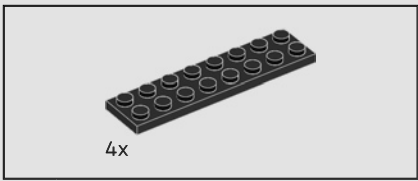

26

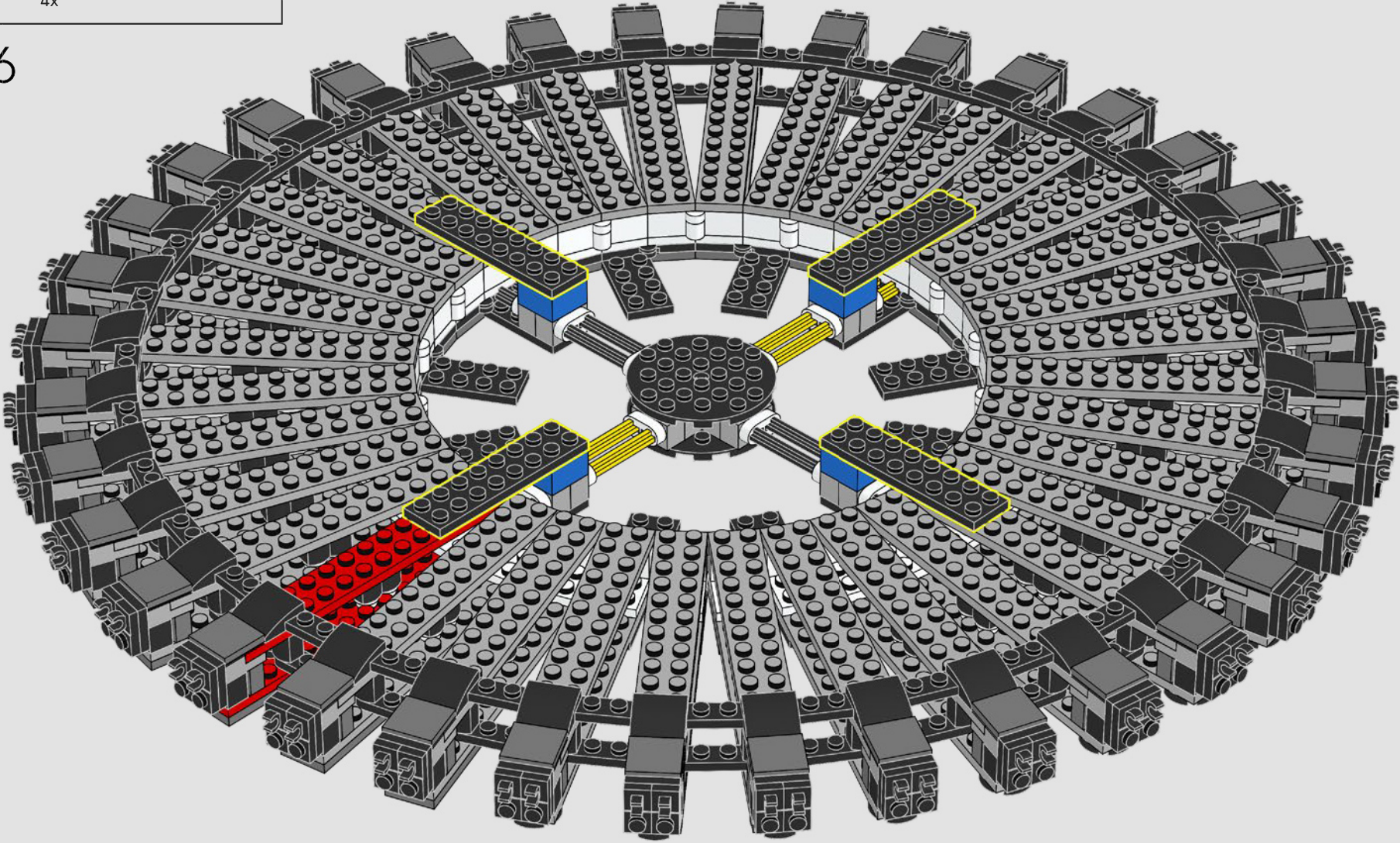



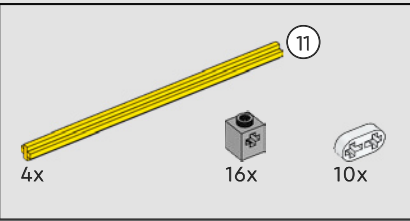
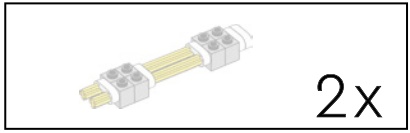
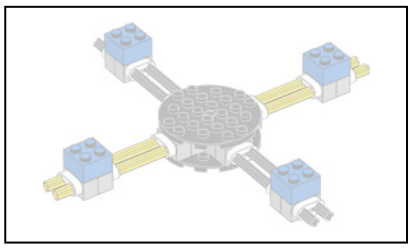

27

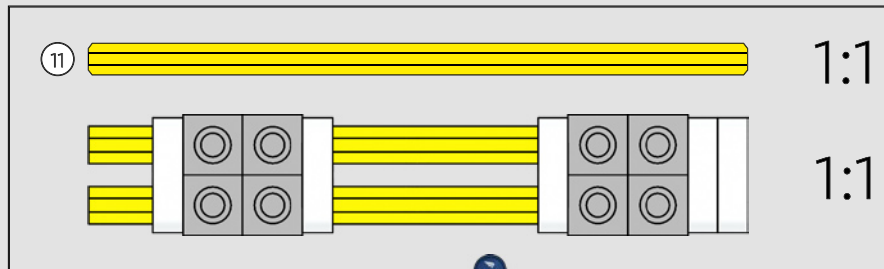
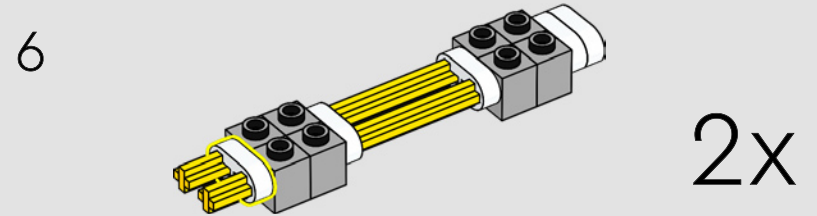
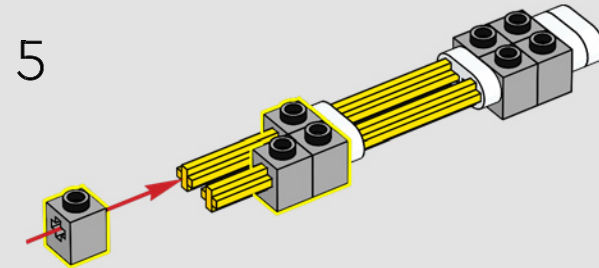
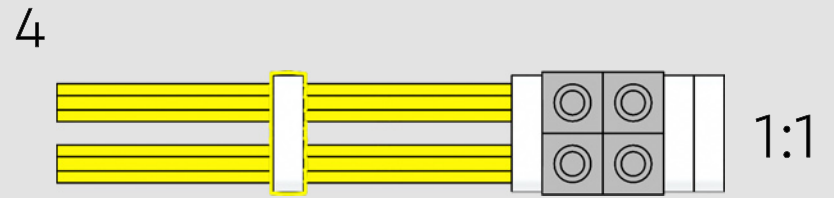
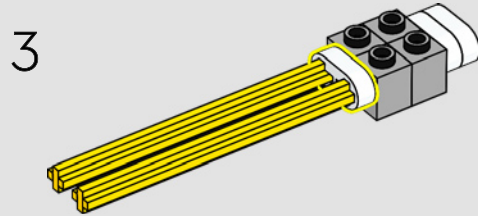
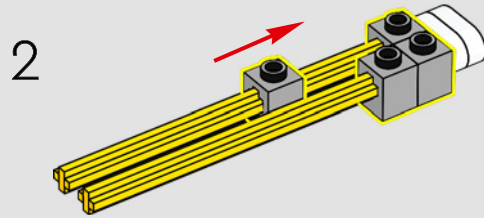
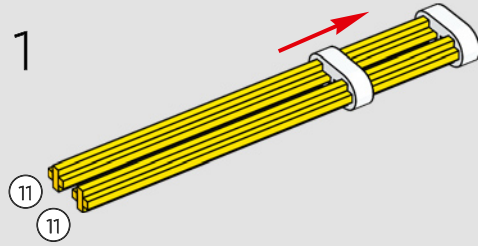

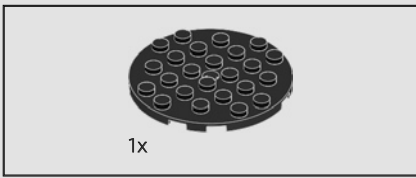

28

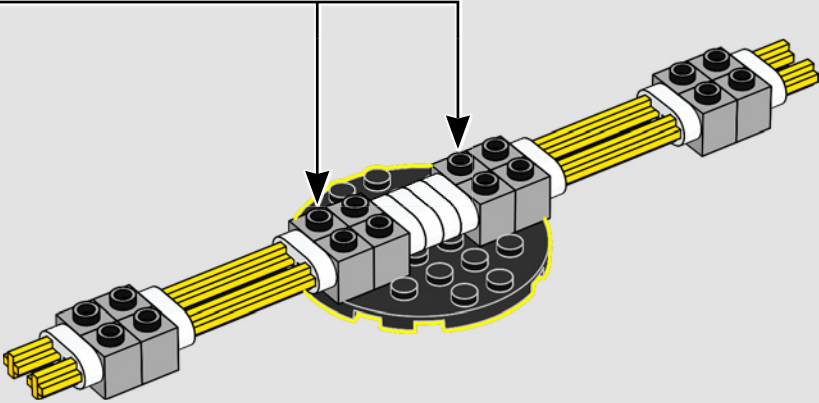

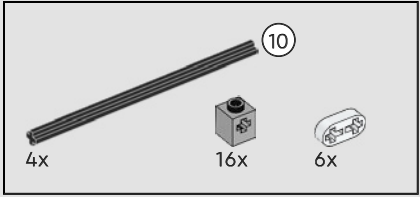
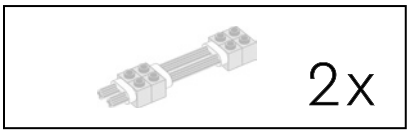

29

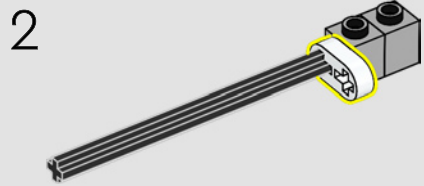
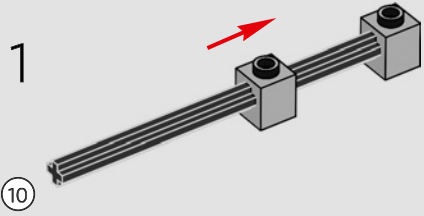

3

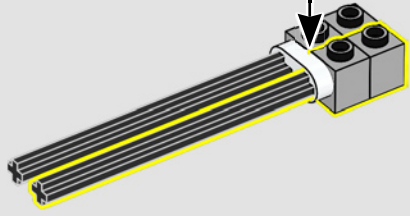

4

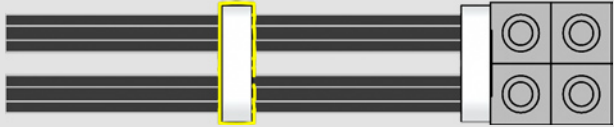

1:1

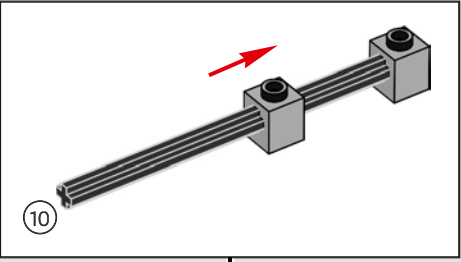
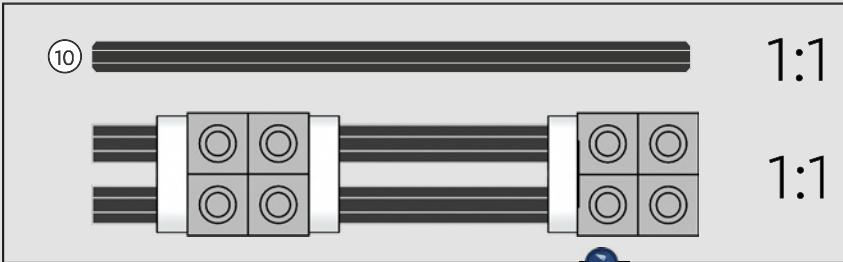

5

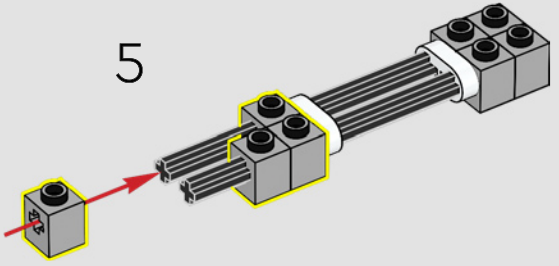

6

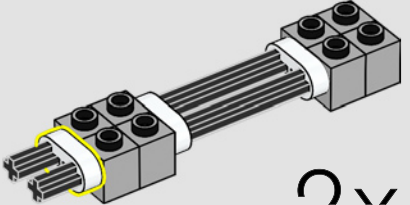

2x



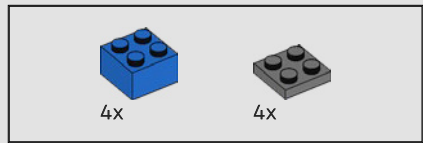
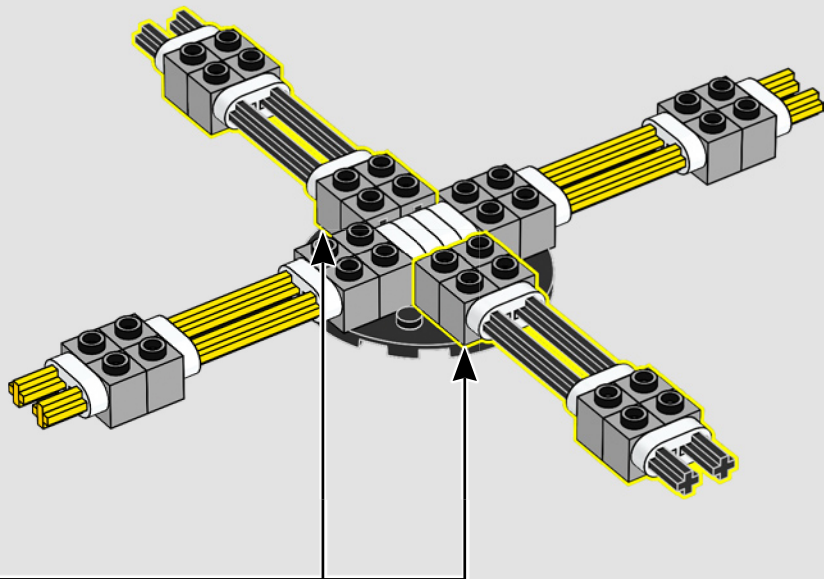

30

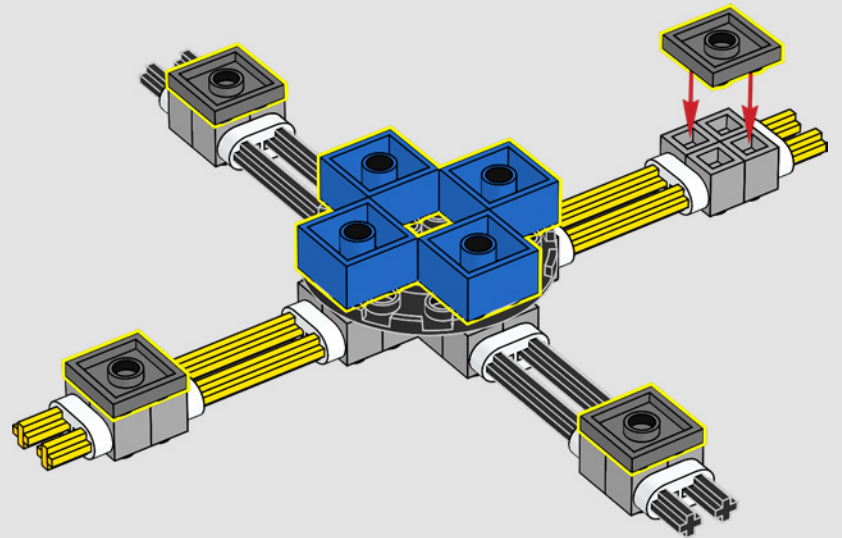
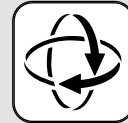

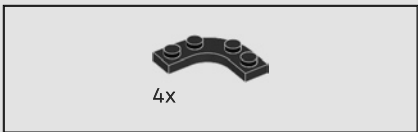

31

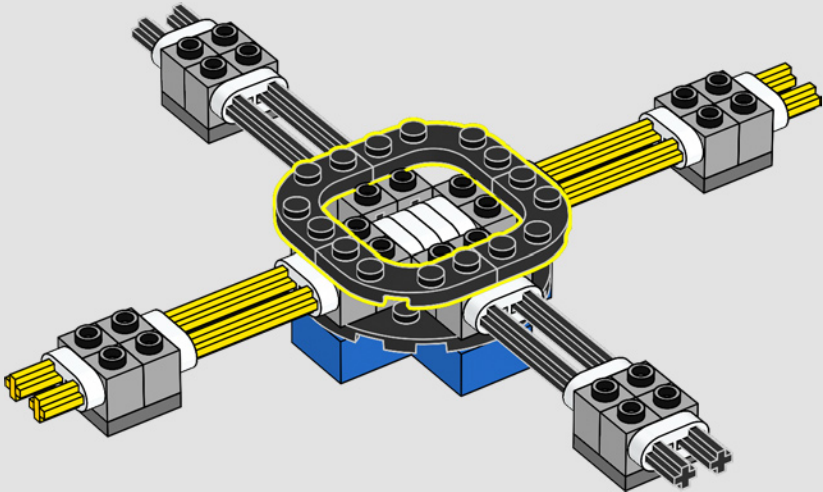

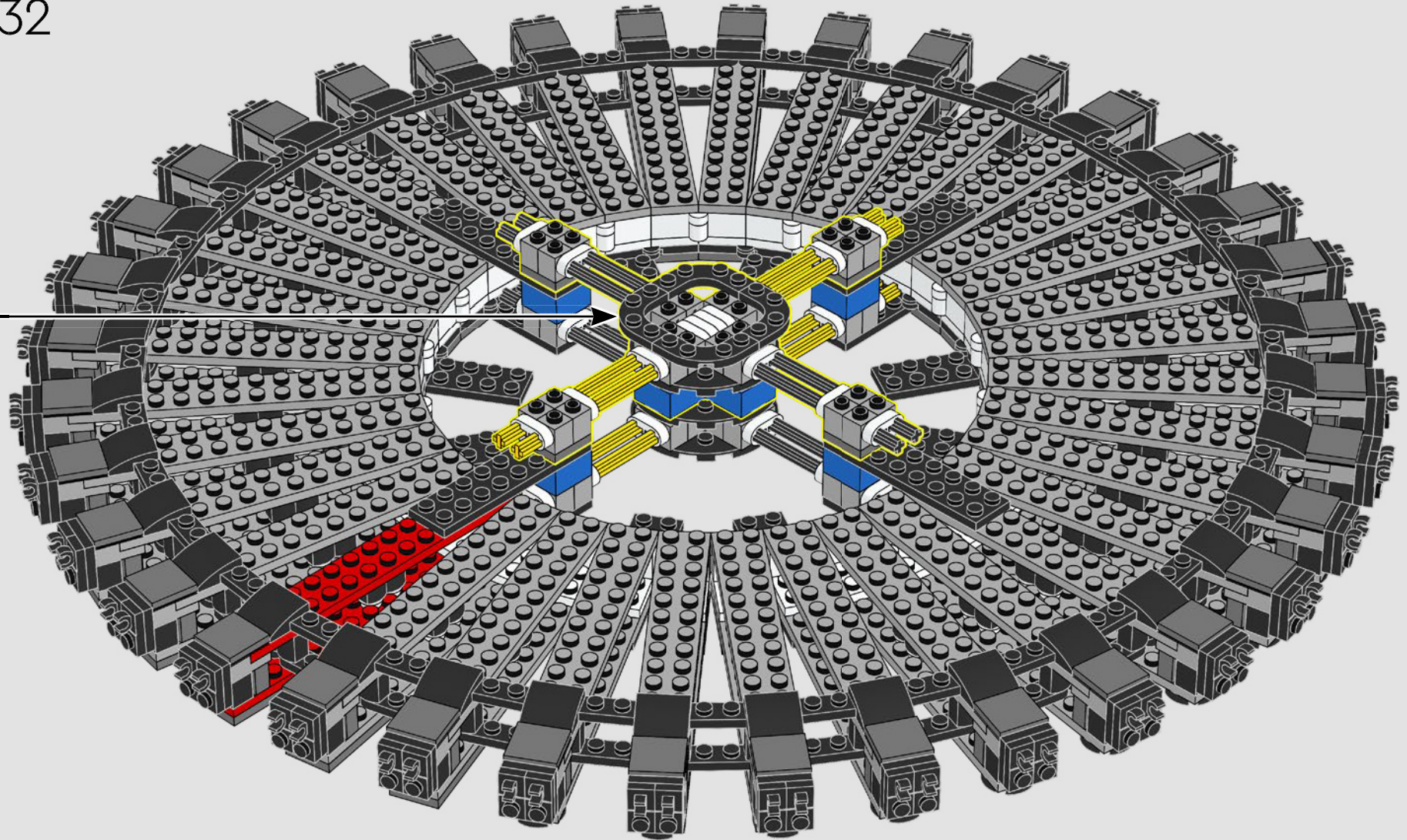

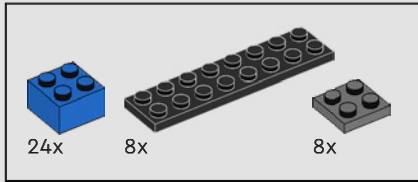
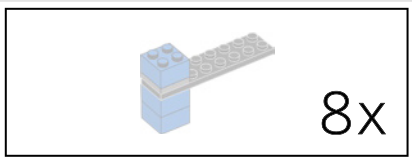

33

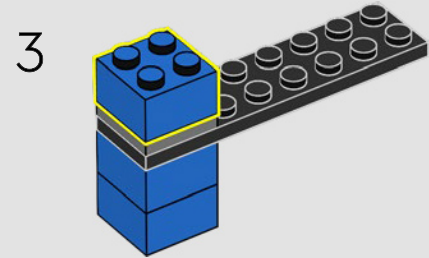
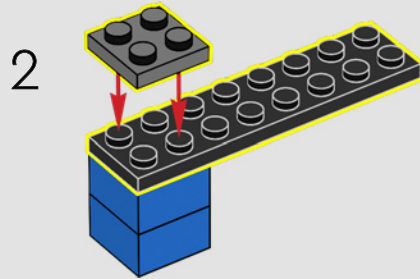
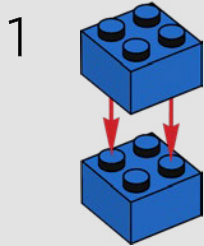

8x



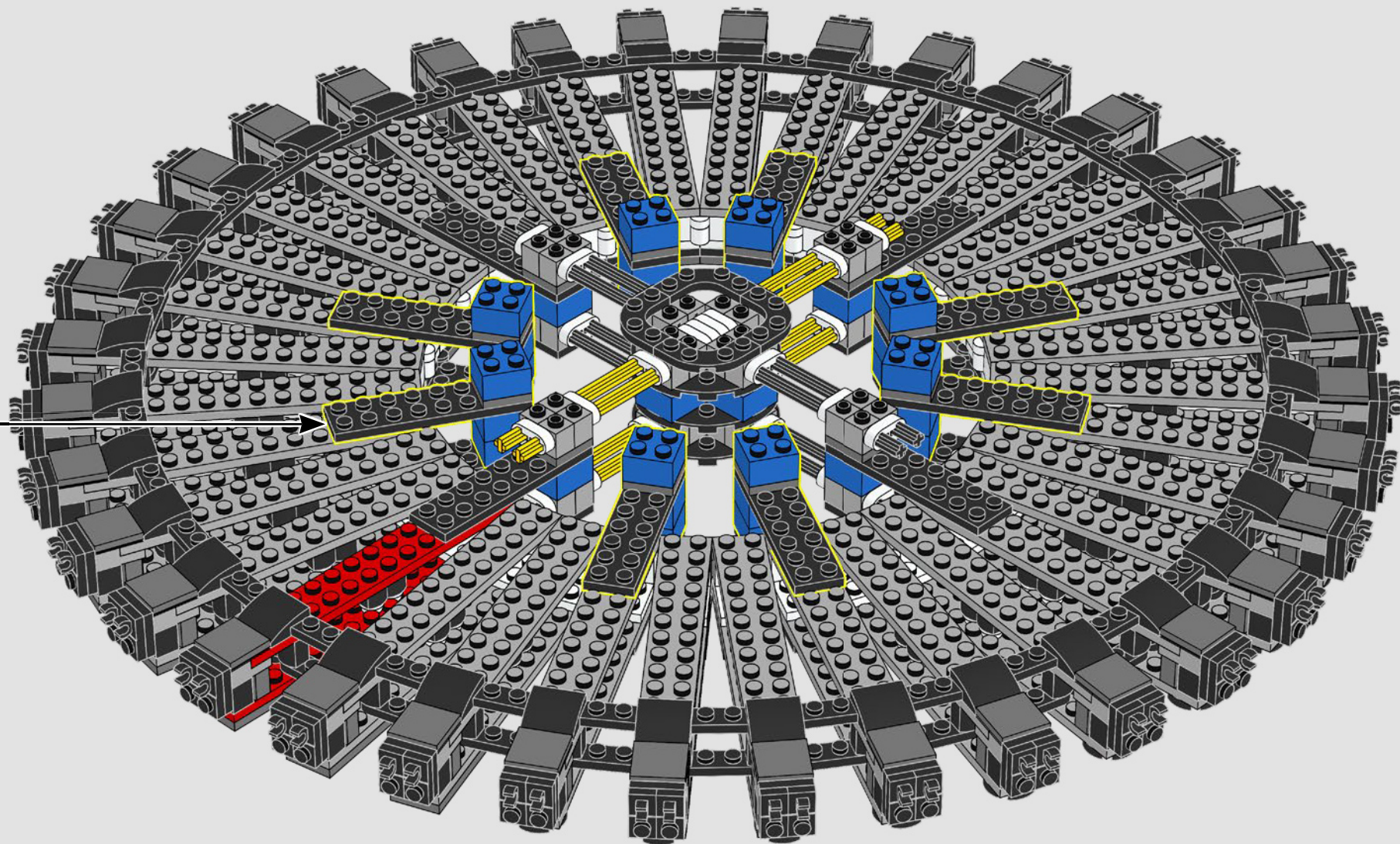

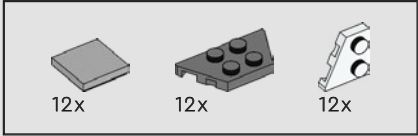
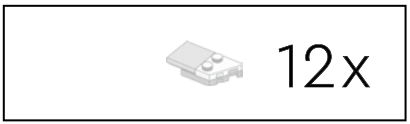

34

1

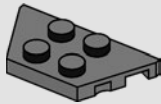

2

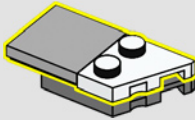

12x



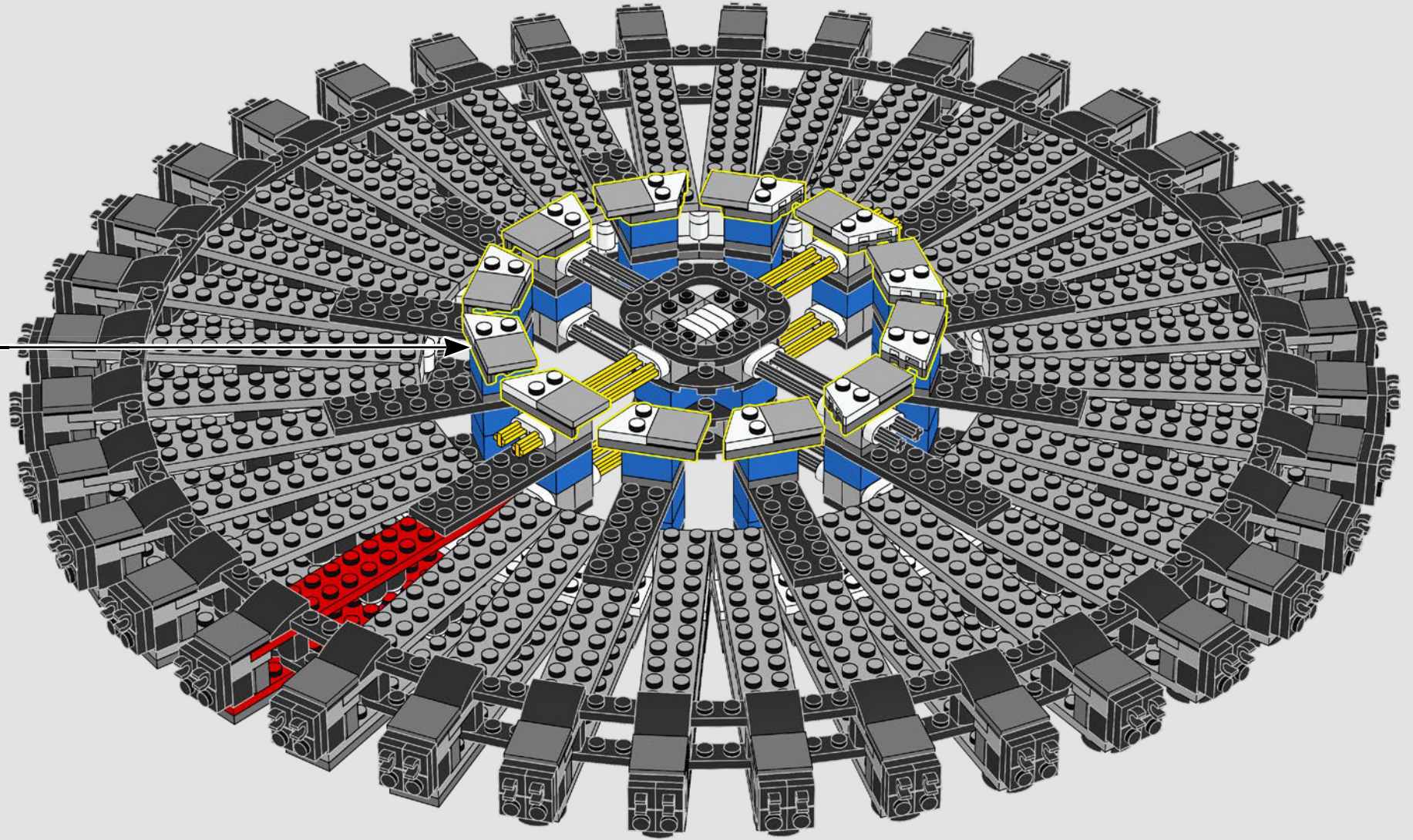

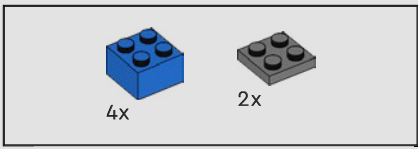

35

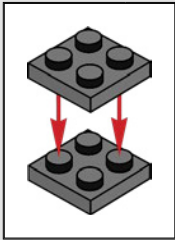
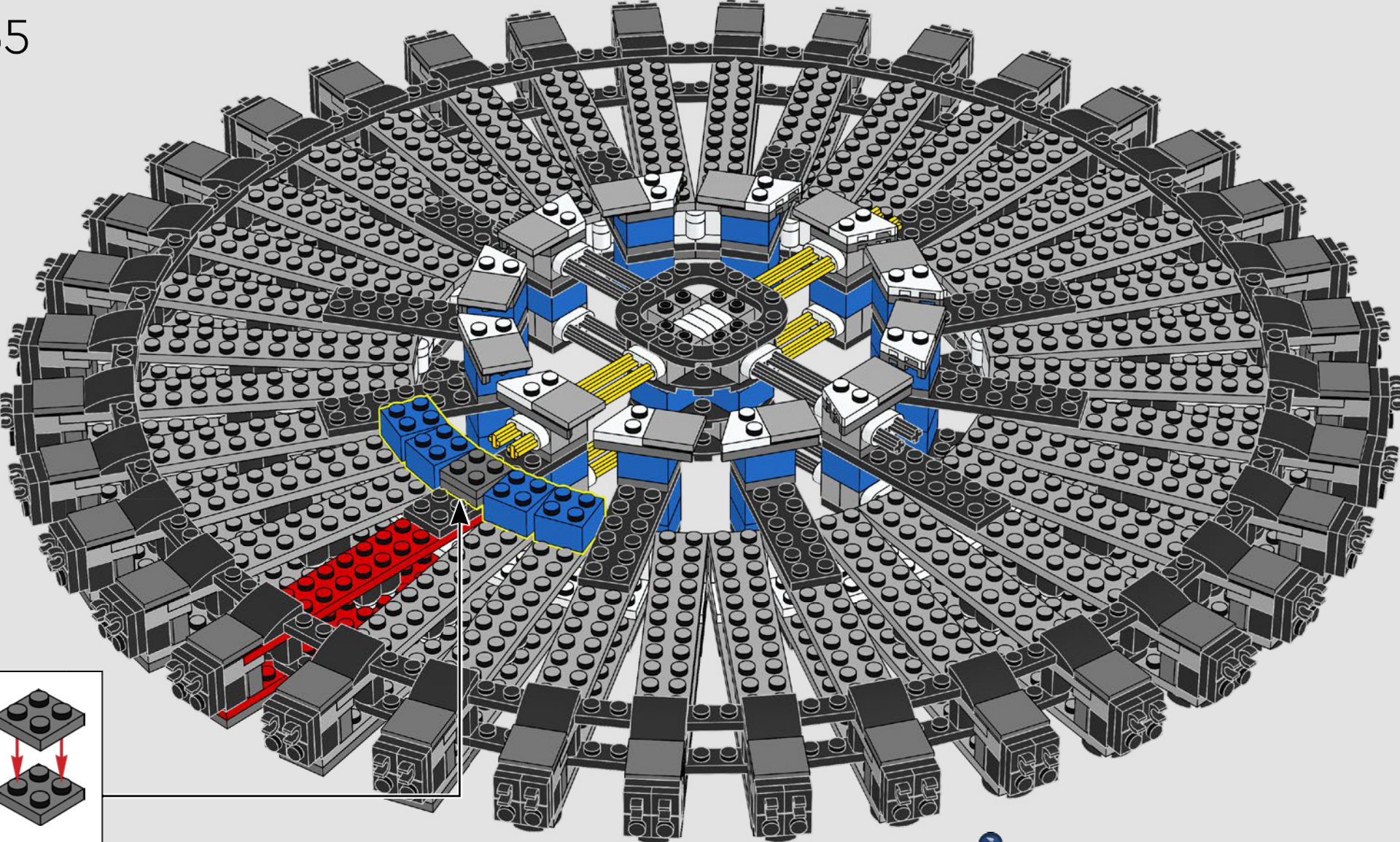



22x

36

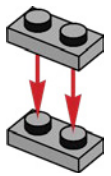
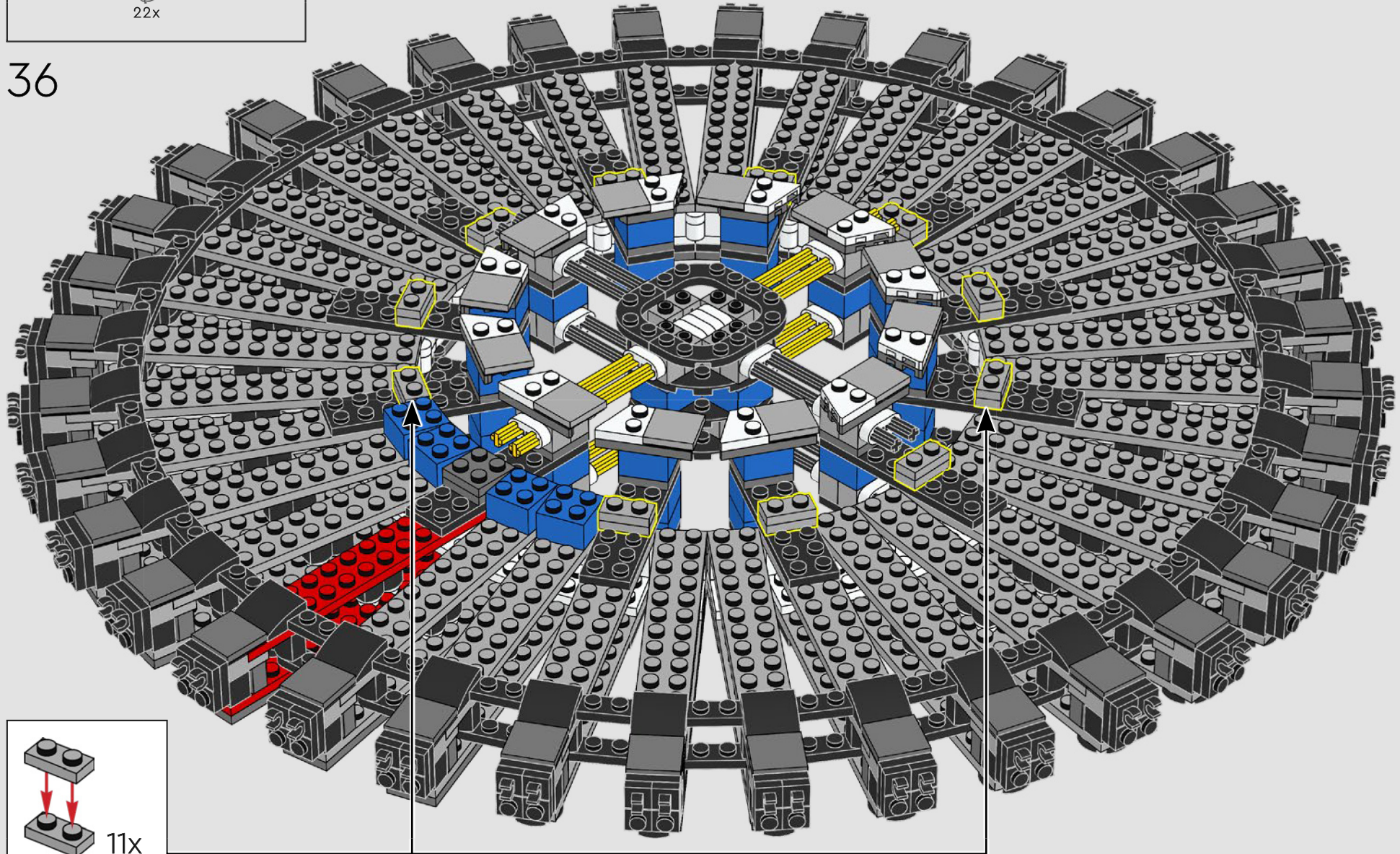

11x



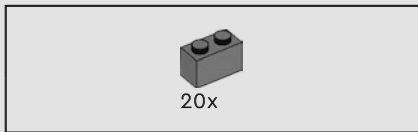

37

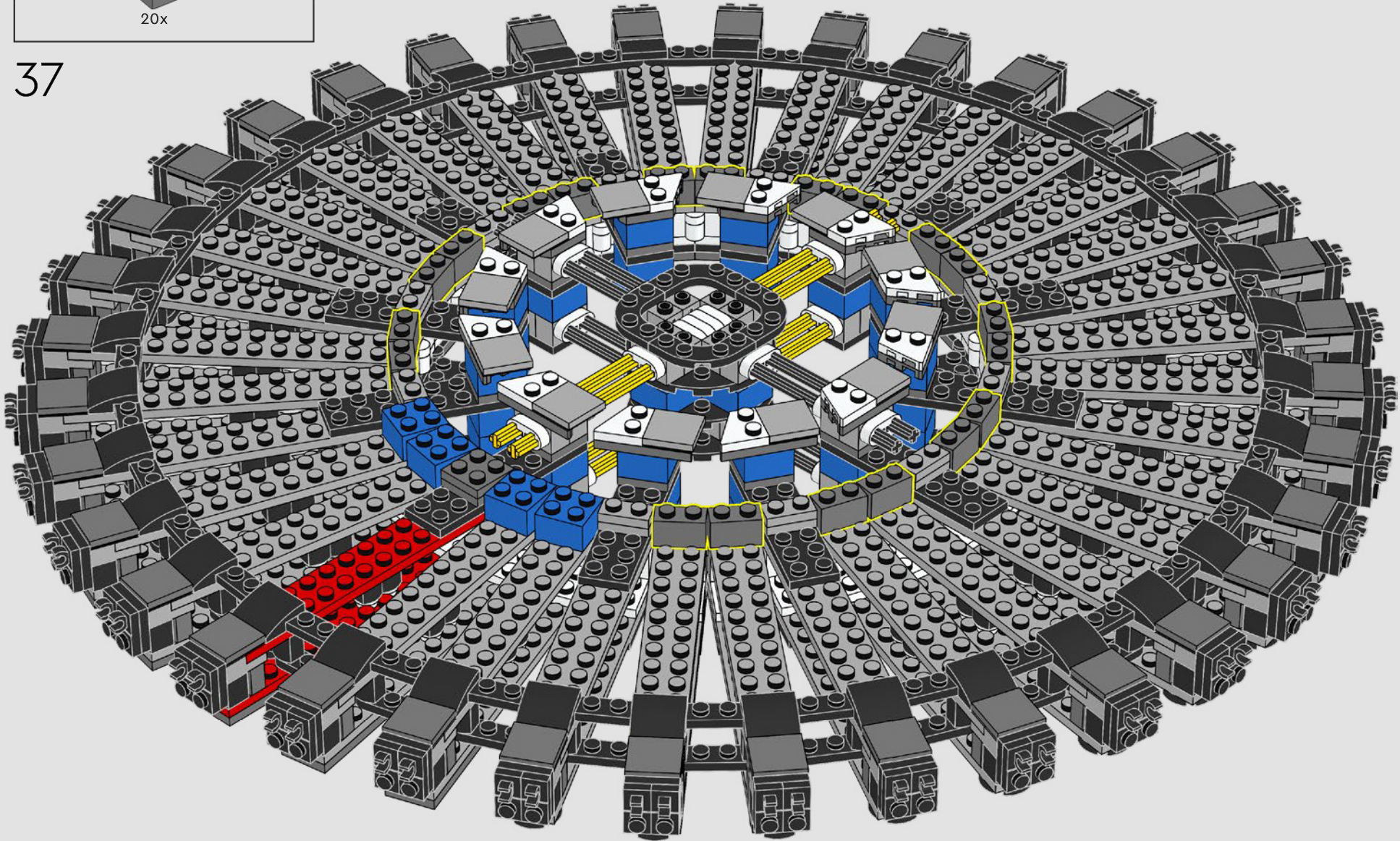

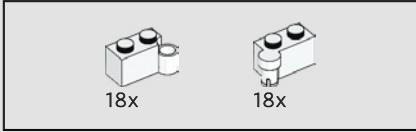
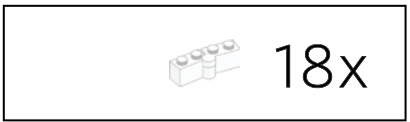

38

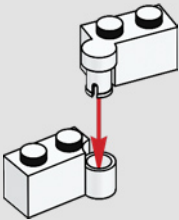

18x

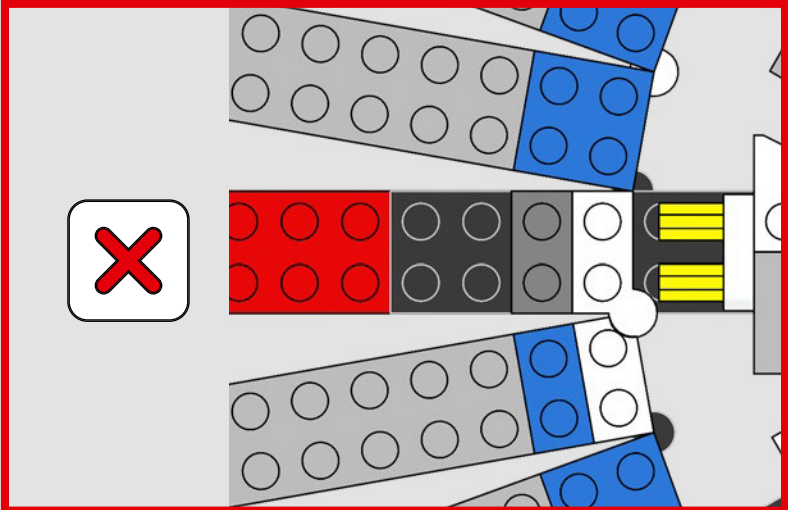
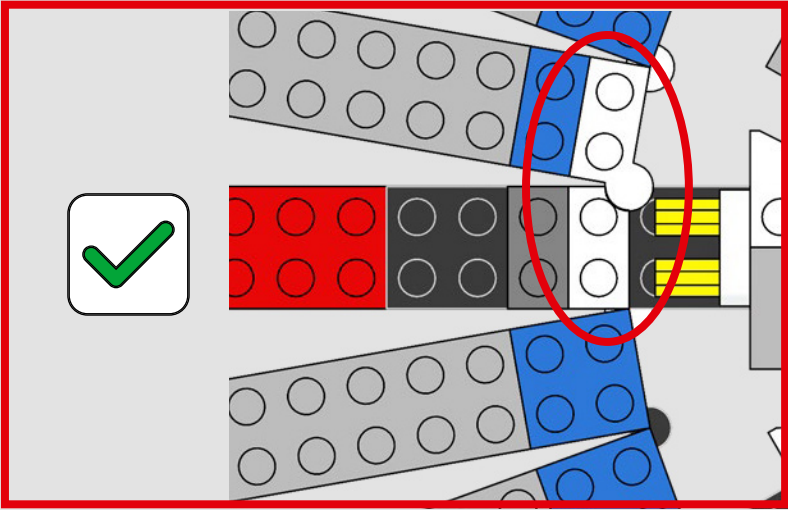

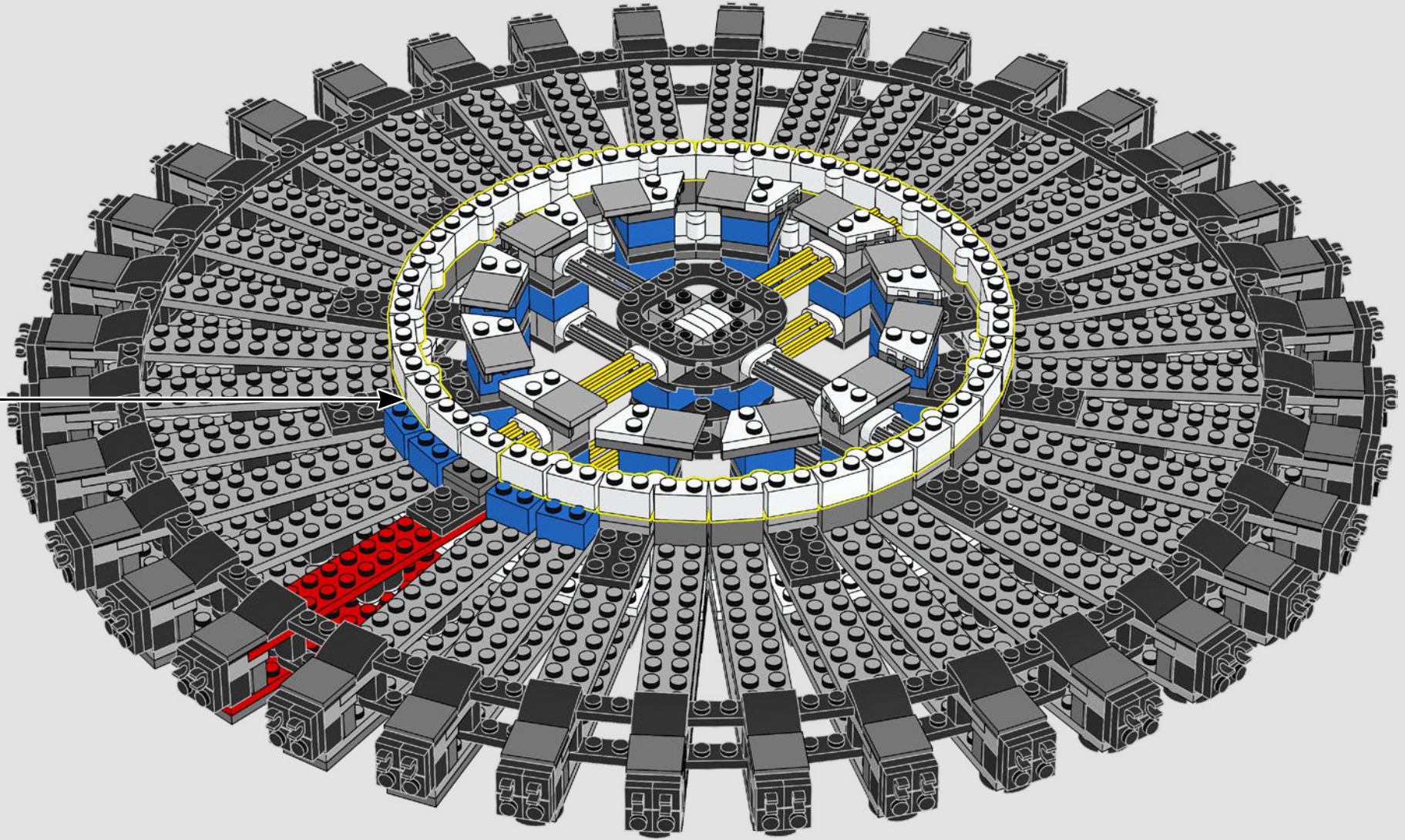

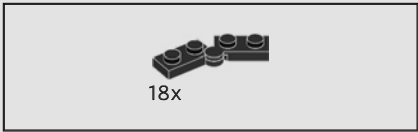

39

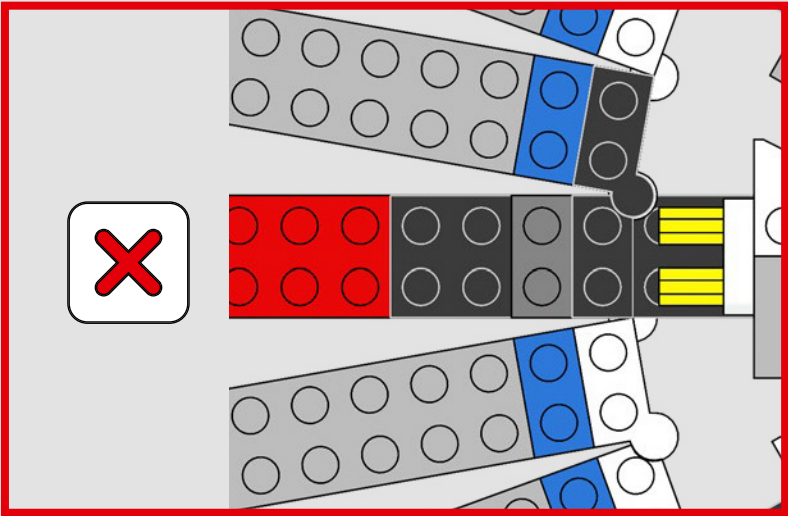
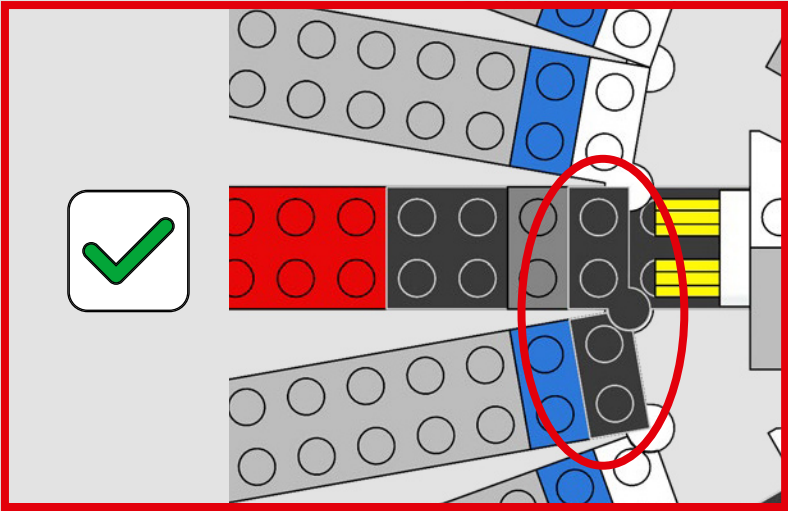

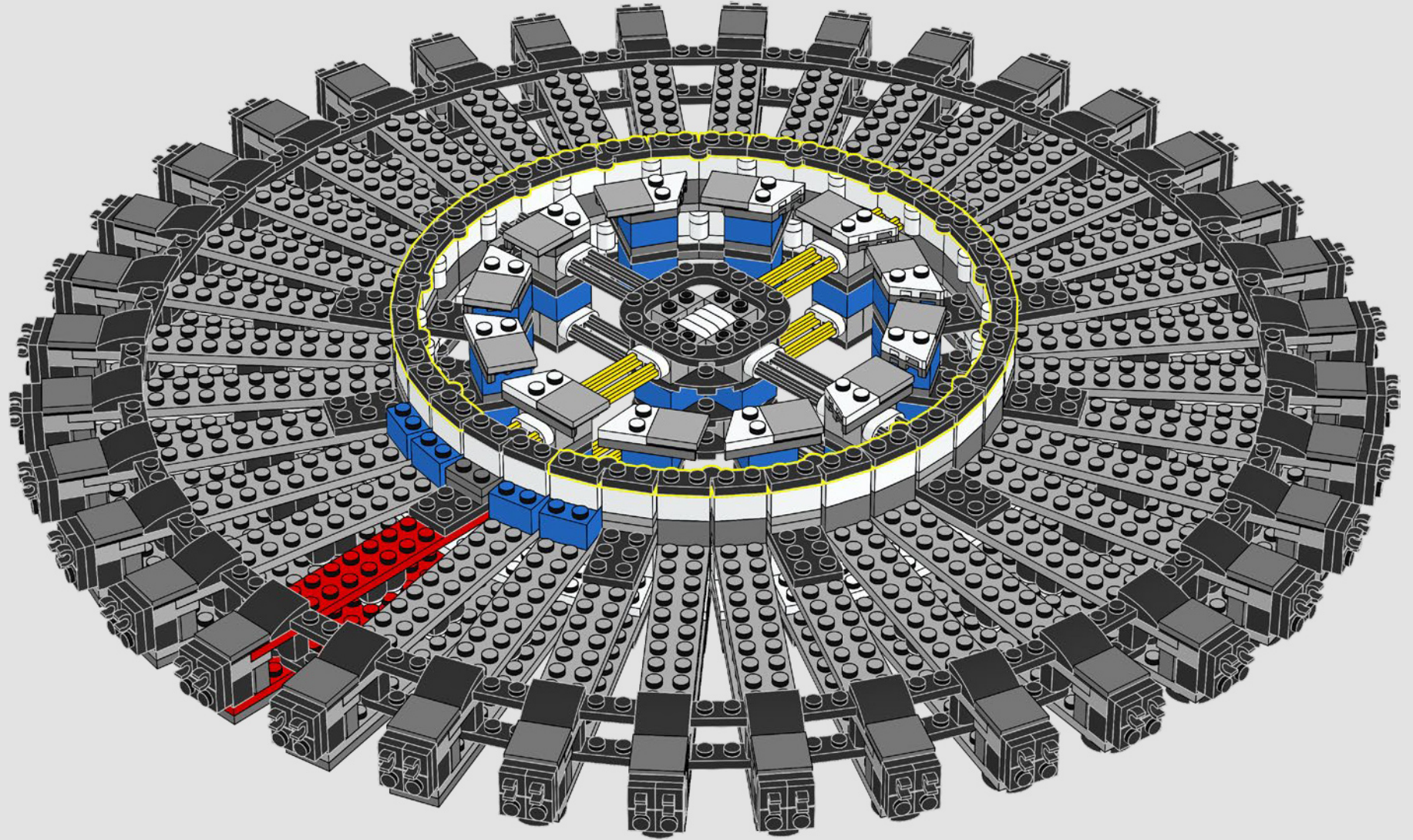



5x



5x



5 x

40

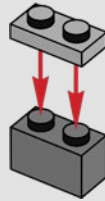

5x



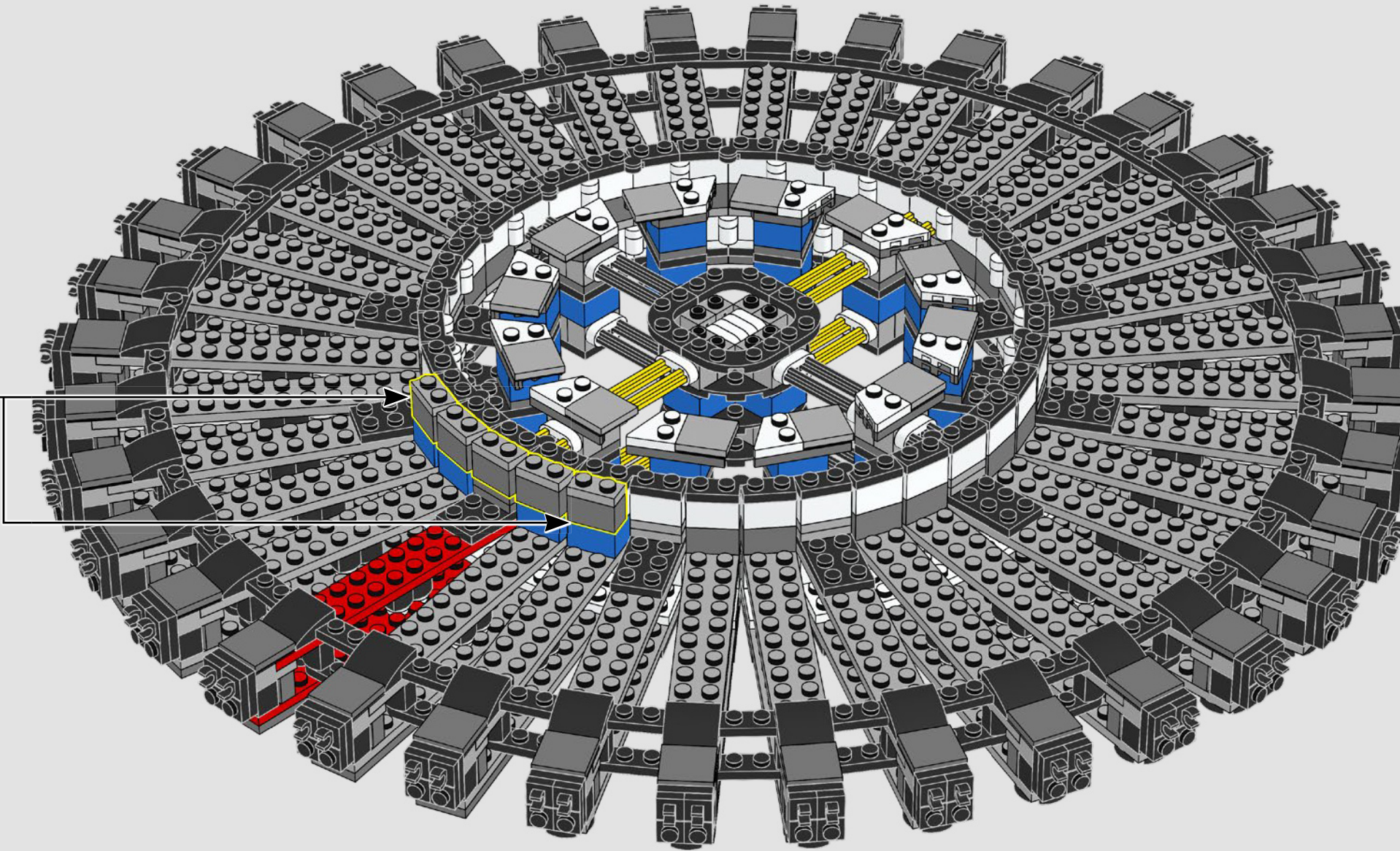



18x



18x



36x



18x

41

1

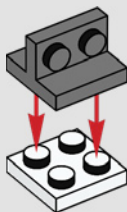

2

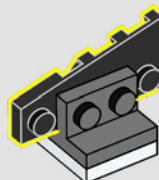

3

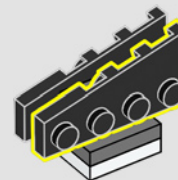

18x



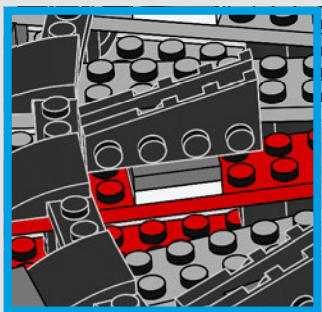
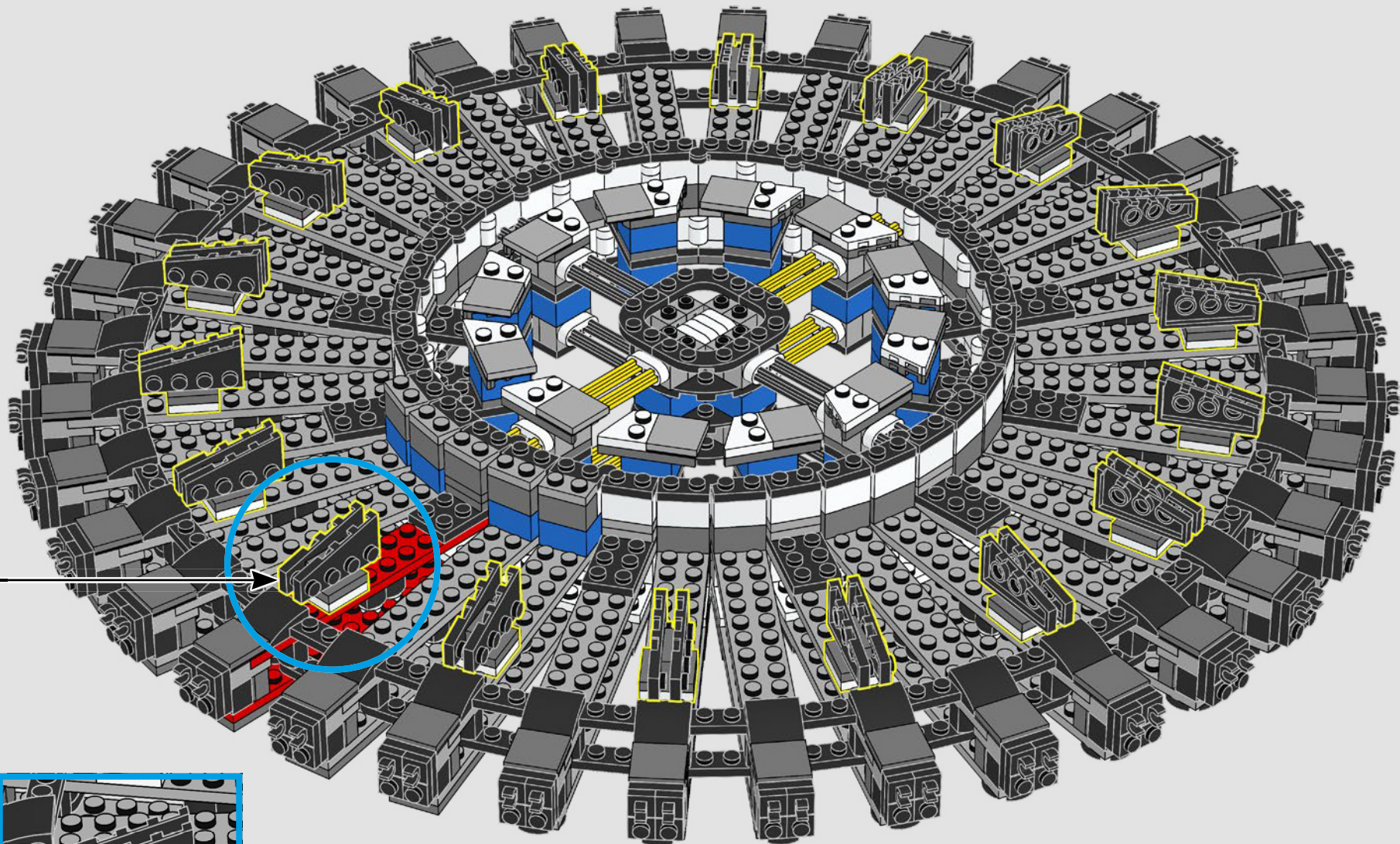

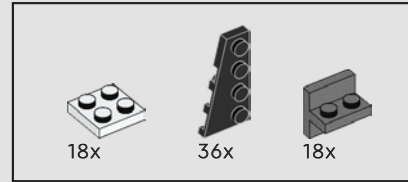
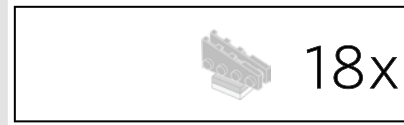

42

1

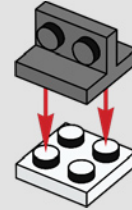

2

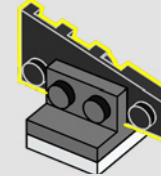

3

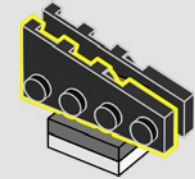

18x



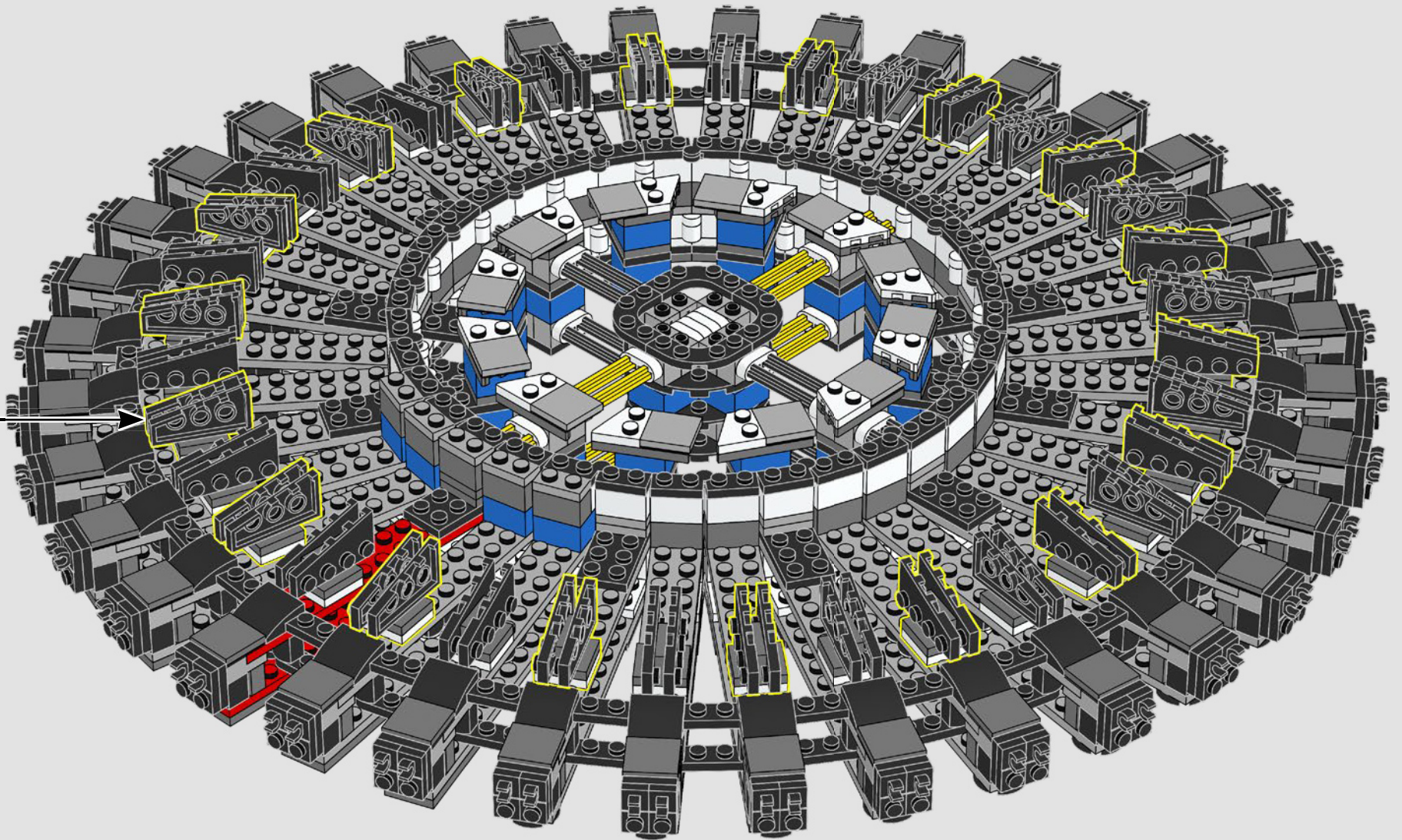



36x

43

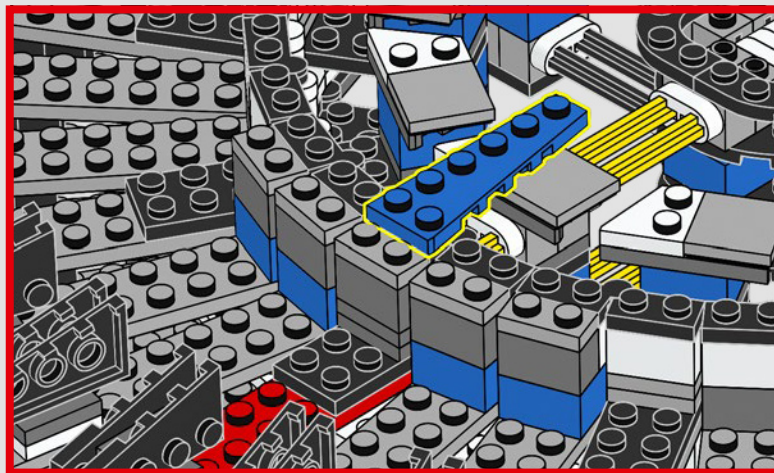

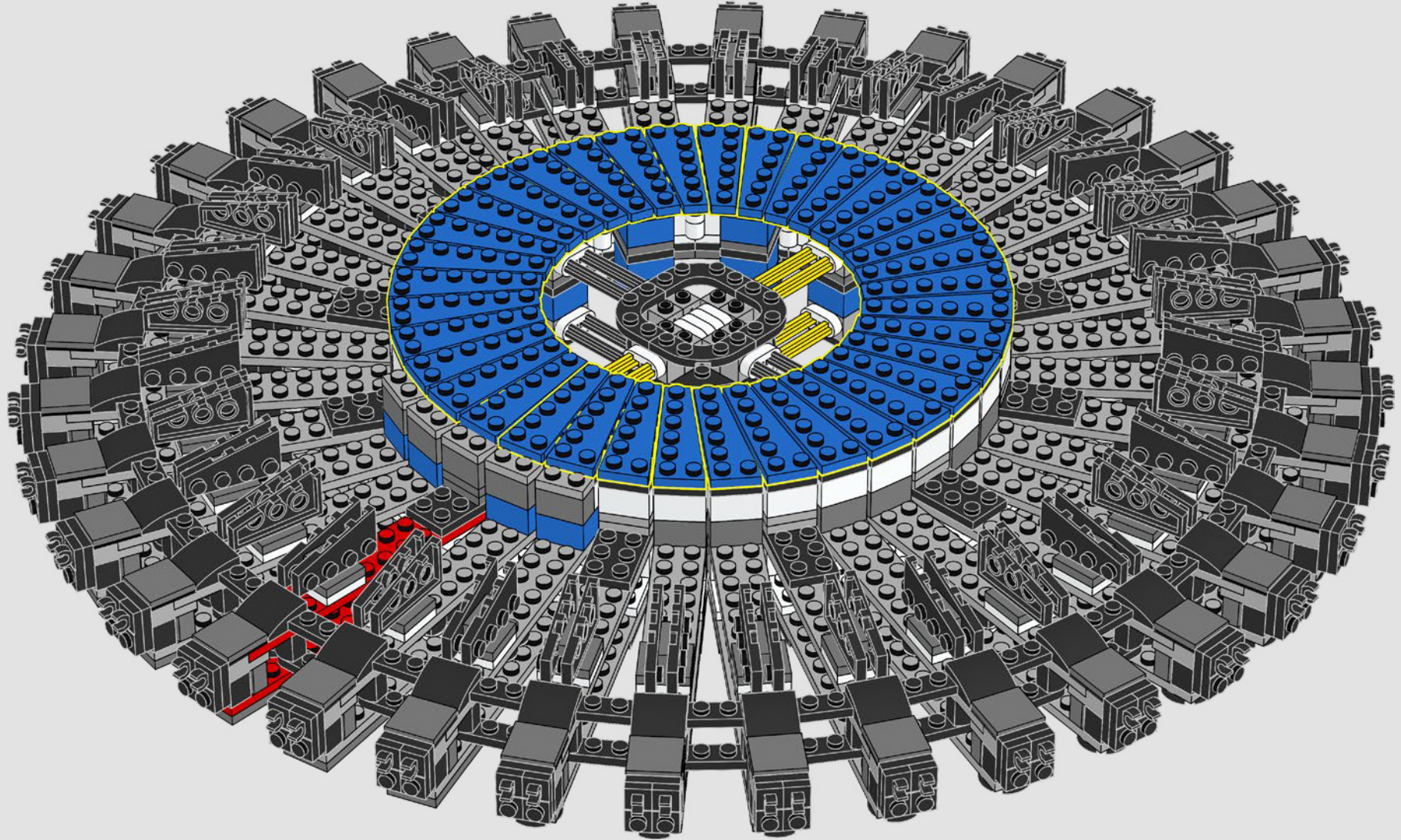

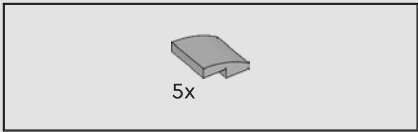

44

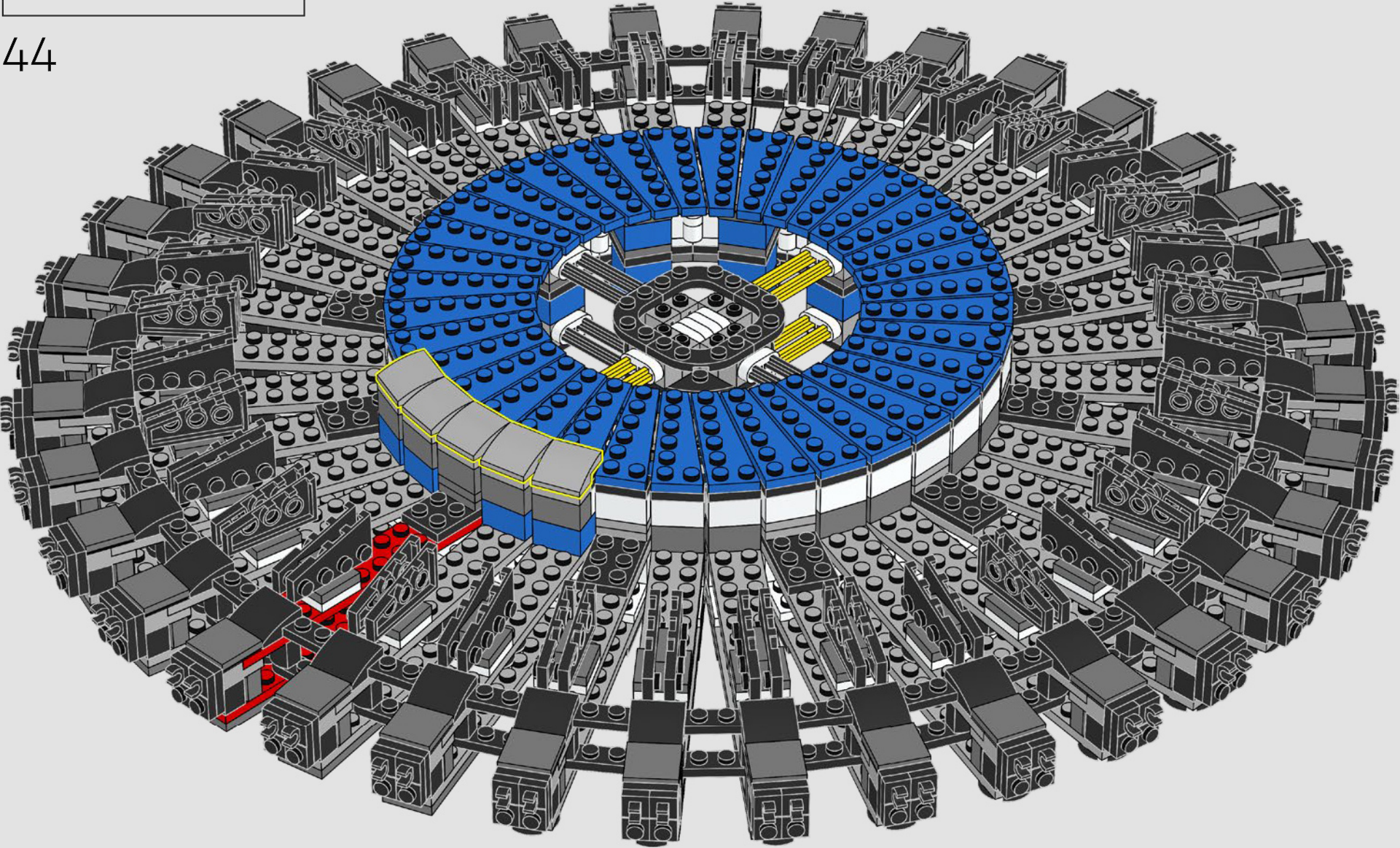



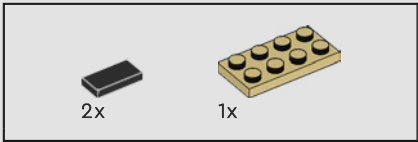

45

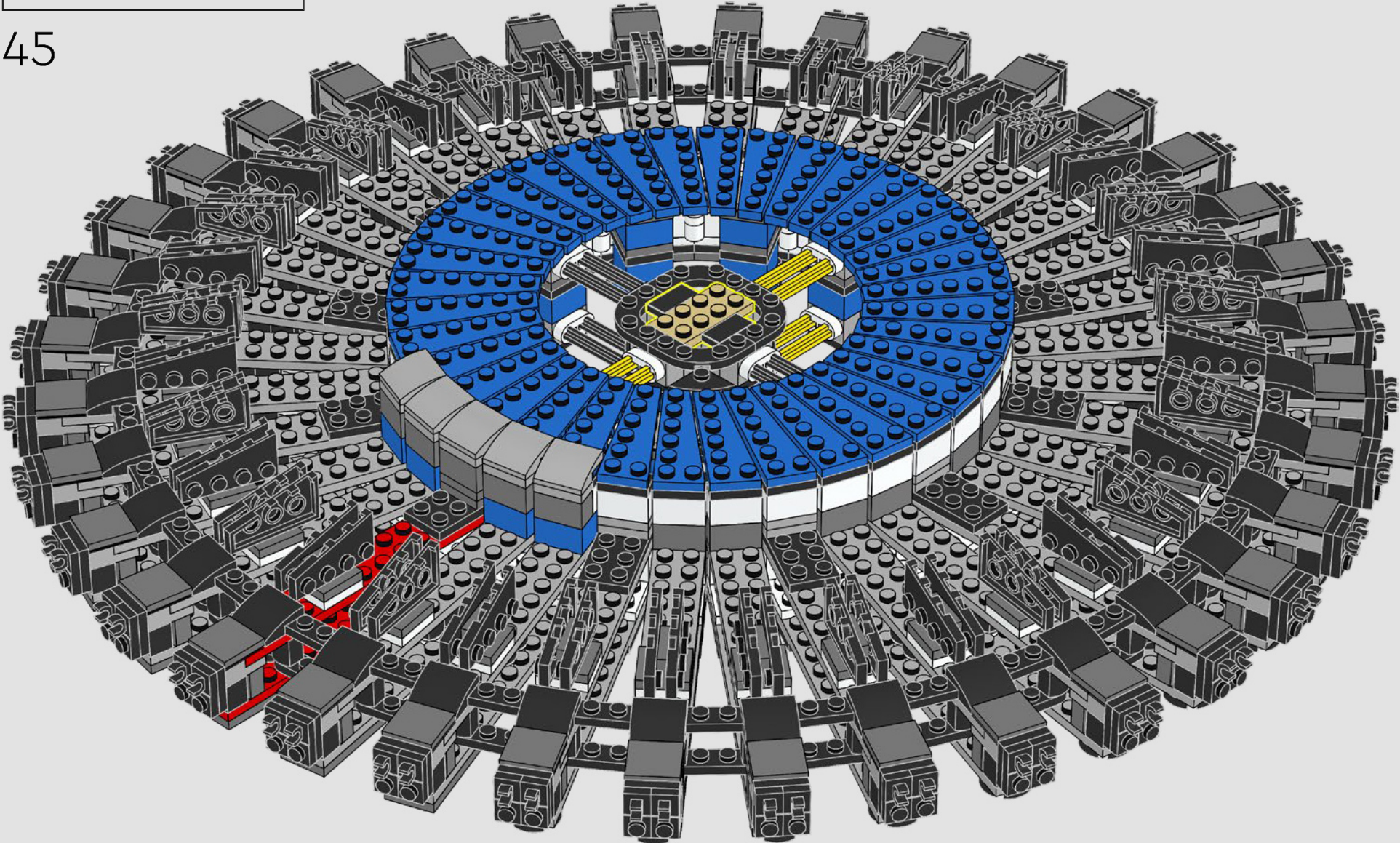

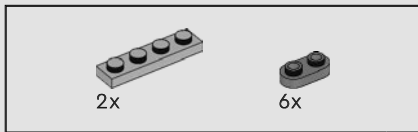

46

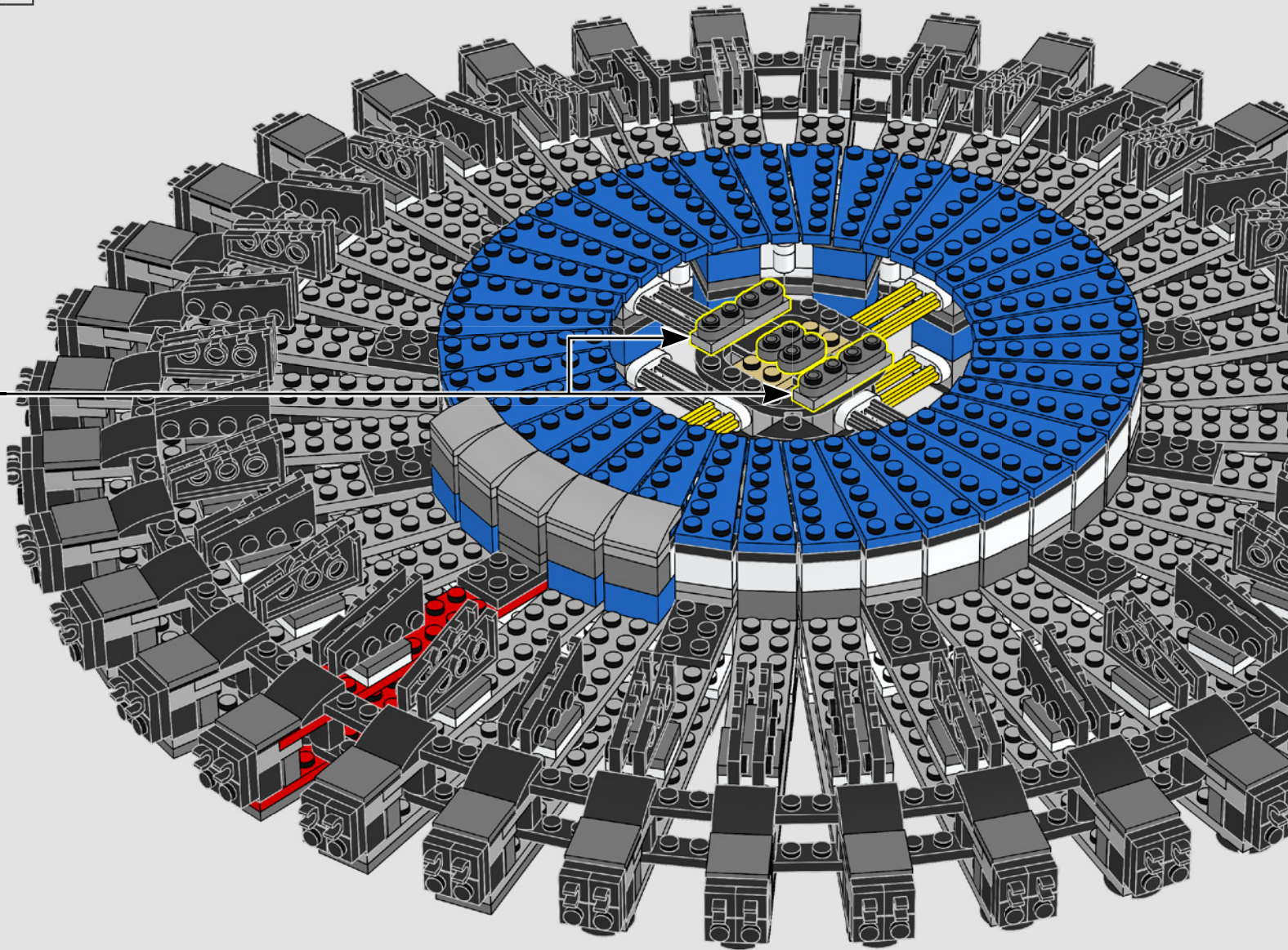
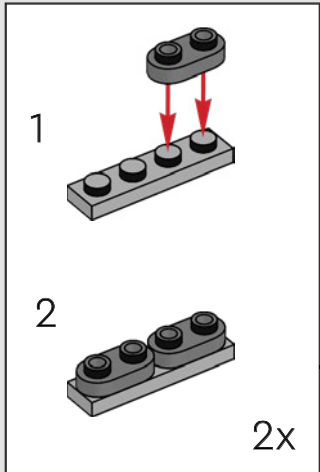

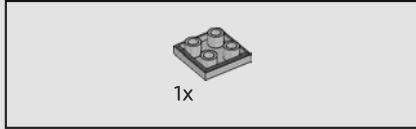
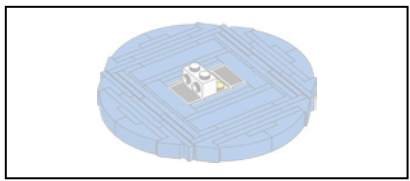

47

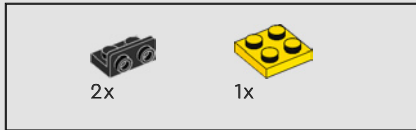

48

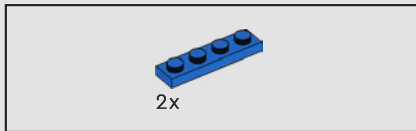

49

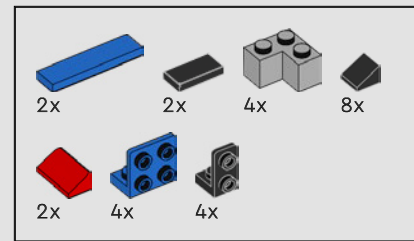
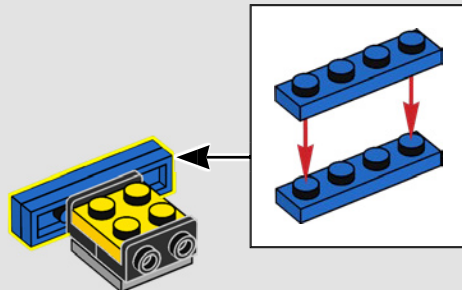
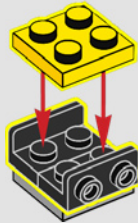
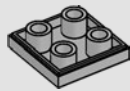

50

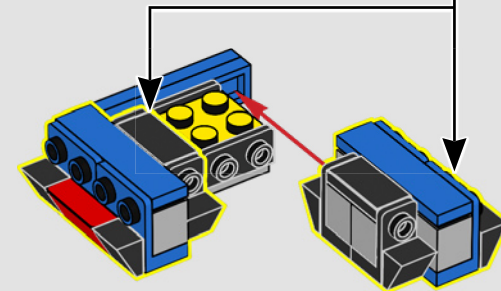
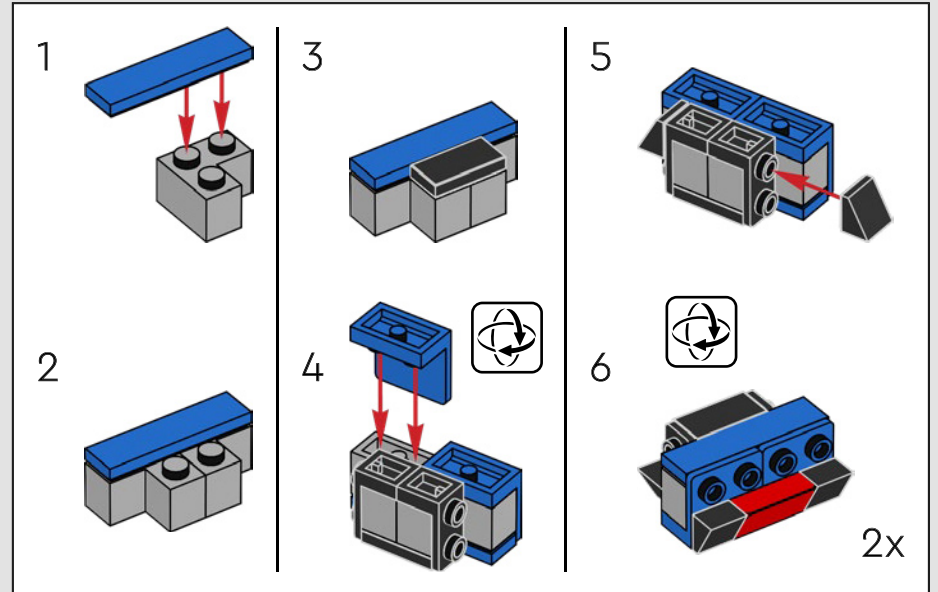

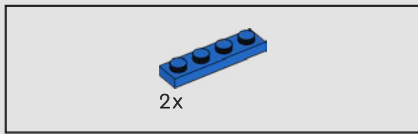

51

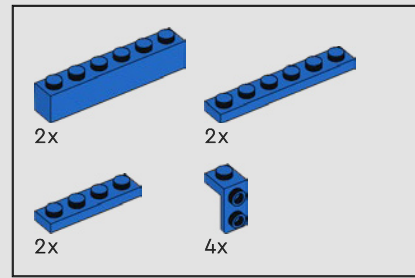
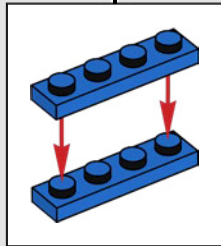
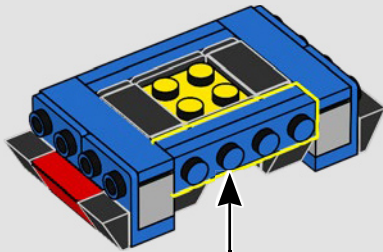

52

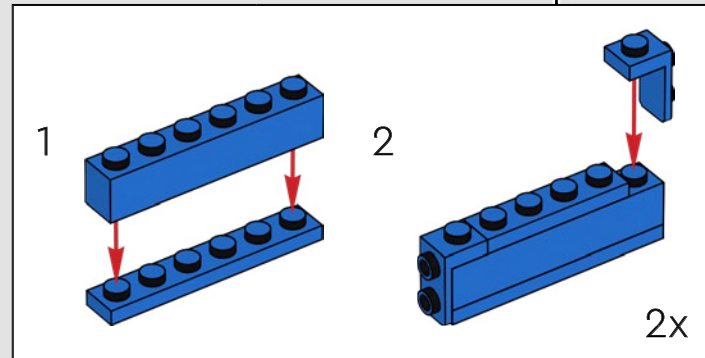
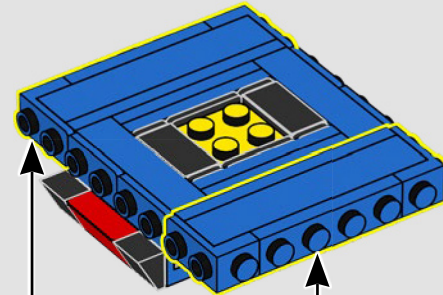

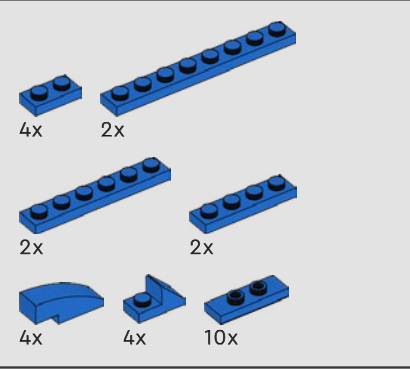
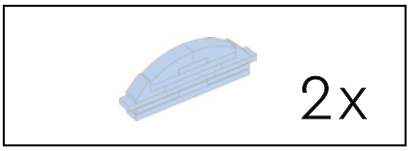

53

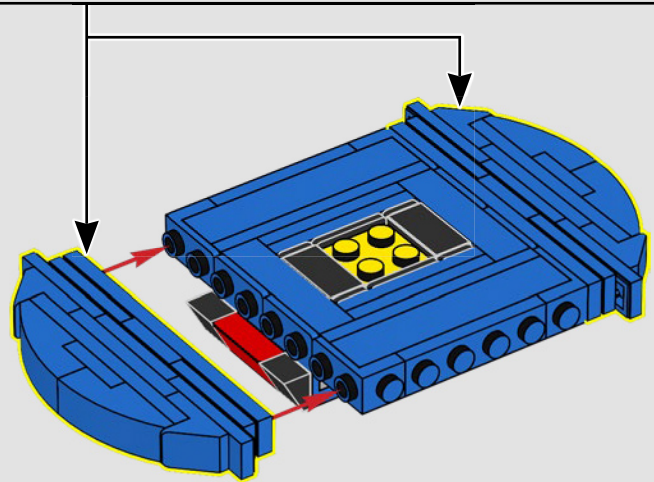
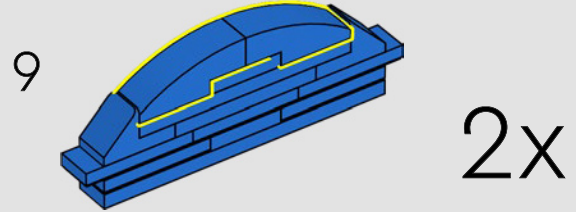
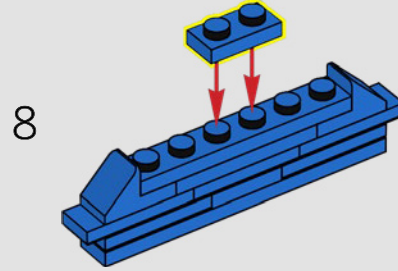
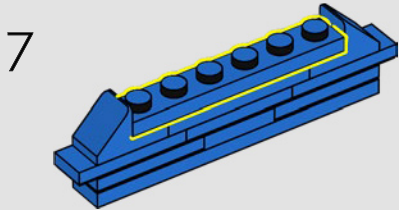
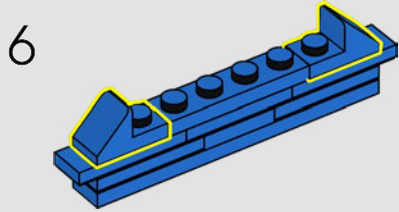
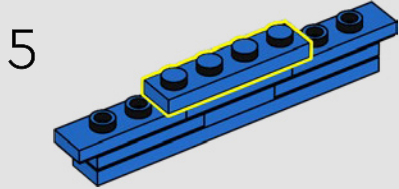
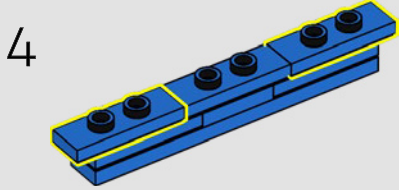
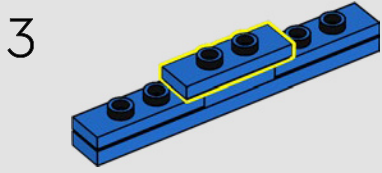
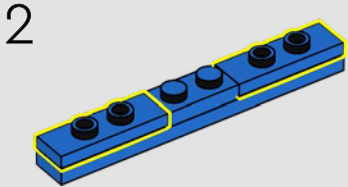
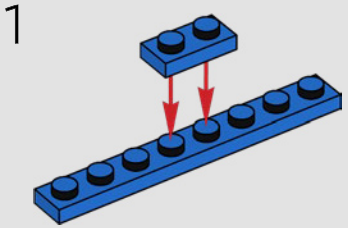

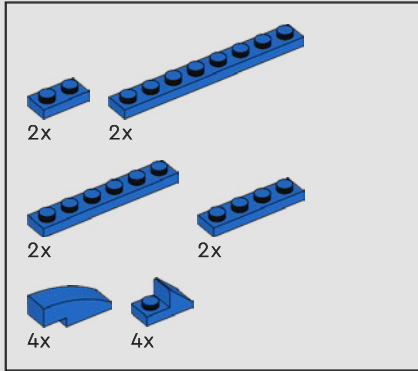
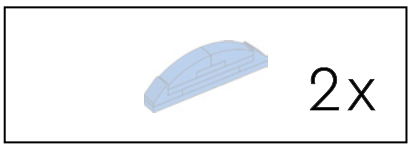

54

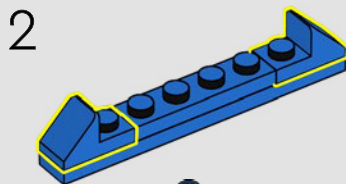
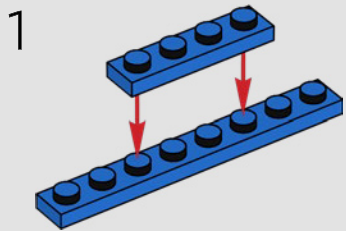

3

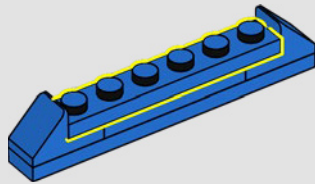

4

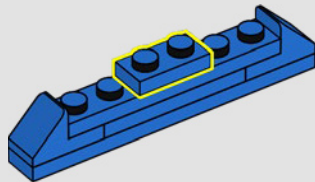

5

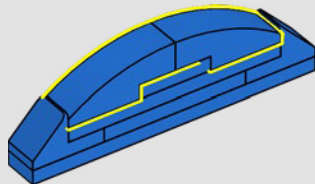

2x

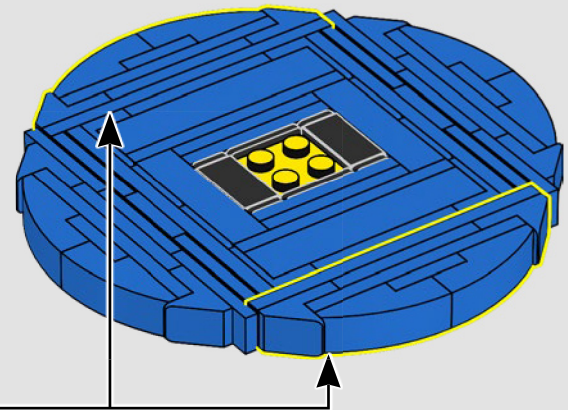



1x

55

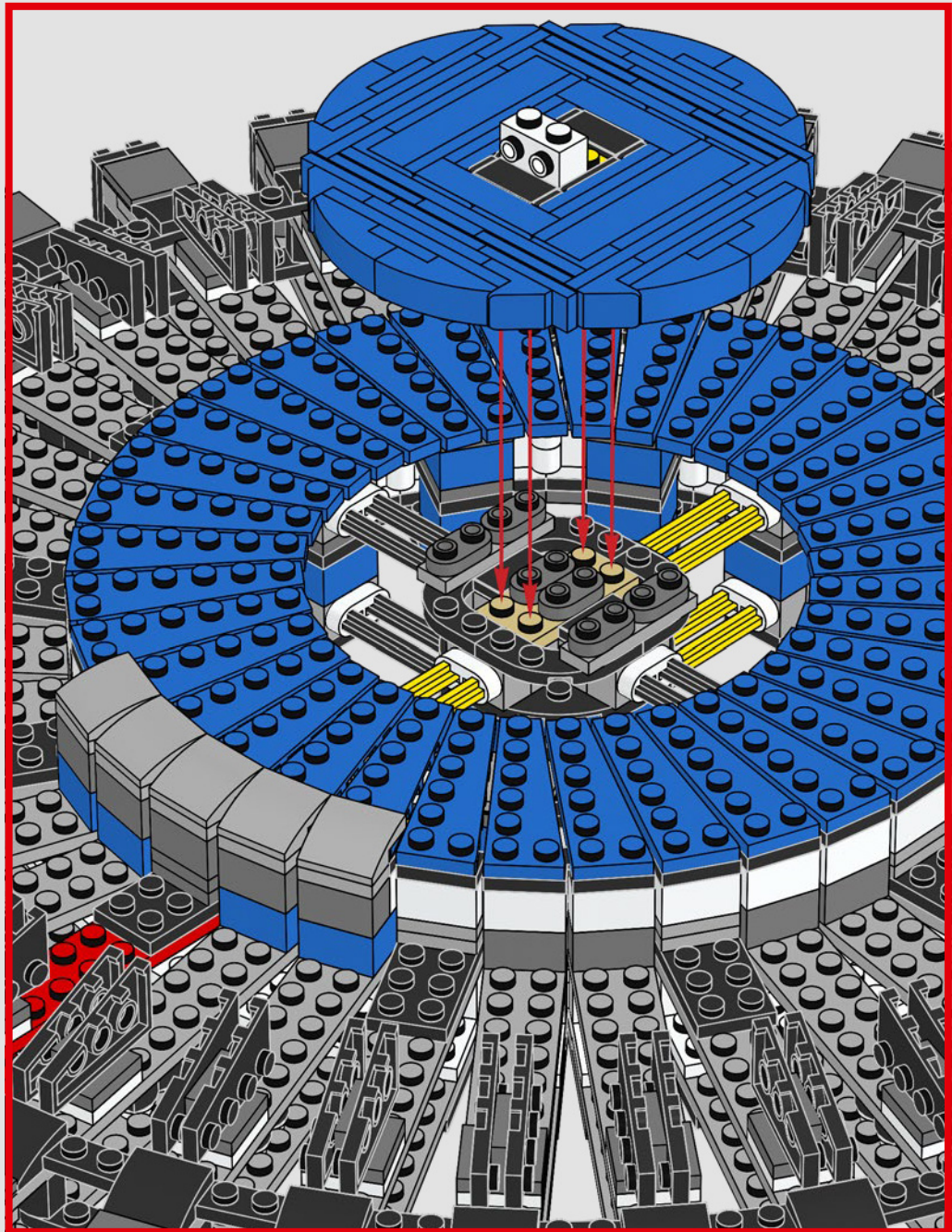
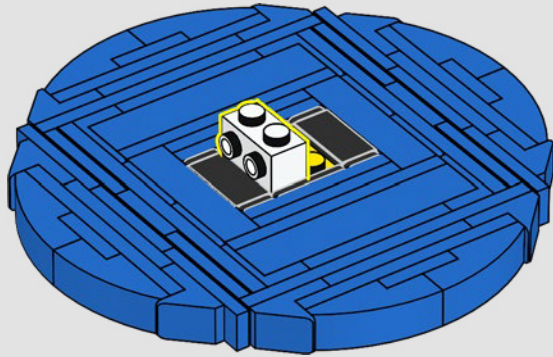

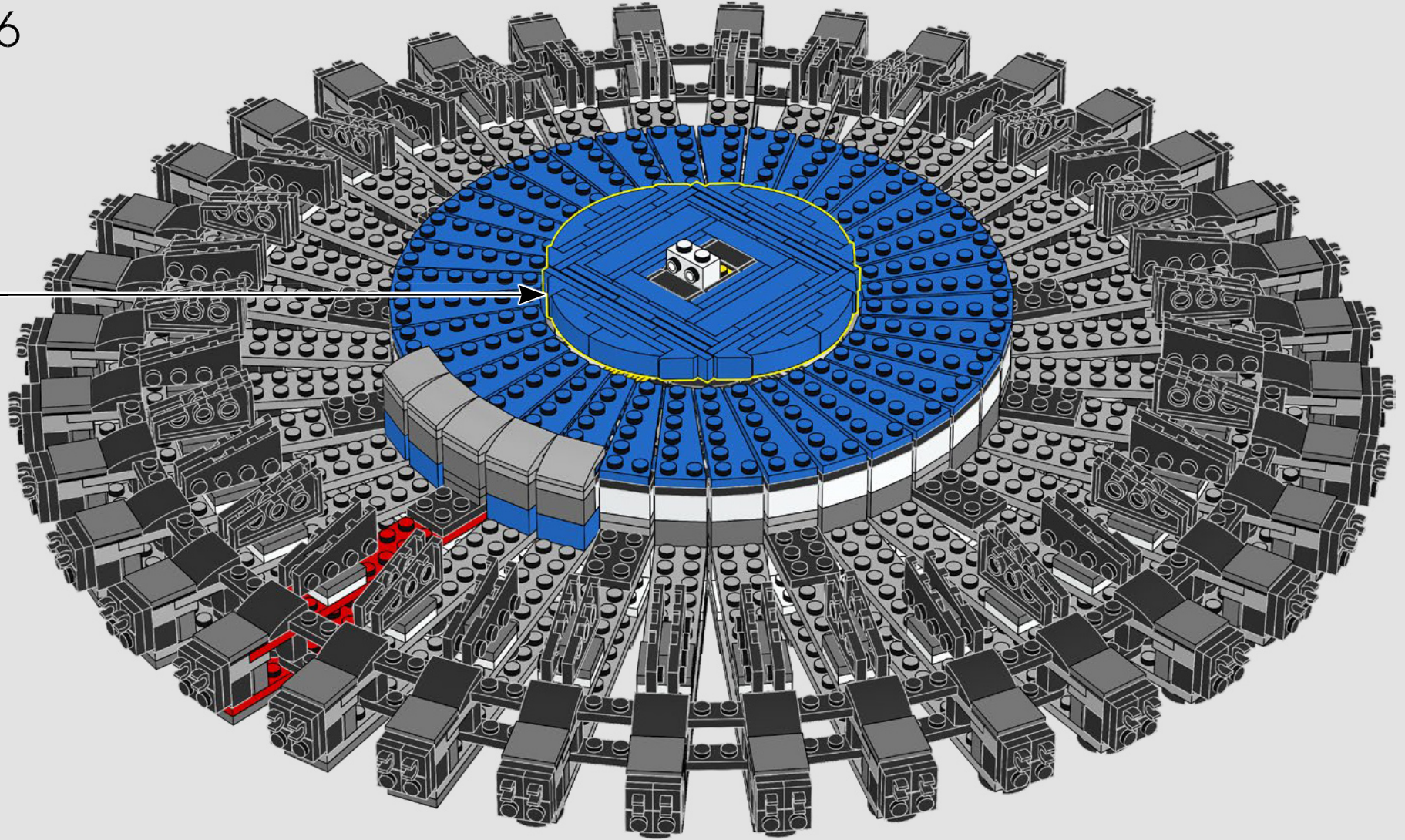

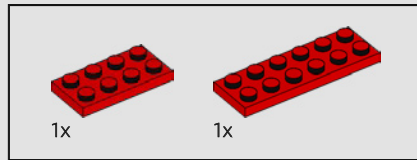
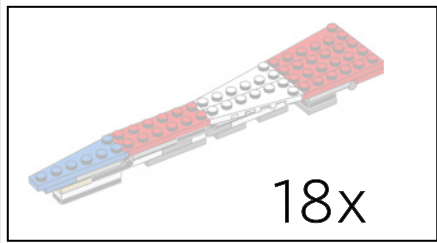

57

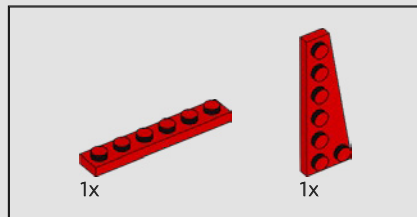
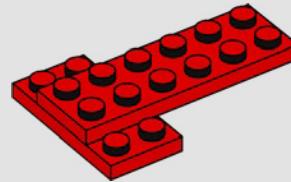

58

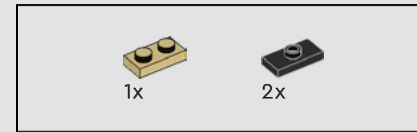
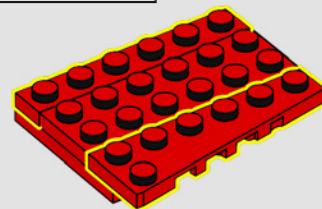

59

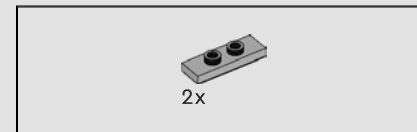
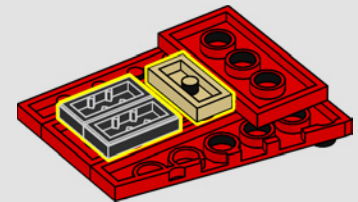
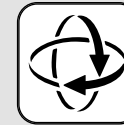

60

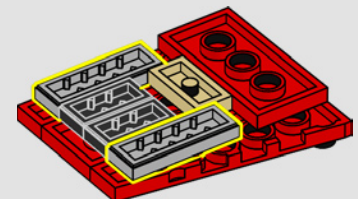

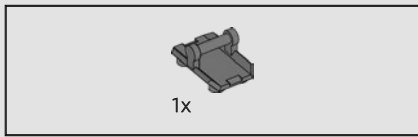

61

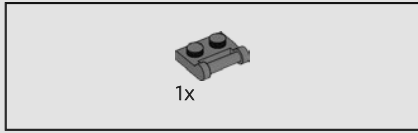
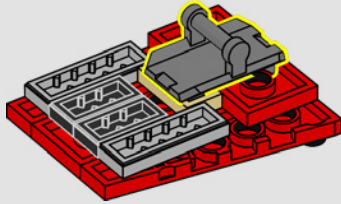

62

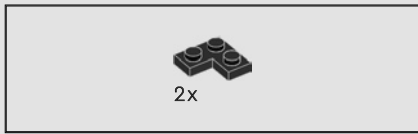
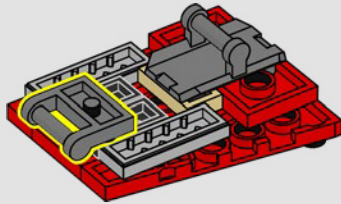

63

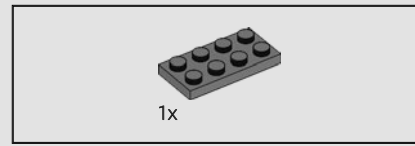
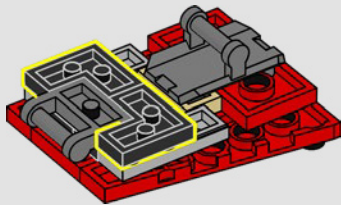

64

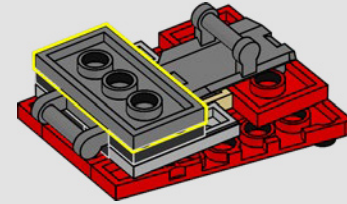

65

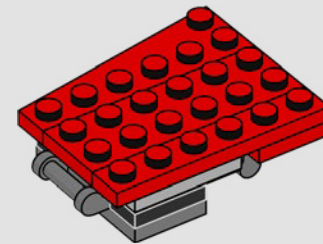
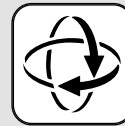

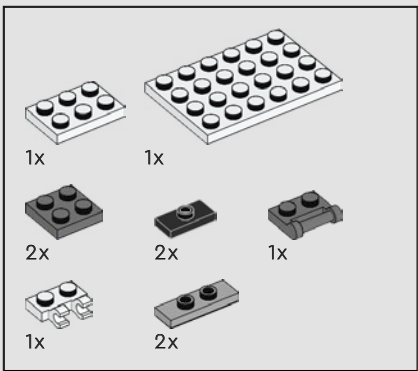

66

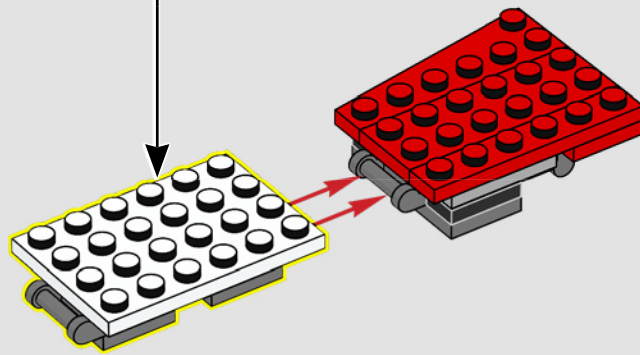
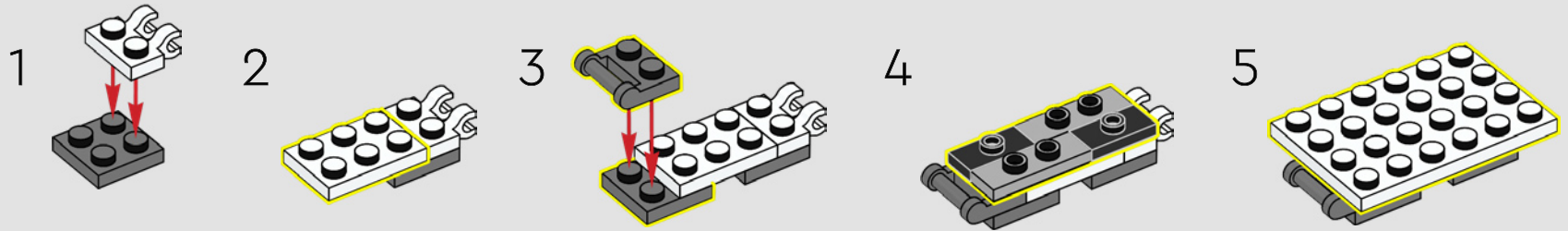

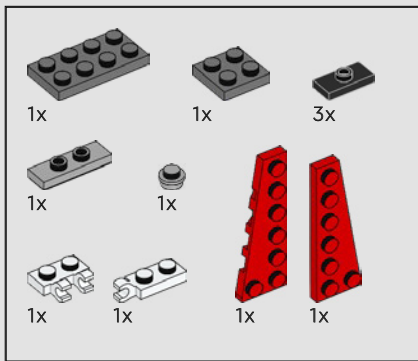

67

1

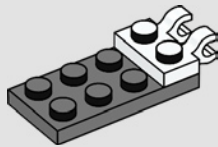

2

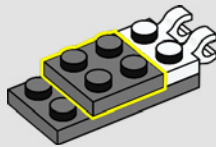

3

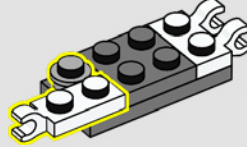

4

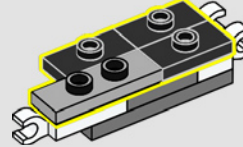

5

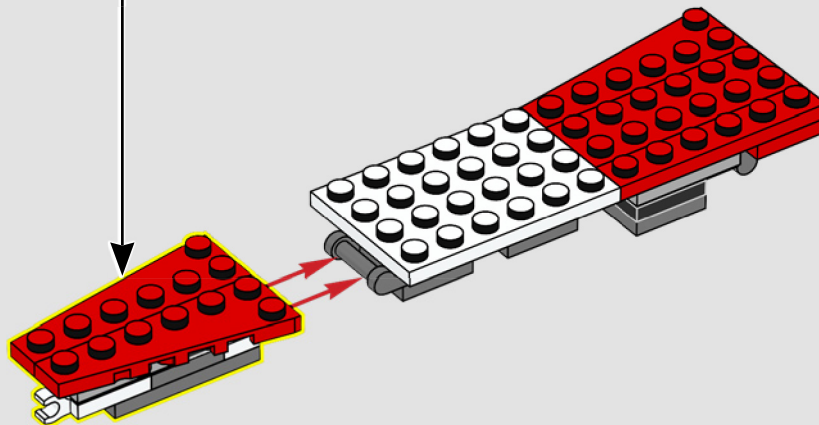
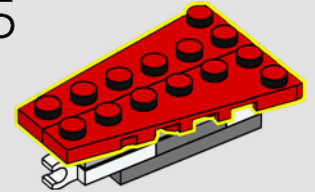

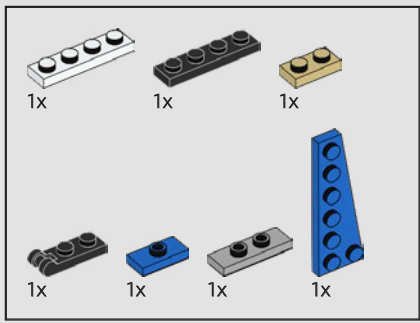

68

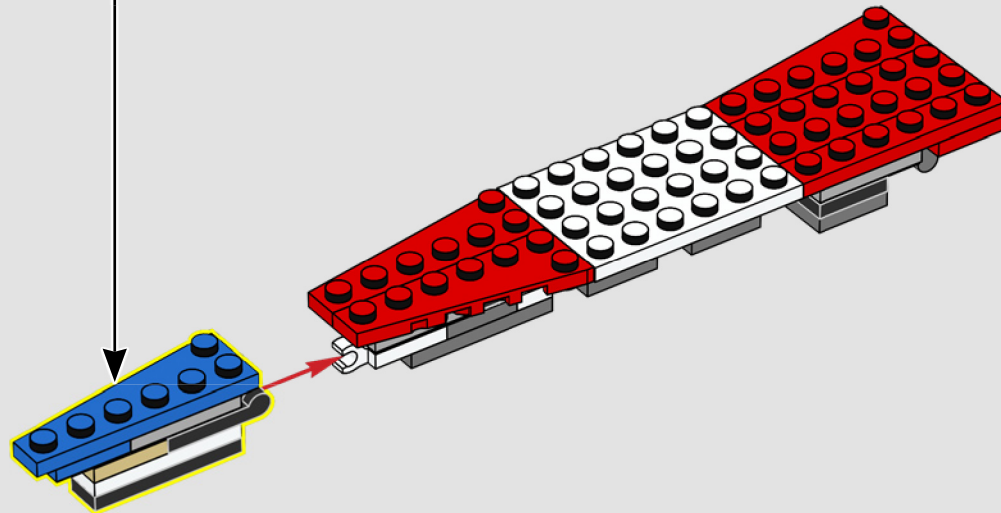
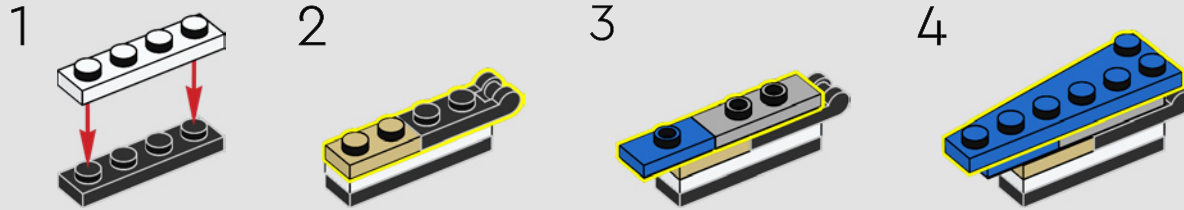

18x

69

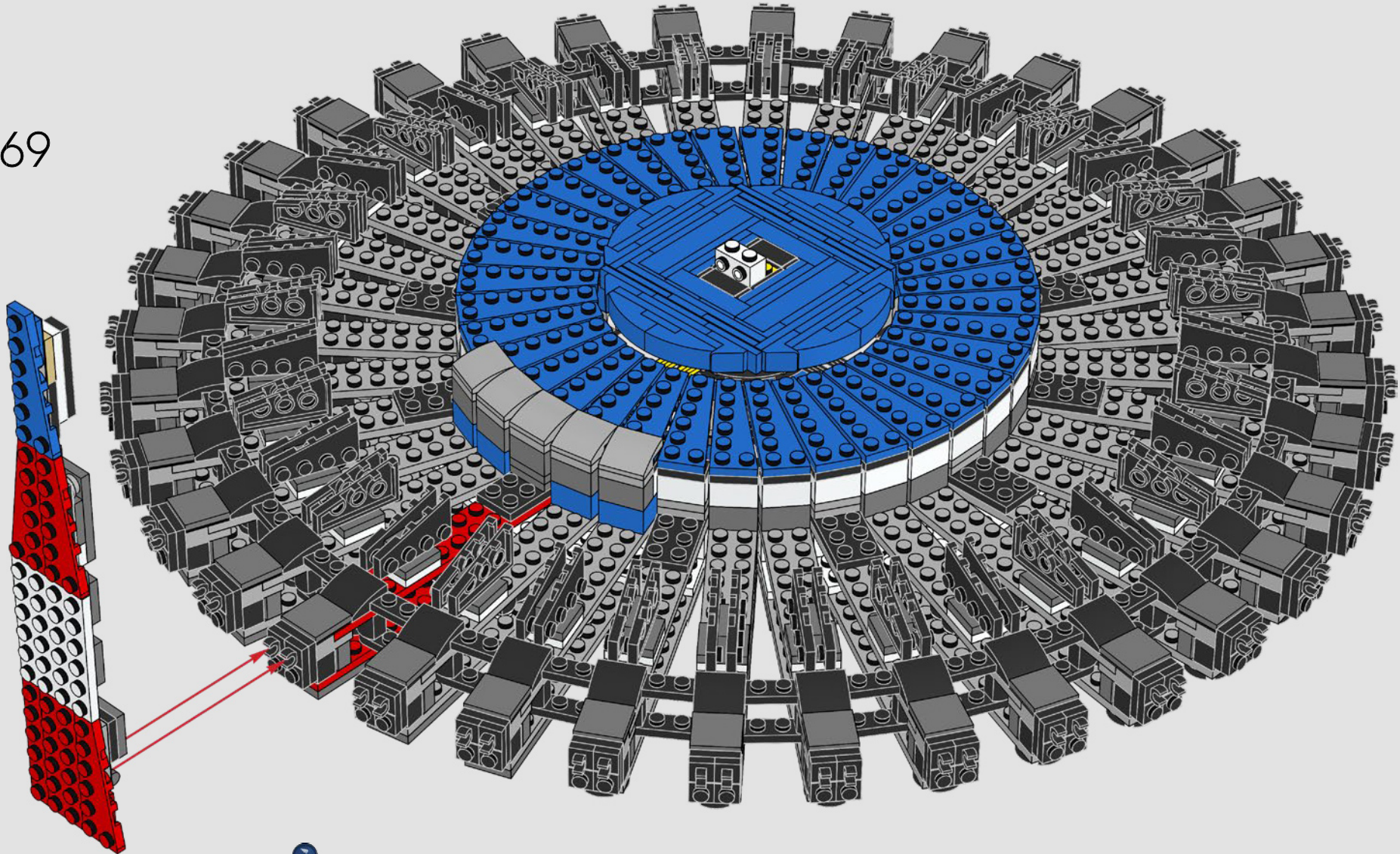

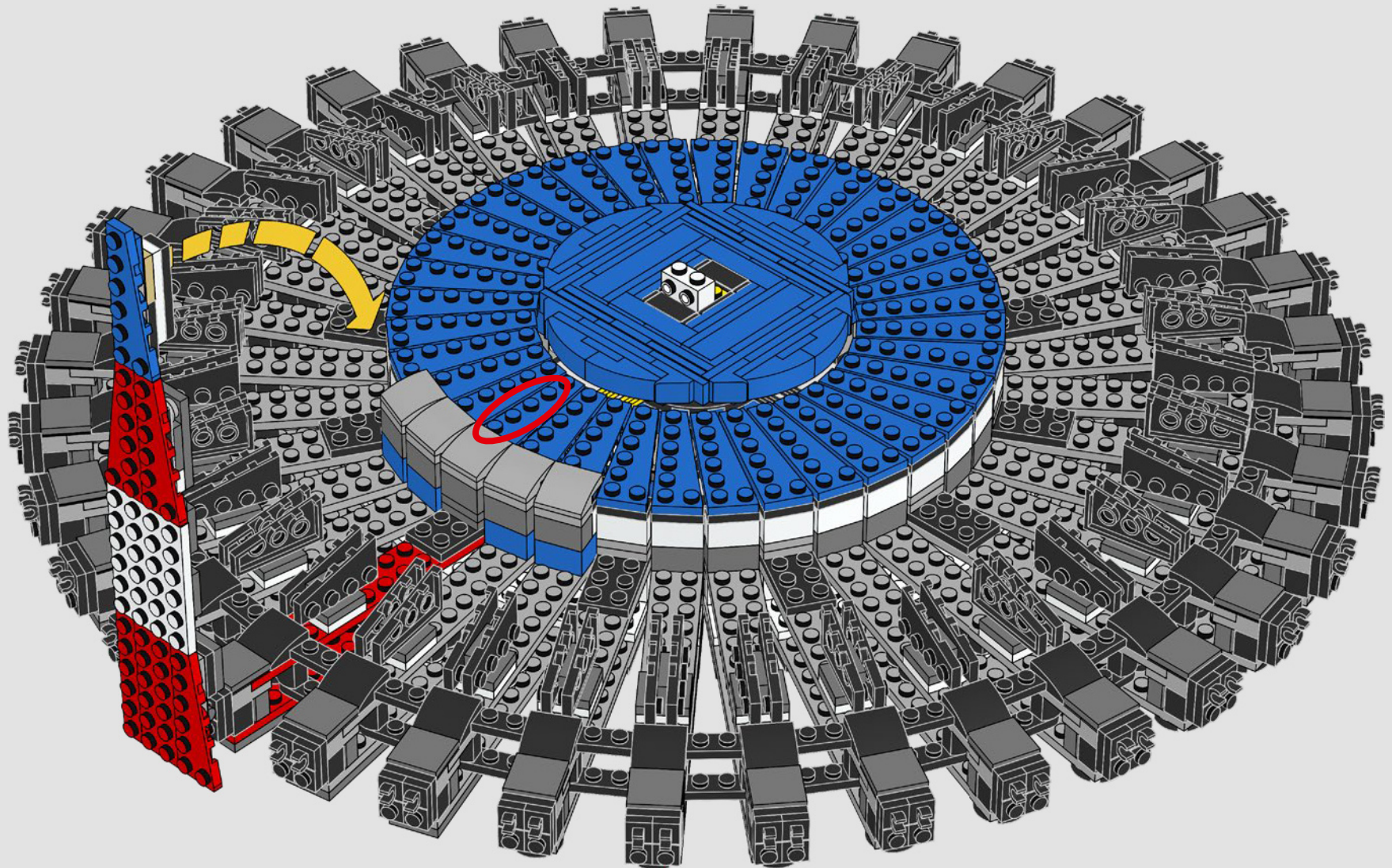

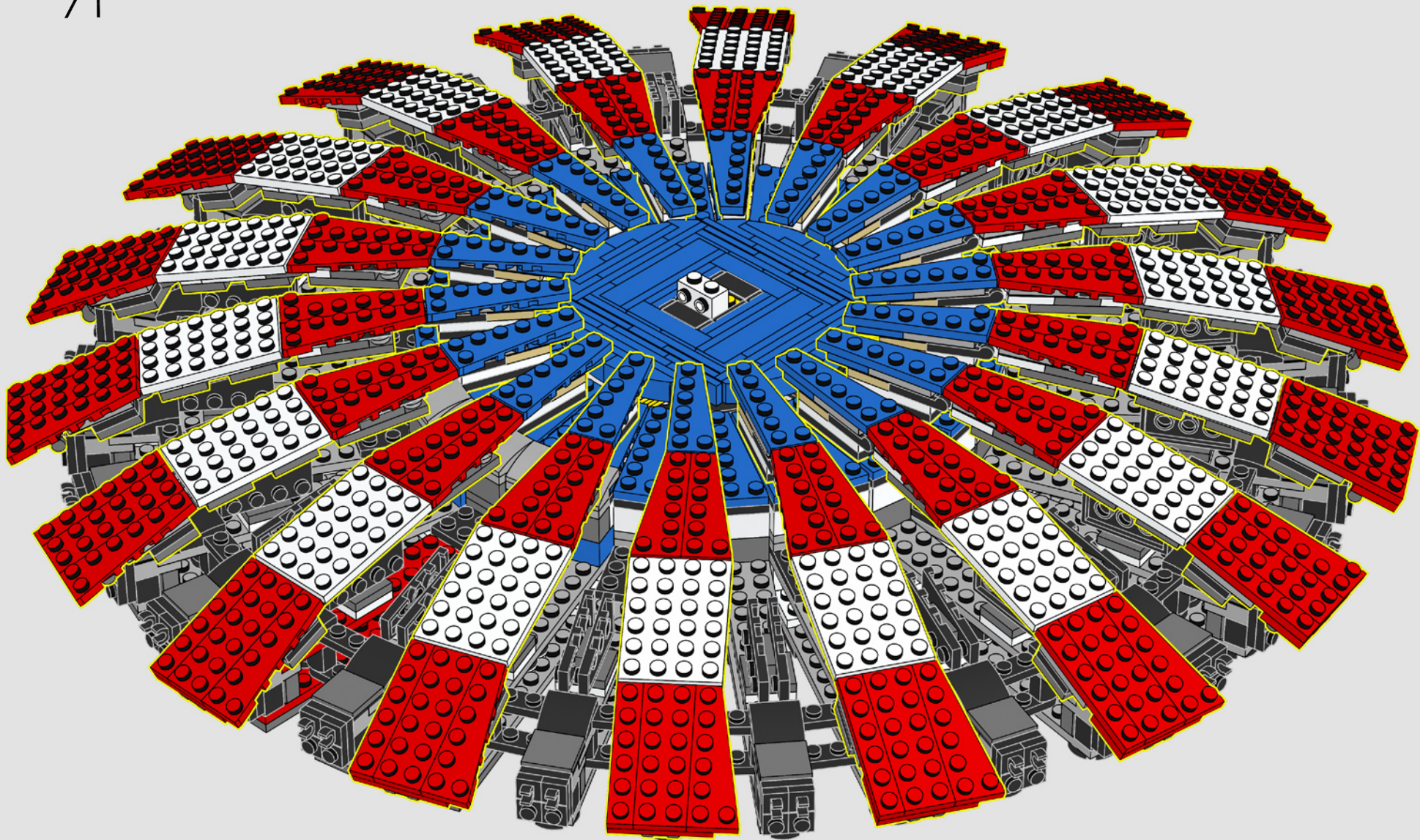

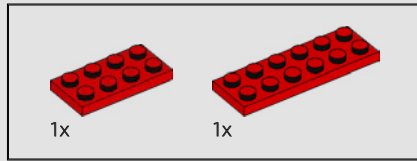
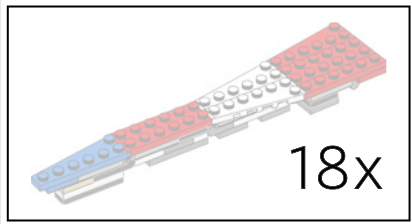

72

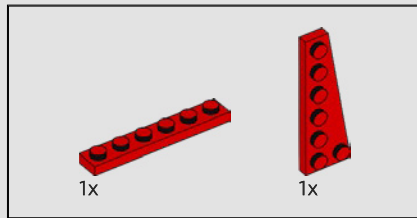
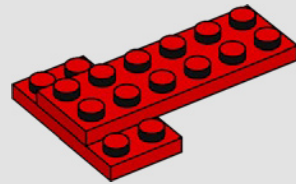

73

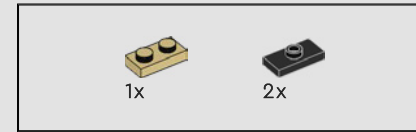
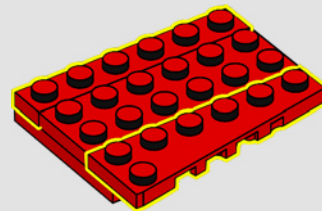

74

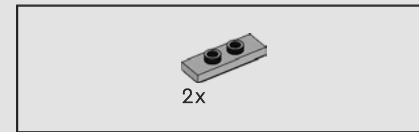
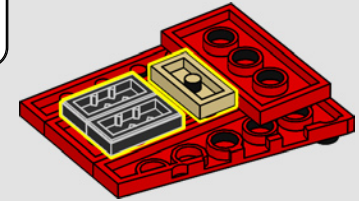
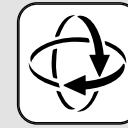

75

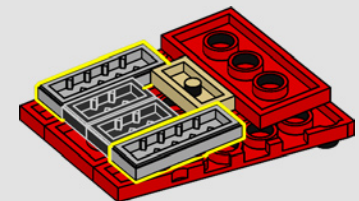

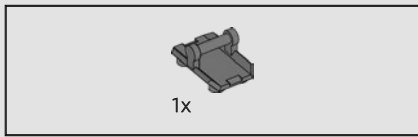

76

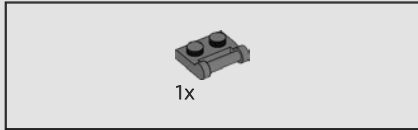
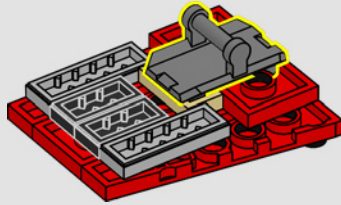

77

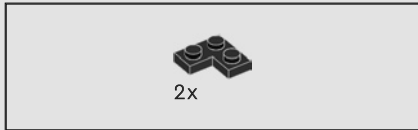
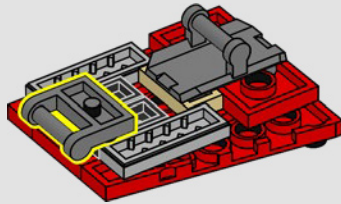

78

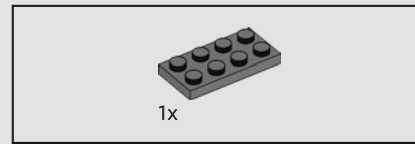
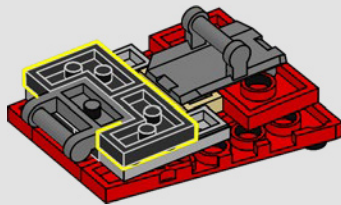

79

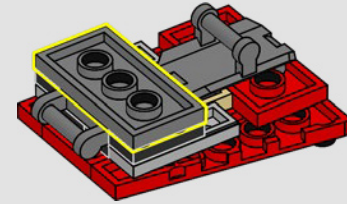

80

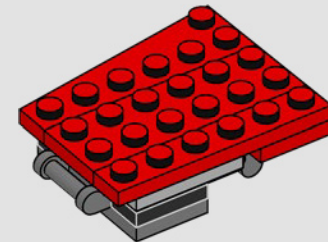
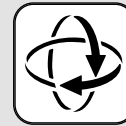

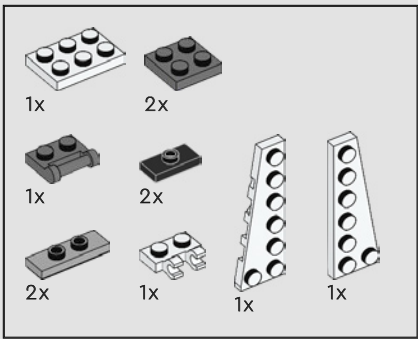

81

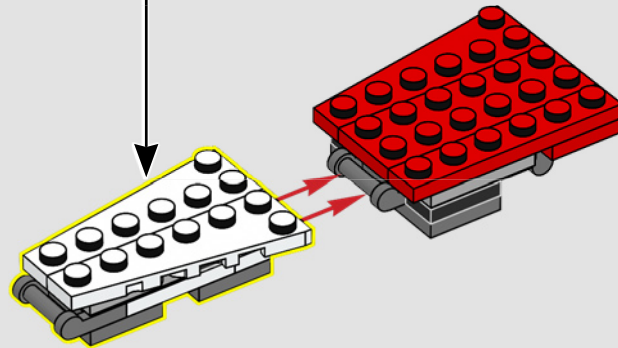
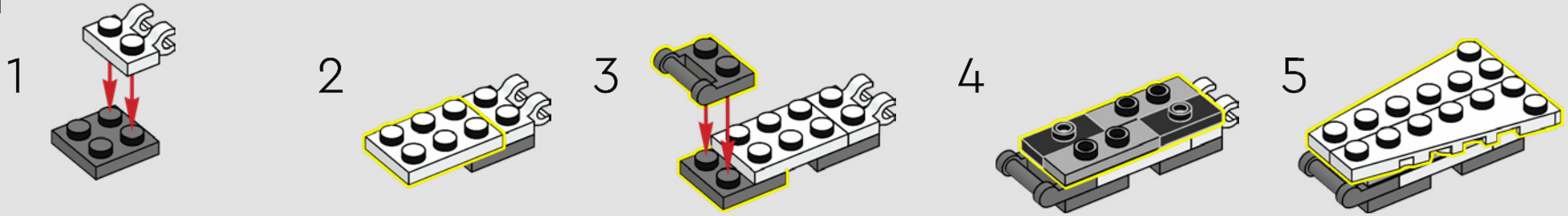

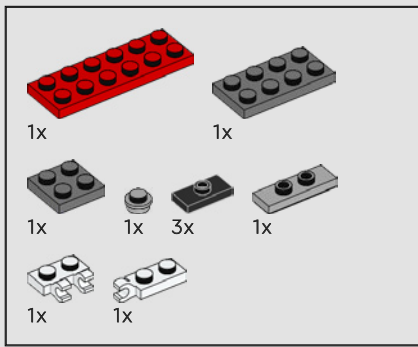

82

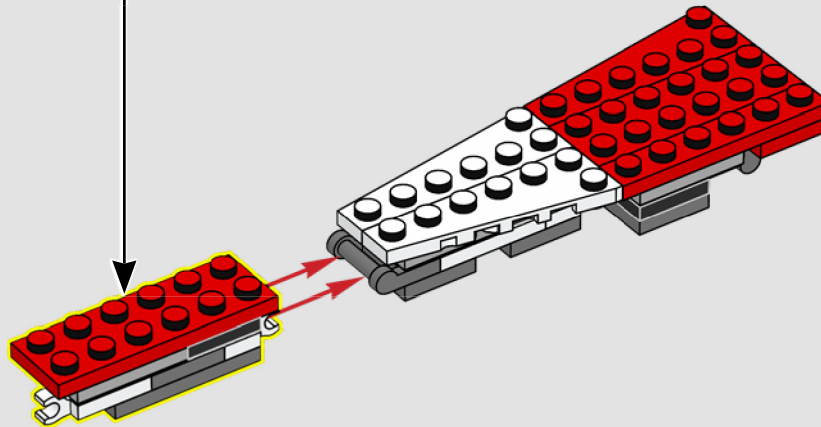
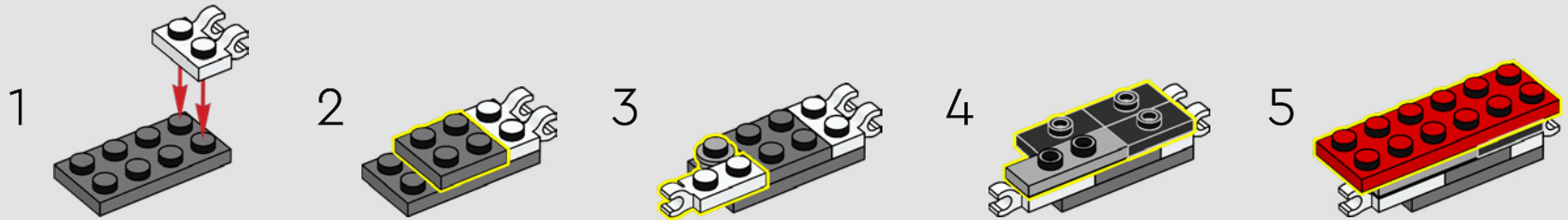

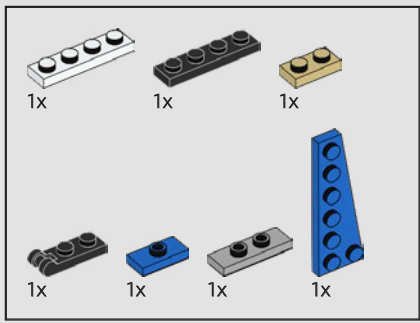

83

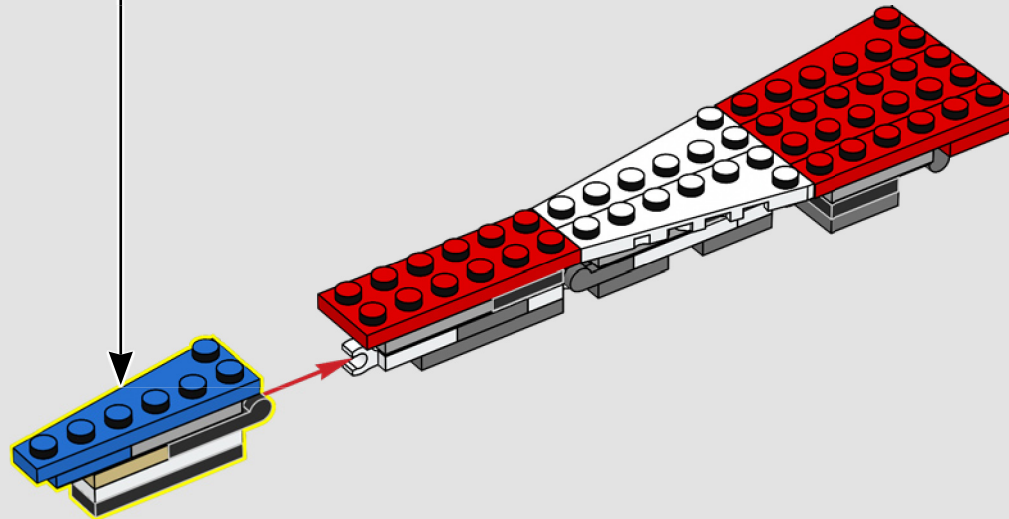
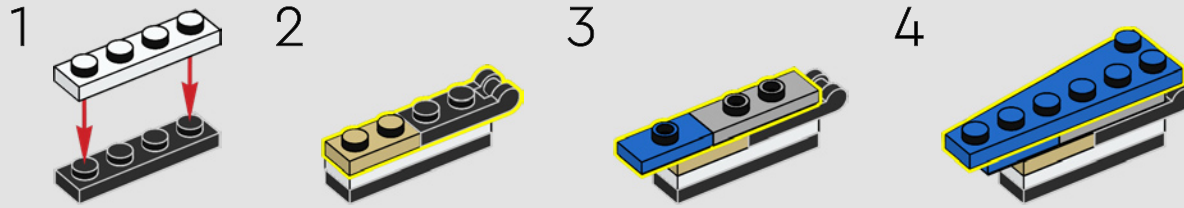

18x

84

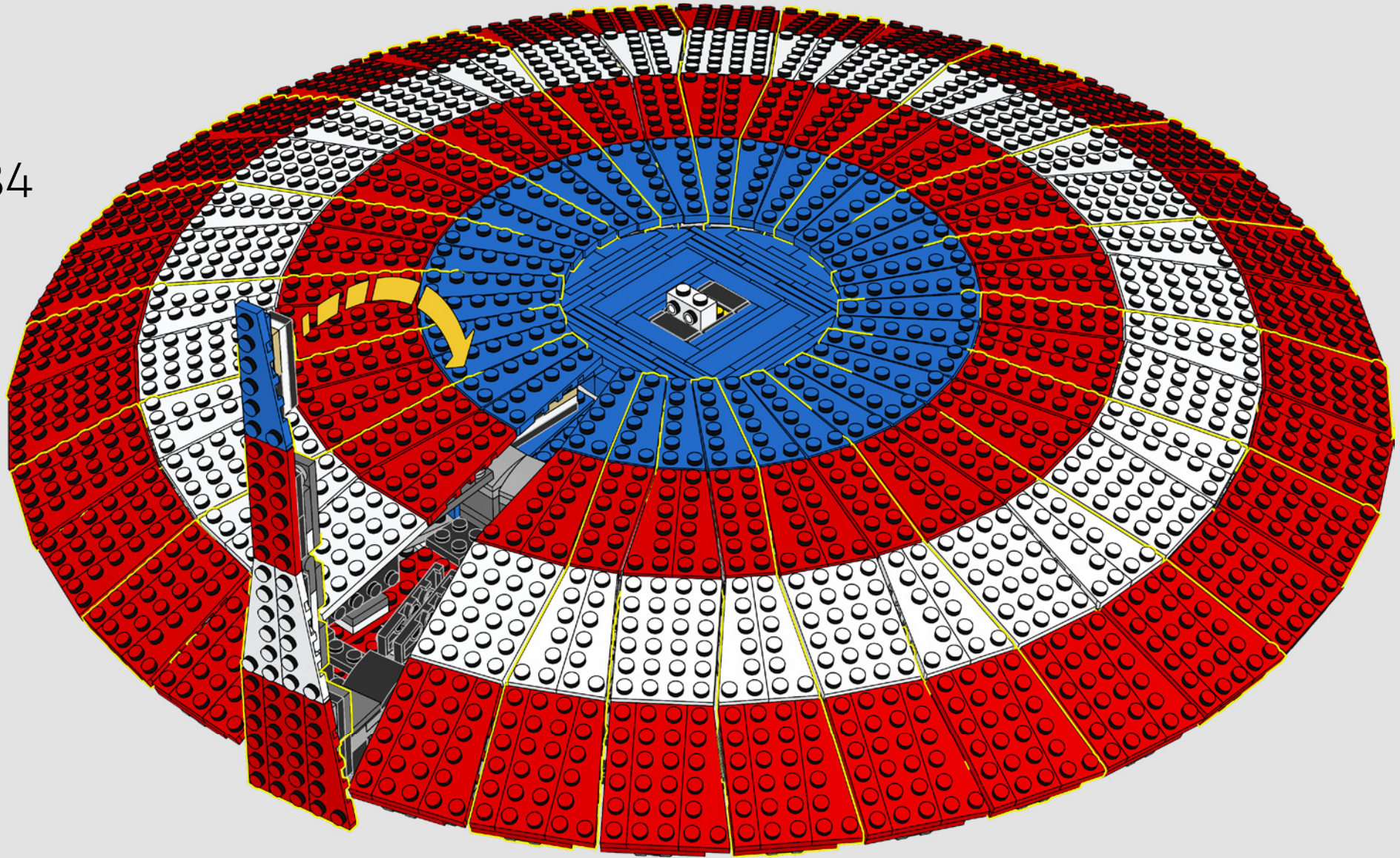

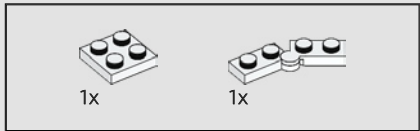
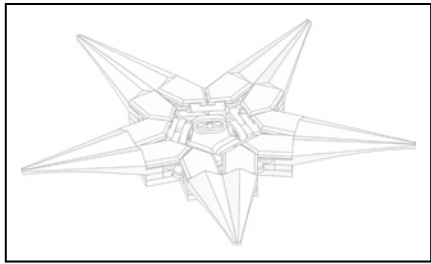

85

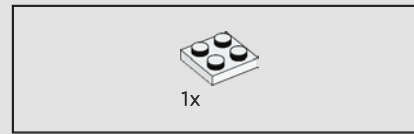
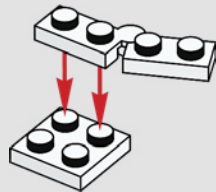

86

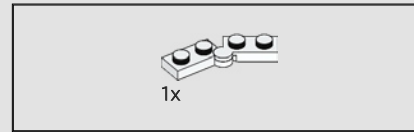
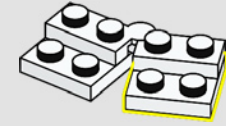

87

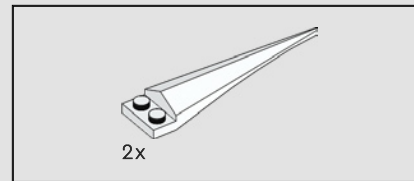
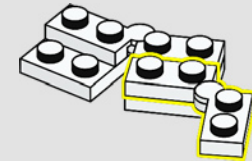

88

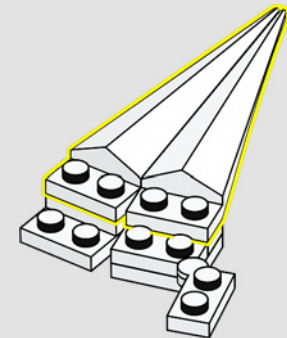

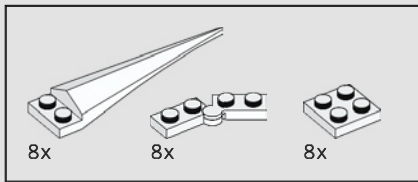

89

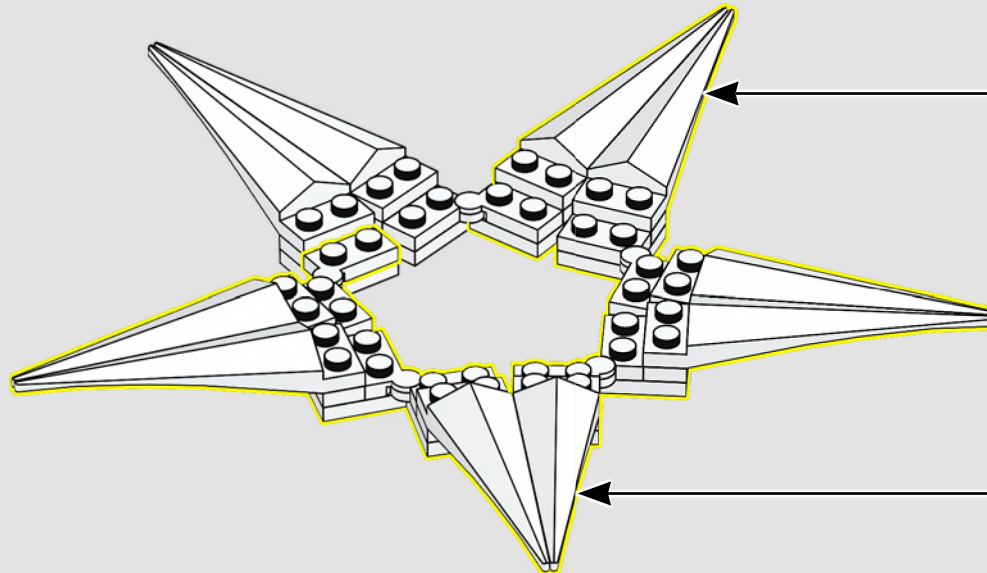
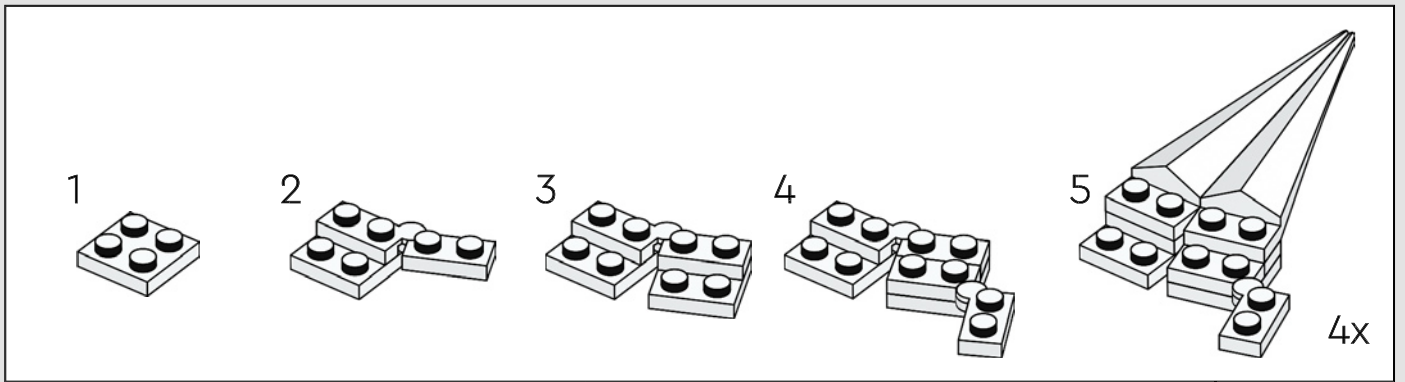

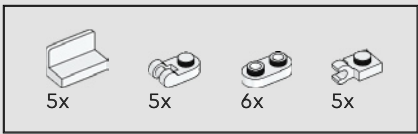

90

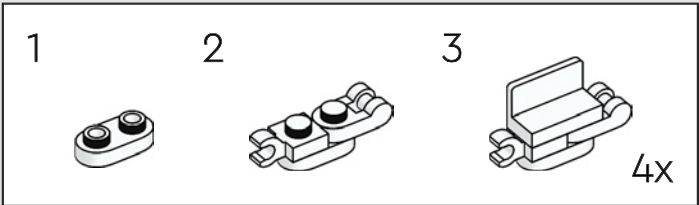

1



2

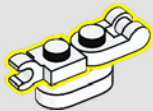

3

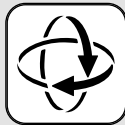
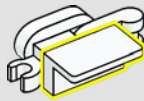

4

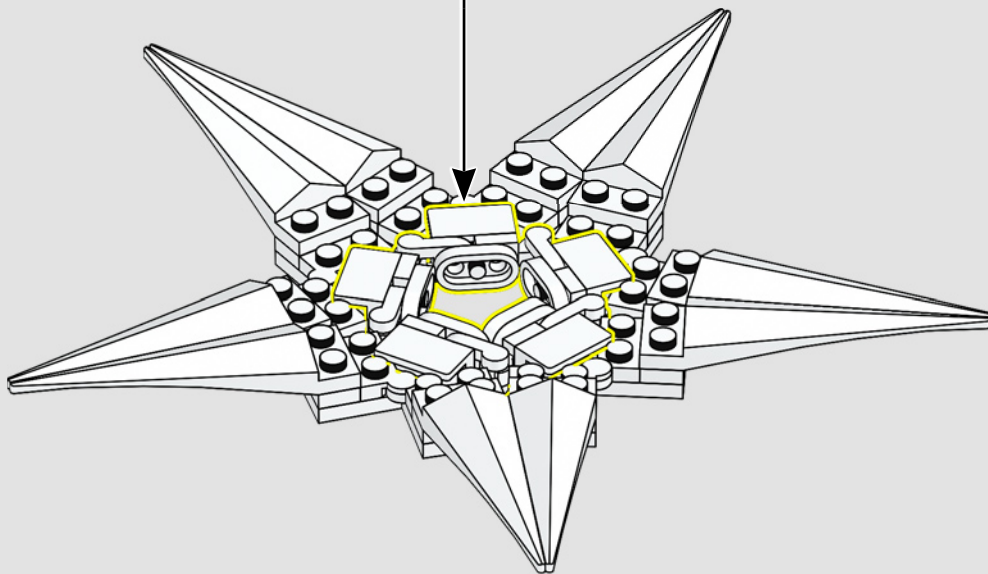
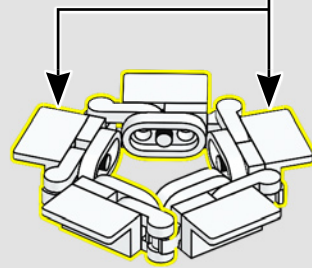



91

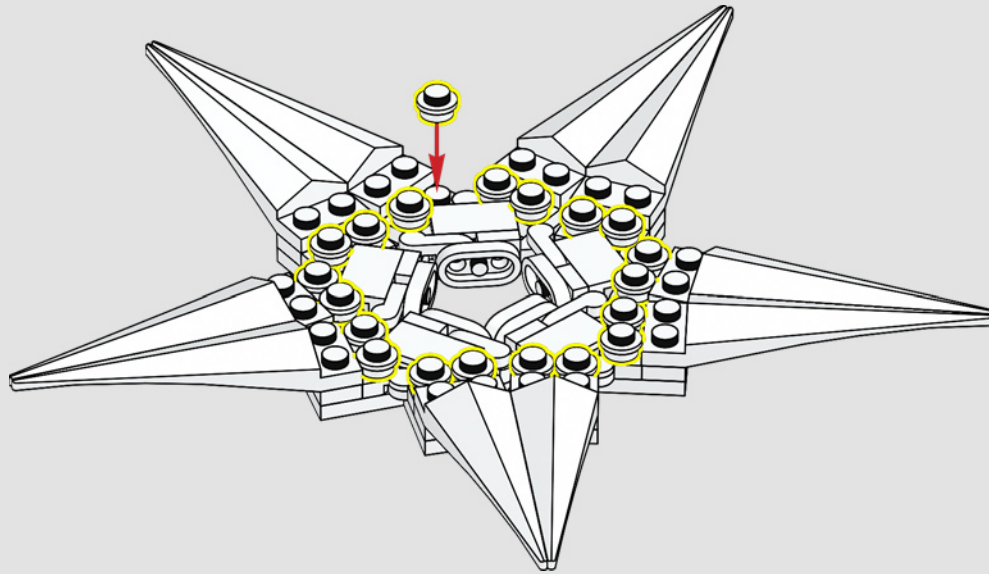

92

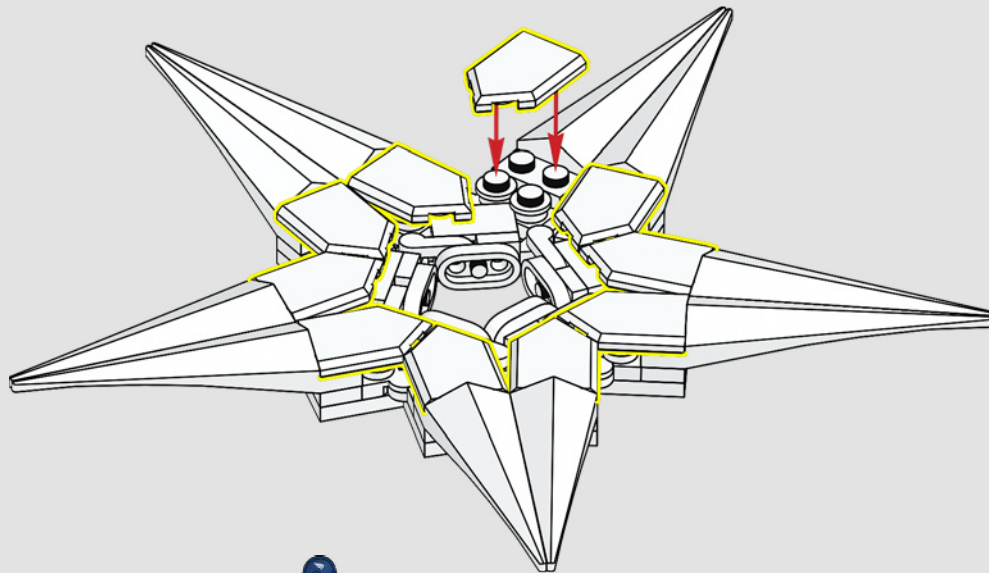

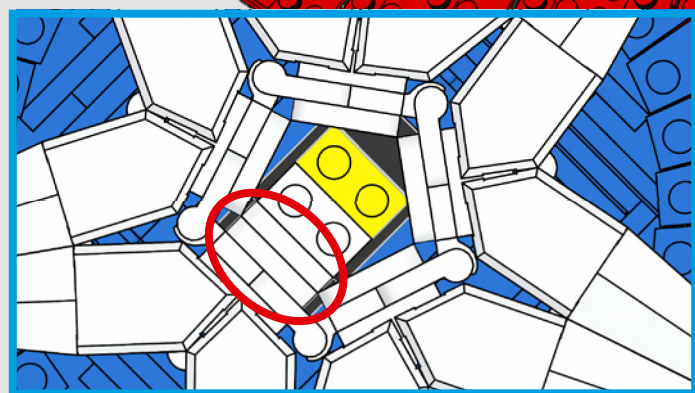
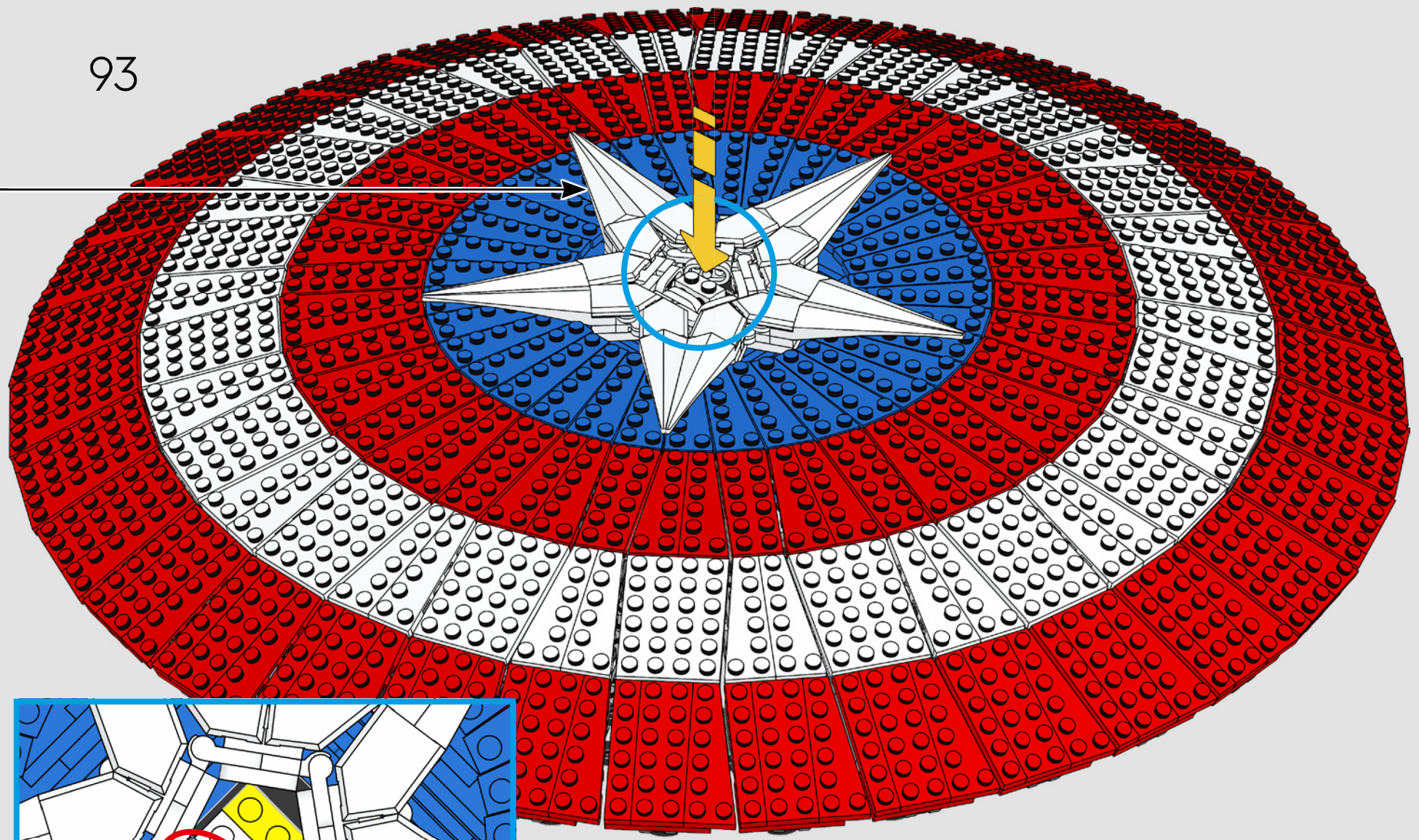

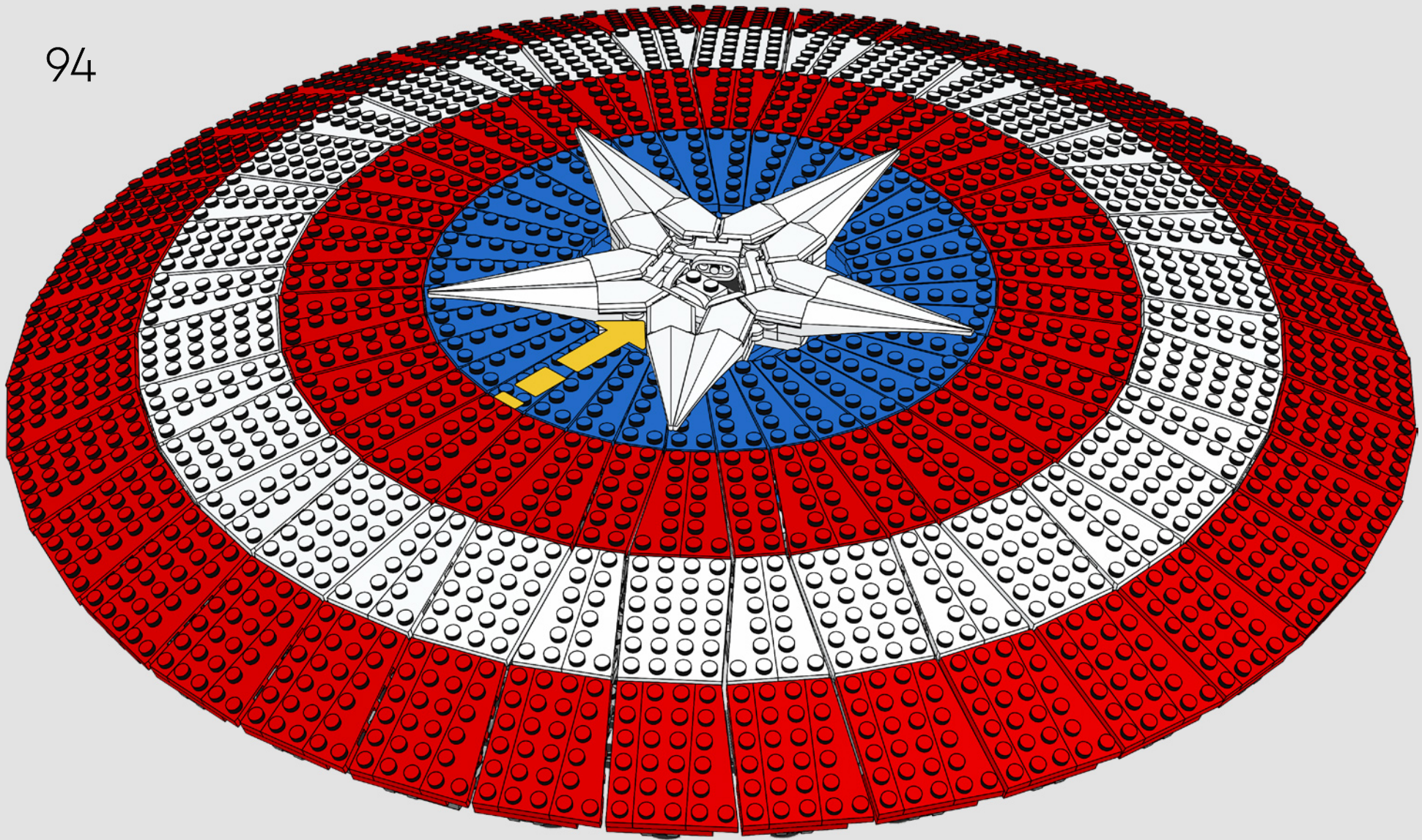



1x

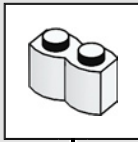

95

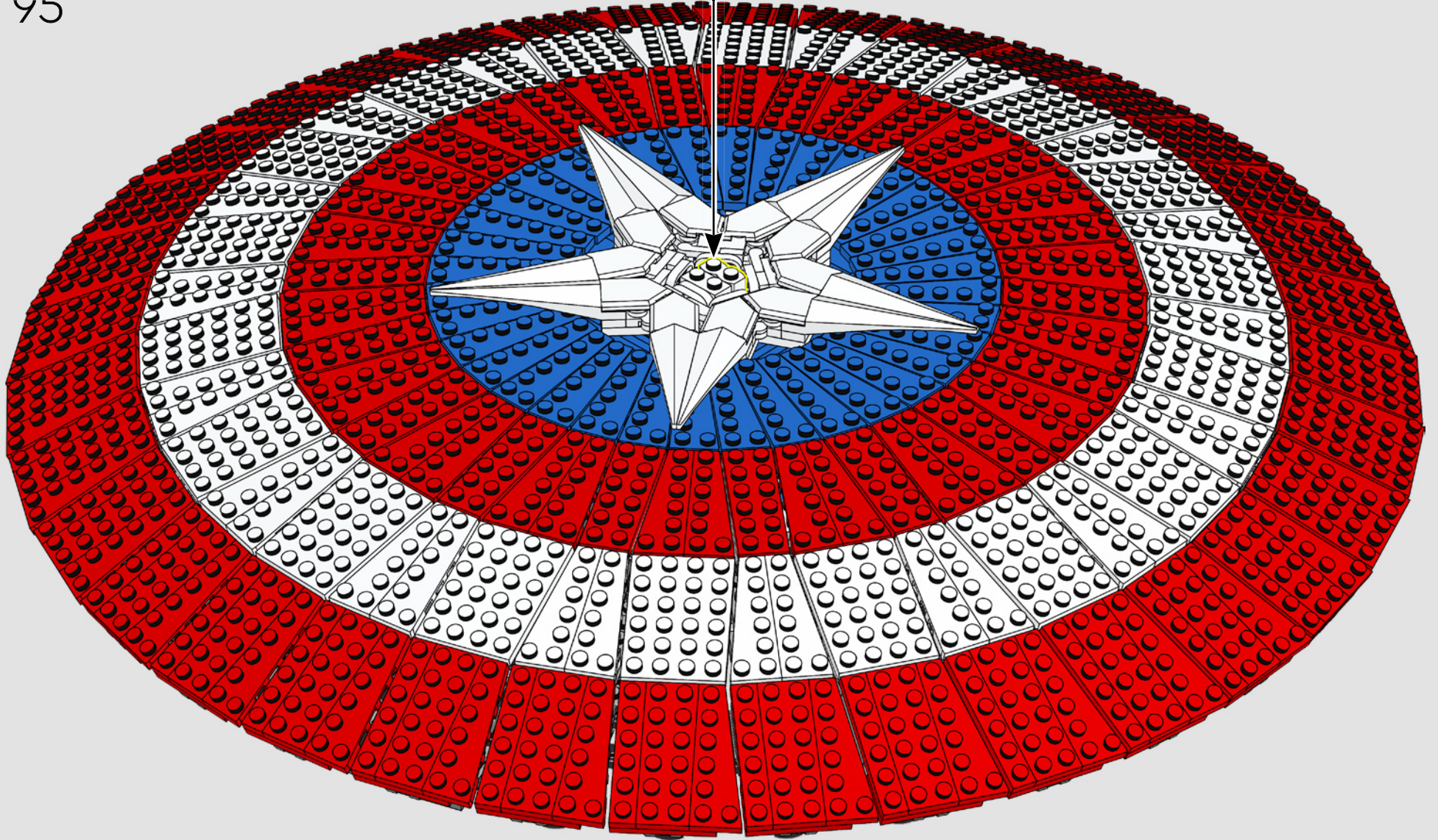

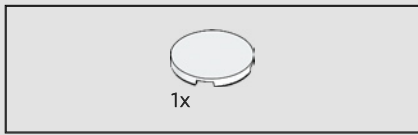

96

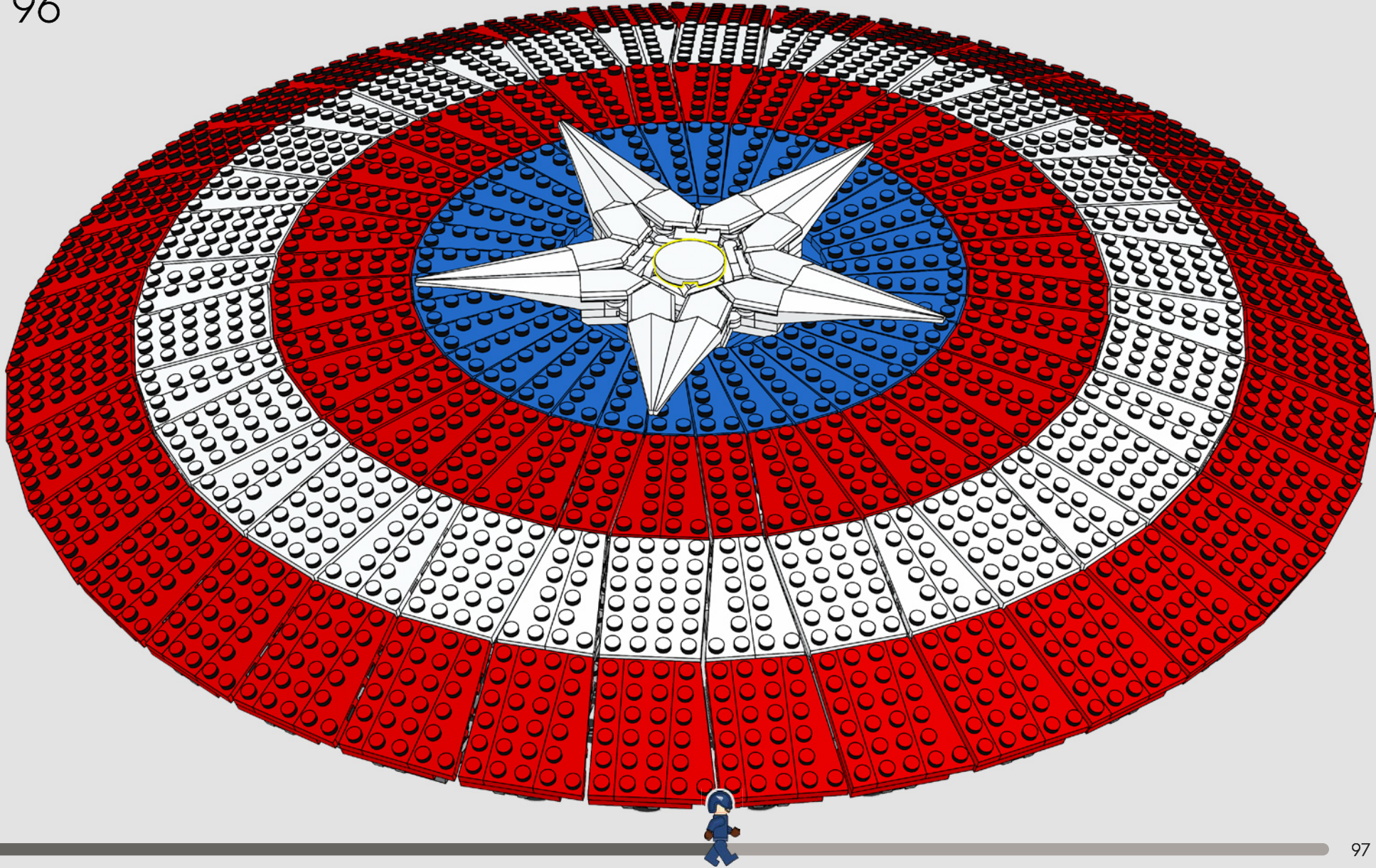

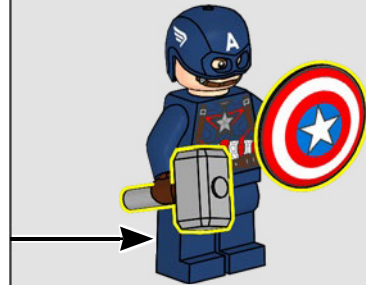
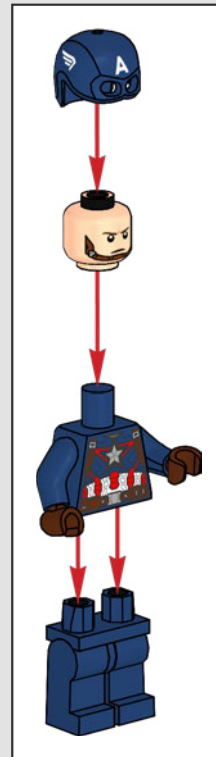
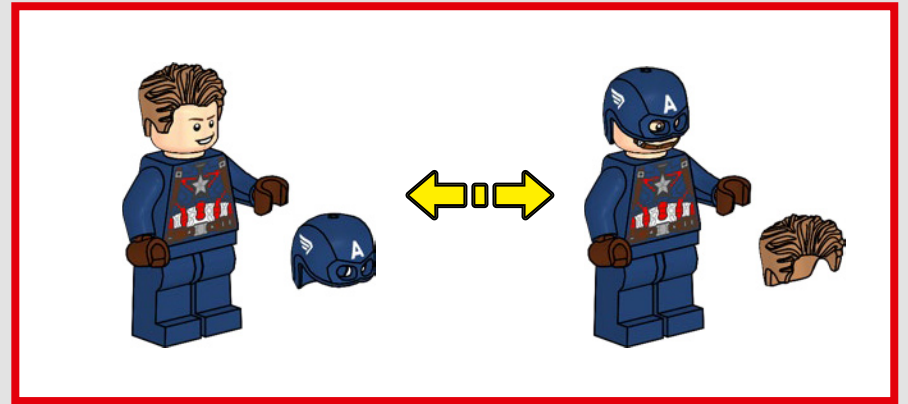

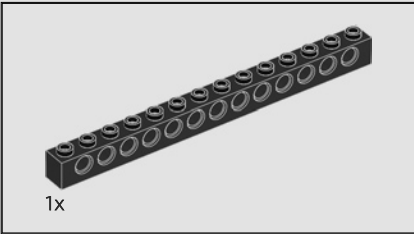
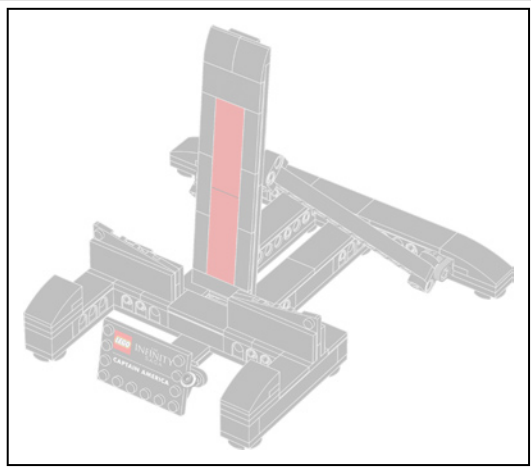

97

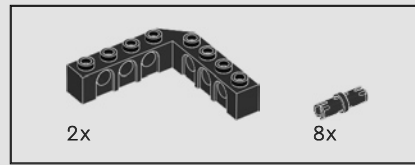
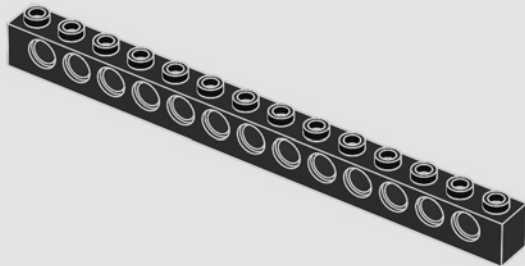

98

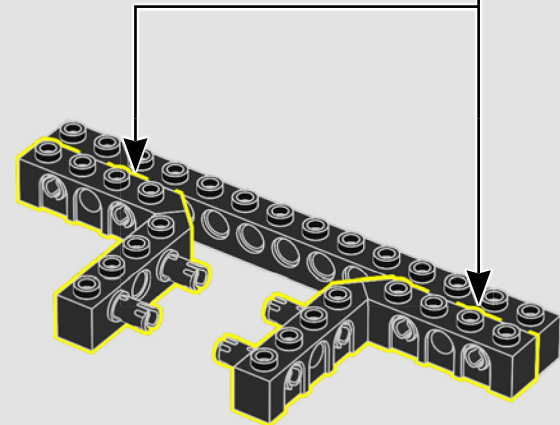
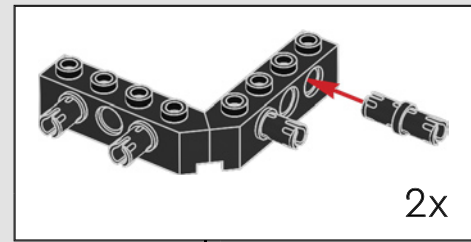

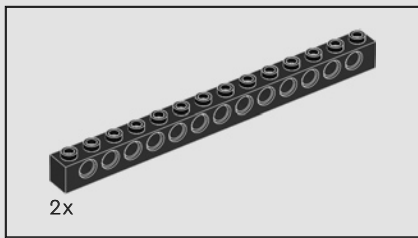

99

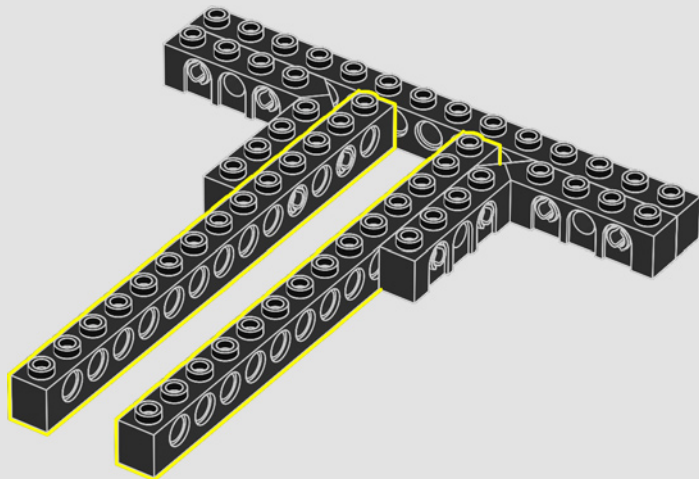

100

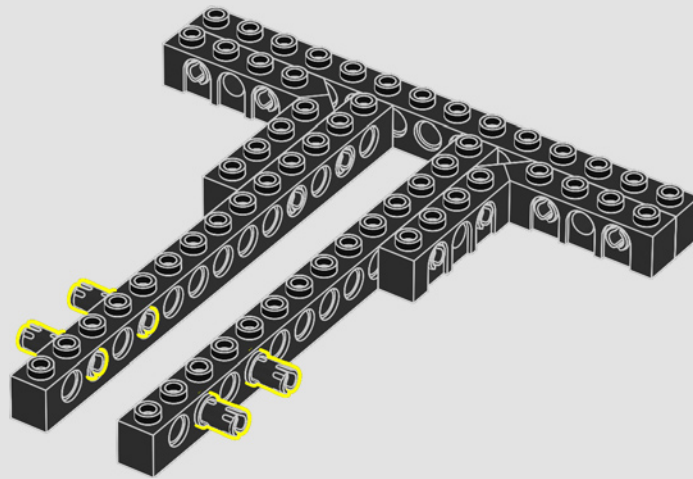

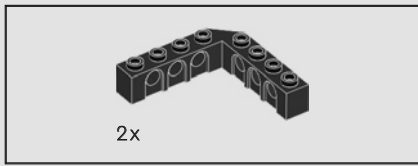

101

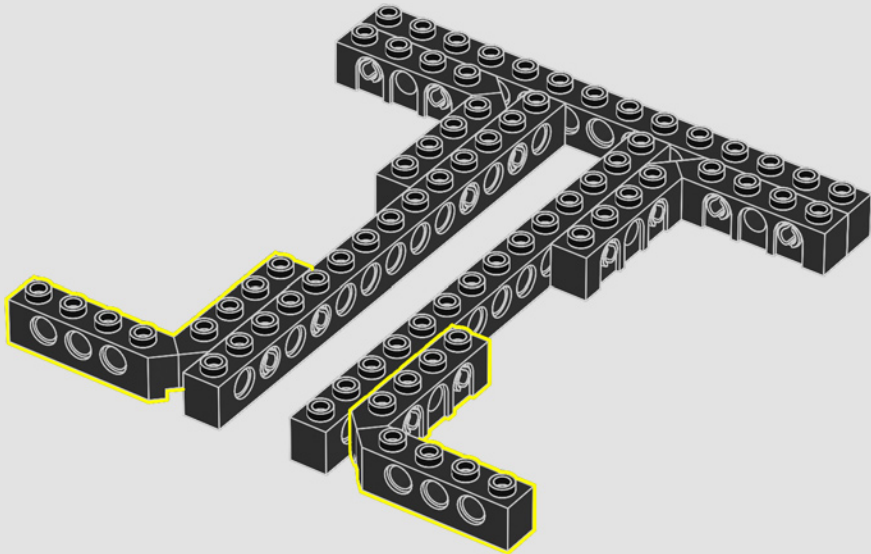

102

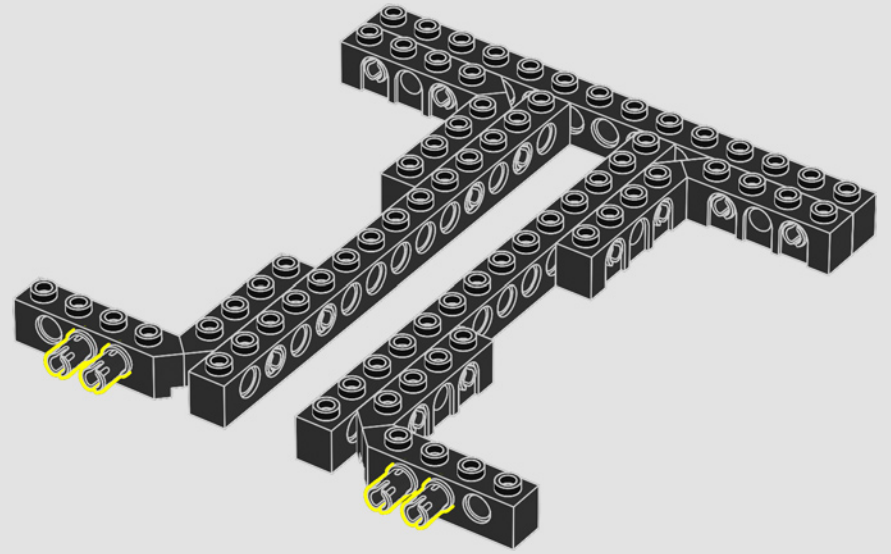

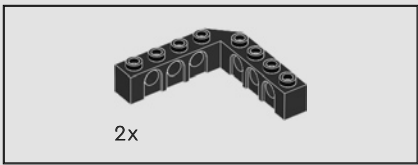

103

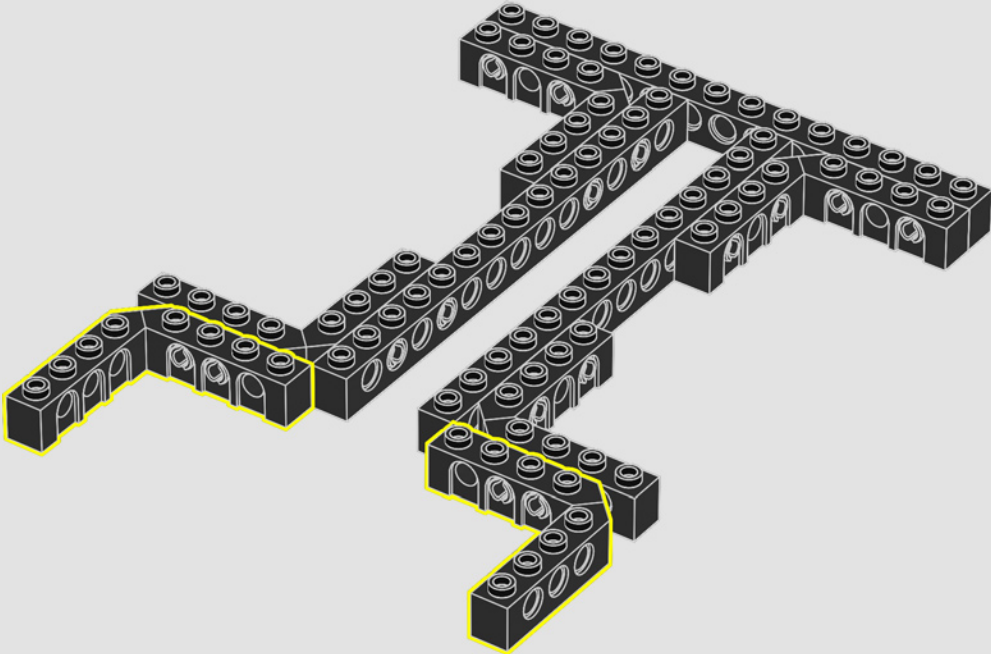

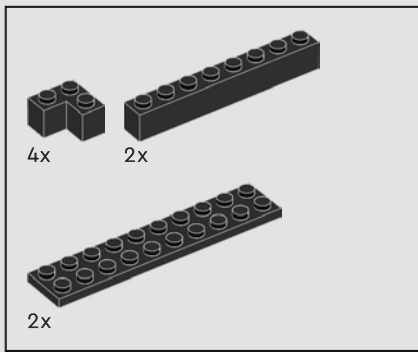

104

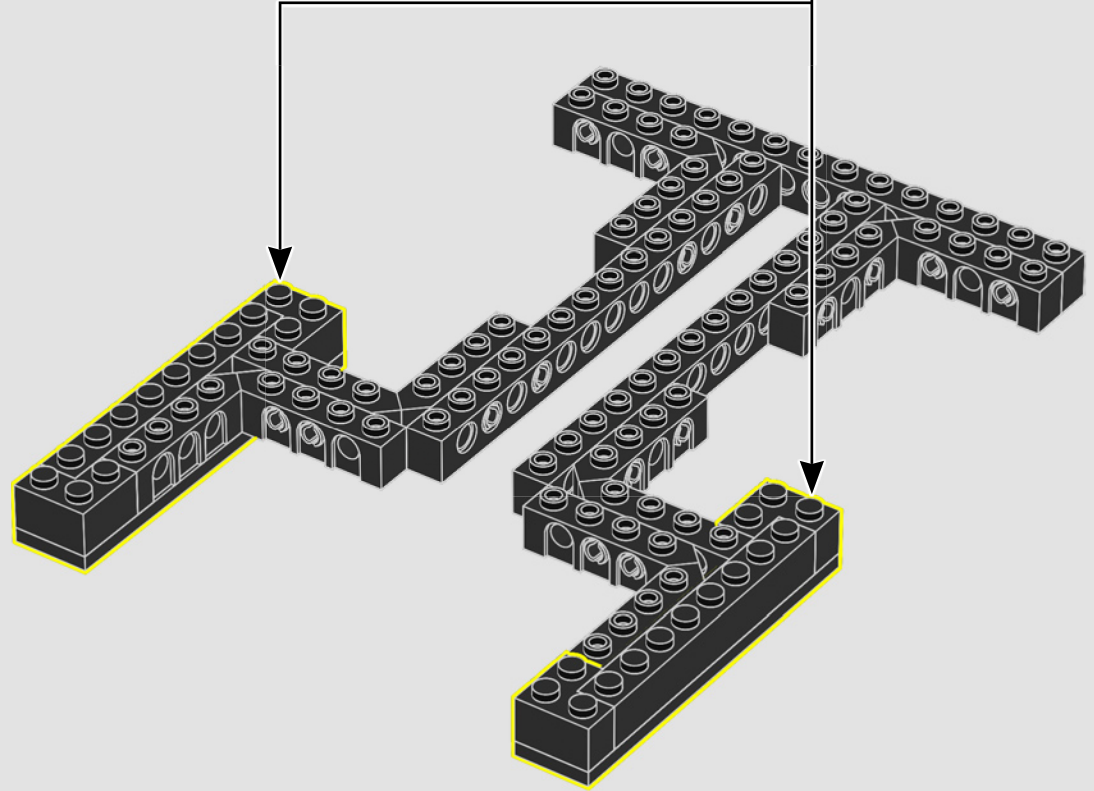
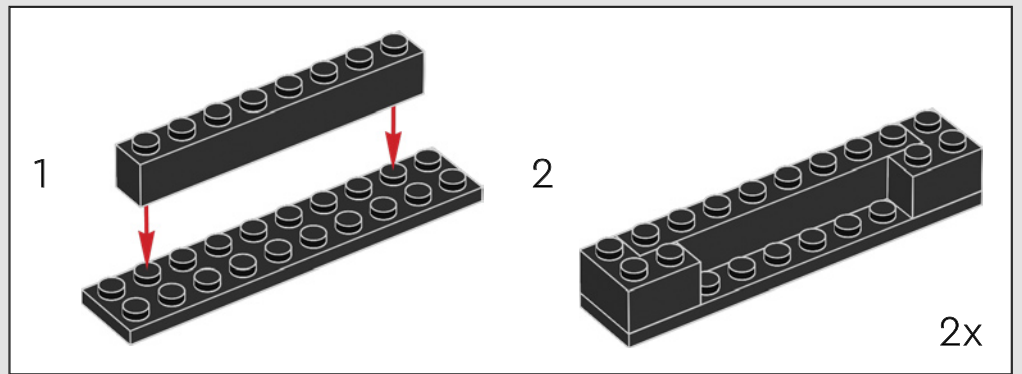
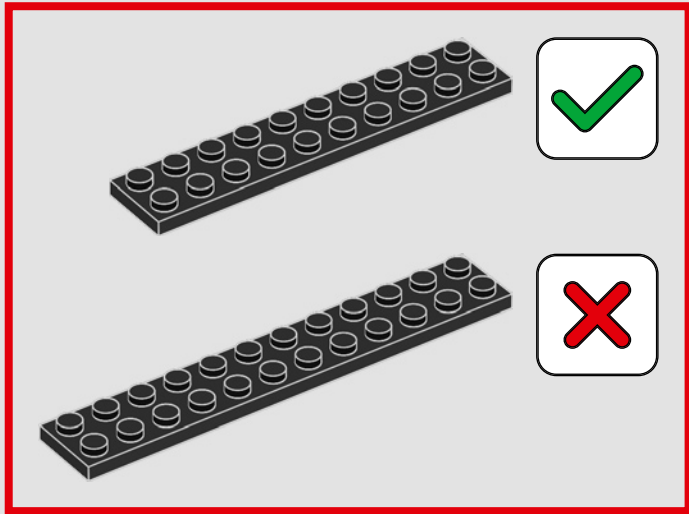

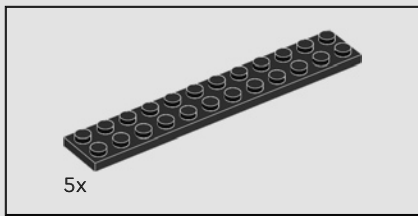

105

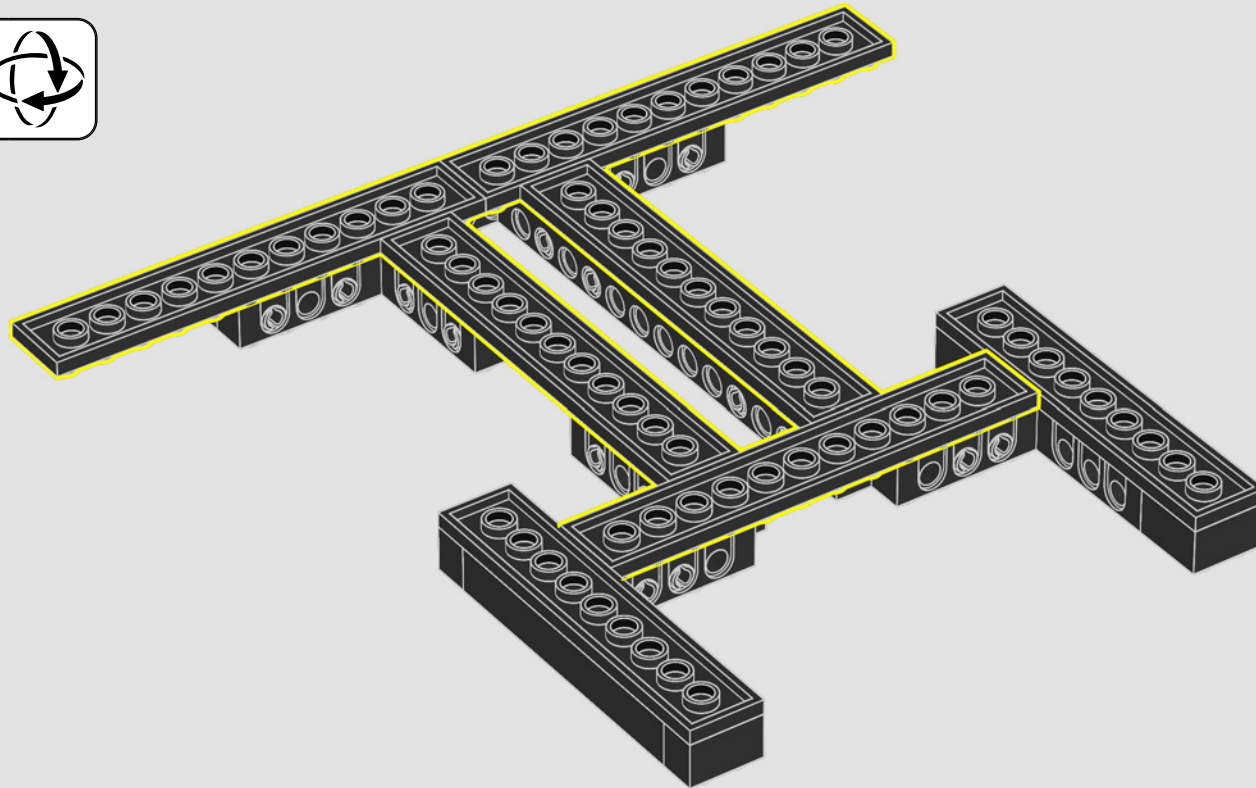

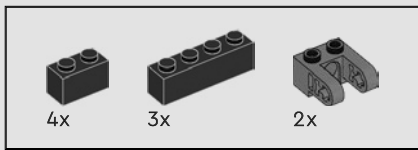

106

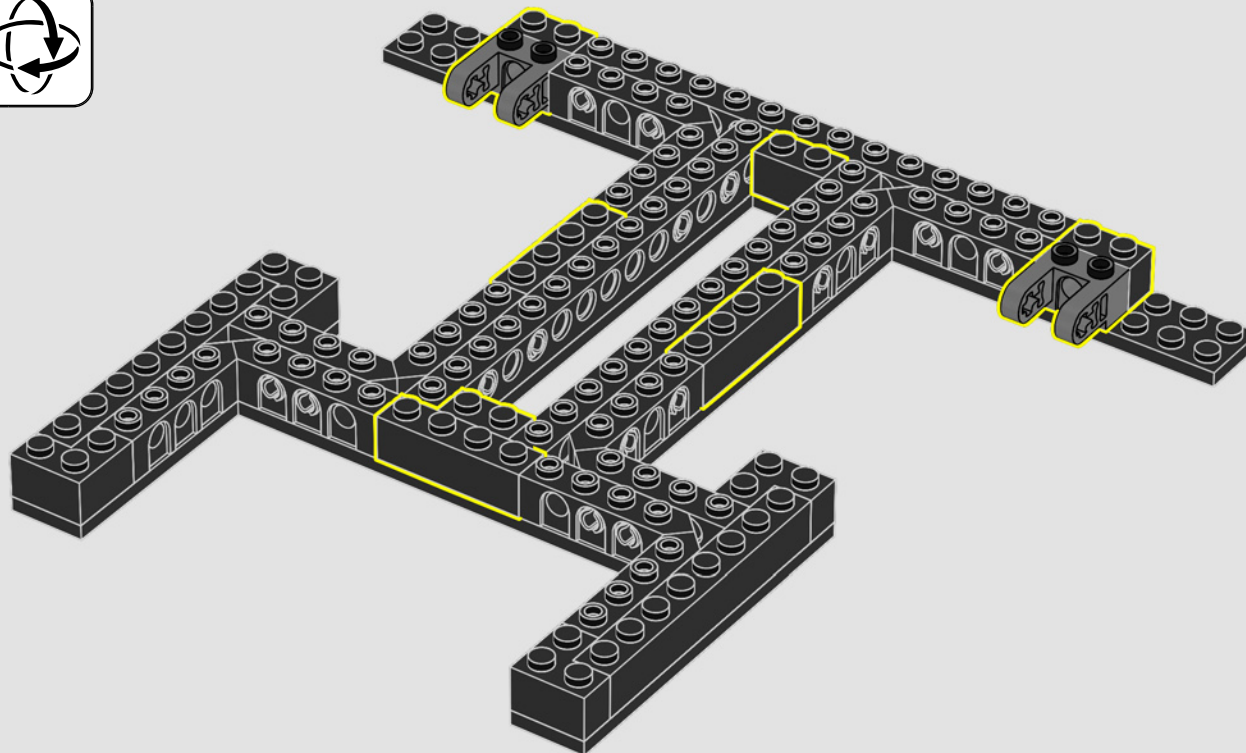

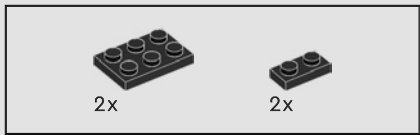

107

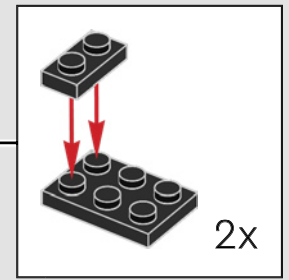
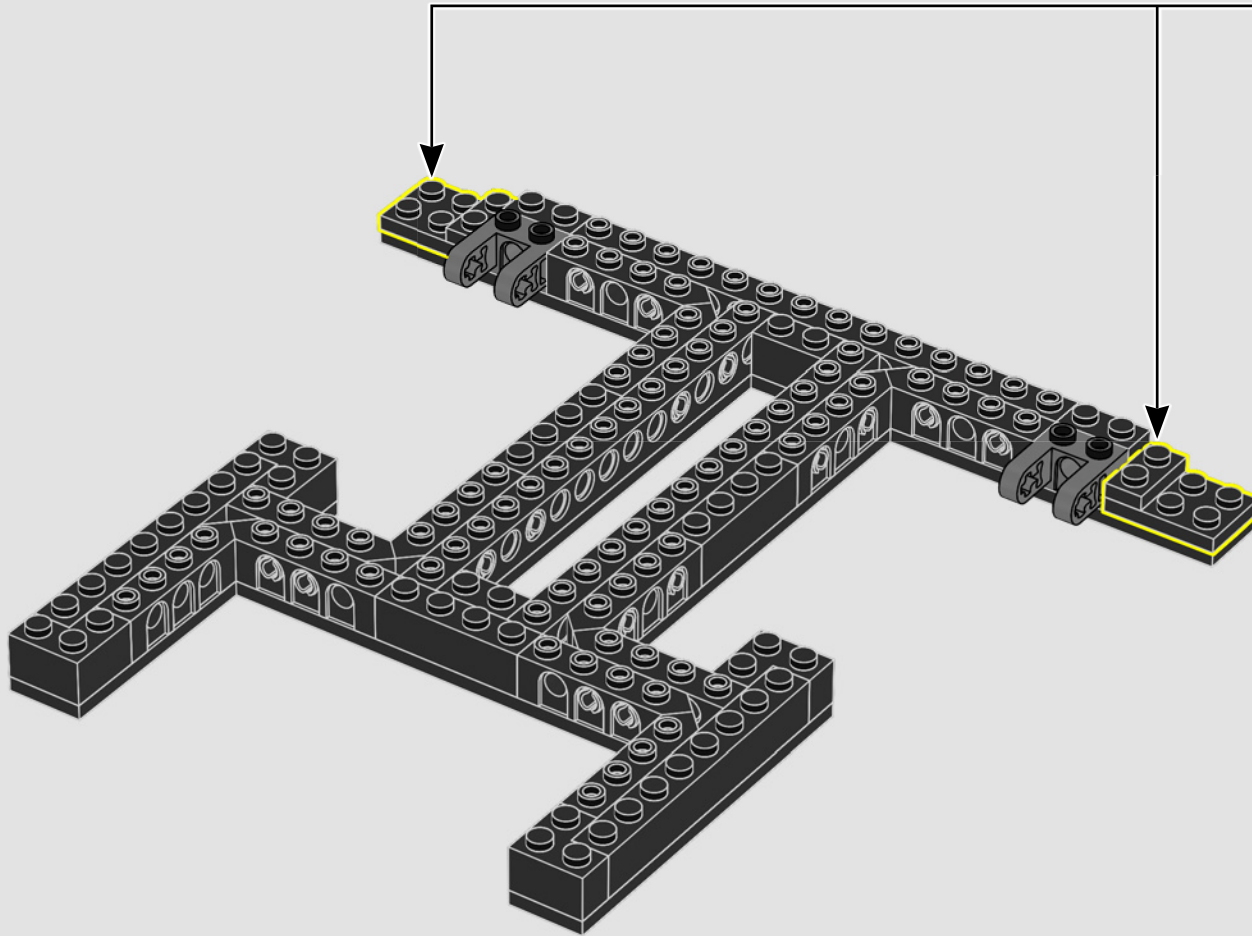



108

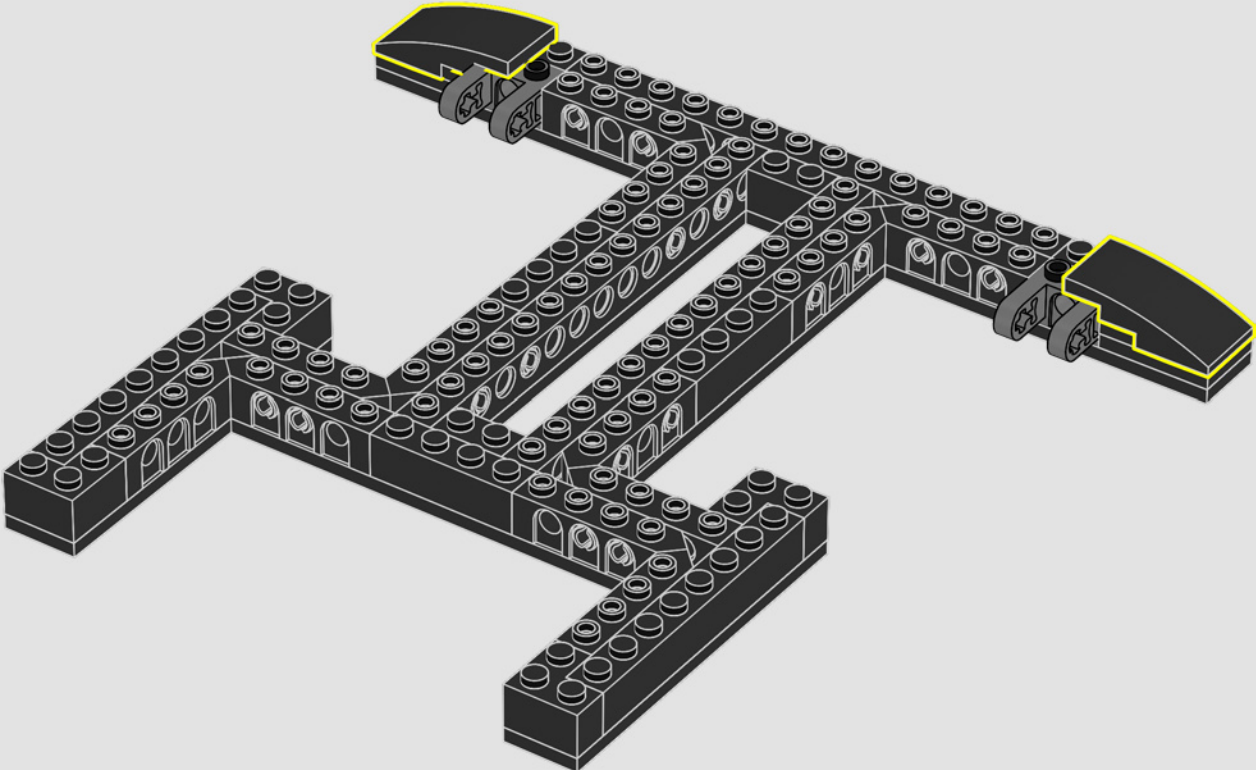

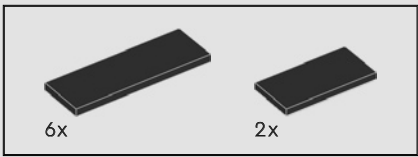

109

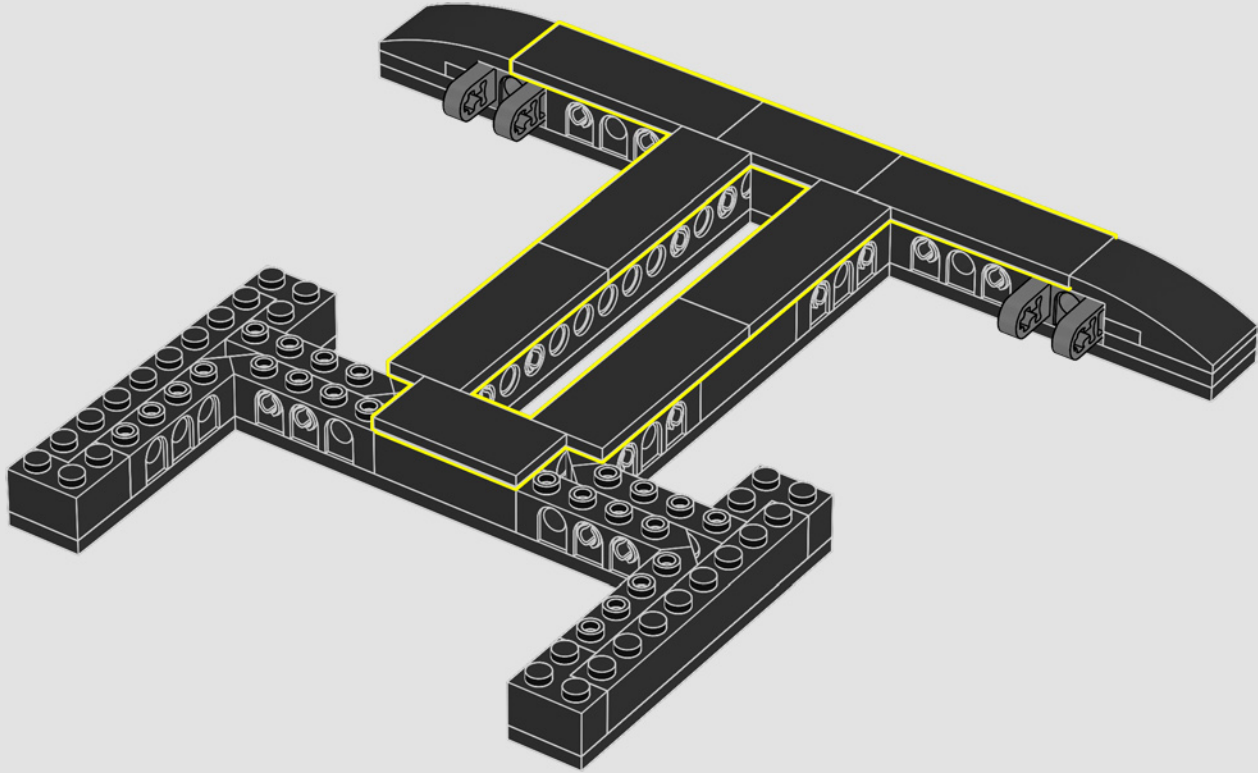

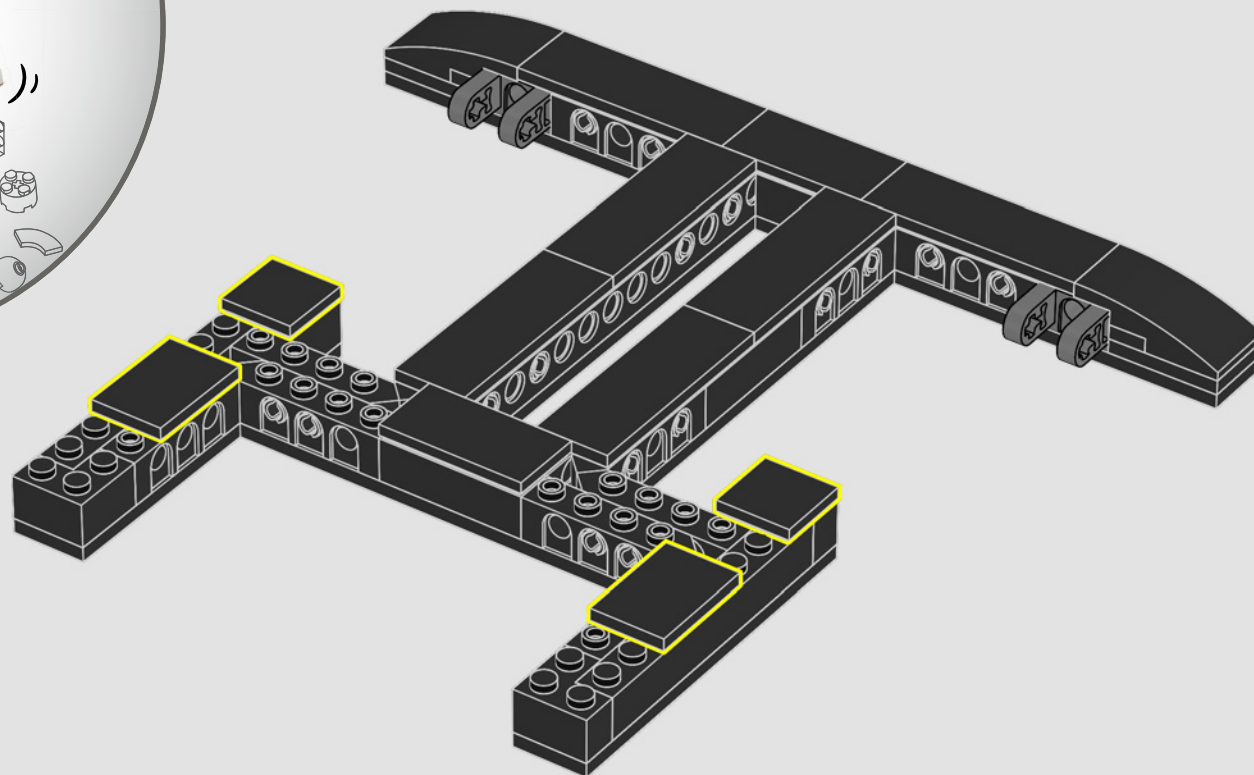
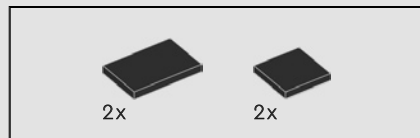

110





10x

111

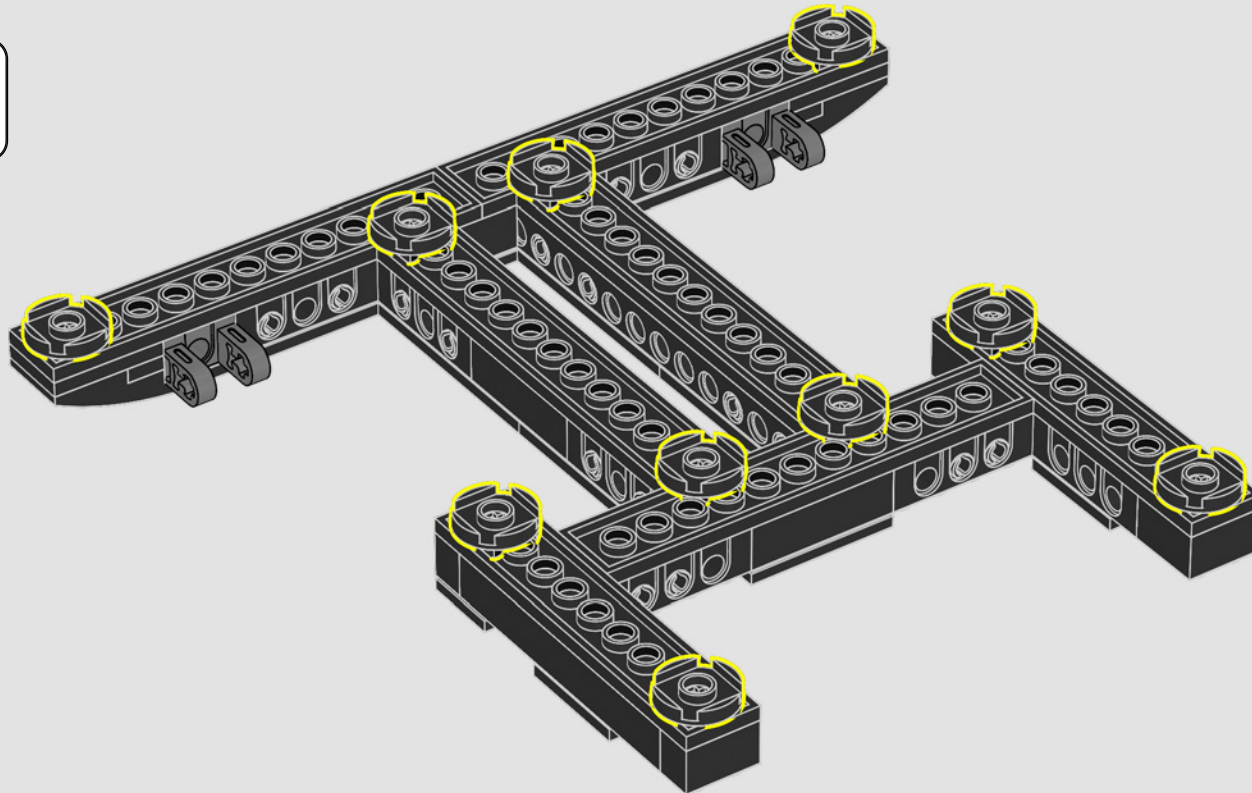

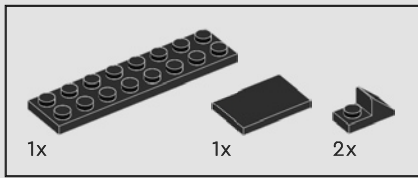

112

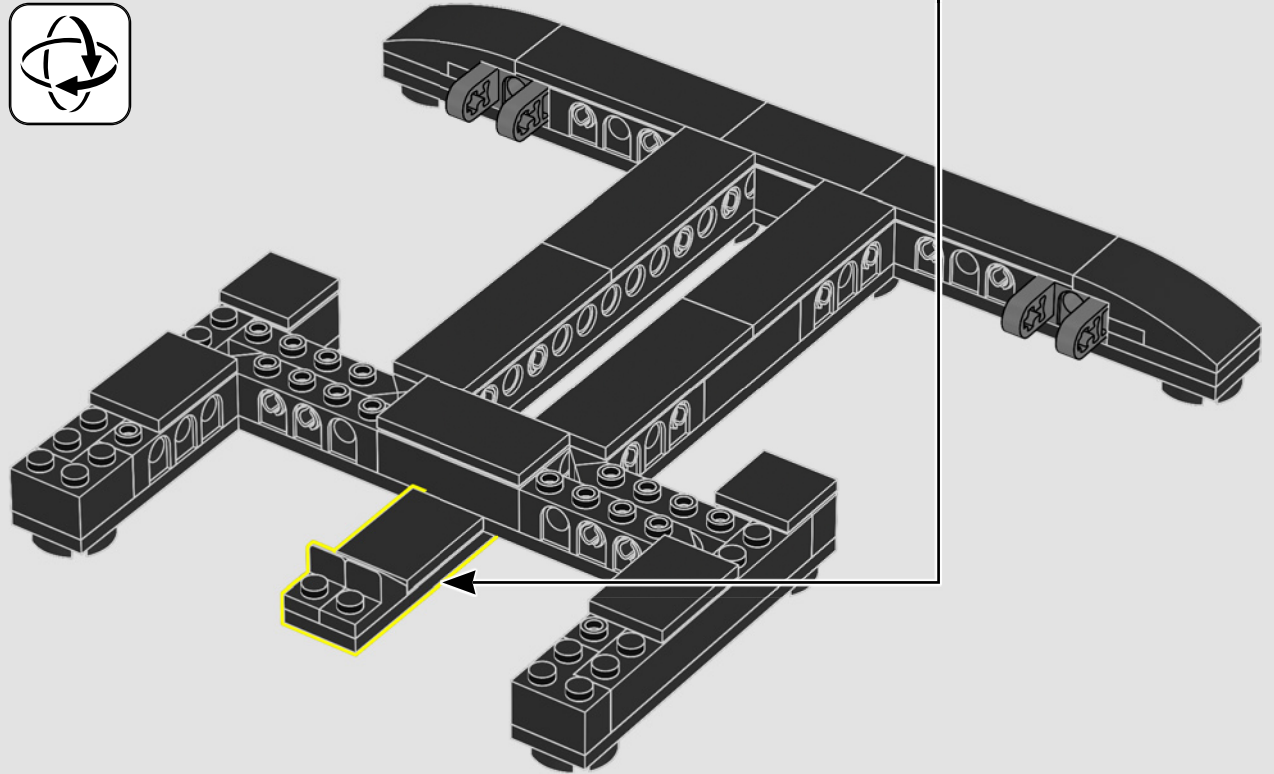
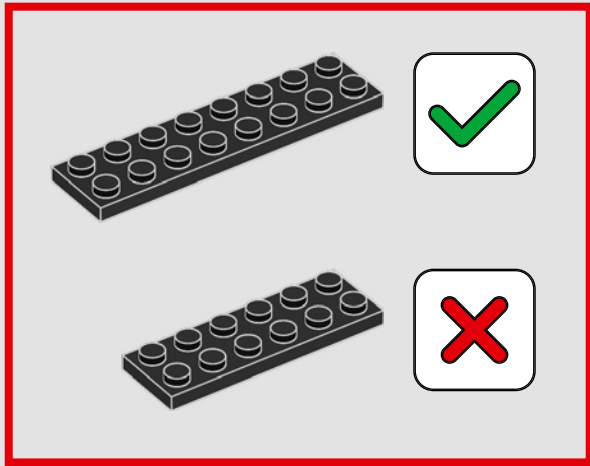
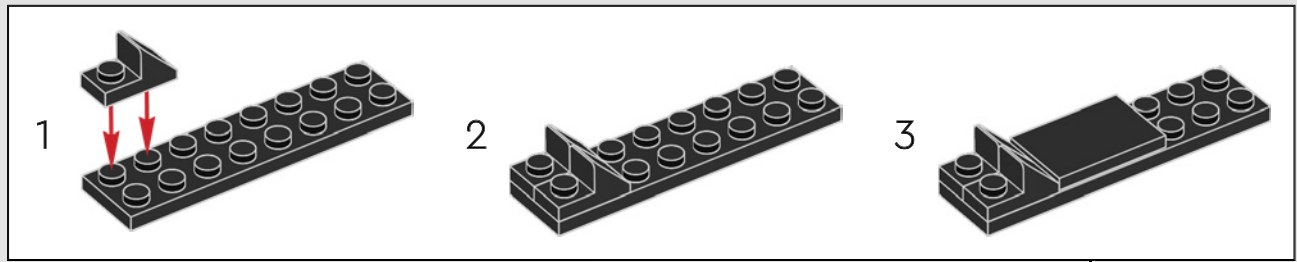

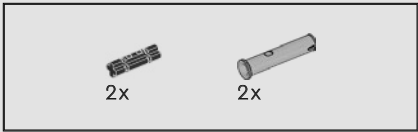

113

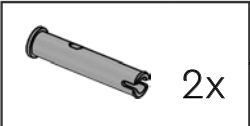
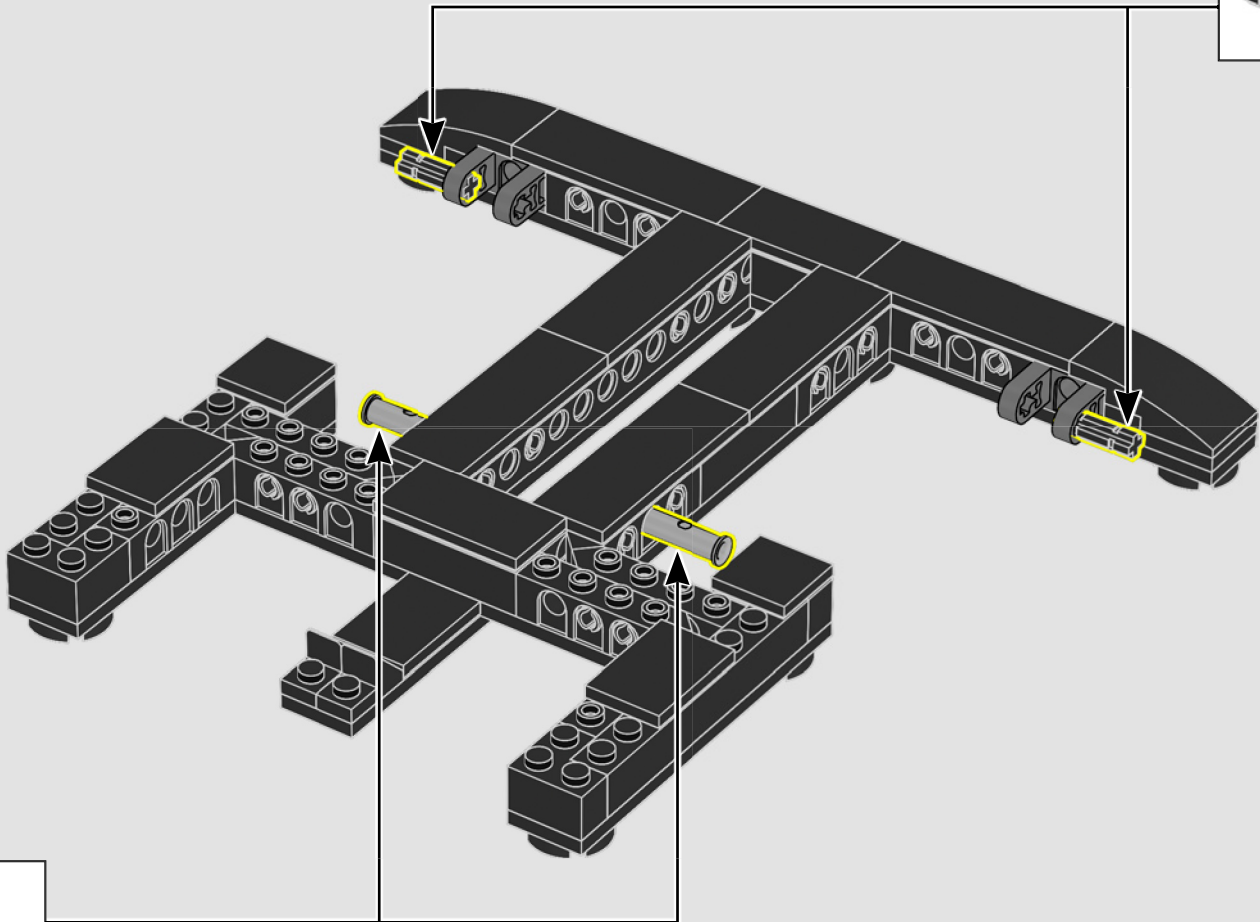

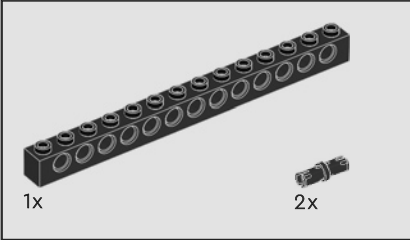
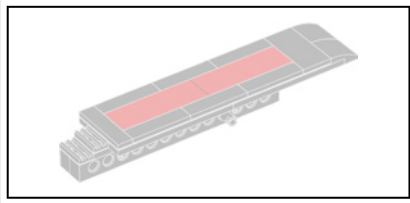

114

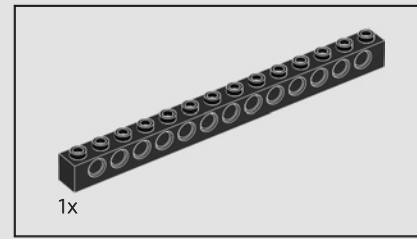
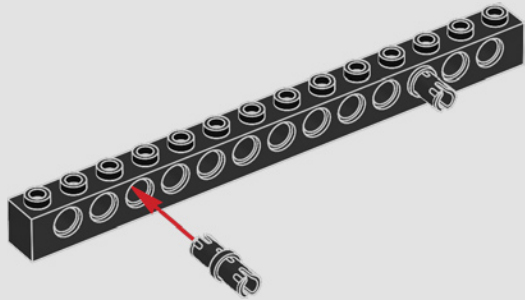

115

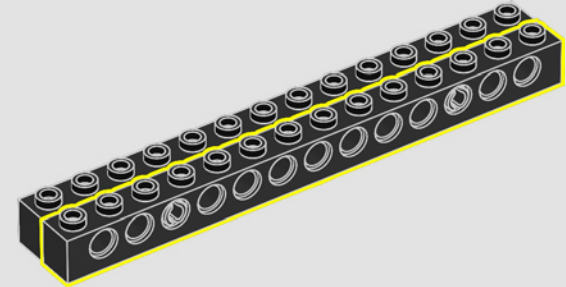

116

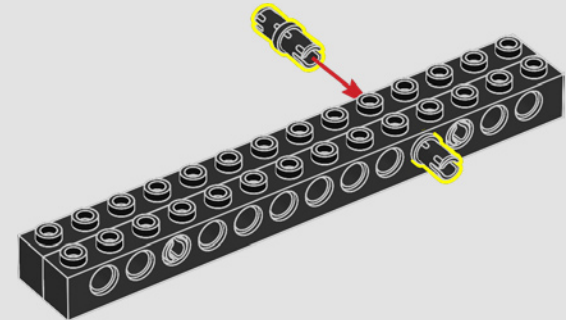



1x

117

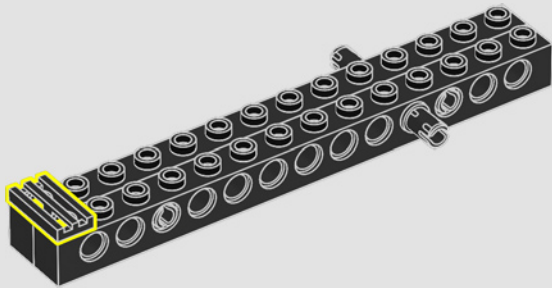

1x

1x

1x

118

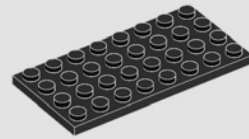
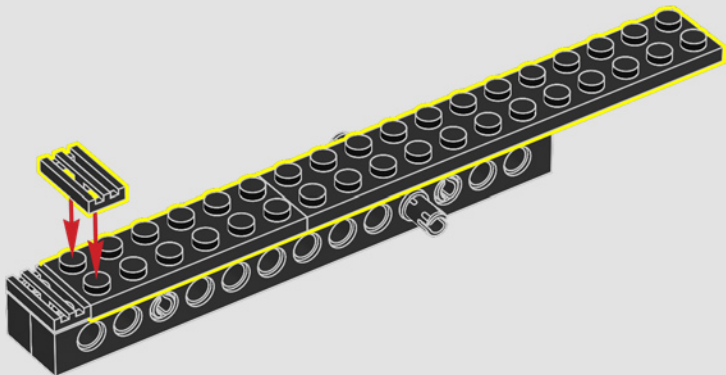

2x

119

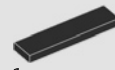
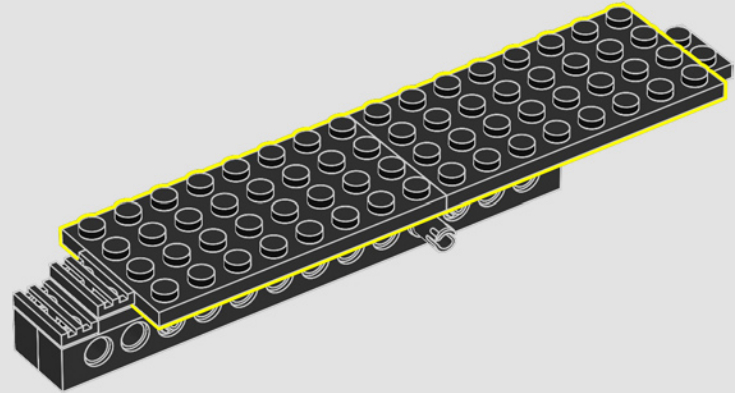

1x

120

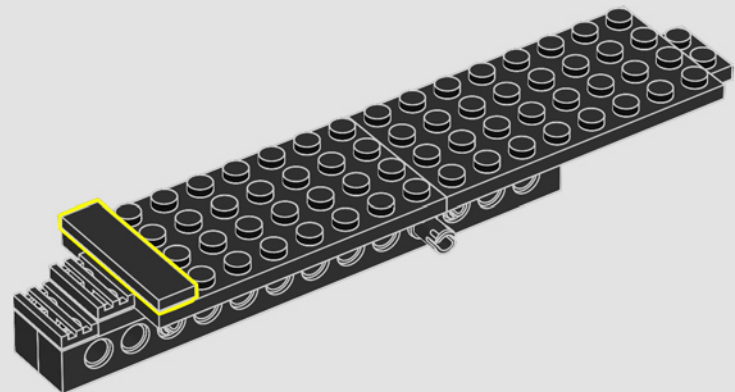

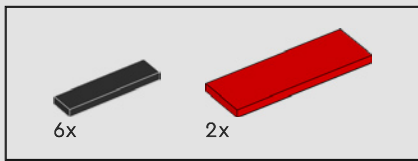

121

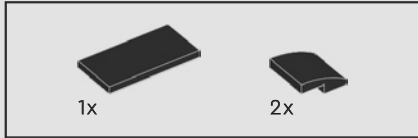
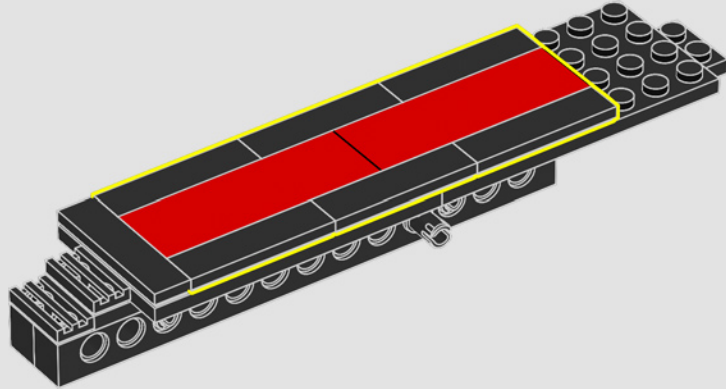

122

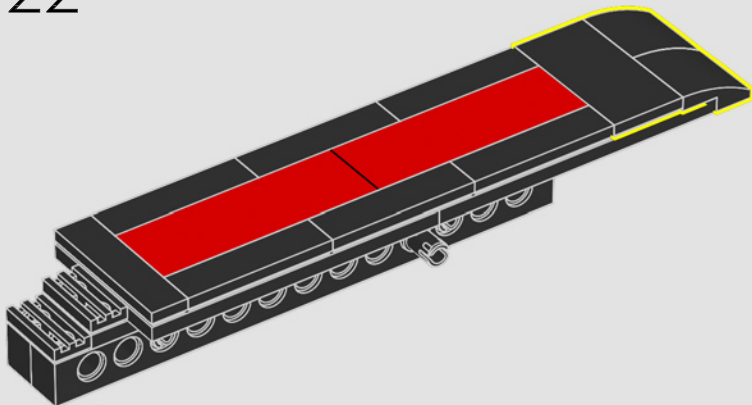

123

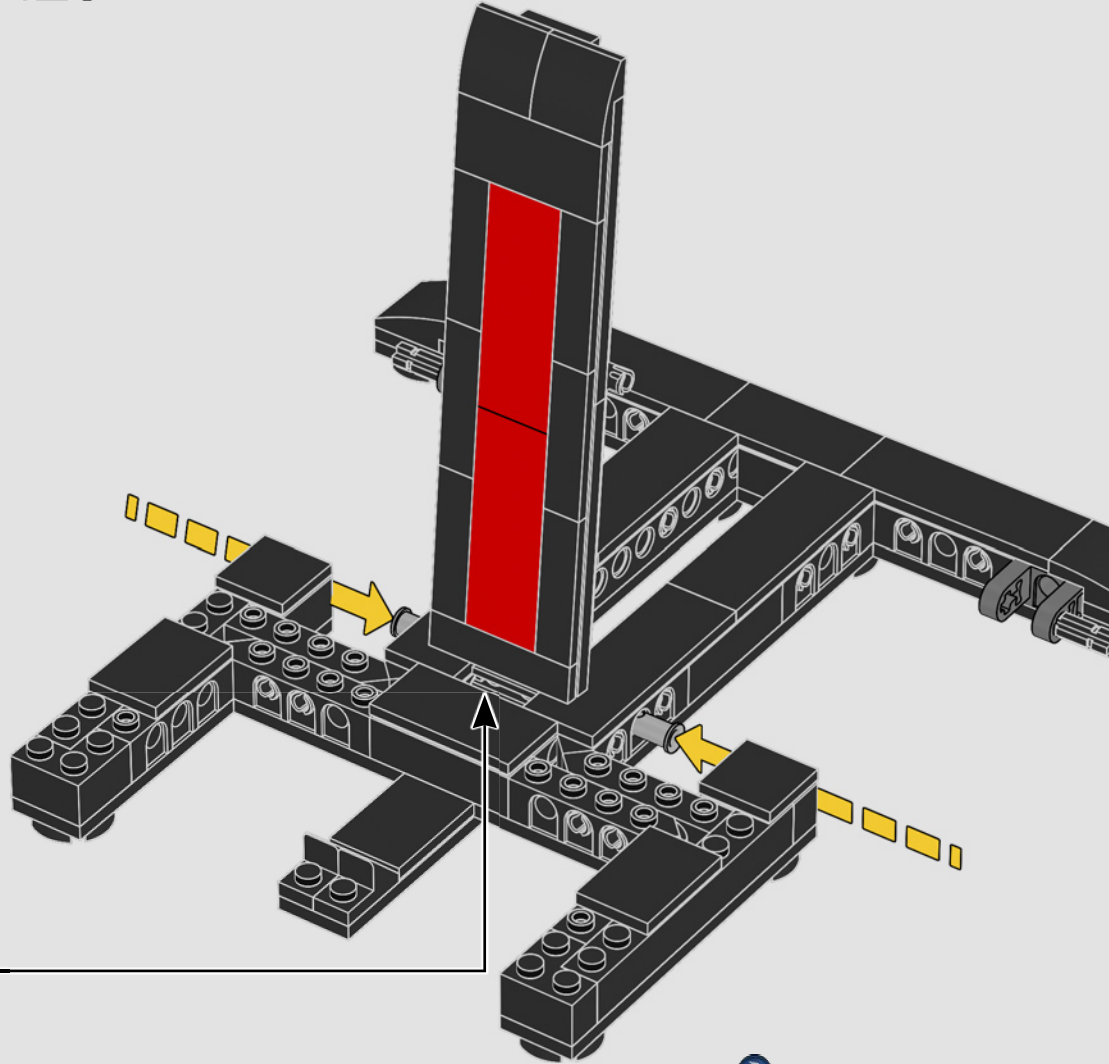

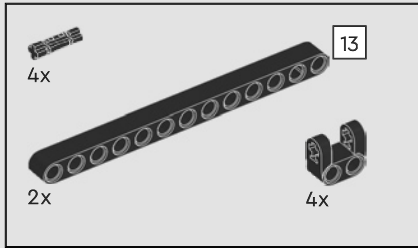
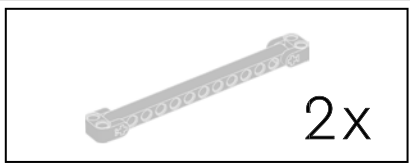

124

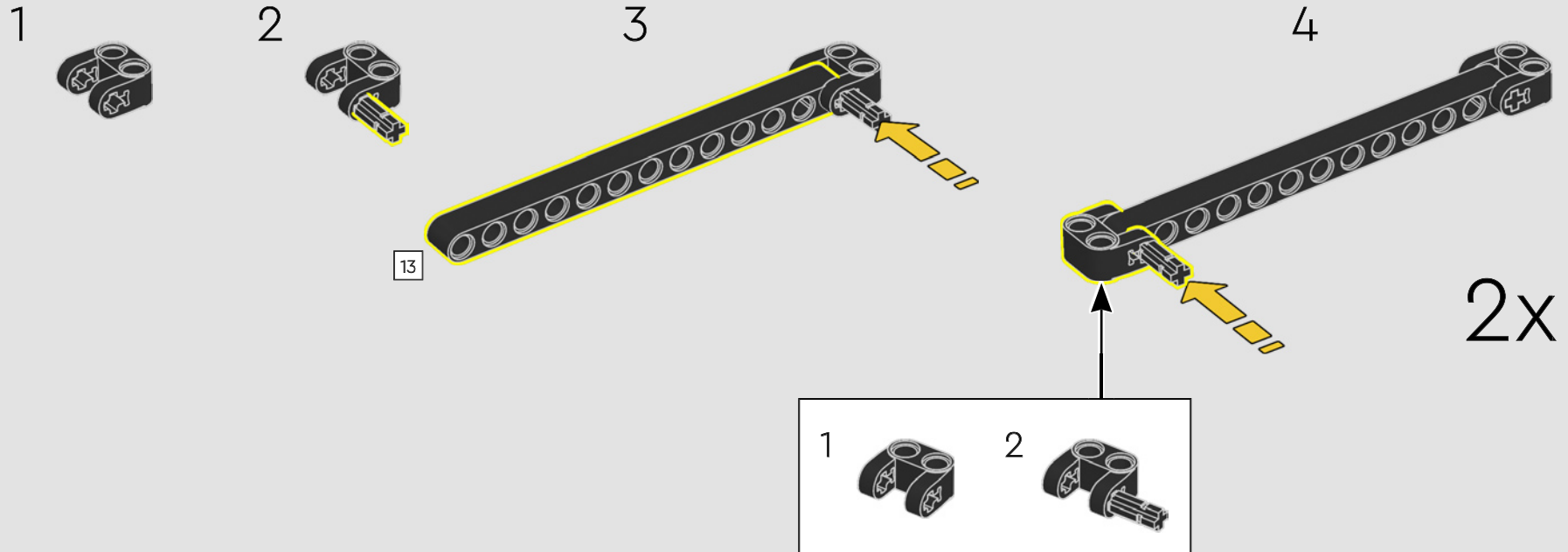

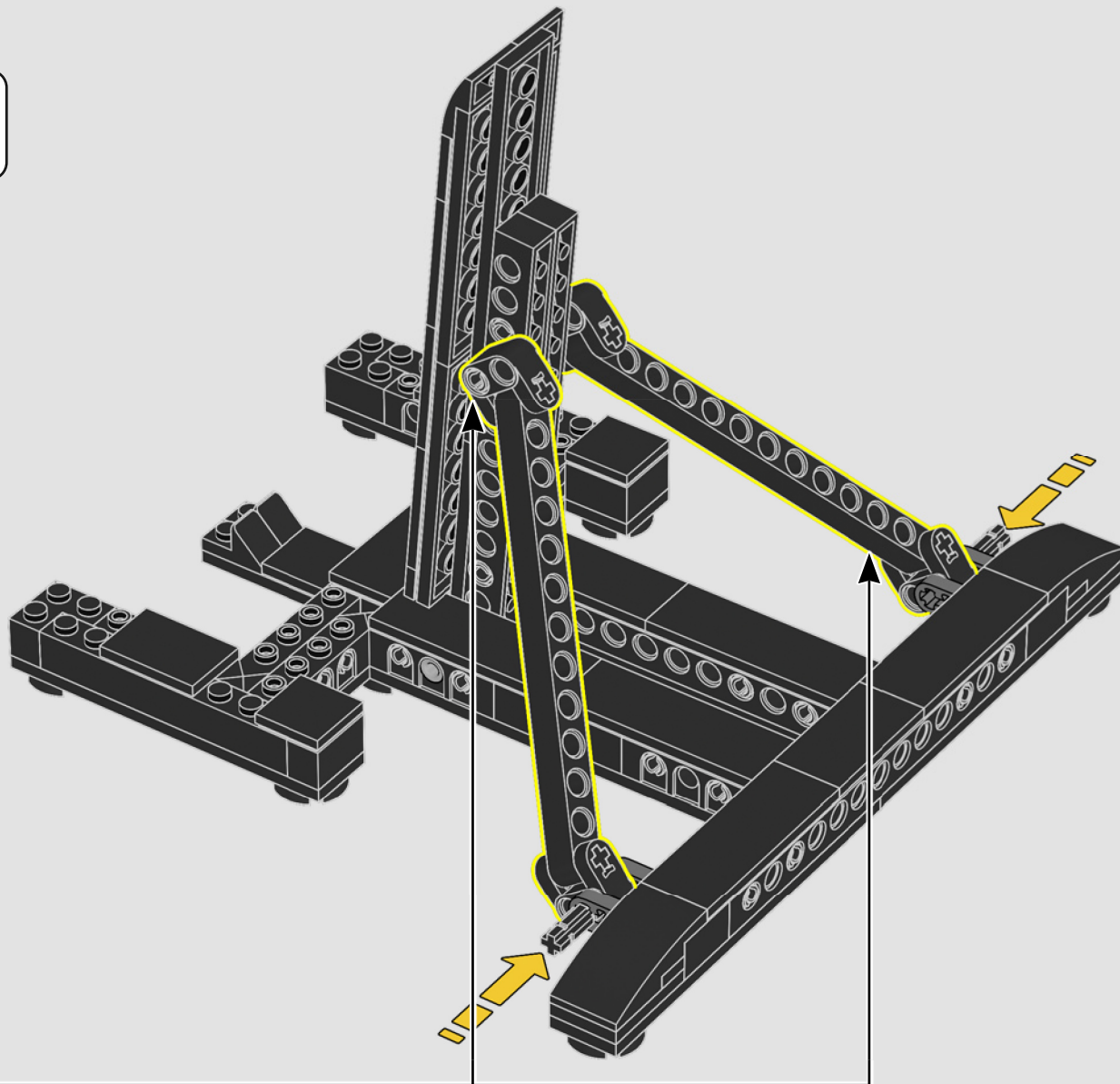

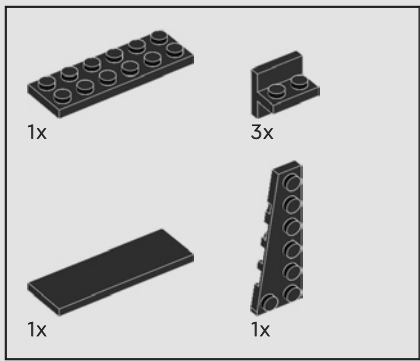

125

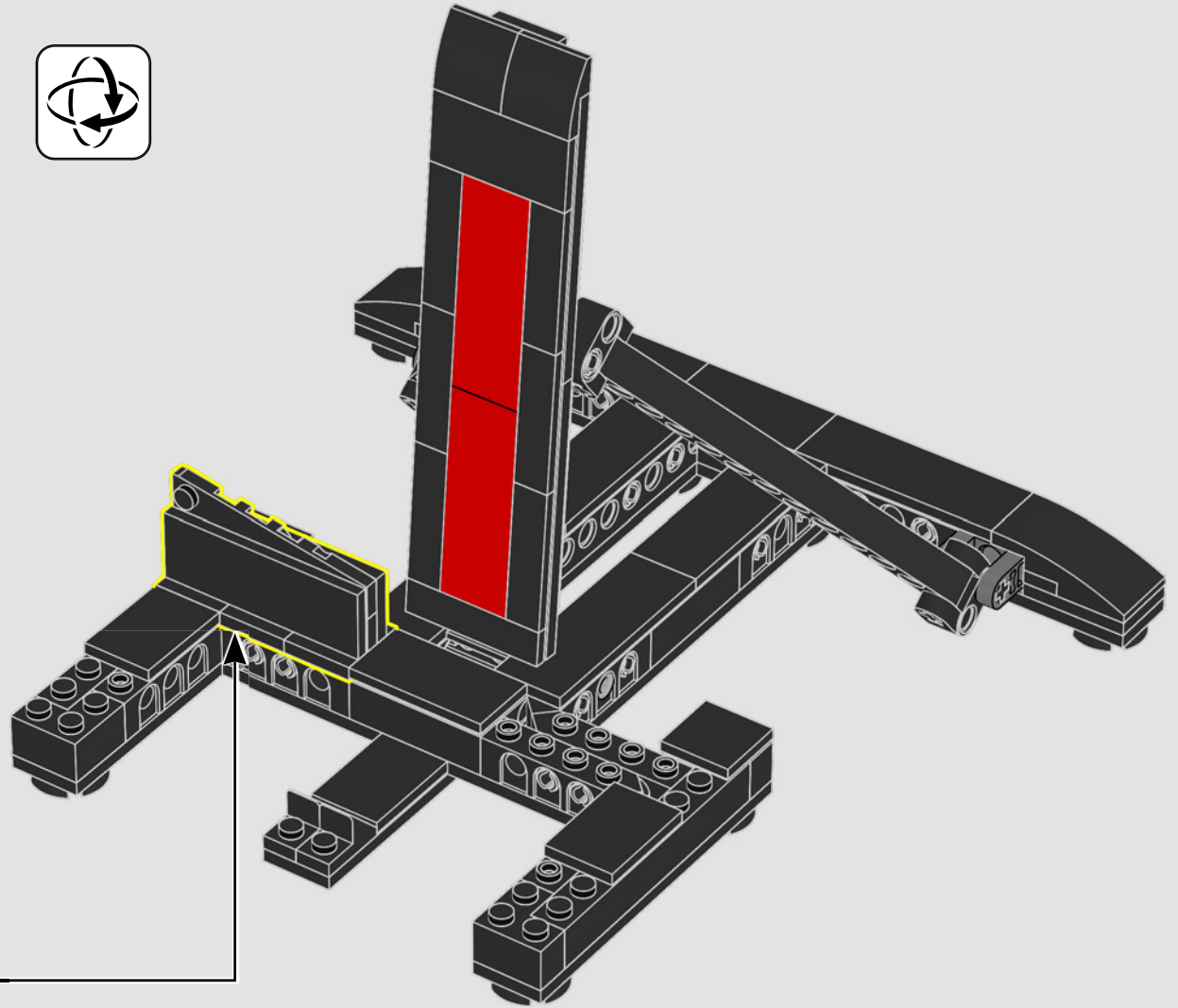
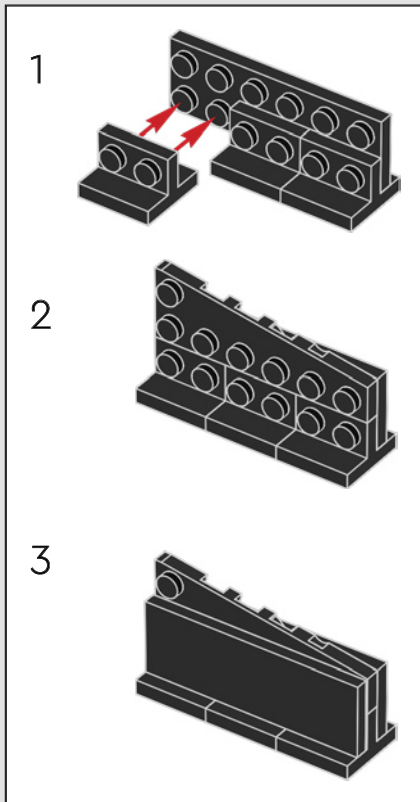

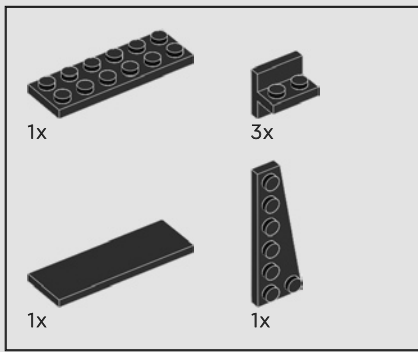

126

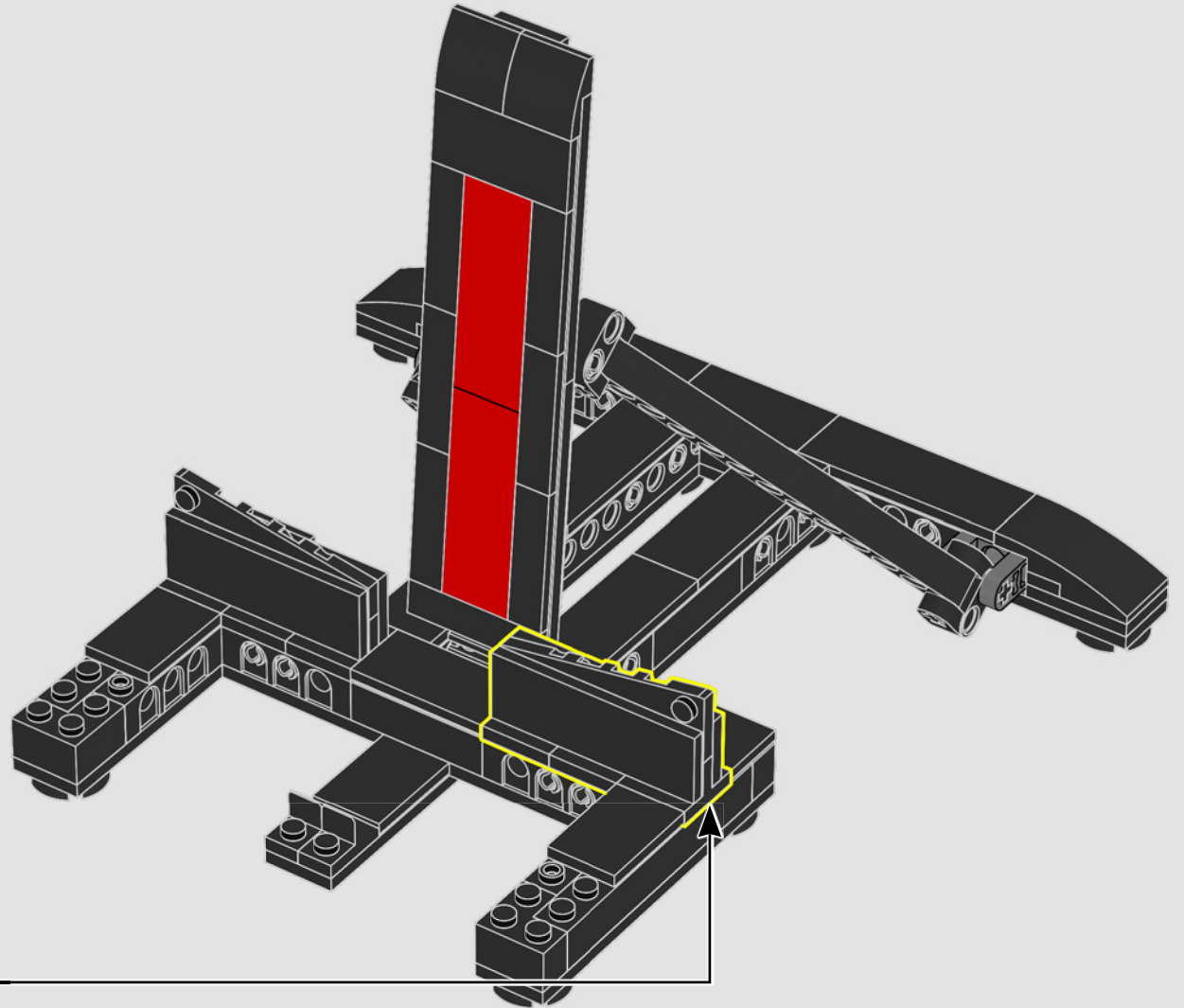
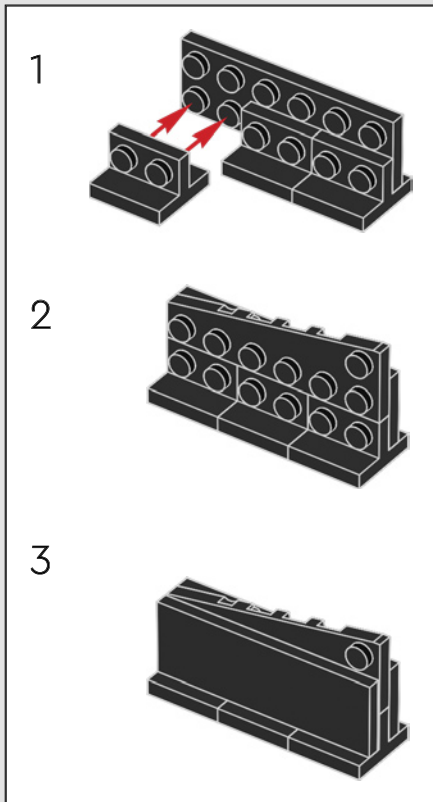

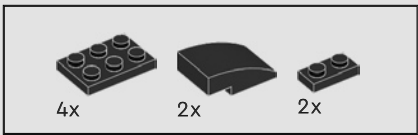

127

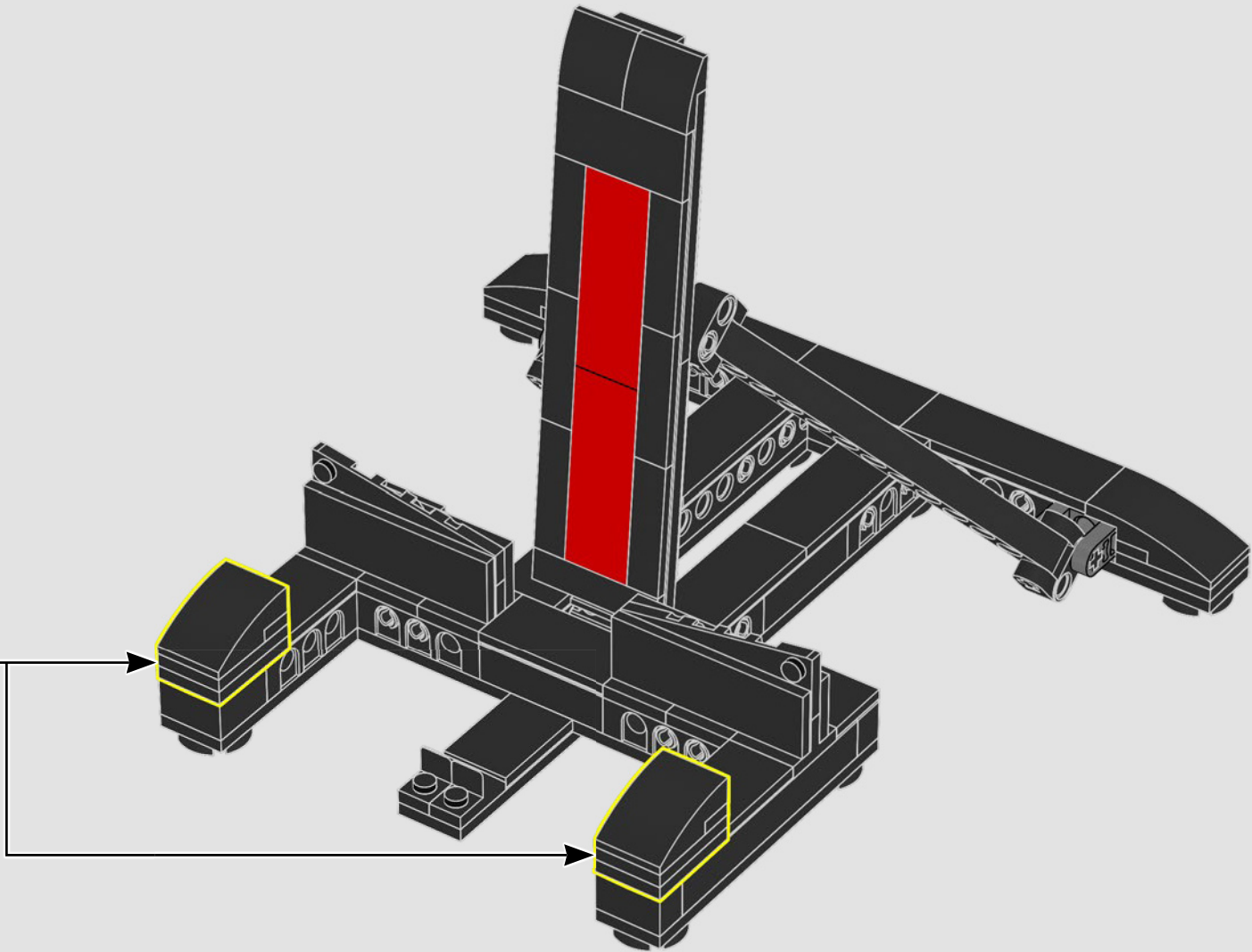
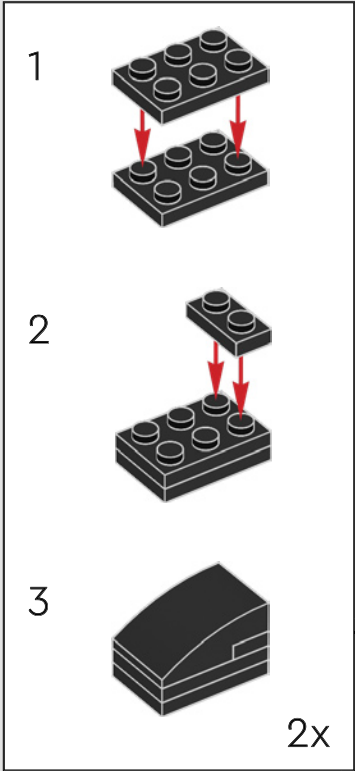

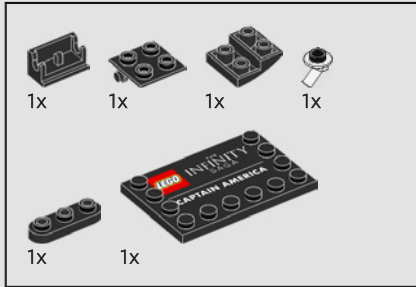

128

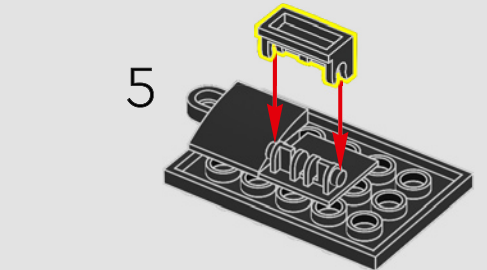
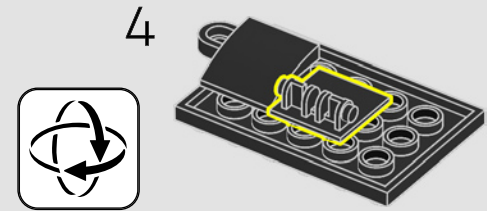
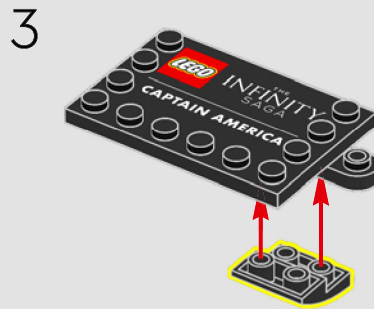
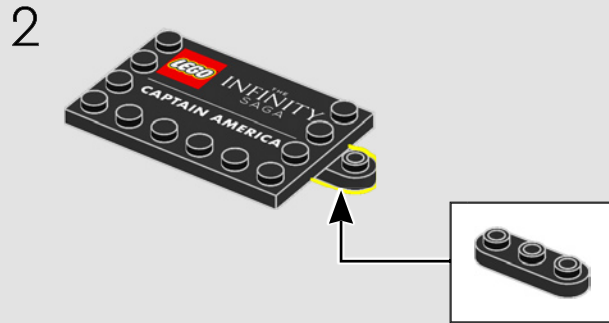

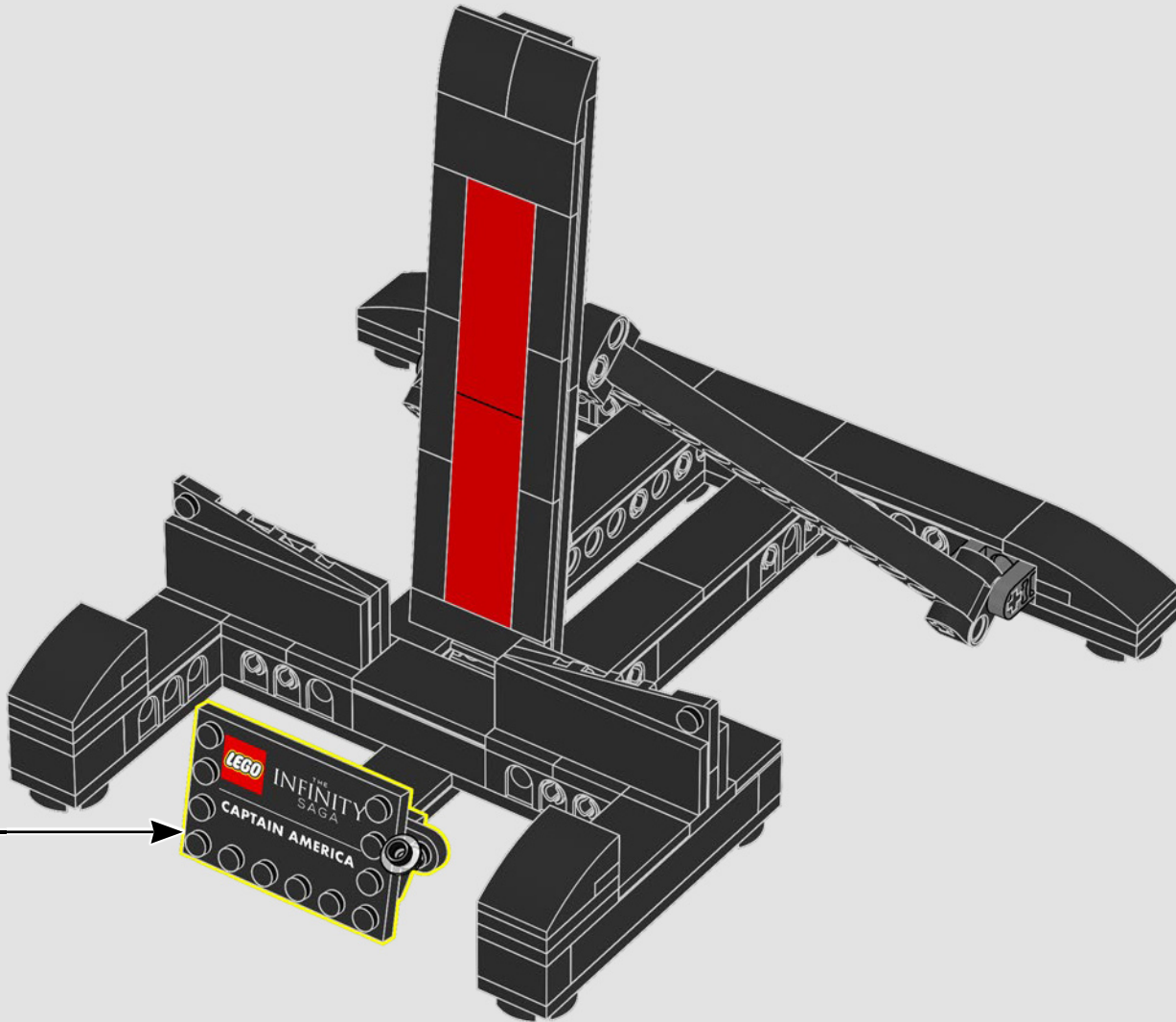

129

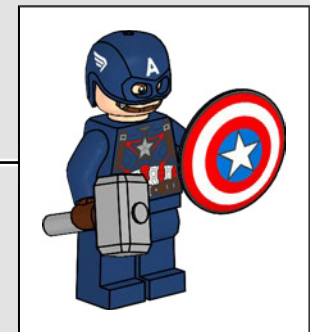
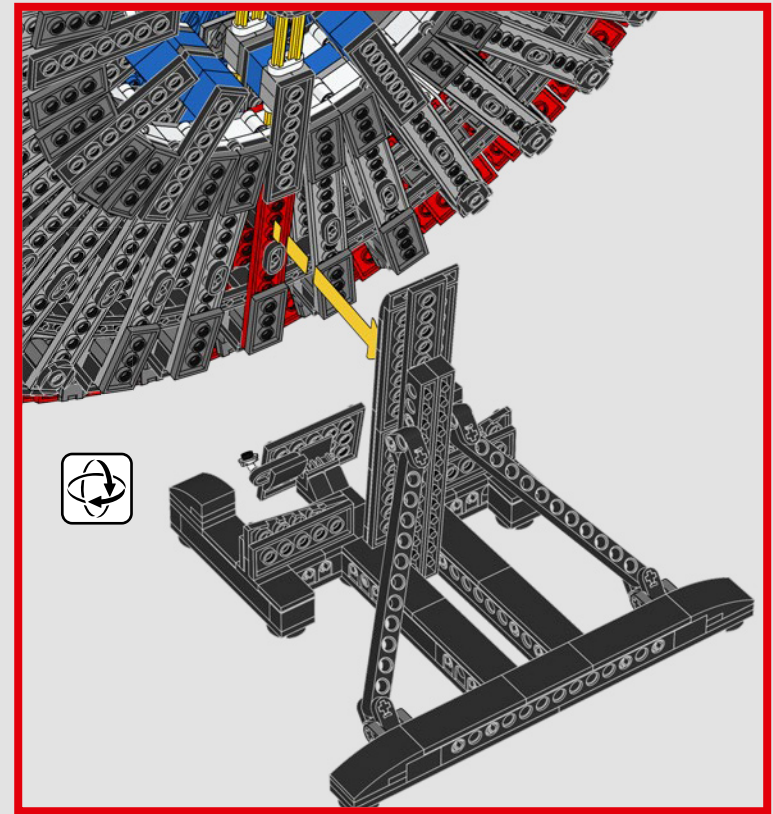
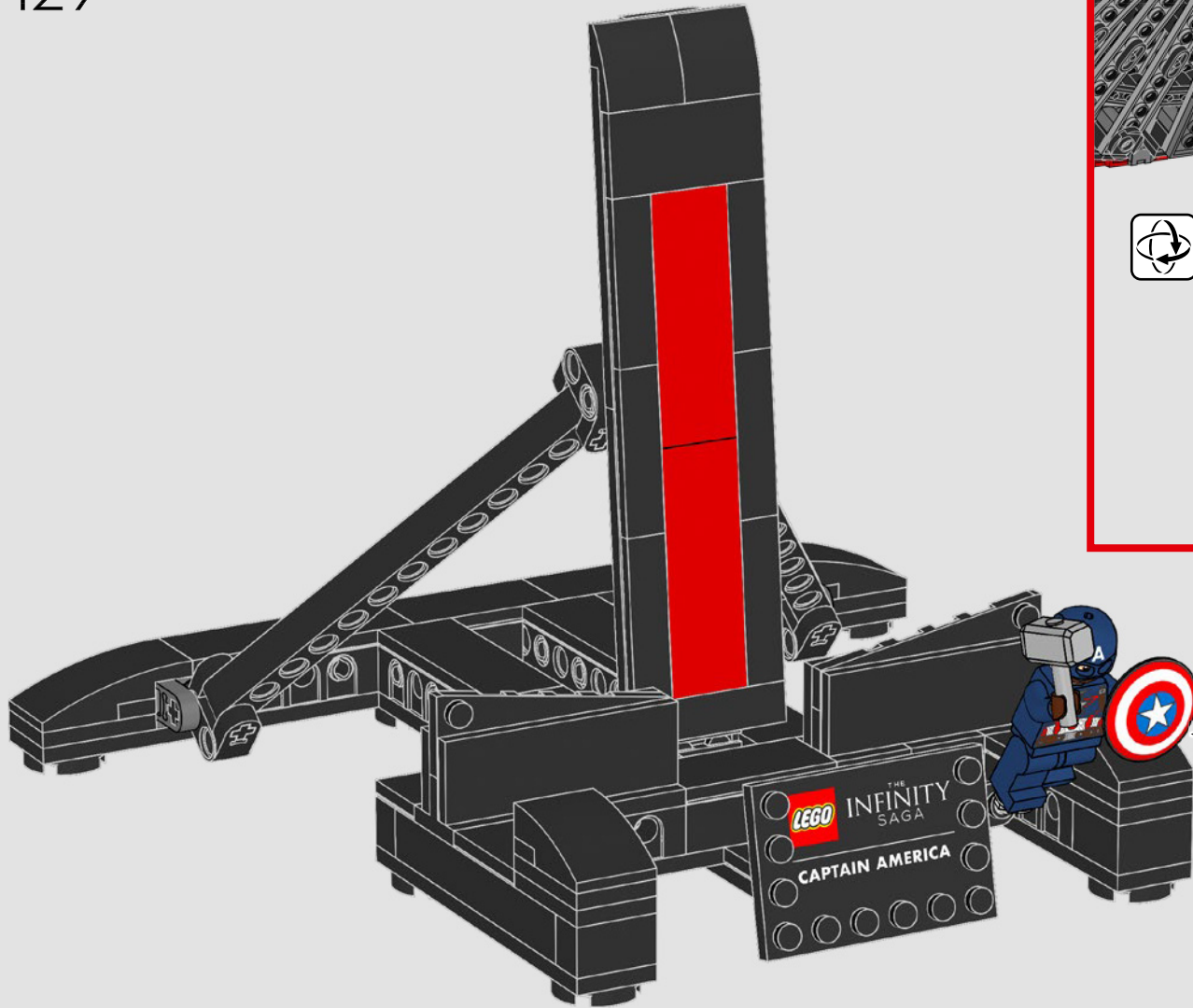

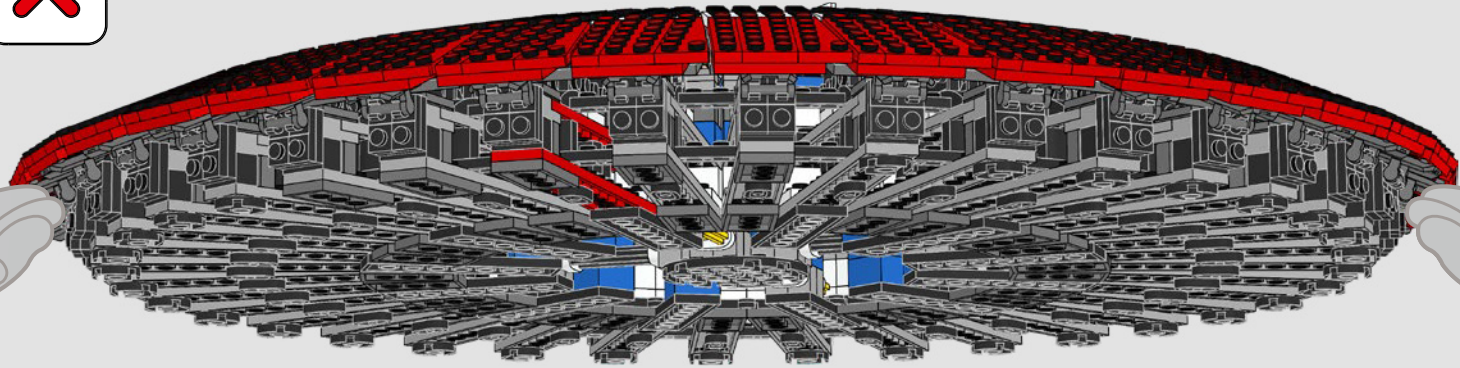
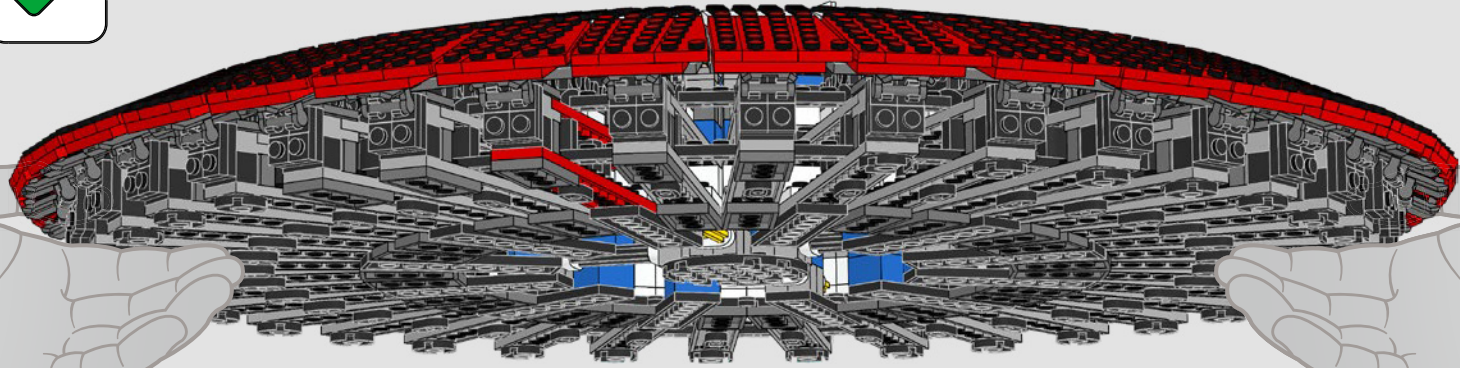

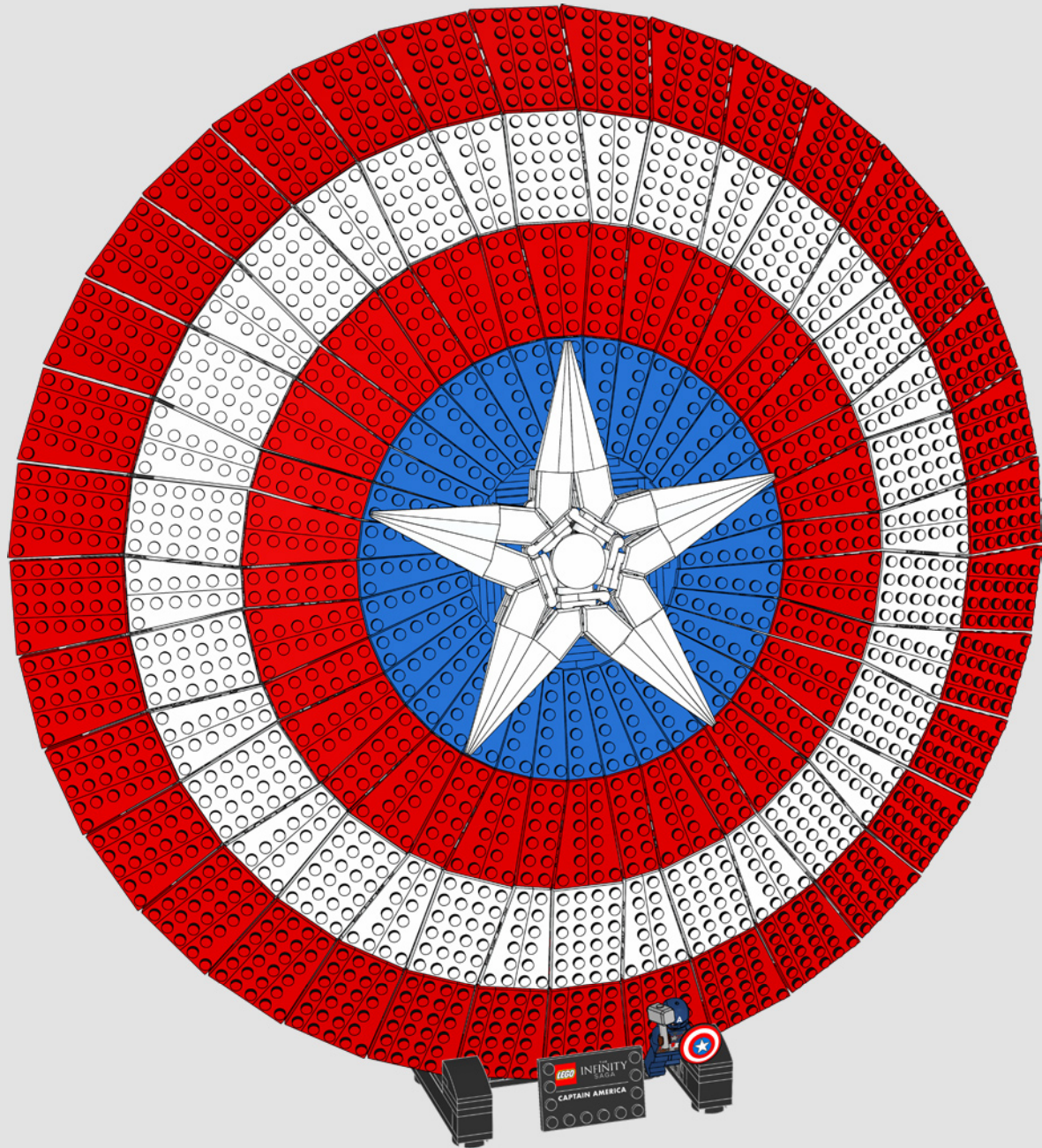



YOU COULD WIN



YOU COULD WIN

Your feedback will help shape the future development of this product series.

Visit:

DU KÖNNTEST GEWINNEN

Dein Feedback trägt zur Weiterentwicklung dieser Produktreihe bei.

Geh auf:

VOUS POURRIEZ GAGNER

Vos commentaires nous aideront à concevoir les futurs produits de cette gamme.

Visitez :

POTRESTI VINCERE TU

La tua opinione ci aiuterà a migliorare la creazione futura di questa linea di prodotti.

Visita:

PUEDES GANAR

Tu opinión contribuirá al futuro de esta serie de productos.

Visita:

轻松获奖

您的反馈将有助于我们在今后改进本产品系列。

请访问:

[LEGO.com/productfeedback](https://www.lego.com/productfeedback)

You also have the chance to win a LEGO® set.

Terms and conditions apply.*

Außerdem hast du die Chance, ein LEGO® Set zu gewinnen.

Es gelten die Teilnahmebedingungen.*

Vous pourriez également gagner un ensemble LEGO®.

Des conditions s'appliquent.*

Hai anche la possibilità di vincere un set LEGO®.

Termini e condizioni sono applicabili.*

También tienes la oportunidad de ganar un set LEGO®.

Aplican términos y condiciones.*

您还有机会赢取乐高®套装。

条款和条件适用。*

*[LEGO.com/productfeedback-terms](https://www.lego.com/productfeedback-terms)

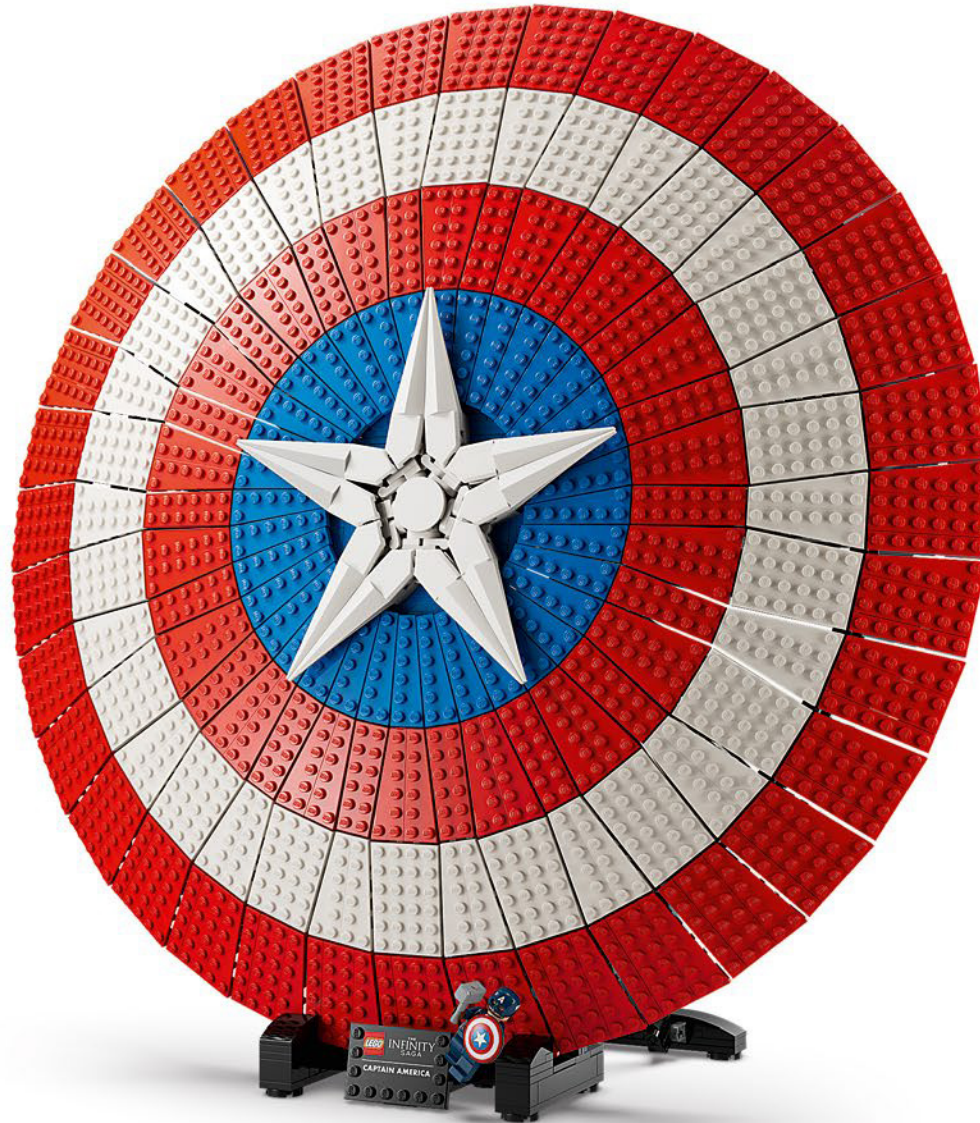

LEGO and the LEGO logo are trademarks of the/sont des marques de commerce du/son marcas registradas de LEGO Group. ©2023 The LEGO Group.
© 2023 MARVEL