



MARVEL

76279







LEGO® Builder



LEGO.com/sustainable-packaging



 ^{FR} **DONNEZ**
OU
RECYCLEZ

 OU  OU 

ASSOCIATION MAGASIN DÉCHÈTERIE

Adresses sur quefairedemesdechets.fr

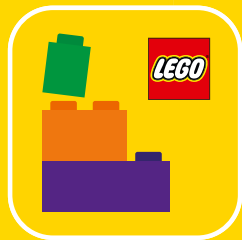

Q LEGO® Builder

BUILDER



Apple and the Apple logo are trademarks of Apple Inc., registered in the U.S. and other countries and regions. App Store is a service mark of Apple Inc. Google Play and the Google Play logo are trademarks of Google LLC. Tencent and the Tencent logo are trademarks of Tencent Inc.

Q [LEGO.com/devicecheck](https://lego.com/devicecheck)

EN Ask parents' permission before going online | **DE** Eltern um Erlaubnis bitten, bevor du online gehst | **FR** Demande l'autorisation d'un parent avant d'aller en ligne | **IT** Chiedi il permesso ai tuoi genitori prima di andare online | **ES** Pídeles permiso a tus papás antes de conectarte a Internet | **PT** Pede autorização aos pais antes de acederes online | **ZH** 上网前应先征得父母的同意 | **PL** Poproś rodziców o zgodę, zanim wejdziesz do Internetu | **CS** Než půjdeš na internet, požádej rodiče o svolení | **SK** Skôr než pôjdeš na internet, vypýtaj si povolenie od rodičov | **HU** Kérj szülői engedélyt, mielőtt online csatlakoznál! | **RO** Cere permisiunea părinților înainte de a te conecta online | **BG** Поискайте разрешение от родител, преди да влезете онлайн | **LV** Pirms došanās tiešsaistē palūdz atļauju vecākiem | **ET** Enne Interneti kasutamist küsi vanematelt luba | **LT** Prieš prisijungdami prie interneto, atsiklauskite tėvų

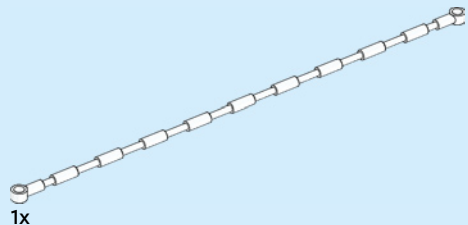
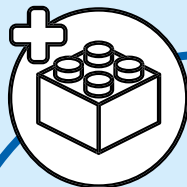

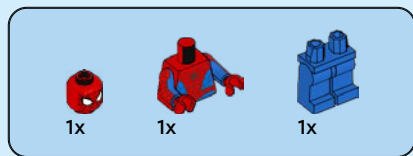

1

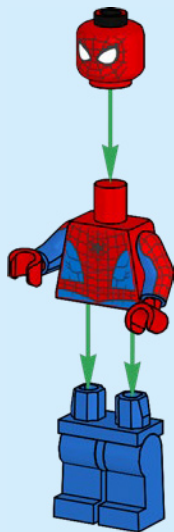

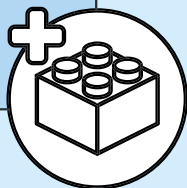
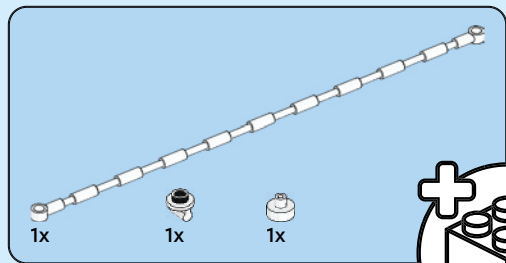

2

1



2

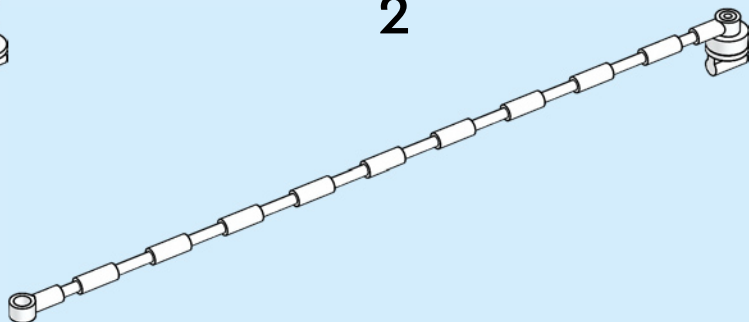

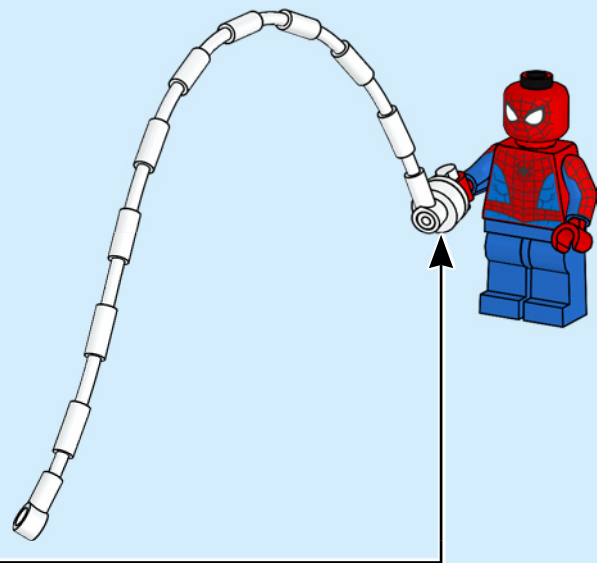

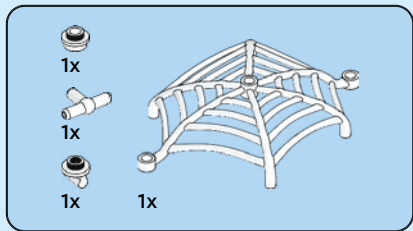

3

1

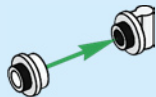

2

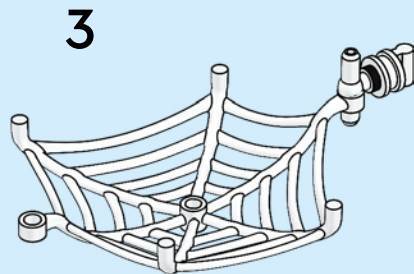
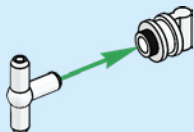

4

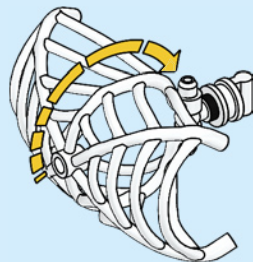

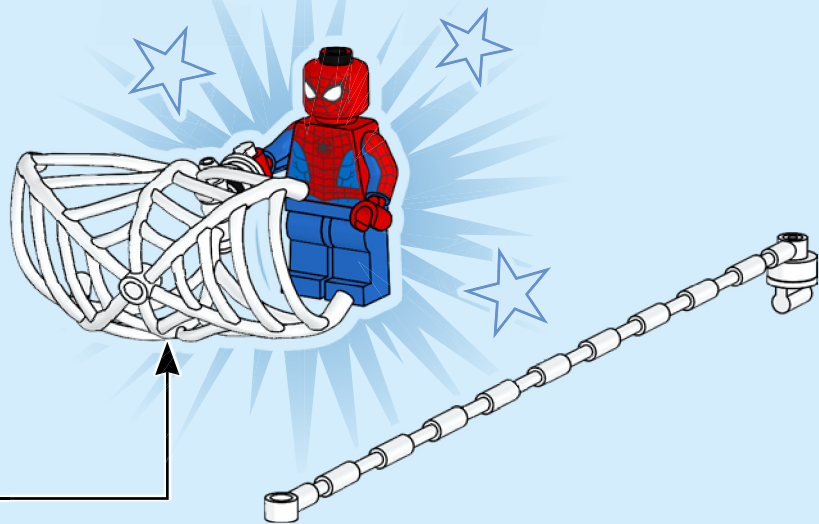

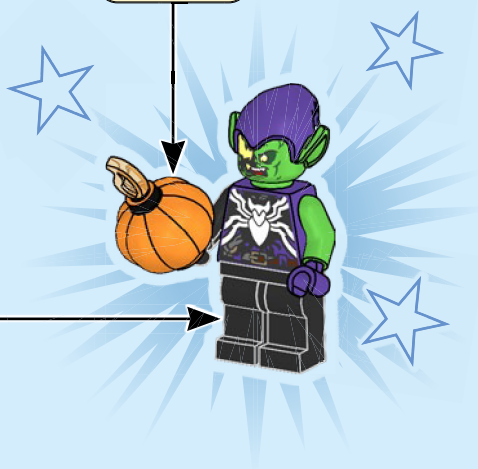
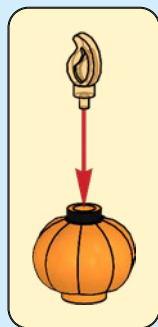
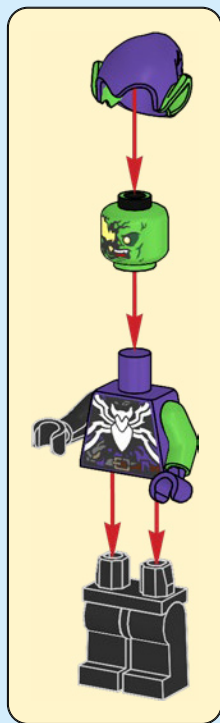

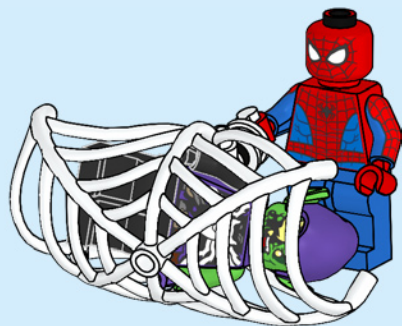

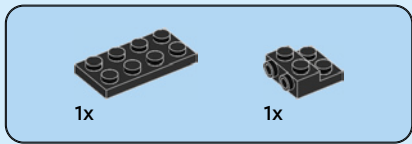
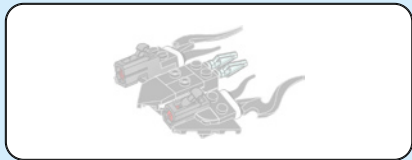

1

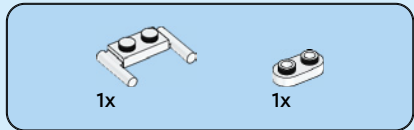
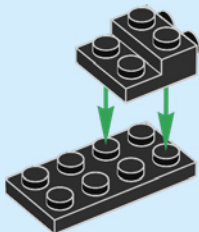

2

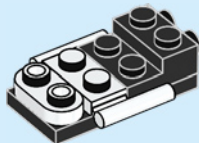



2x



1x

3

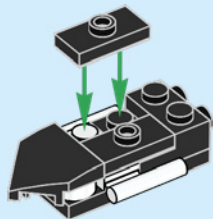

2x

4

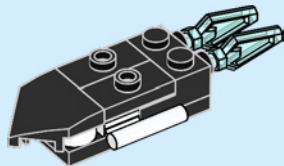



5

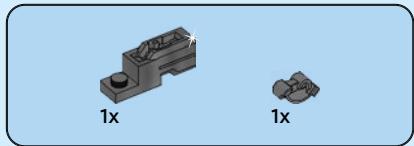
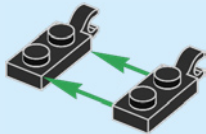

6

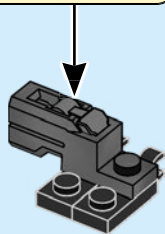
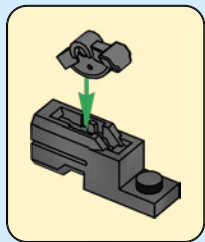

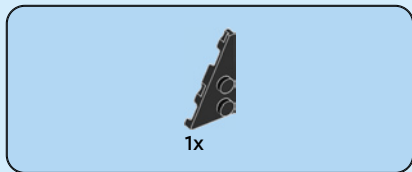

7

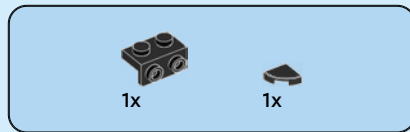
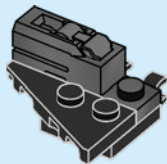

8

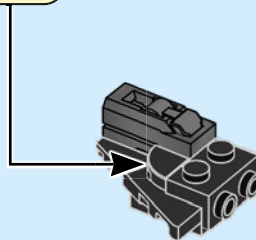



1x

9

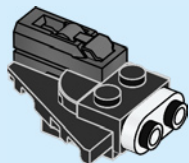

1x



1x

10

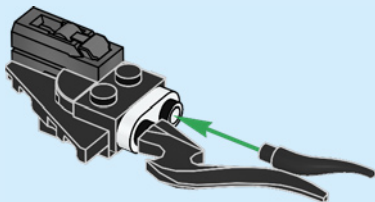

11

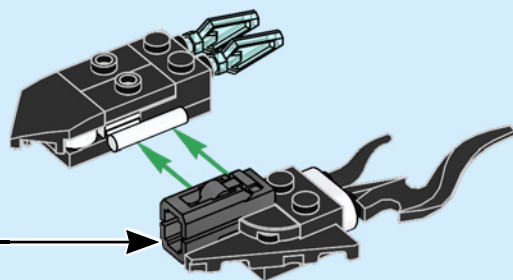



12

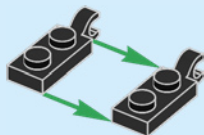

13

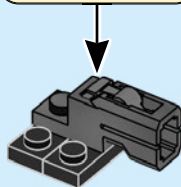
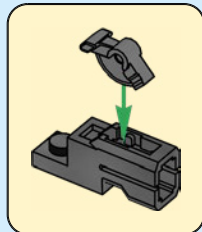

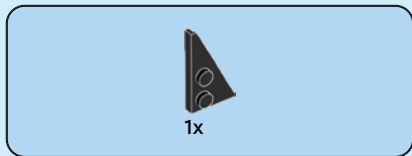

14

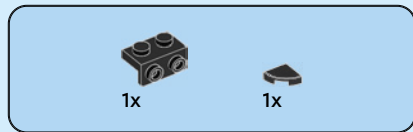
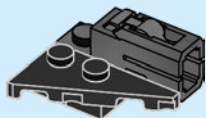

15

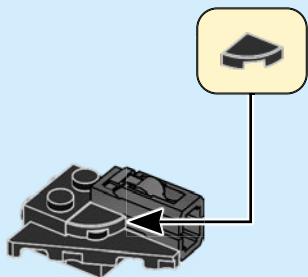



1x

16

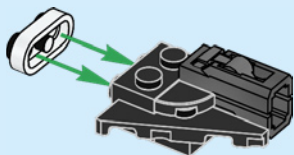

1x



1x

17

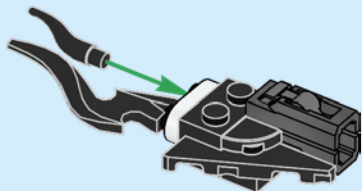

18

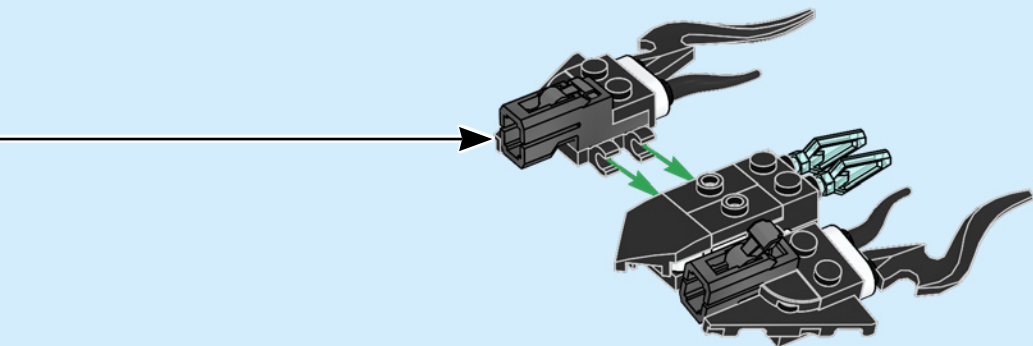



4x

19

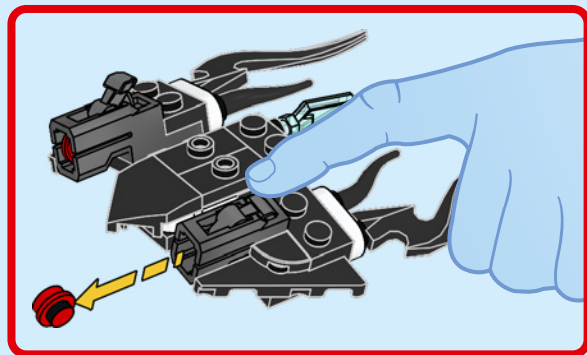
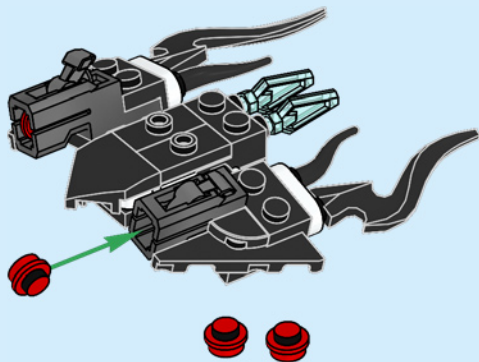



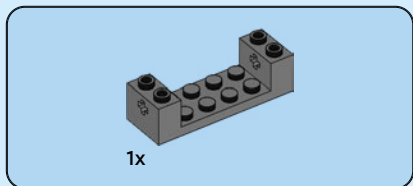
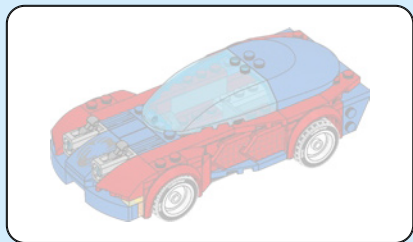

1

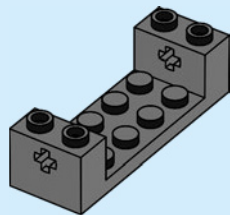

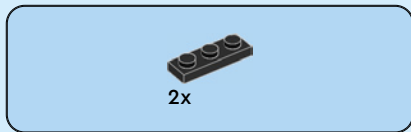

2

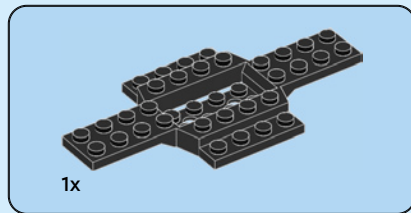
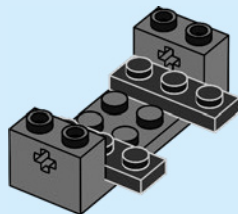

3

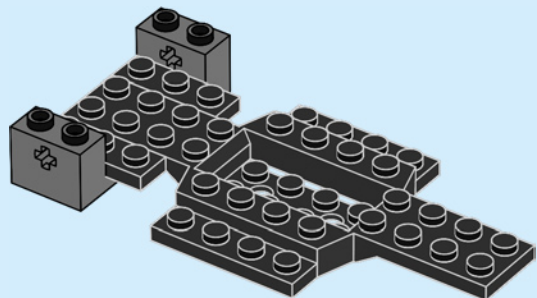

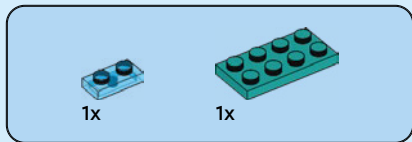

4

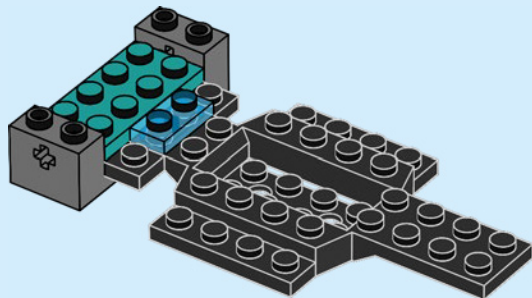

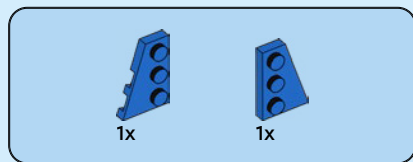

5

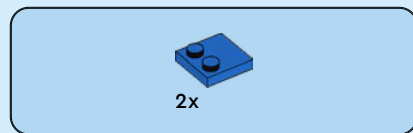
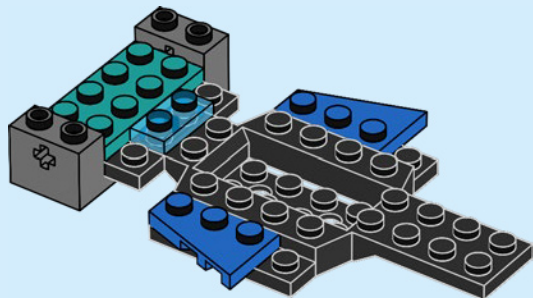

6

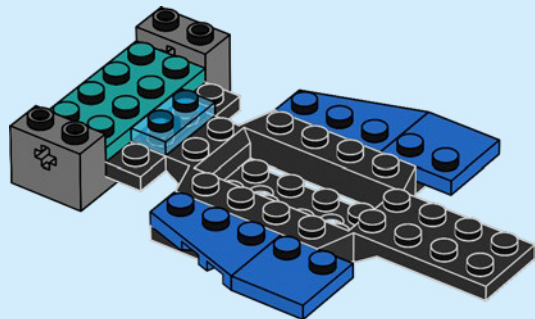

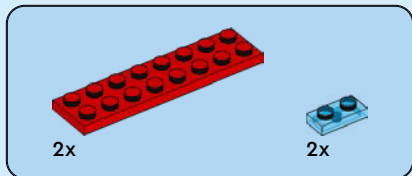

7

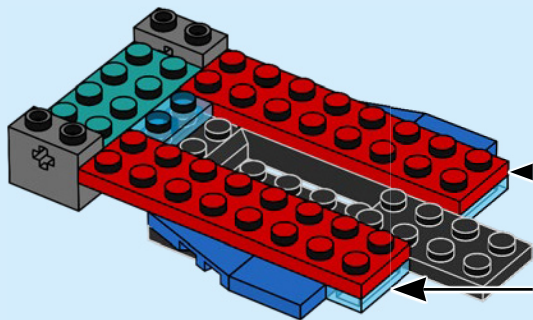
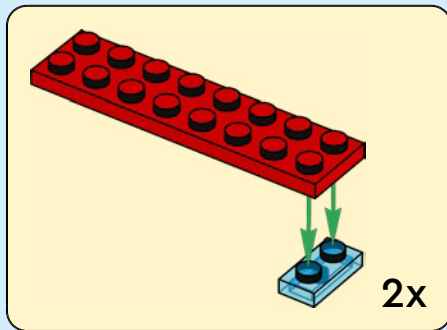



2x



1x

8

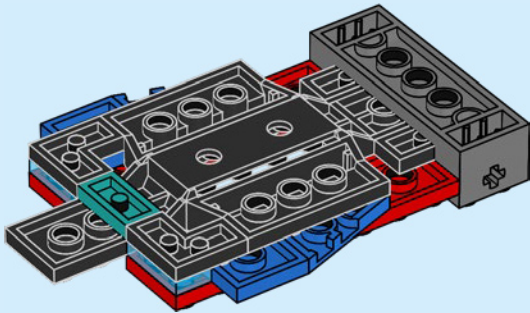

9

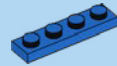

1x

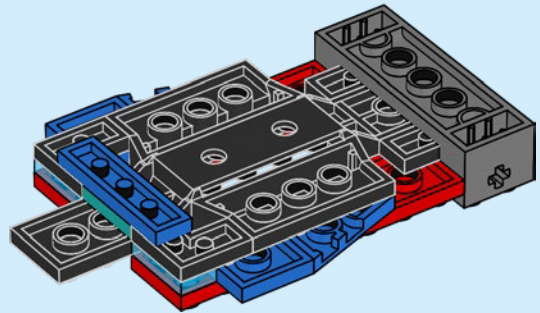

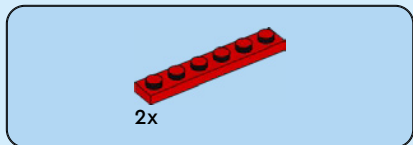

10

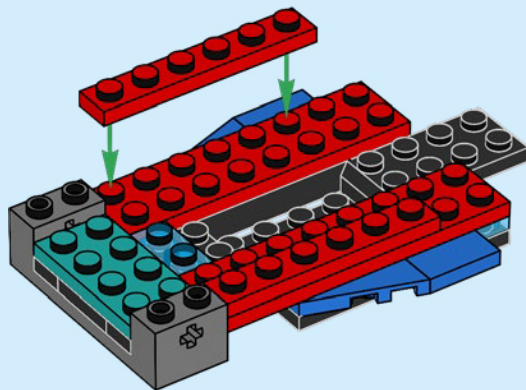

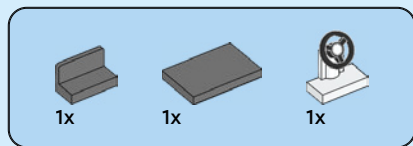

11

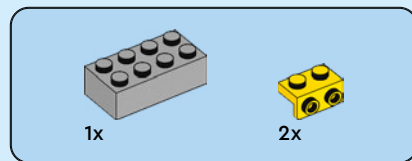
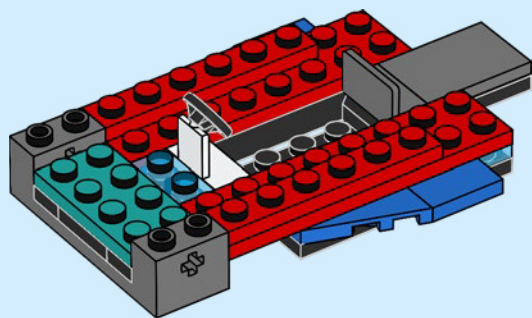

12

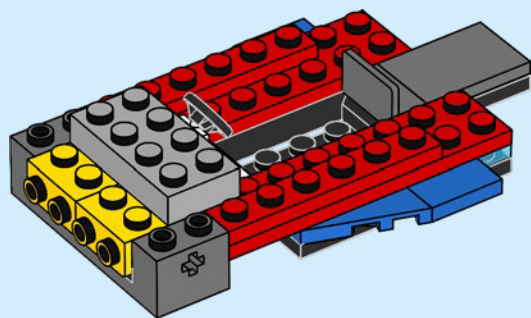

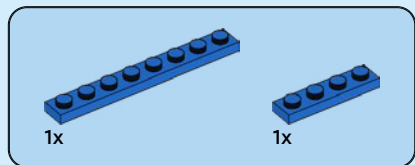
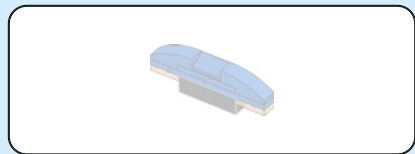

13

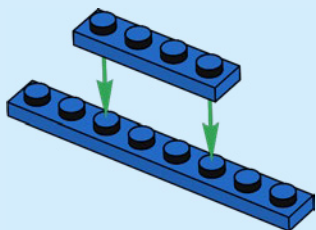

14

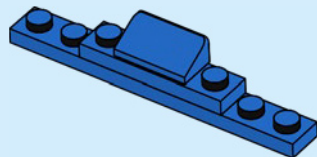



2x

15

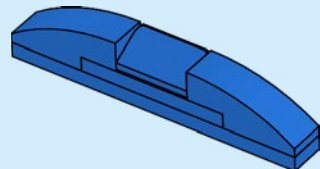

1x

16

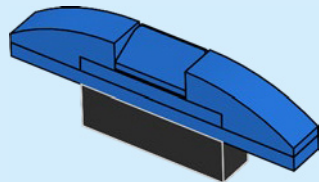



2x

17

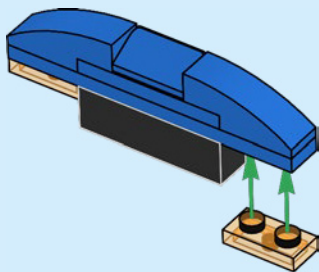

18

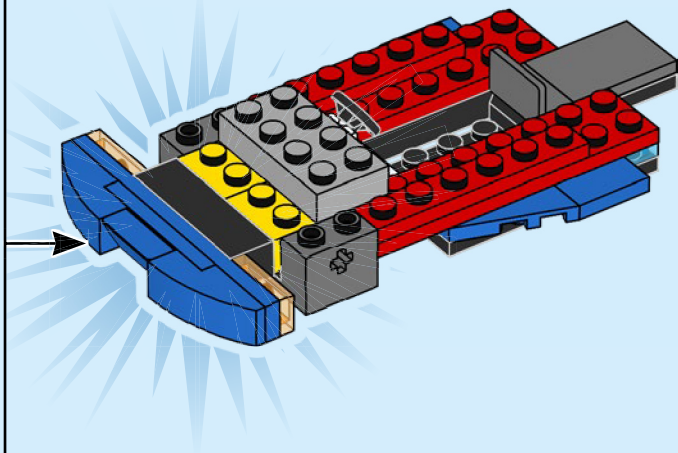

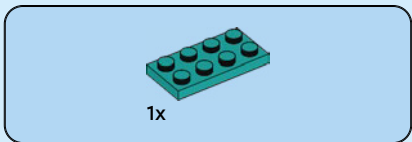

19

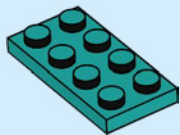

20

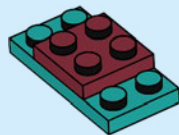

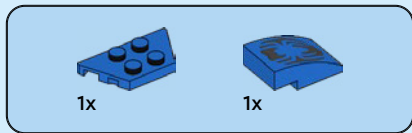

21

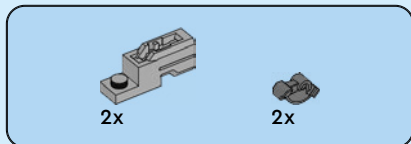
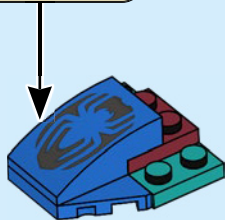
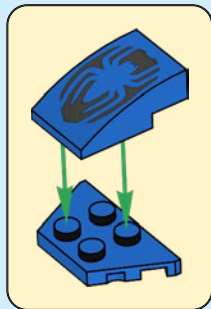

22

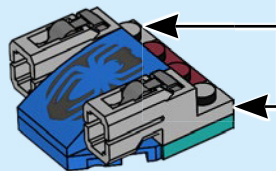
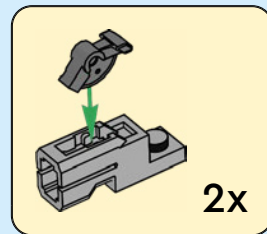

23

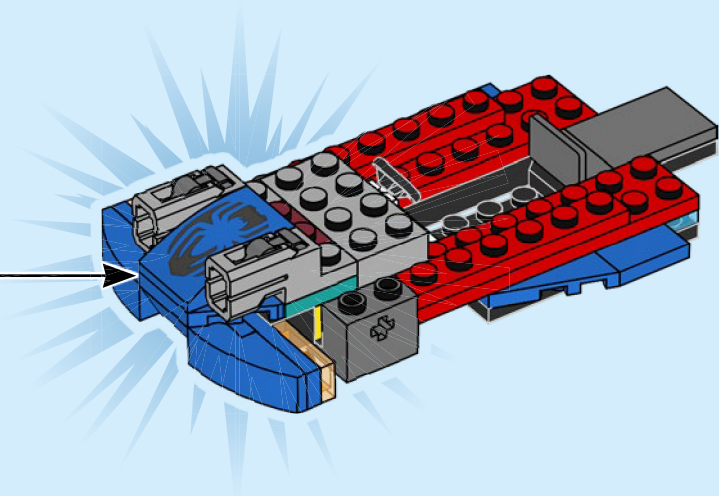

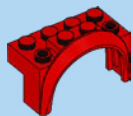

2x

24

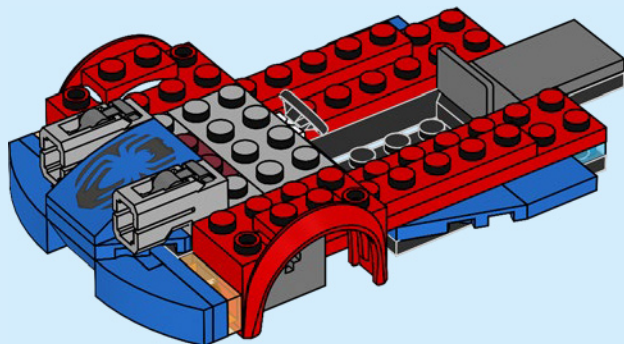

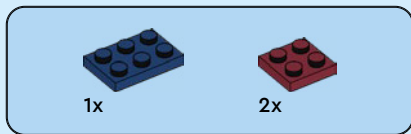

25

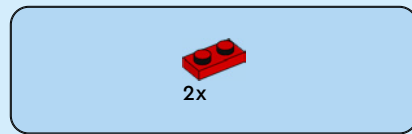
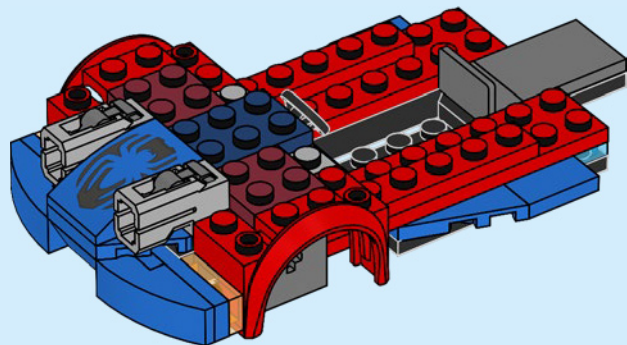

26

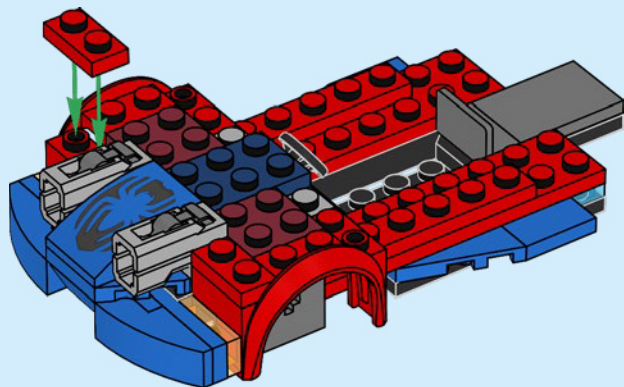

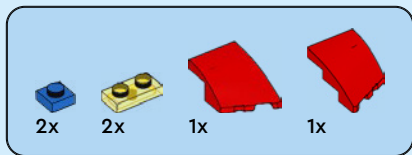

27

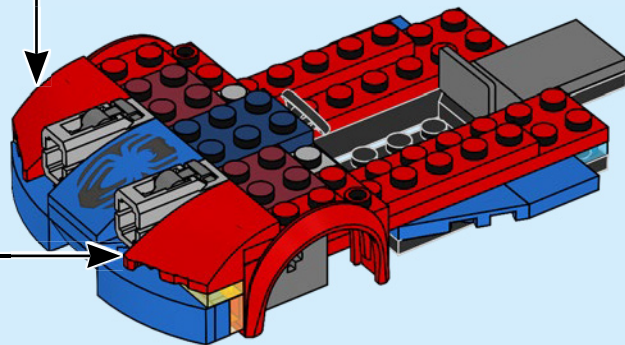
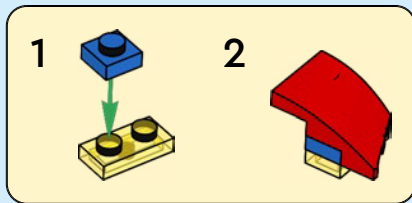
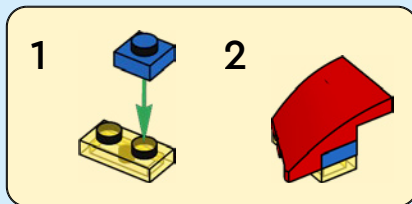



2x



2x

28

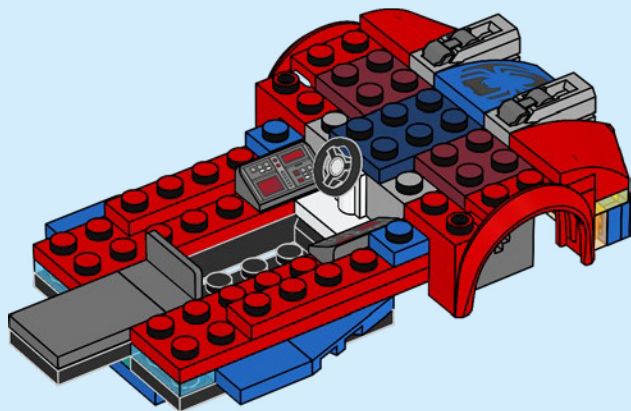



2x

29

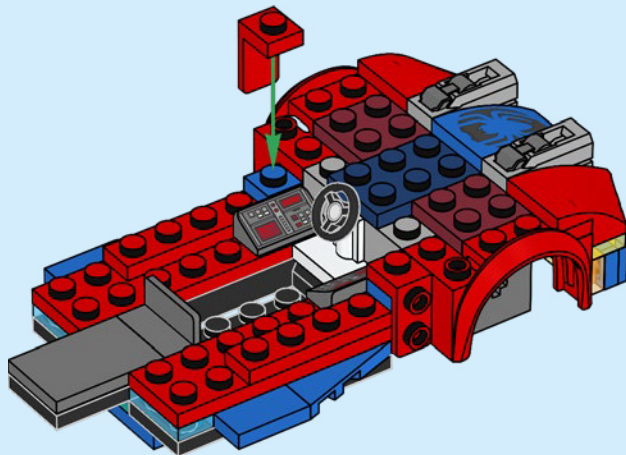



2x



2x

30

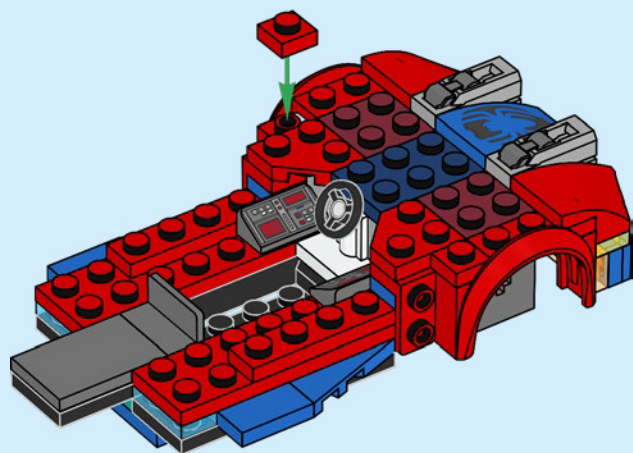

2x

31

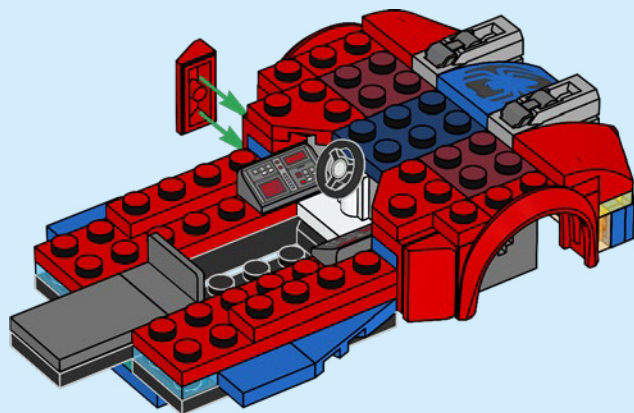



2x



2x



2x

32

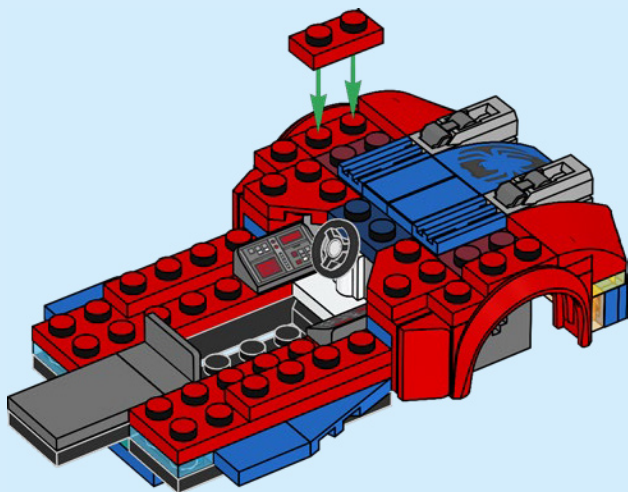



1x



1x



1x

33

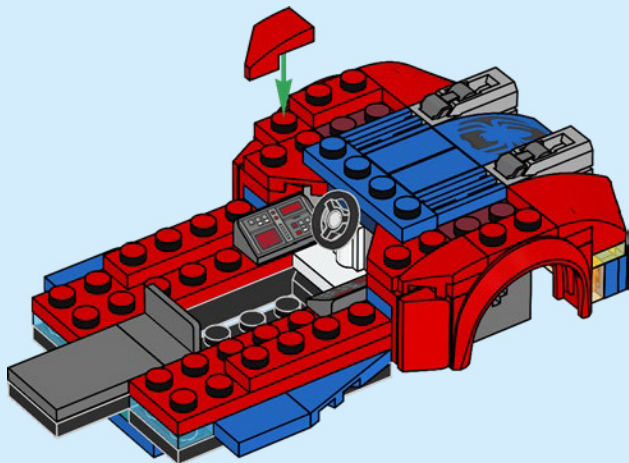

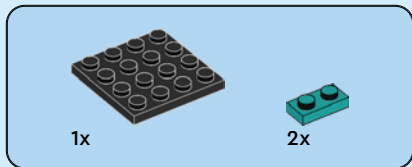

34

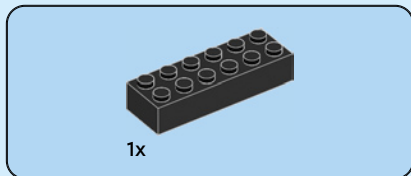
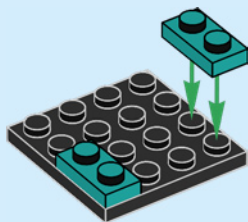

35

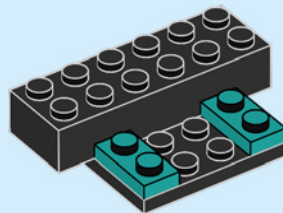

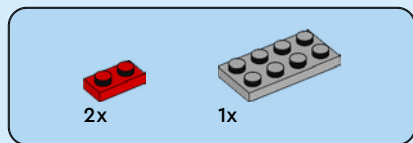

36

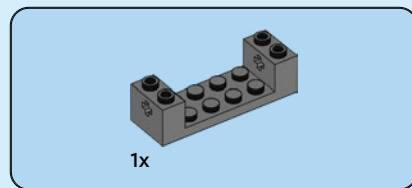
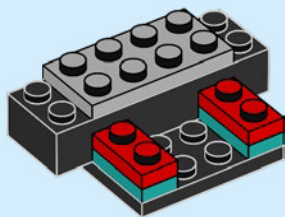

37

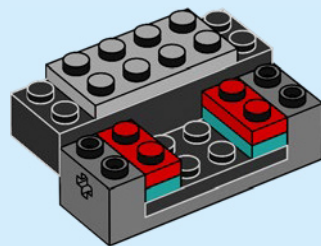

38

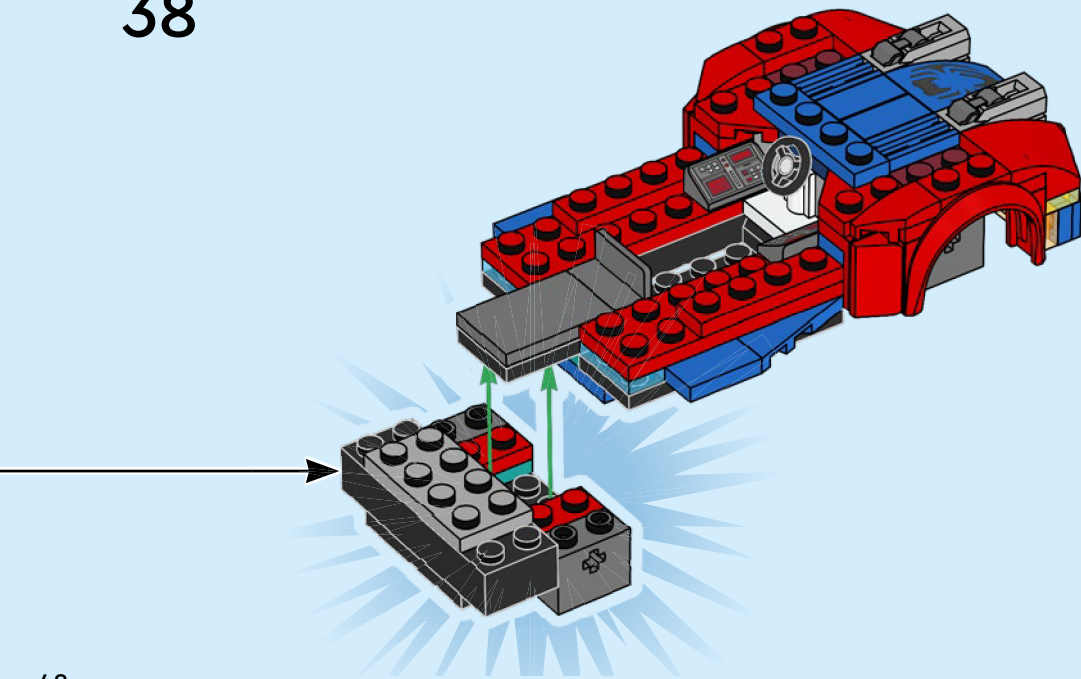



2x

39

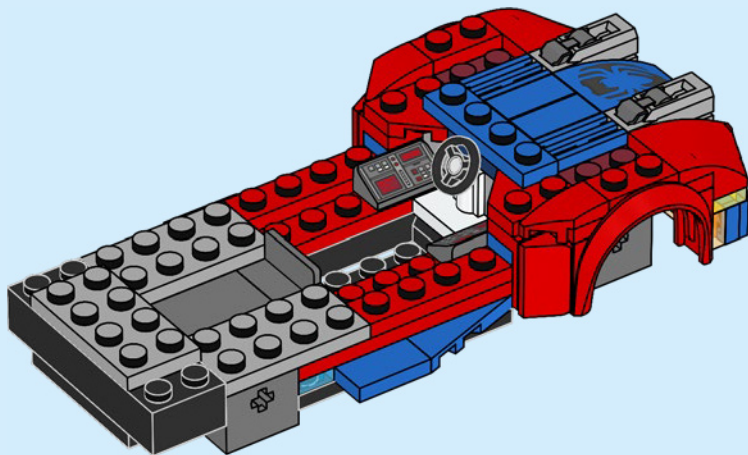



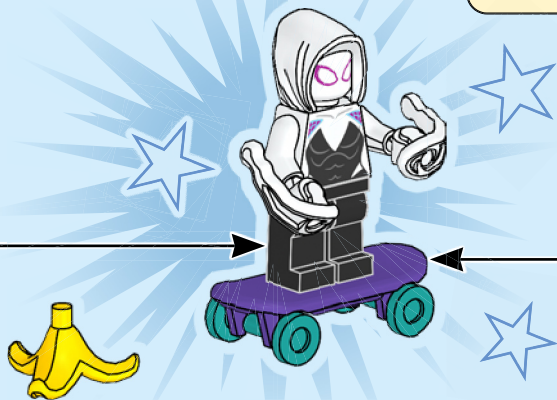
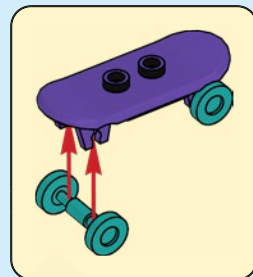
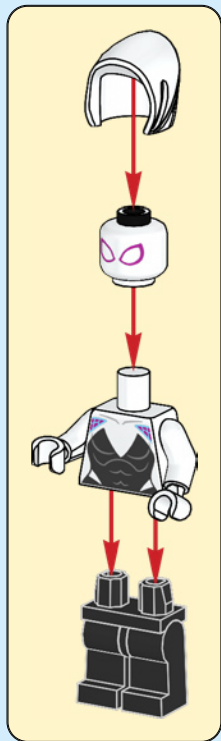

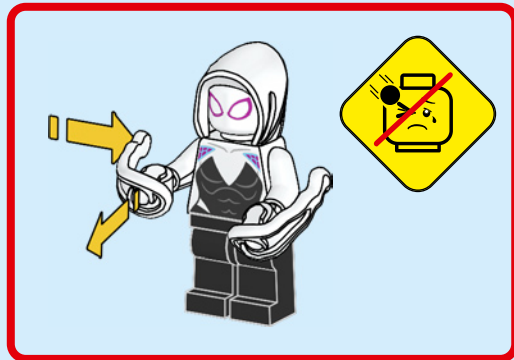

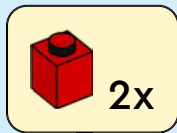
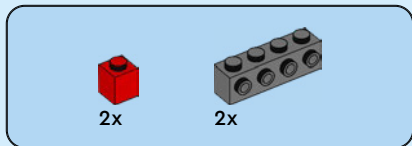

40

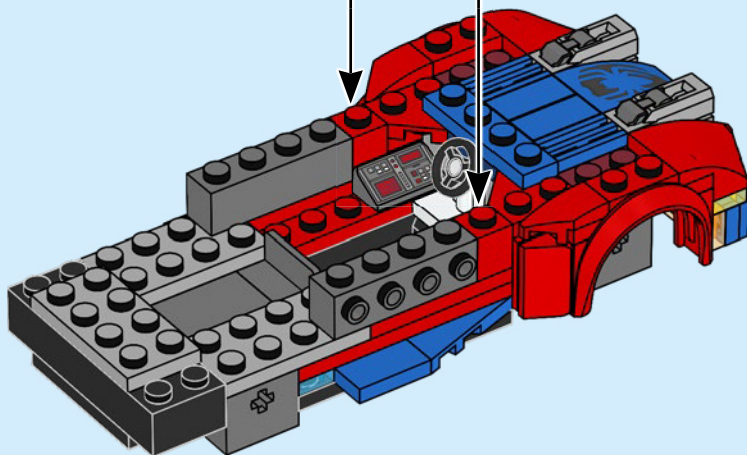



2x

41

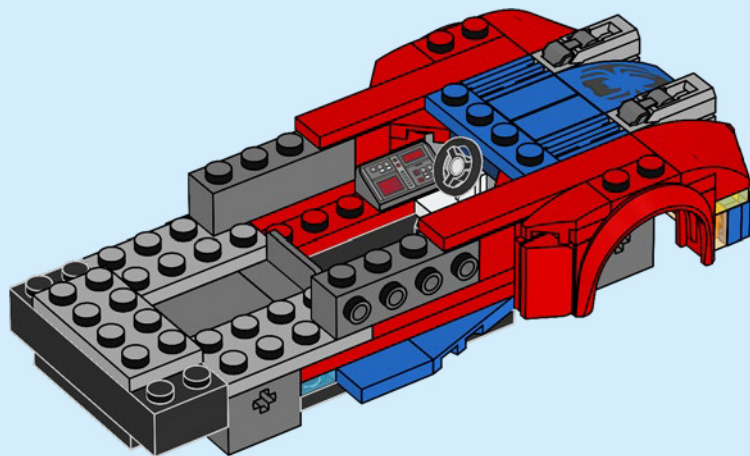



2x



2x



42

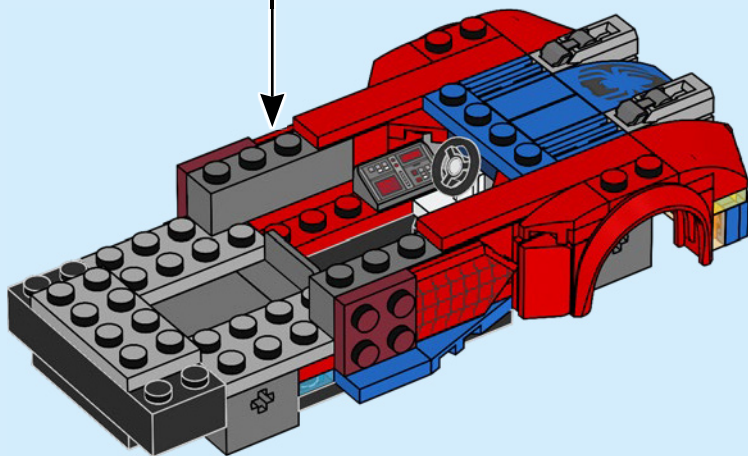



2x

43

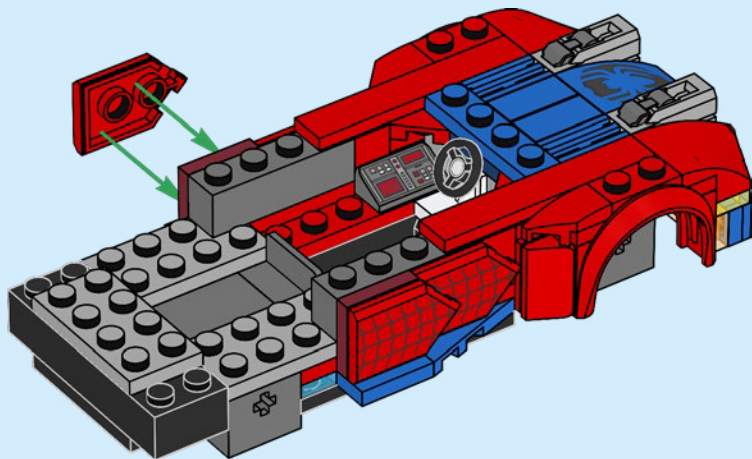



1x



1x

44

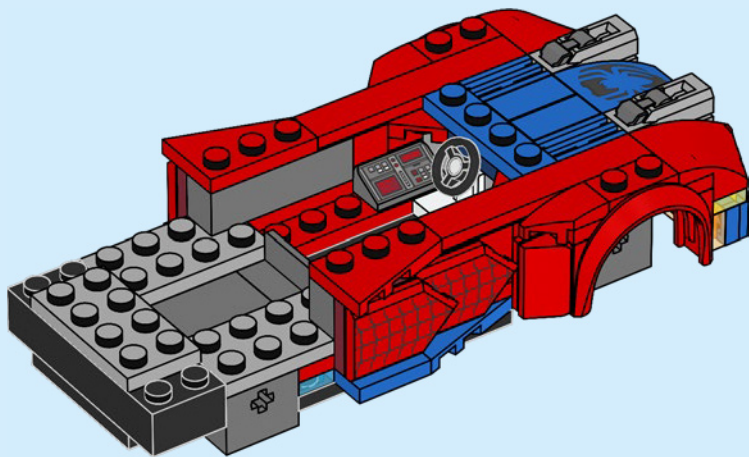

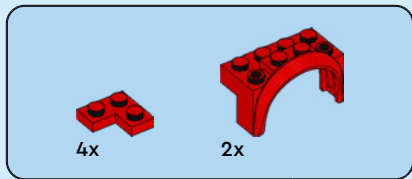

45

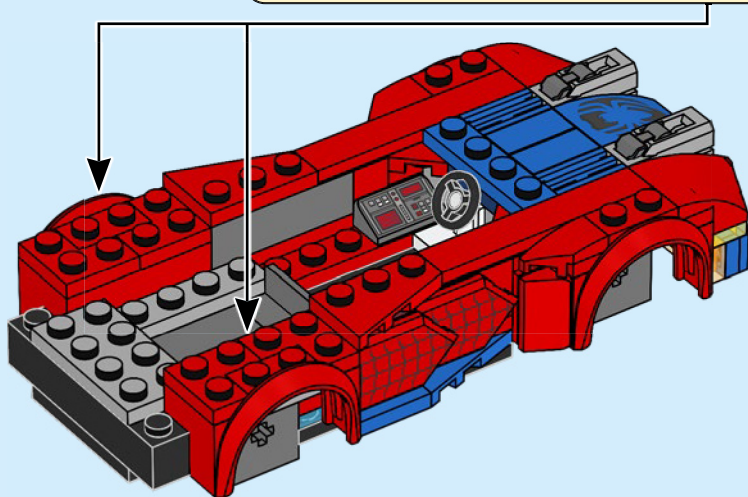
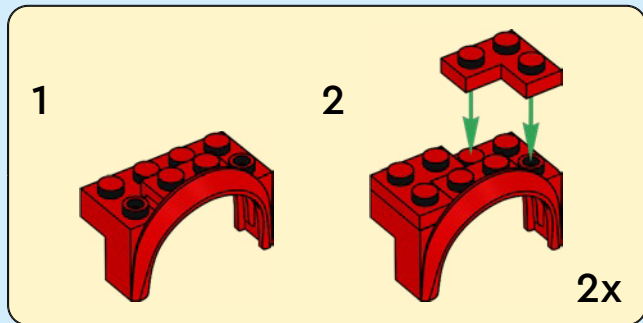



2x



2x

46

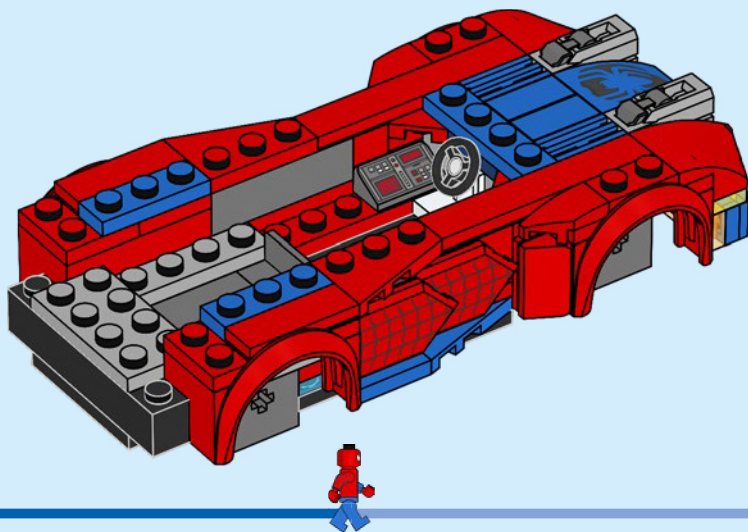



2x



2x

47

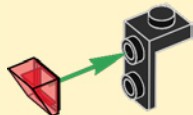

2x

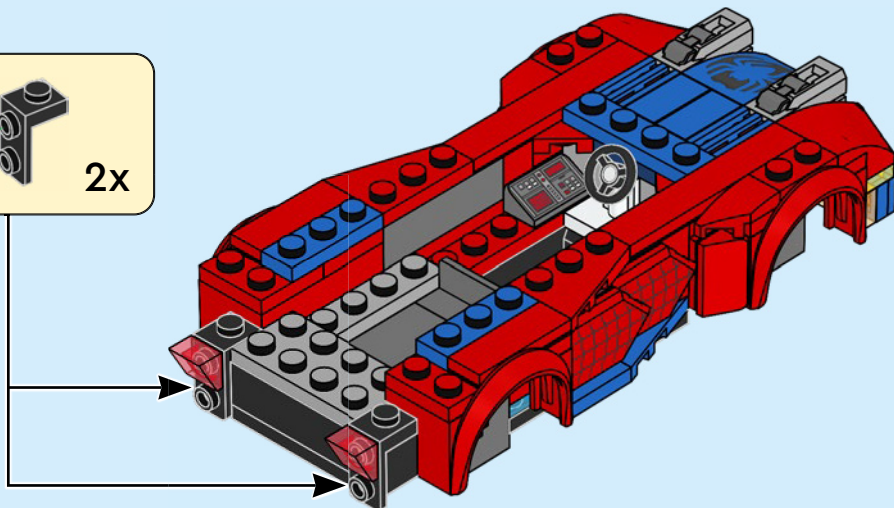



2x



1x

48

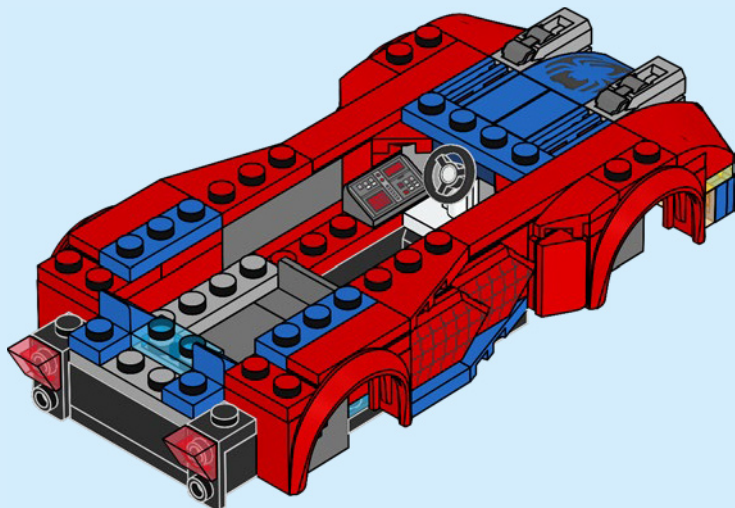

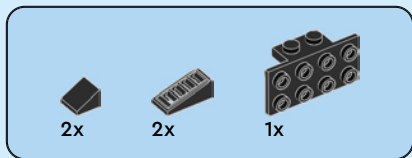

49

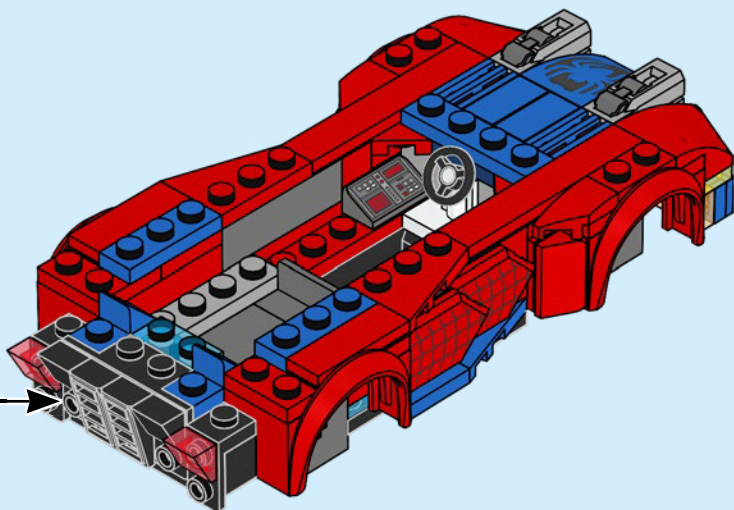
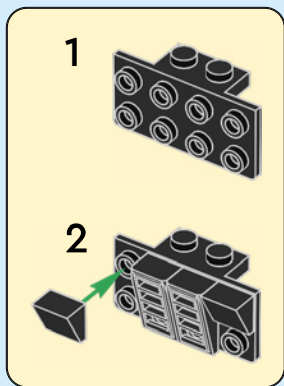



50

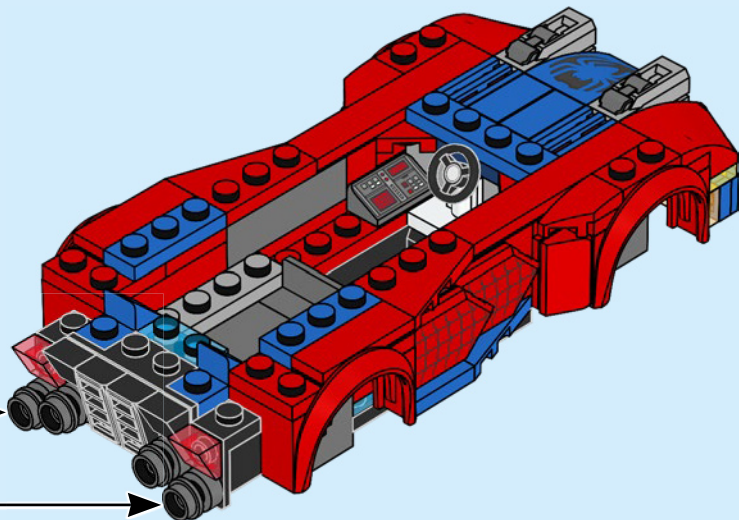
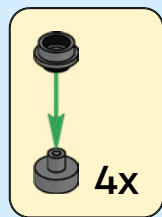



2x

51

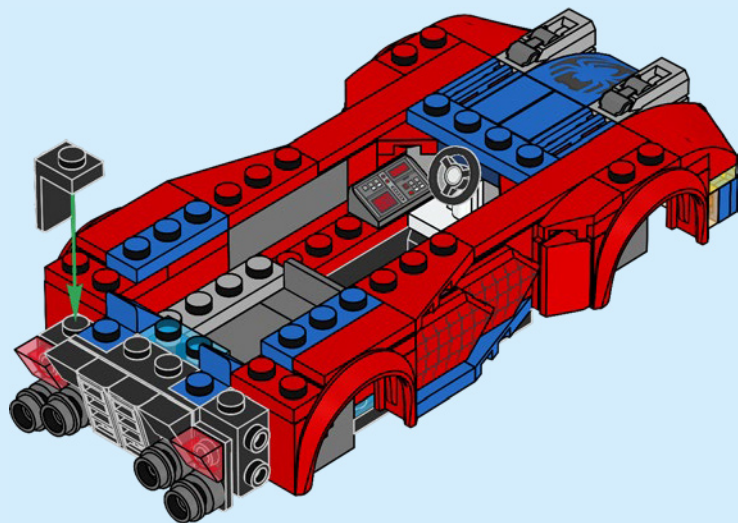



2x



2x

52

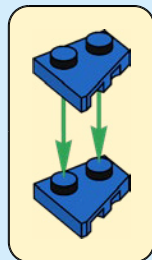
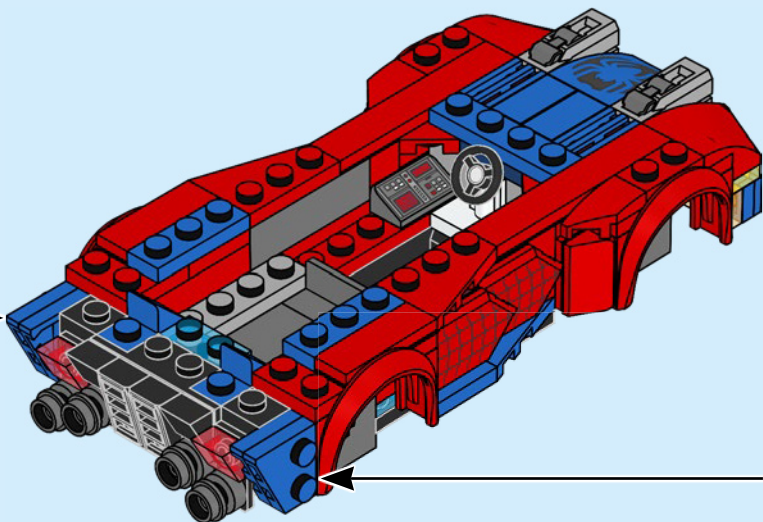
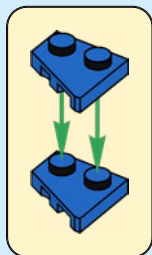

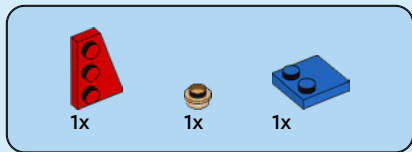

53

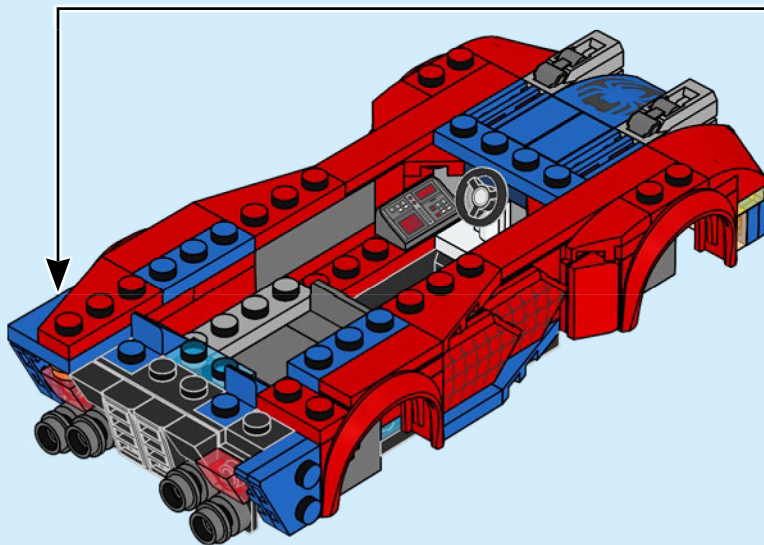
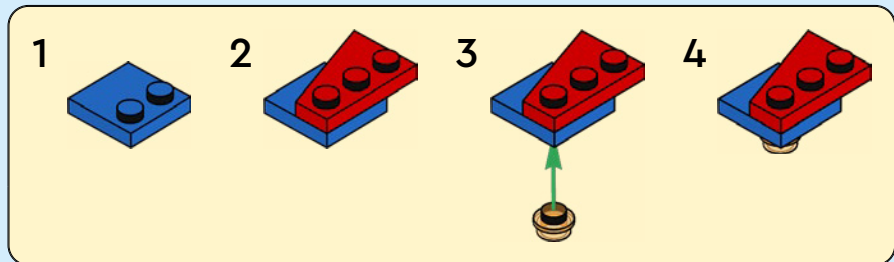

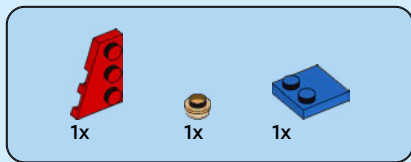

54

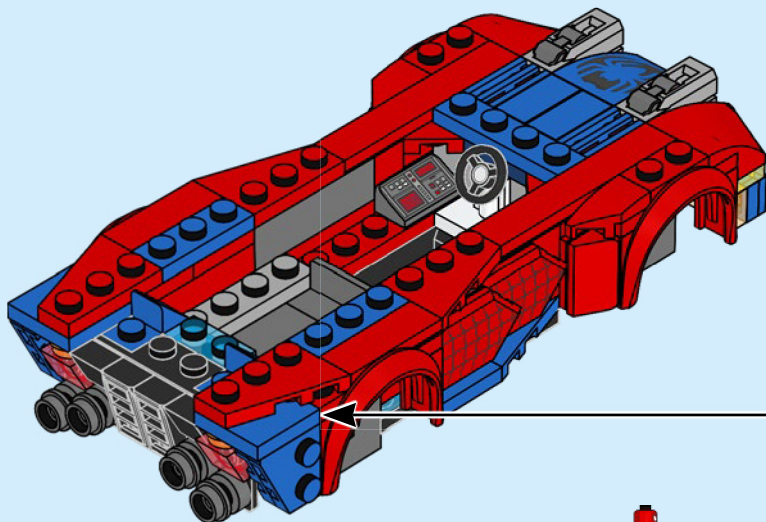
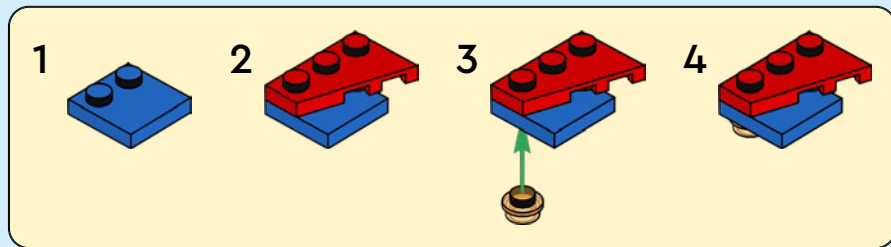

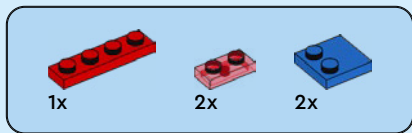

55

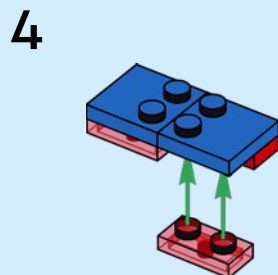
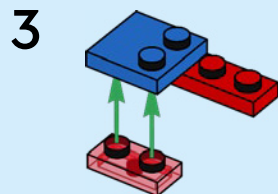
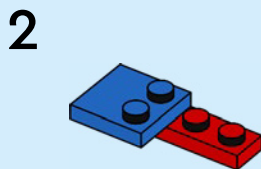
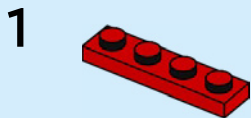

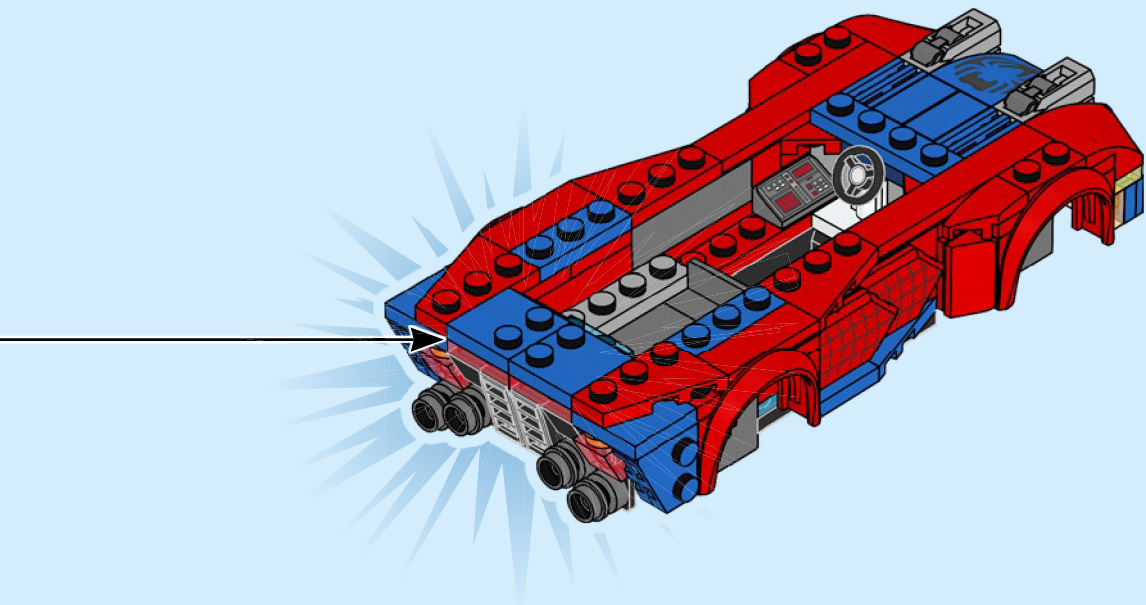



2x

56

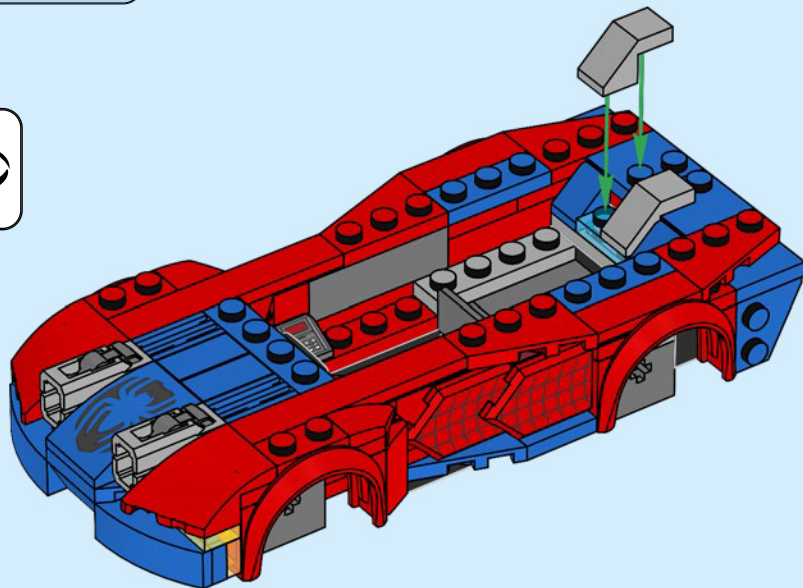
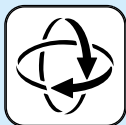

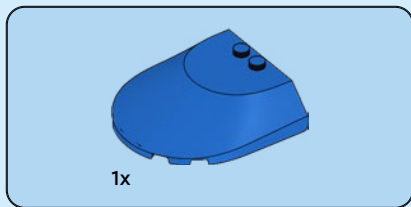

57

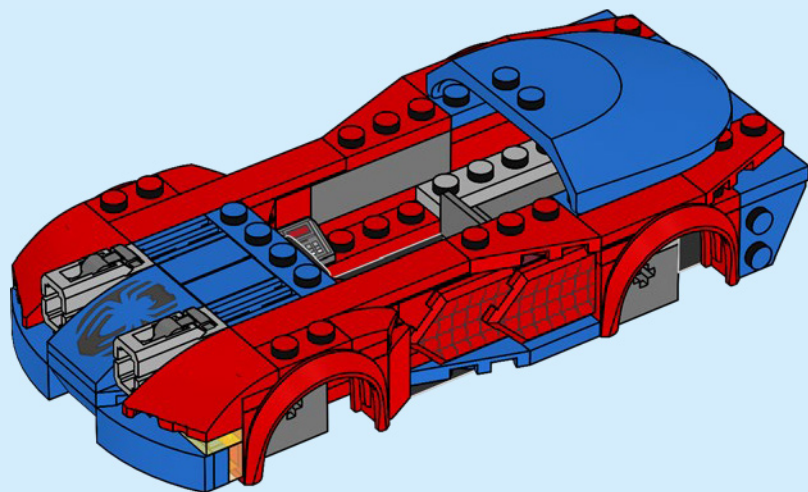

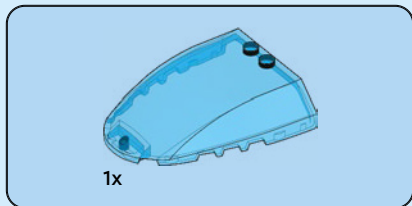

58

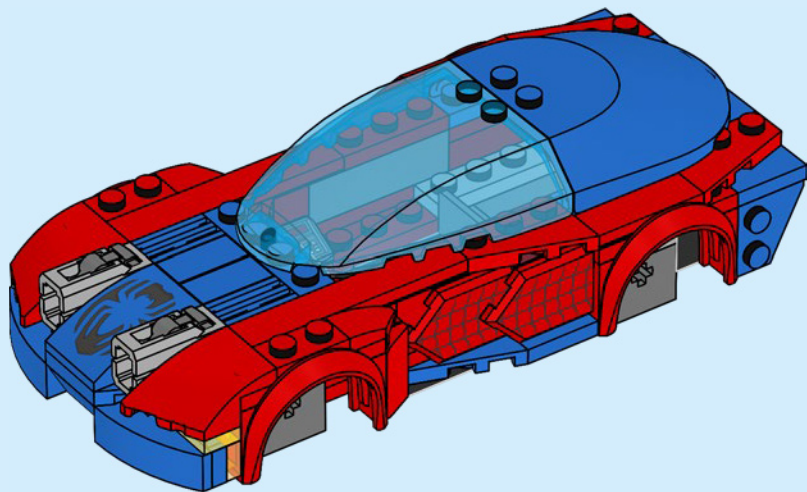



59

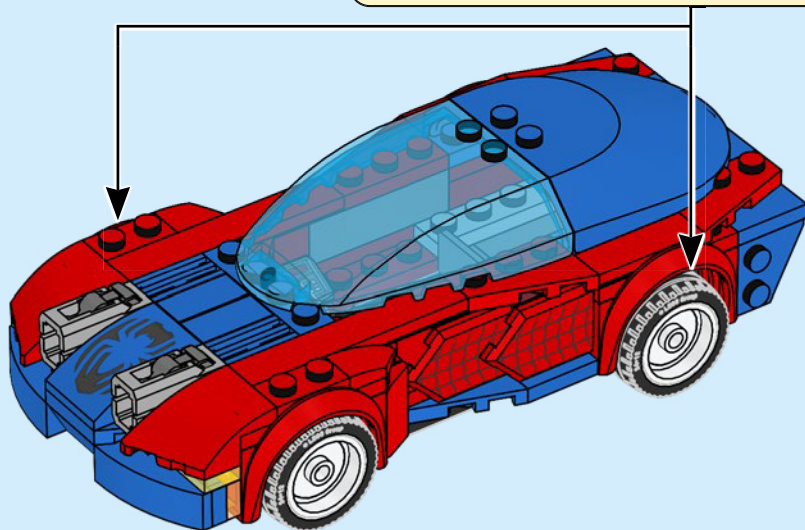
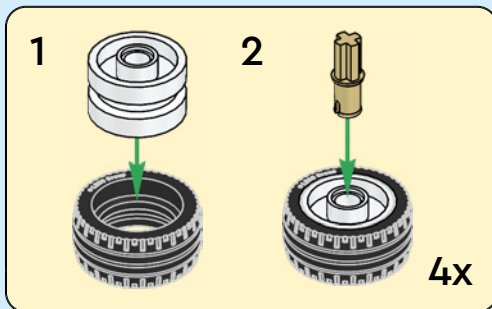



4x



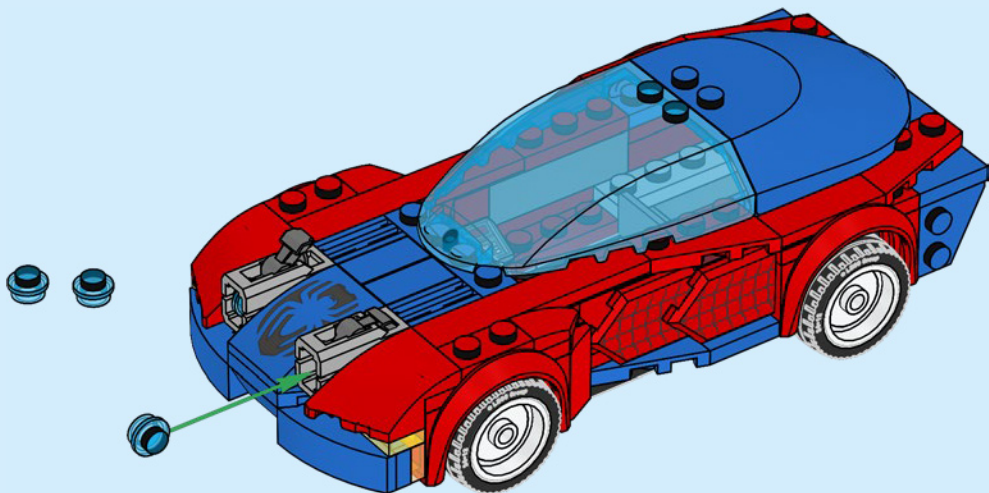

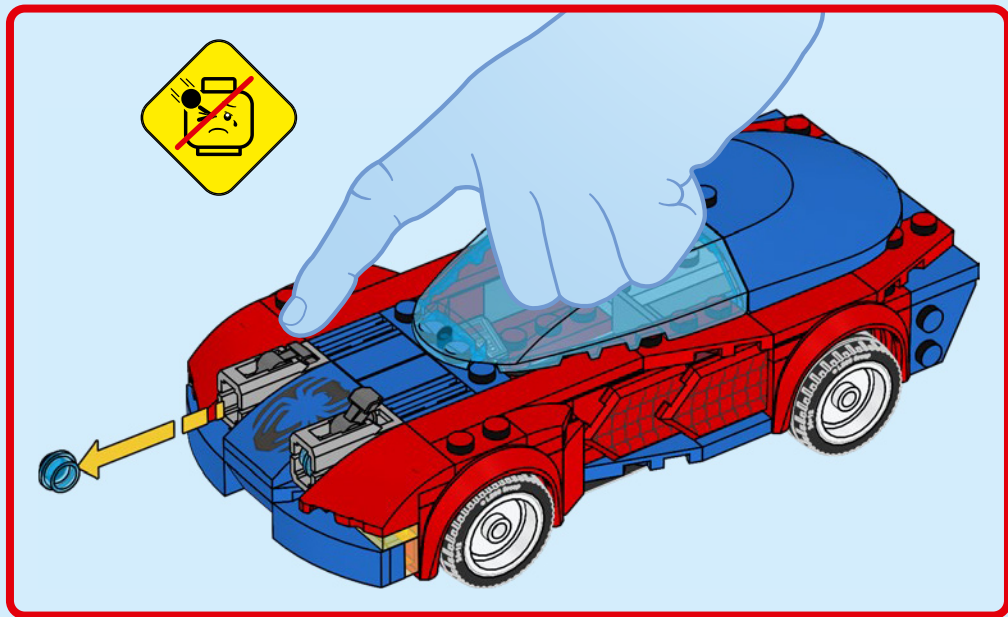

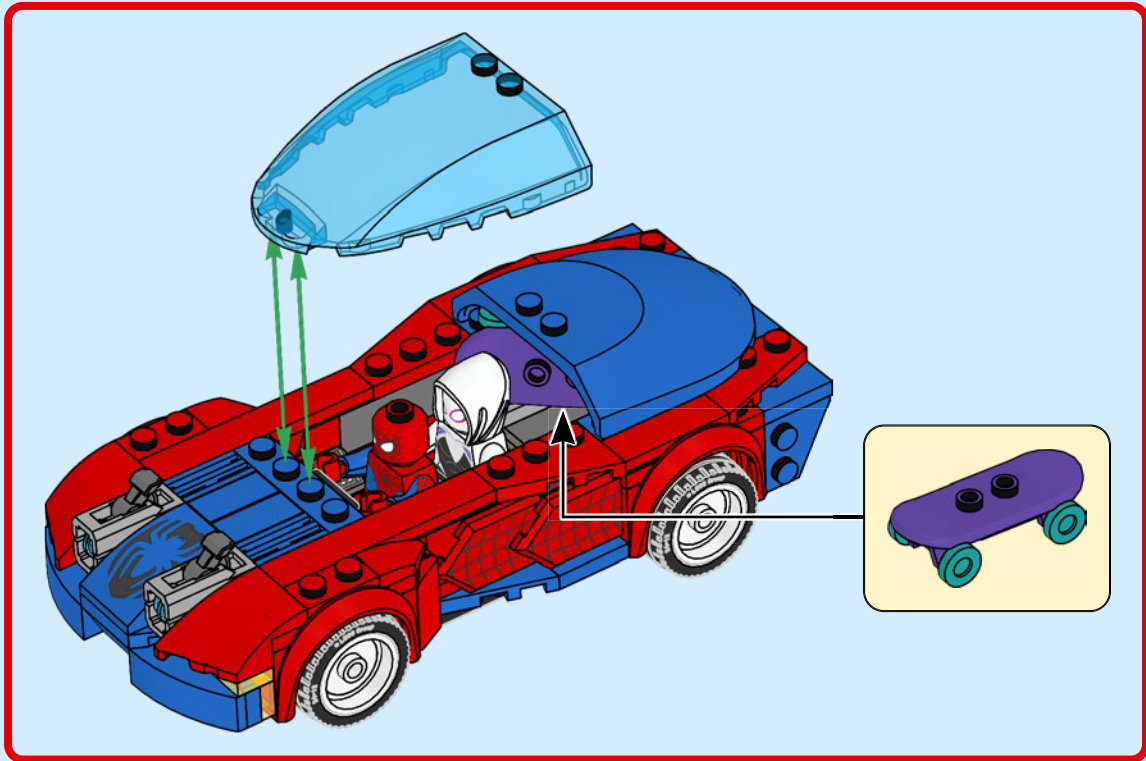

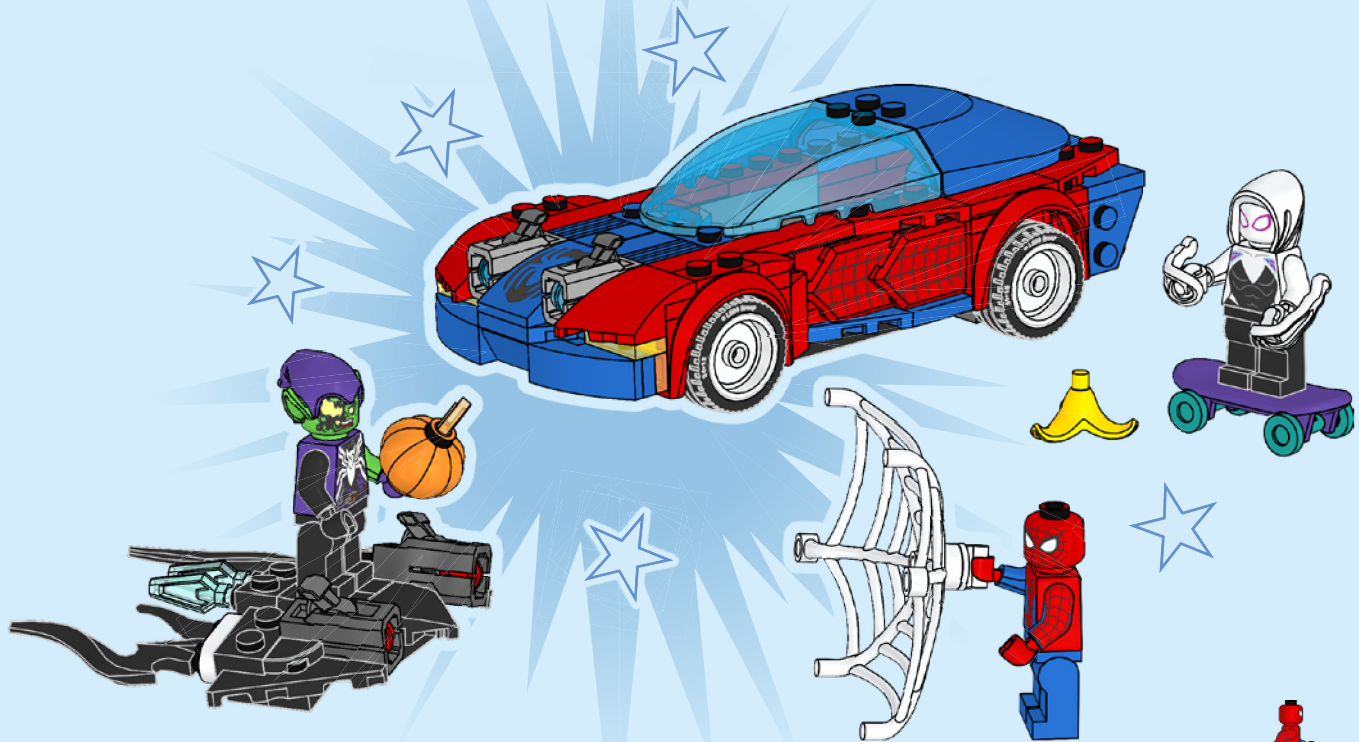















































60









 4x 614121	 2x 6451524	 1x 371021	 1x 6403442	 1x 6295295	 1x 6308912	 4x 6102596
 1x 6329750	 6x 302321	 4x 6441691	 1x 6476251	 1x 6295293	 2x 6092585	 1x 6118829
 2x 300521	 2x 6173961	 2x 366621	 1x 6174272	 2x 6172383	 2x 4541191	 1x 301026
 2x 302421	 4x 242021	 2x 4113858	 2x 6213378	 2x 4504382	 2x 6016172	 1x 302026
 1x 6177505	 1x 6436413	 2x 303421	 2x 6360382	 4x 6380236	 4x 6336989	 1x 4243819
 2x 6435047	 4x 6467557	 2x 4533742	 3x 4211395	 2x 6114248	 2x 6312496	 1x 4181144
 2x 4180504	 2x 6331882	 2x 6240217	 1x 4211385	 2x 9339	 2x 242026	 1x 6469445
 2x 4180533	 1x 6331882	 2x 6240217			 1x 6469445	 1x 6170384
 1x 6177507	 1x 6436412				 2x 362326	



2x
6345952



4x
6231765



4x
6271752



4x
6360675



2x
6152814



1x
6146225



1x
6187008



2x
4210725



2x
6454959



1x
6467554



2x
6245252



2x
6240212



2x
6434368



2x
6421682



3x
6213777



2x
6338181

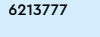

2x
4530028



5x
6485479



4x
4666579



2x
6240211



1x
6267125



2x
6185994



1x
6464535



4x
302423



2x
6189198



2x
6189202



1x
4498156



1x
4498155



1x
4651236



1x
9341



2x
241223



2x
6069163



2x
306923



6x
6252060



2x
362323



2x
4543998



1x
4609454



1x
6467556



3x
371023



1x
346023



1x
6468506



4x
6240214



4x
6240215



1x
6468505



1x
6168642



1x
6186681



2x
6451665



3x
6335278



1x
6252946



1x
6289866



3x
6210272



1x
9551



1x
383901



1x
6395608



1x
6252949



1x
6409728



4x
6290262

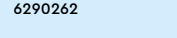

1x
6446002

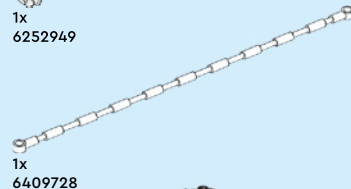

1x
6409728



LEGO.com/service



YOU COULD **WIN**

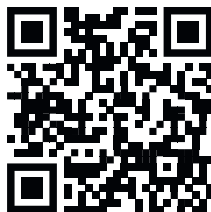

Scan this QR code or go to **LEGO.COM/PRODUCTFEEDBACK** and give us your short feedback about this LEGO® set for a chance to win a cool LEGO prize.

Terms and Conditions apply*



EN: YOU COULD WIN. Terms and Conditions apply* **DE: Du könntest GEWINNEN.** Es gelten die Teilnahmebedingungen* **FR: Tu pourrais GAGNER.** Des conditions s'appliquent* **IT: Potresti VINCERE tu.** Termini e condizioni sono applicabili* **ES: Puedes GANAR.** Aplican términos y condiciones* **PT: Poderá GANHAR.** Aplicam-se termos e condições* **ZH: 轻松获奖. 条款和条件适用*** **PL: Szansa na WYGRANĄ.** Obowiązują warunki korzystania* **CS: Máte šanci VYHRÁT.** Platí všeobecné smluvní podmínky* **SK: Máte šancu VYHRAŤ.** Platia všeobecné zmluvné podmienky* **HU: TE IS NYERHETSZ.** Felhasználási feltételek érvényesek* **RO: Ai putea CÂȘTIGA.** Se aplică termenii și condiții* **BG: Можете да СПЕЧЕЛИТЕ.** Има определени правила и условия* **LV: Tu vari LAIMĒT.** Ir spēkā noteikumi un nosacījumi.* **ET: Sul on võimalus VÕITA.** Kehtivad tingimused* **LT: Jūs galite LAIMĖTI.** Taikomos sąlygos*

*[LEGO.com/productfeedback-terms](https://www.lego.com/productfeedback-terms)