



# THE HOBBIT™

AN UNEXPECTED JOURNEY

79003





[LEGO.com/brickseparator](https://LEGO.com/brickseparator)

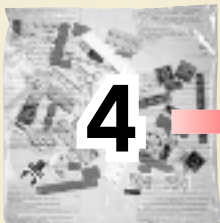
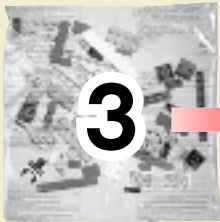
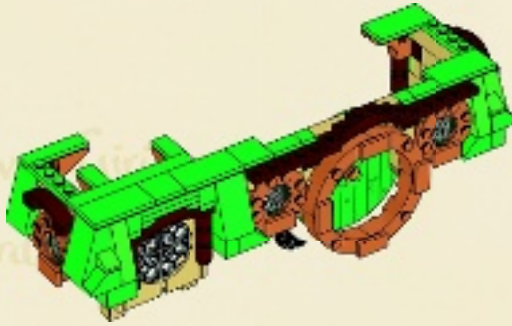
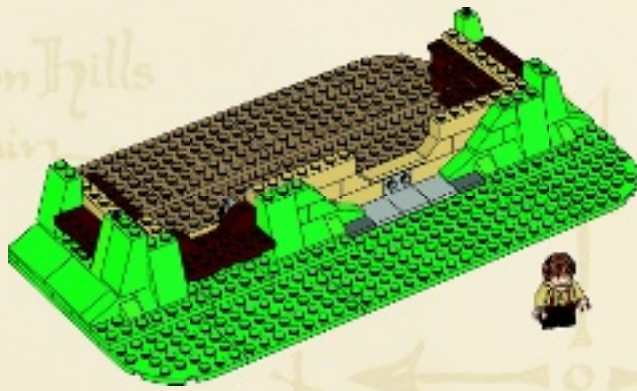
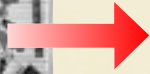

East lie the Iron Hills  
is Dain

Here we  
loran

the Running  
River

Here is  
the gateway  
of the Long  
Lake

The Desolation  
of Smaug

In Esgaroth upon  
the Long Lake  
dwell Men

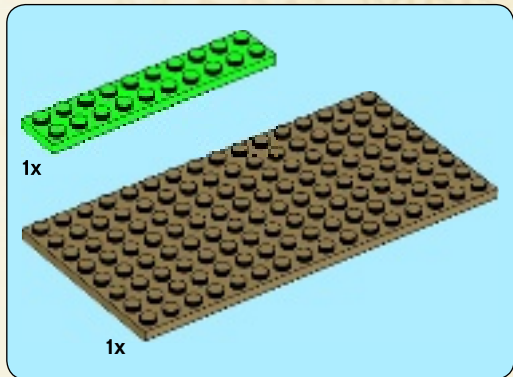
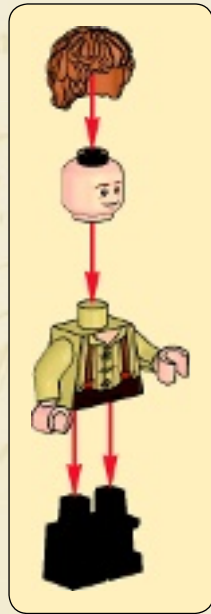
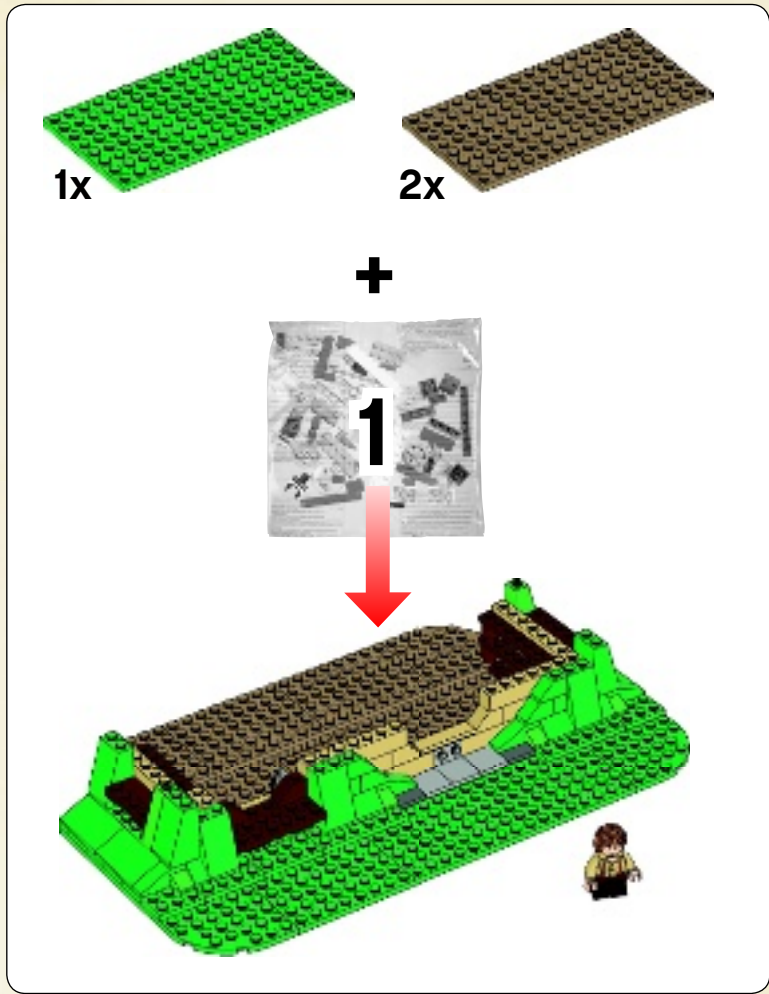

1

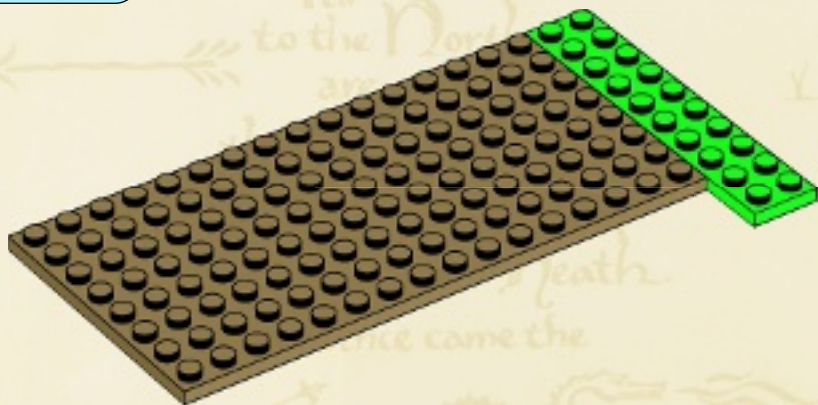

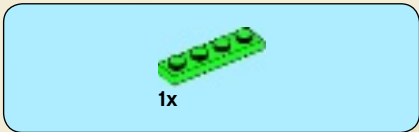

2

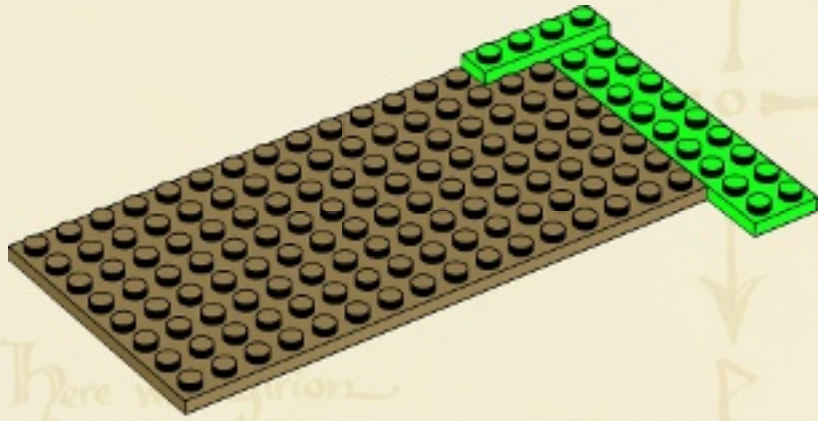

3

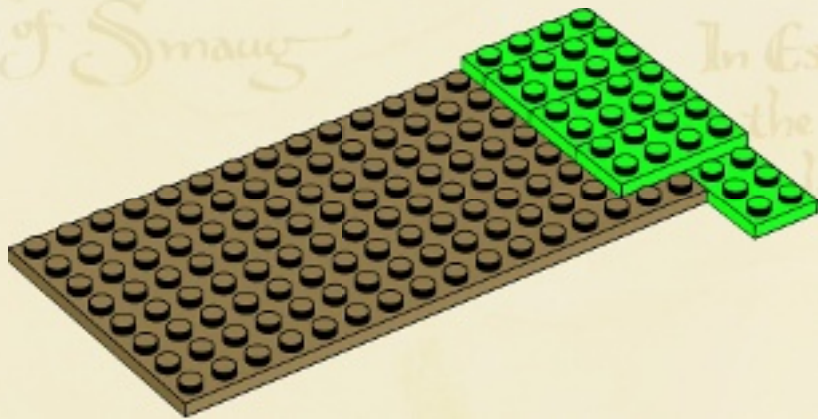



1x

4

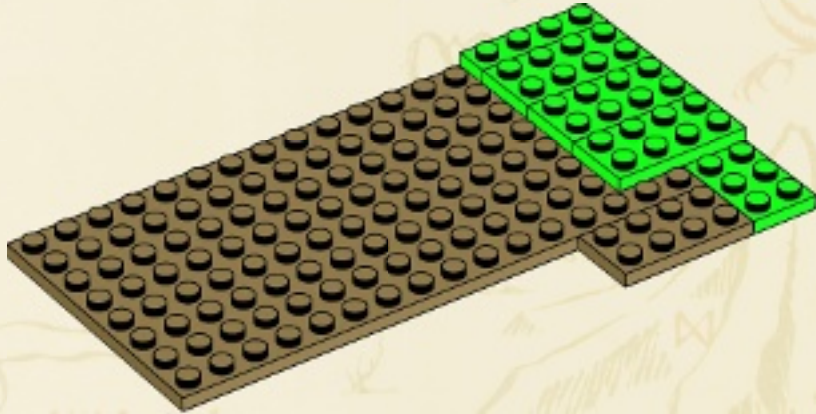

1x

5

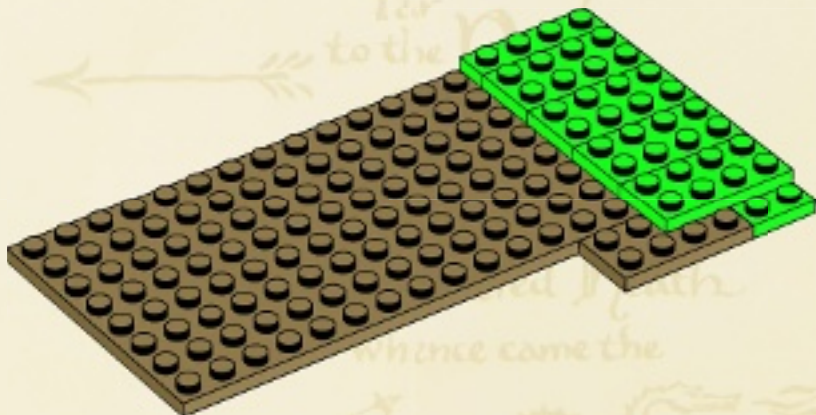

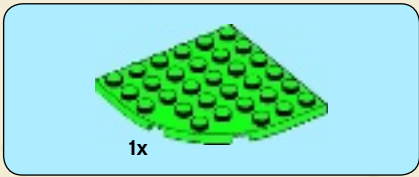

6

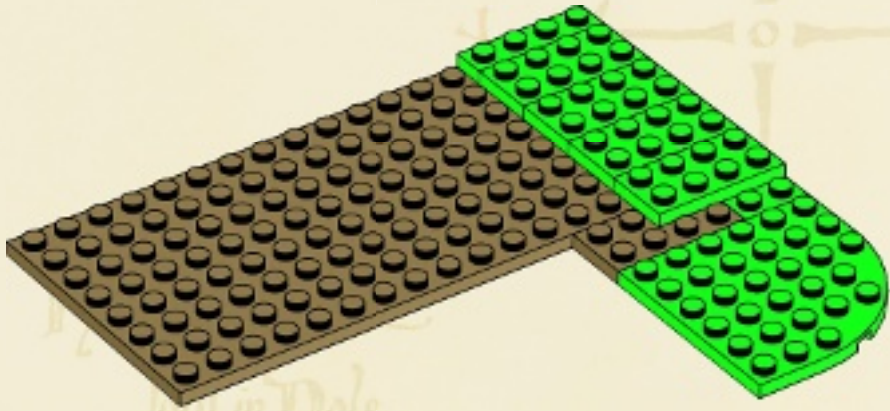

7

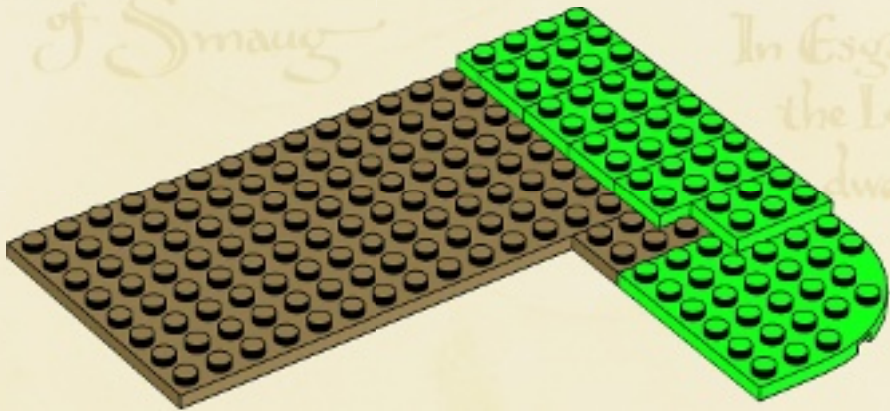

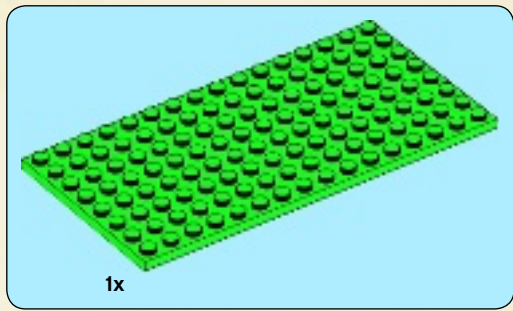

8

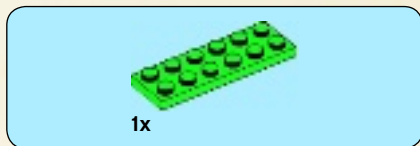
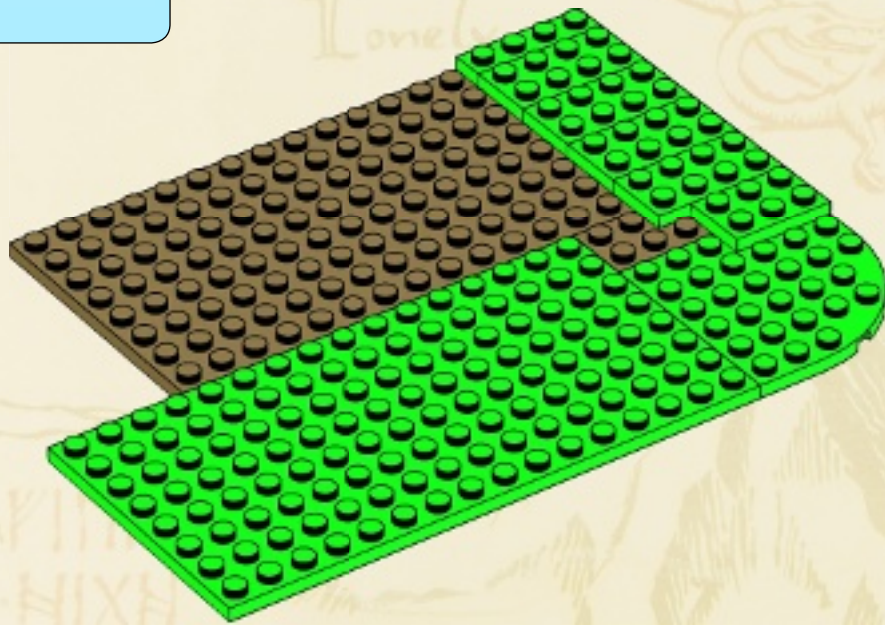

9

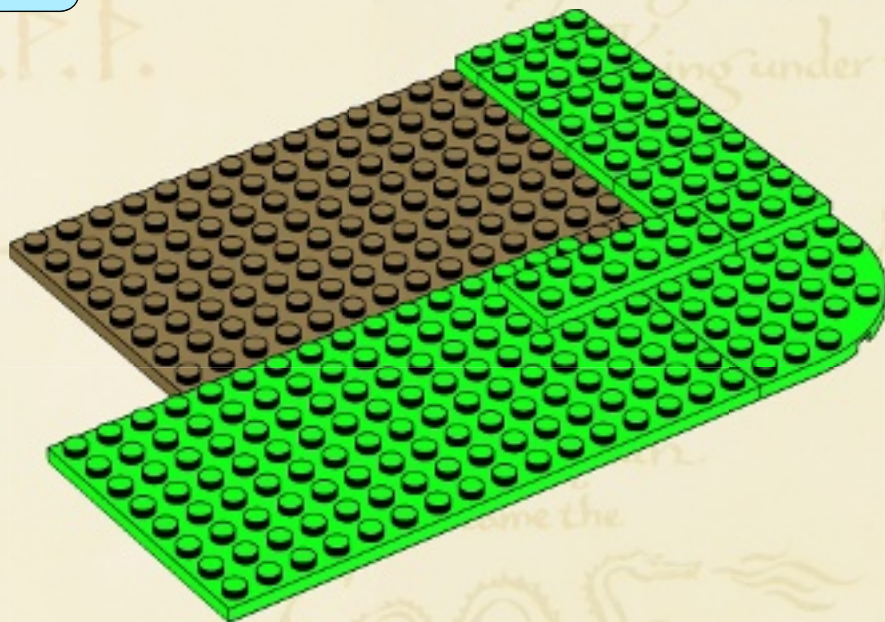



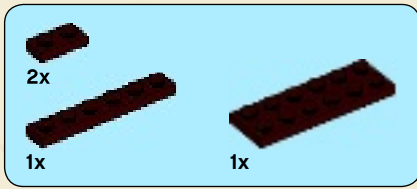

10

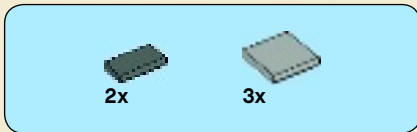
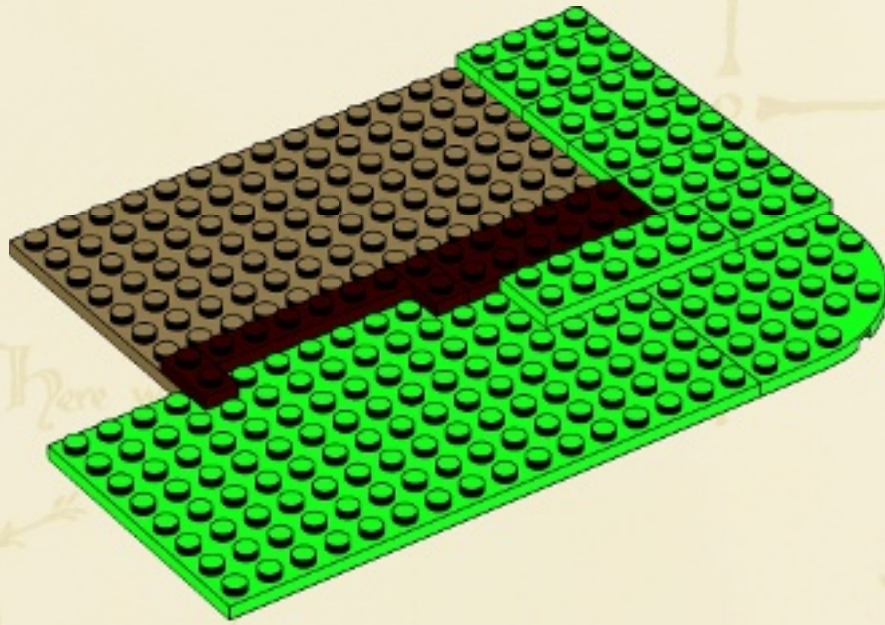

11

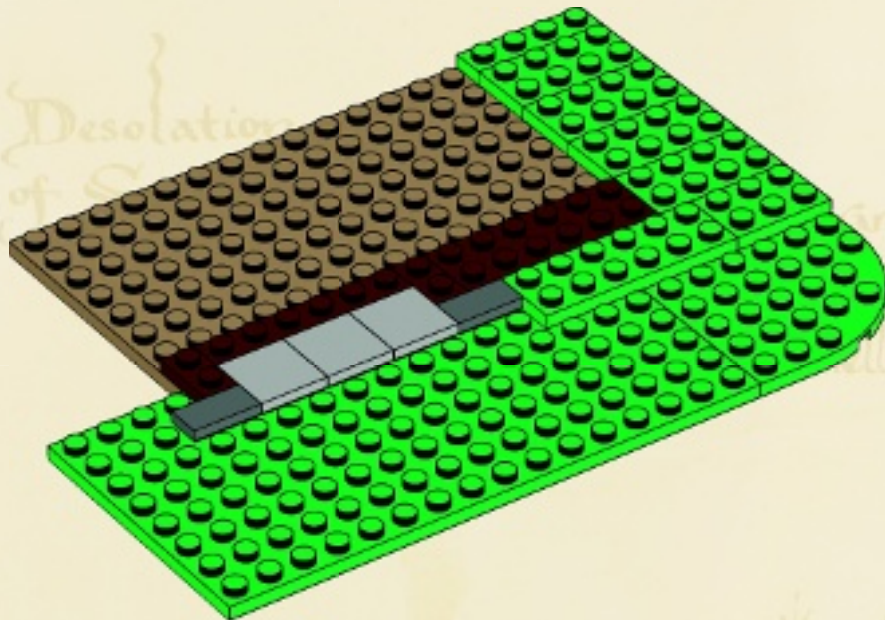

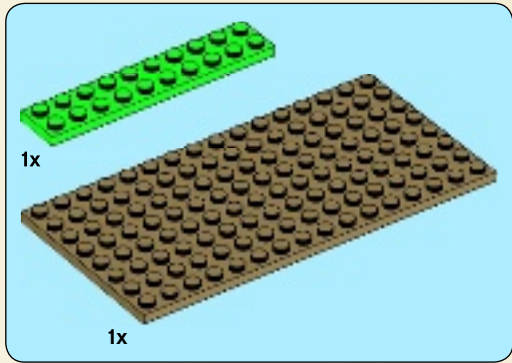
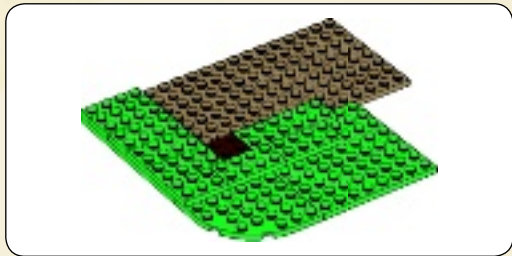

1

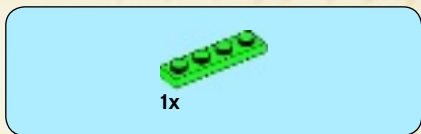
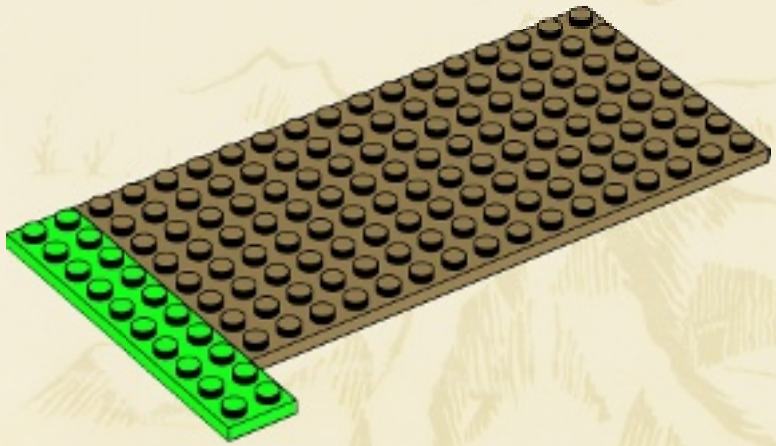

2

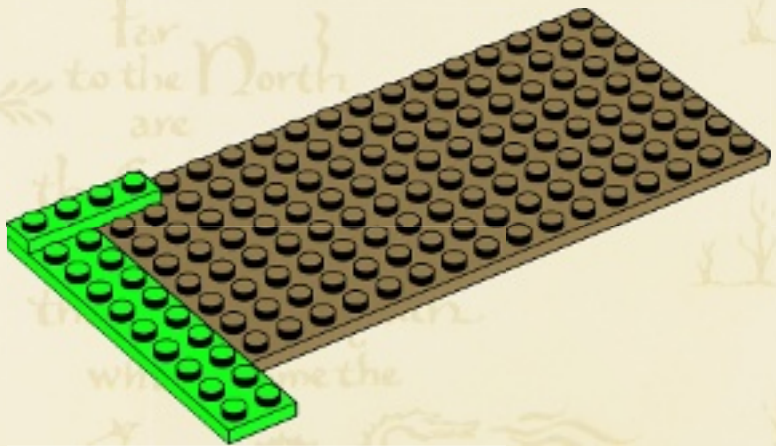



3

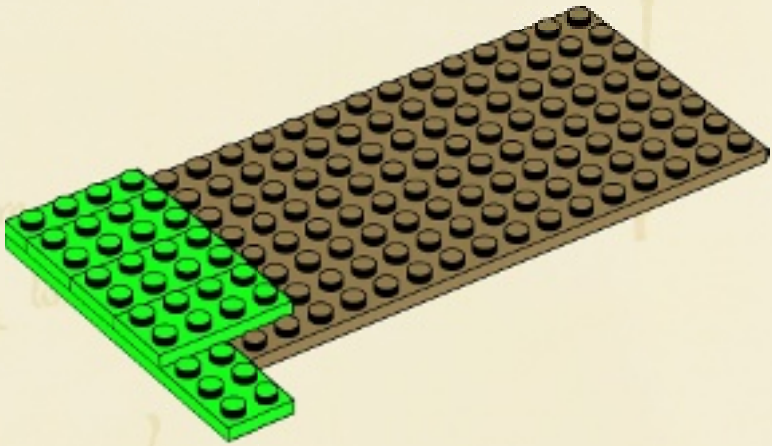

4

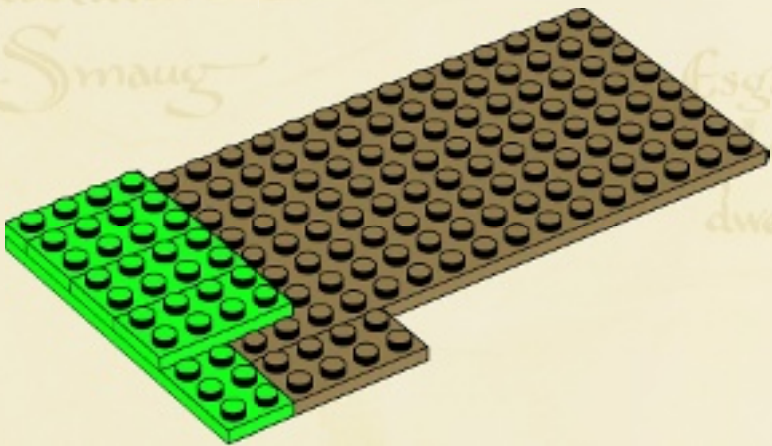



5

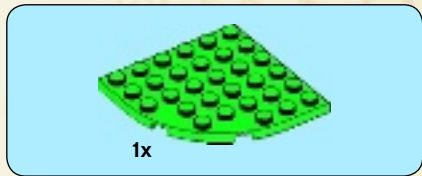
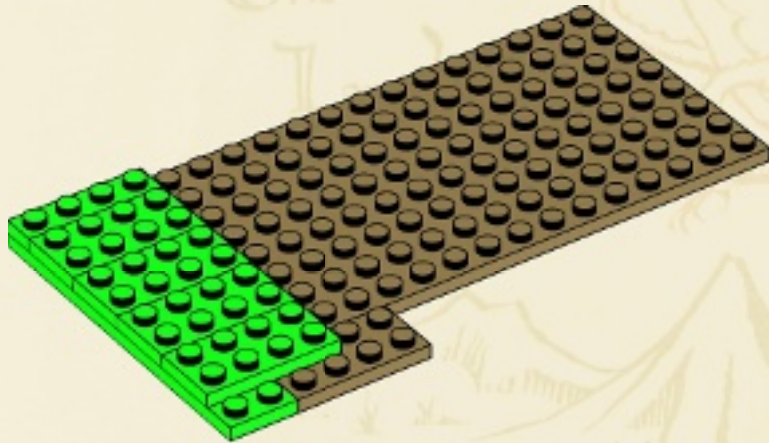

6

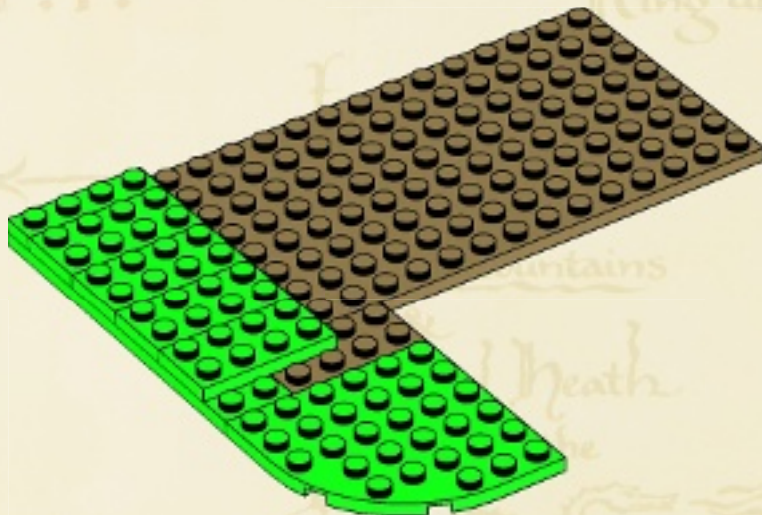



7

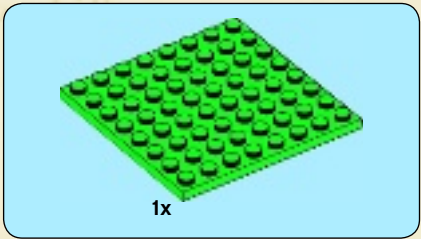
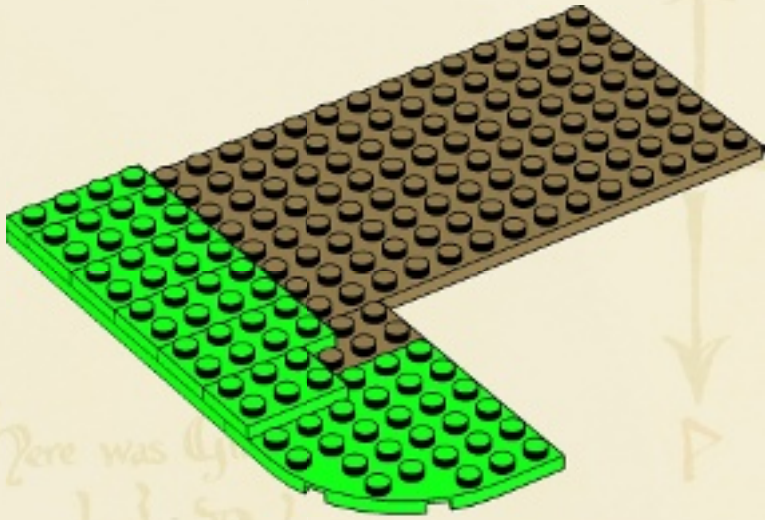

8

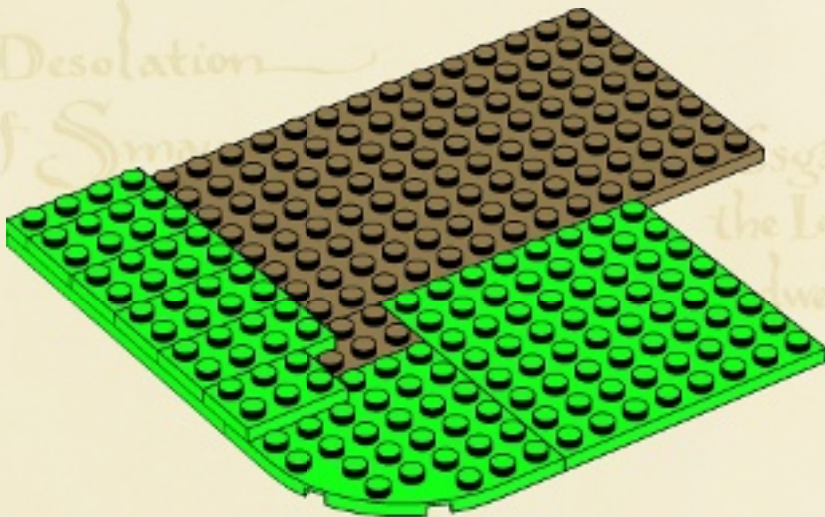



9

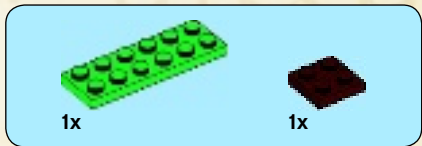
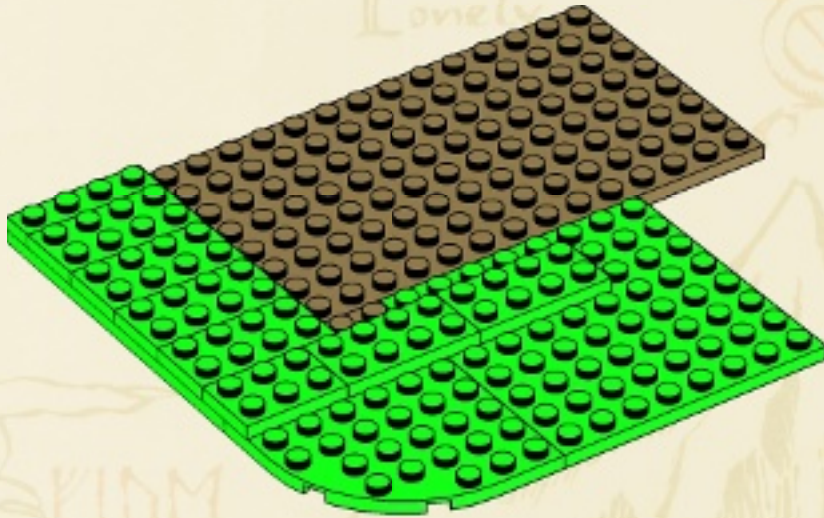

10

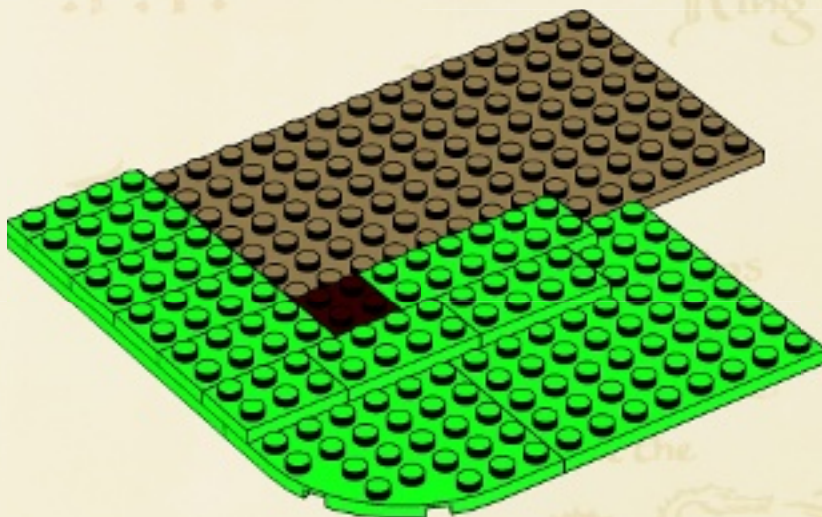

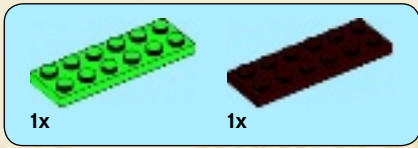

11

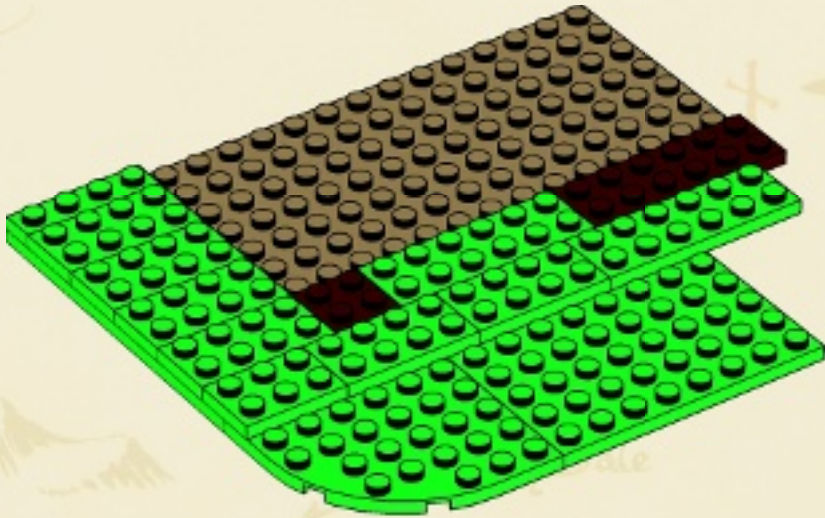

12

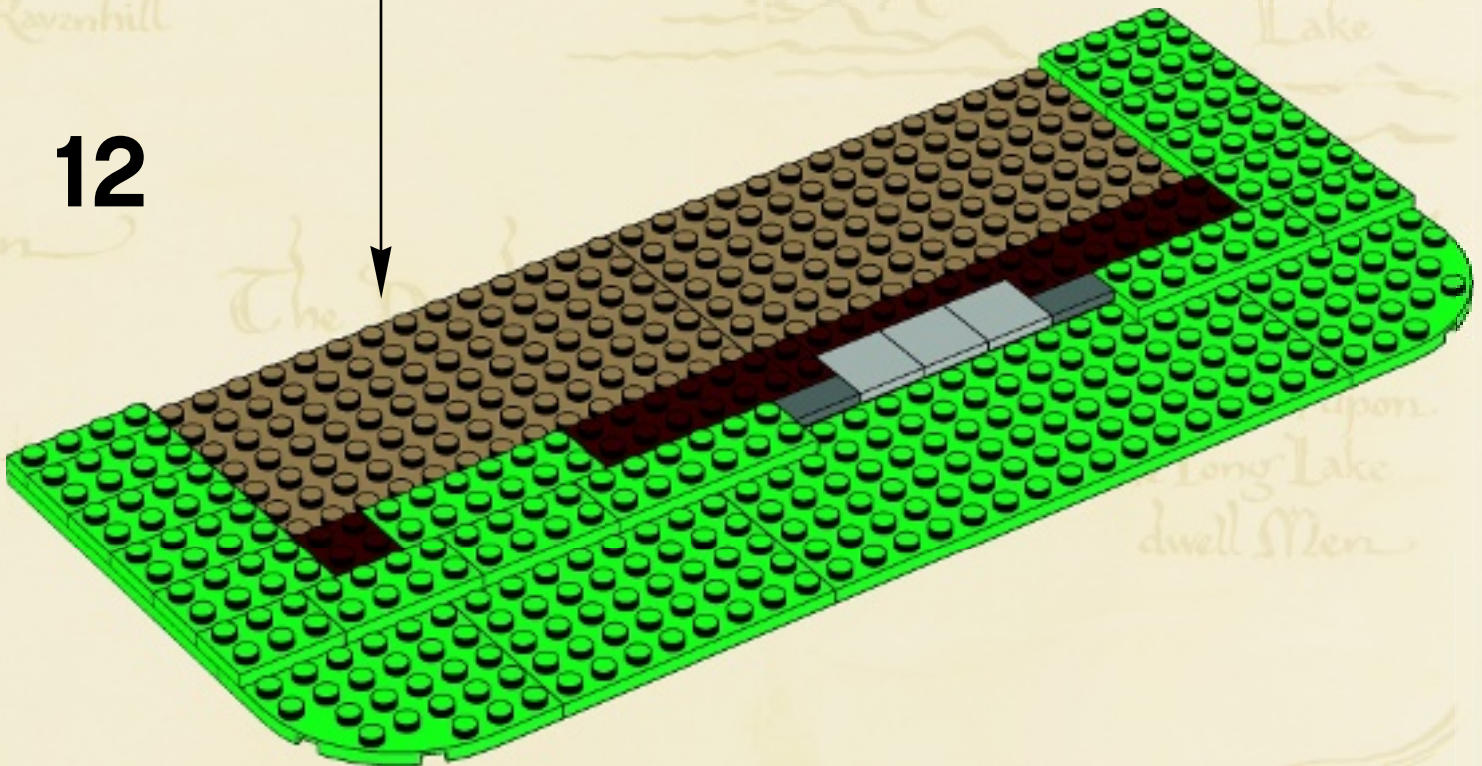

2x

13

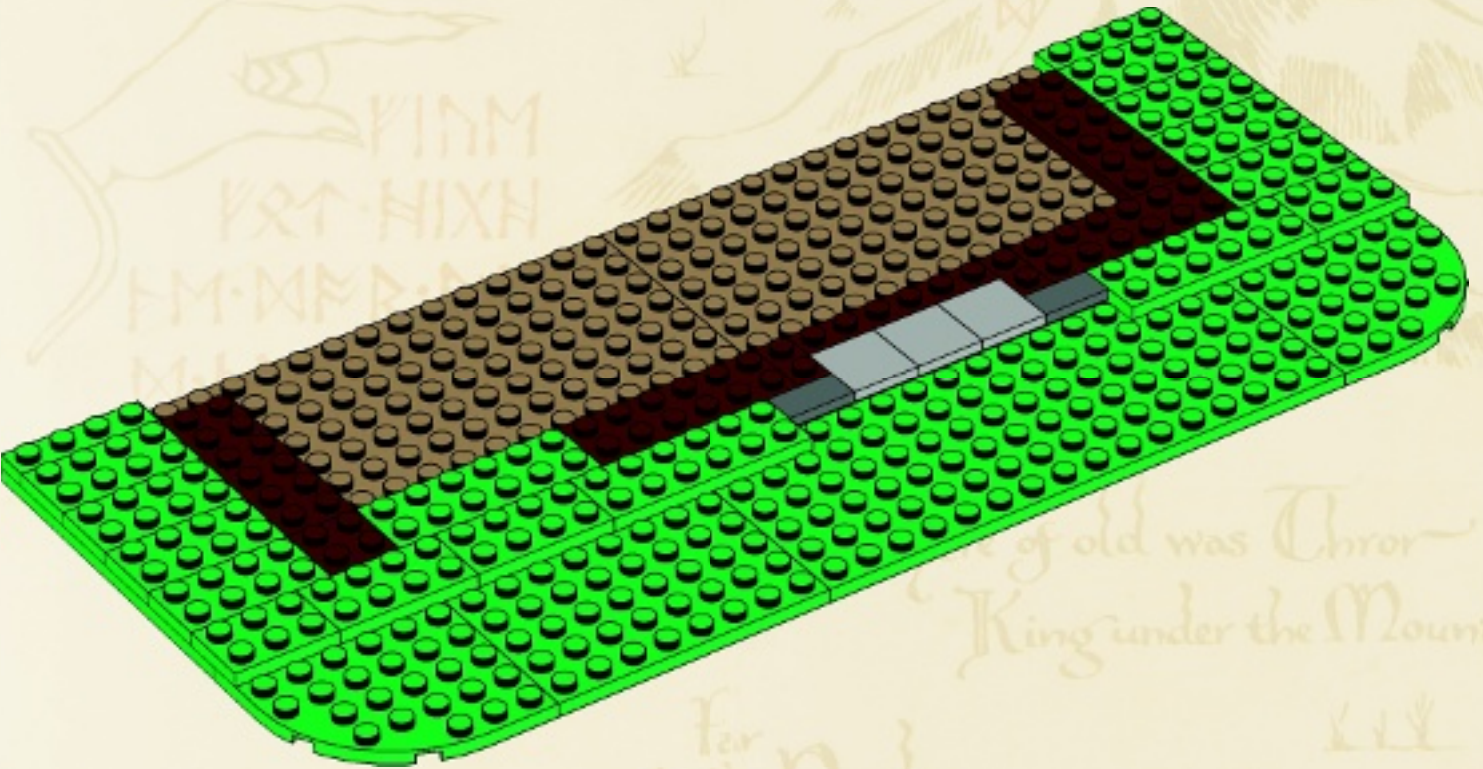

The  
Lonely  
Mountain

of old was Thror  
King under the Mountain

Far  
to the North  
are  
the Grey Mountains  
&  
the Withered Heath  
whence came the



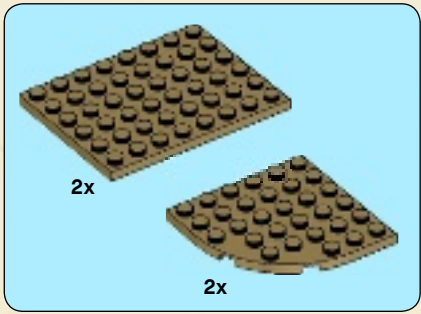

14

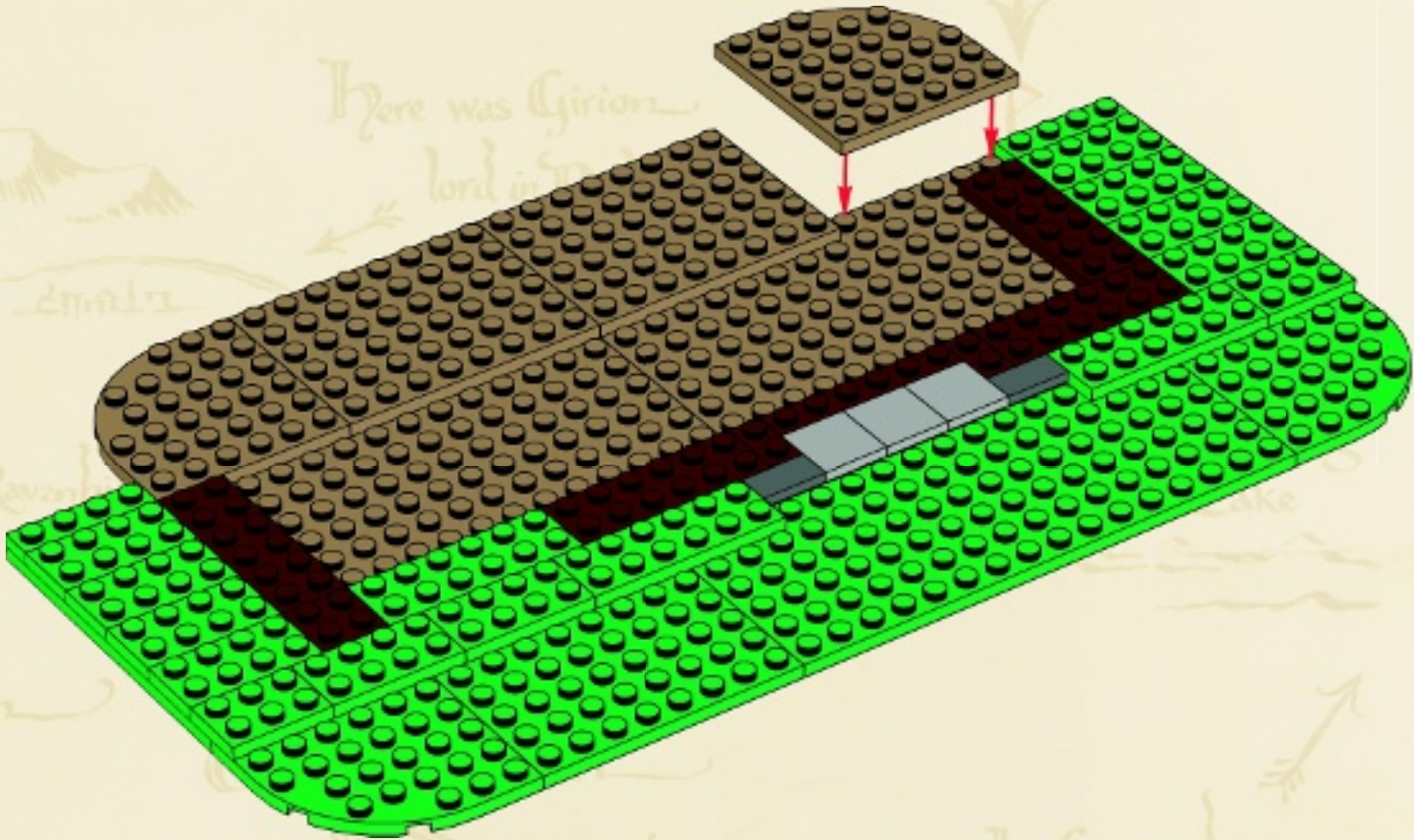



3x

15

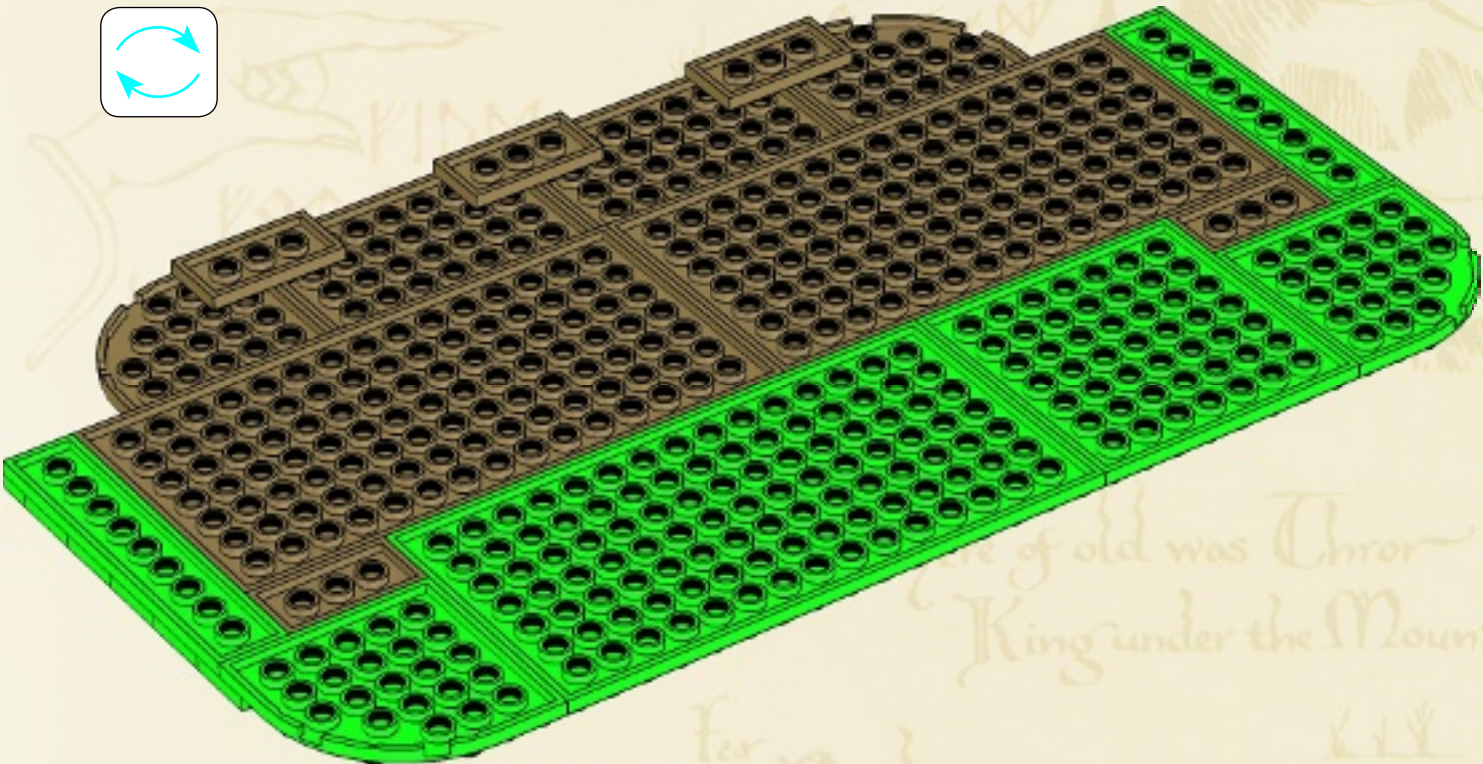
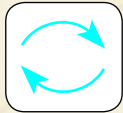

The  
Lonely  
Mountain

... of old was Thror  
King under the Mountain

Far  
to the North  
are  
the Grey Mountains  
&  
the Withered Heath  
whence came the



16

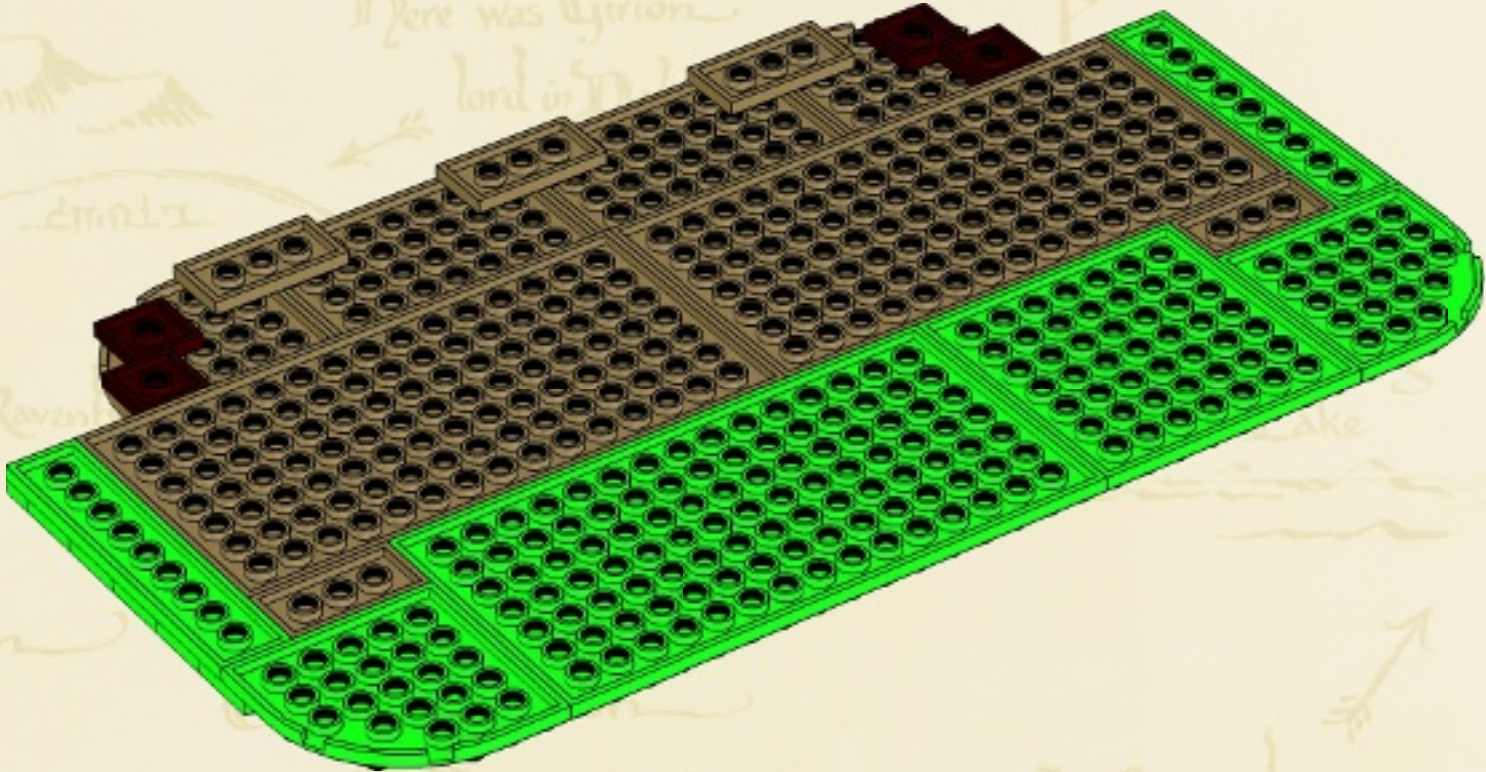

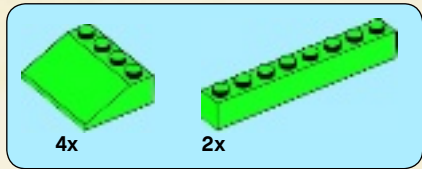

17

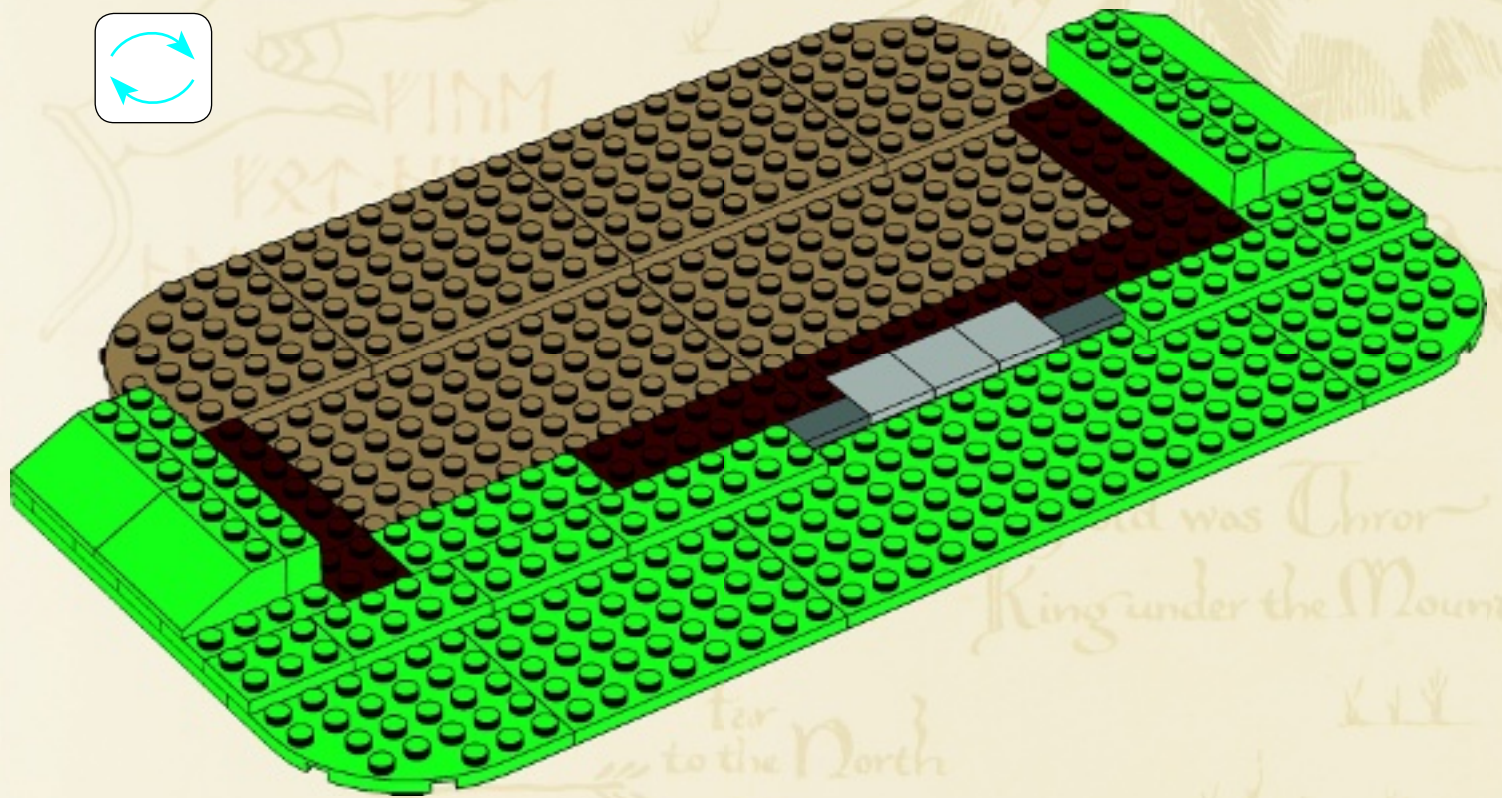
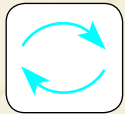



18

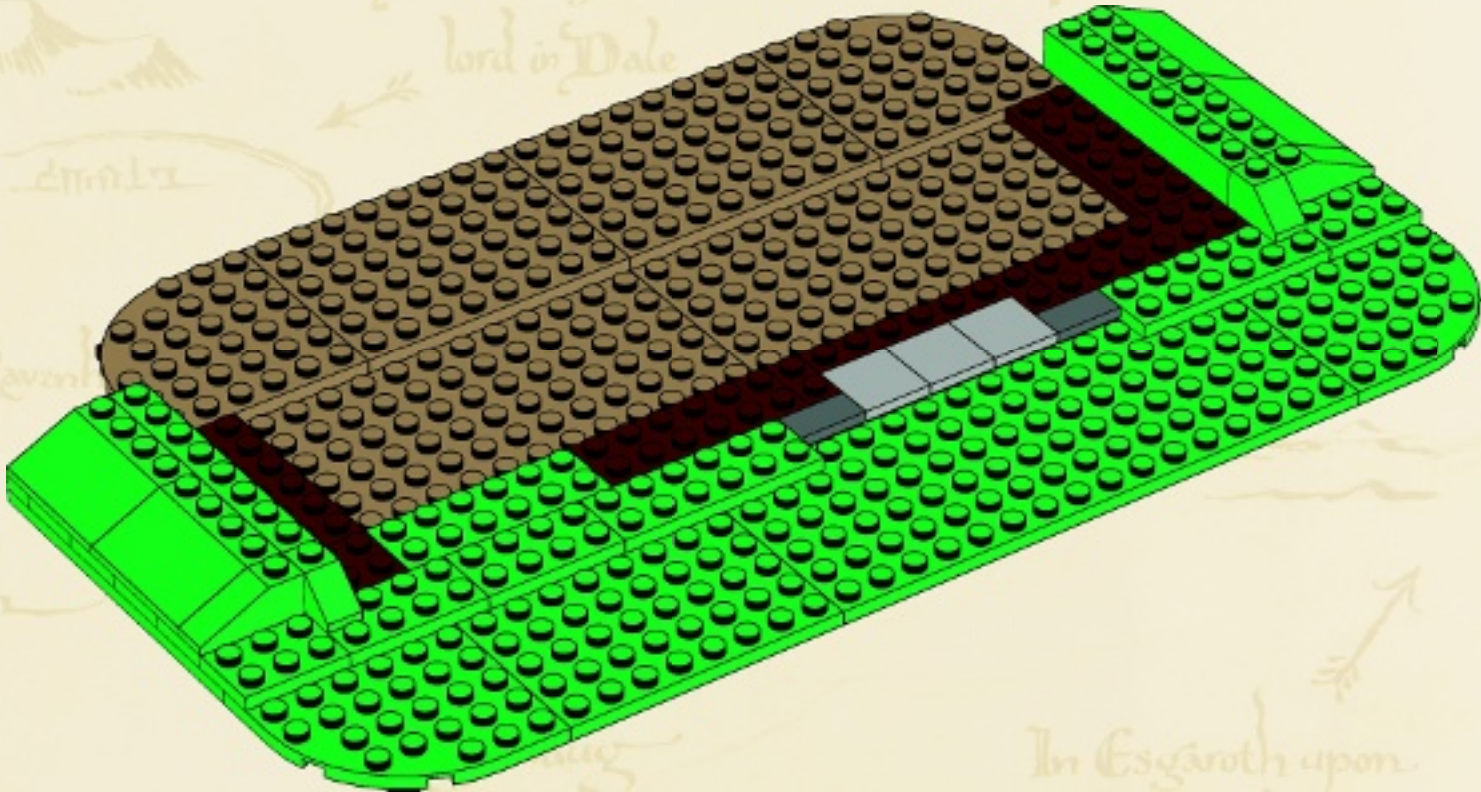

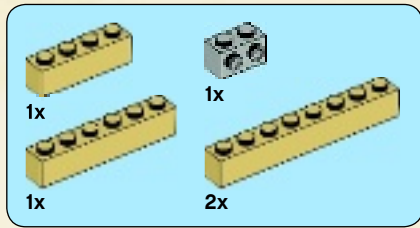

19

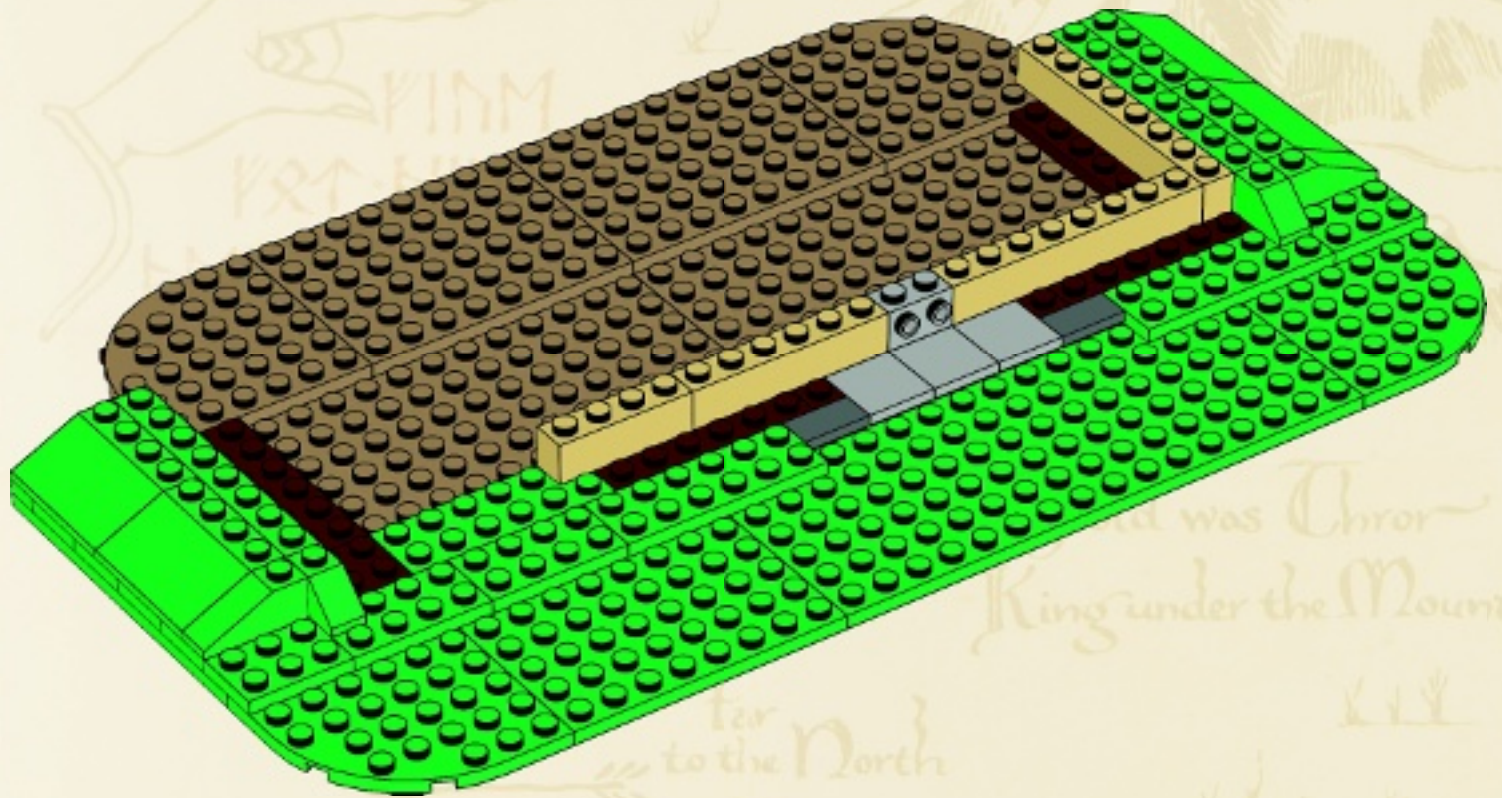

Far to the North  
are  
the Grey Mountains  
&  
the Withered Heath  
whence came the

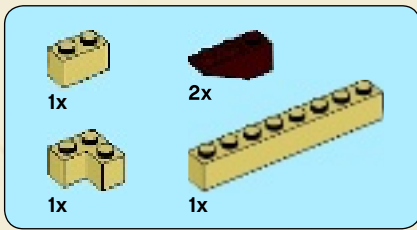

20

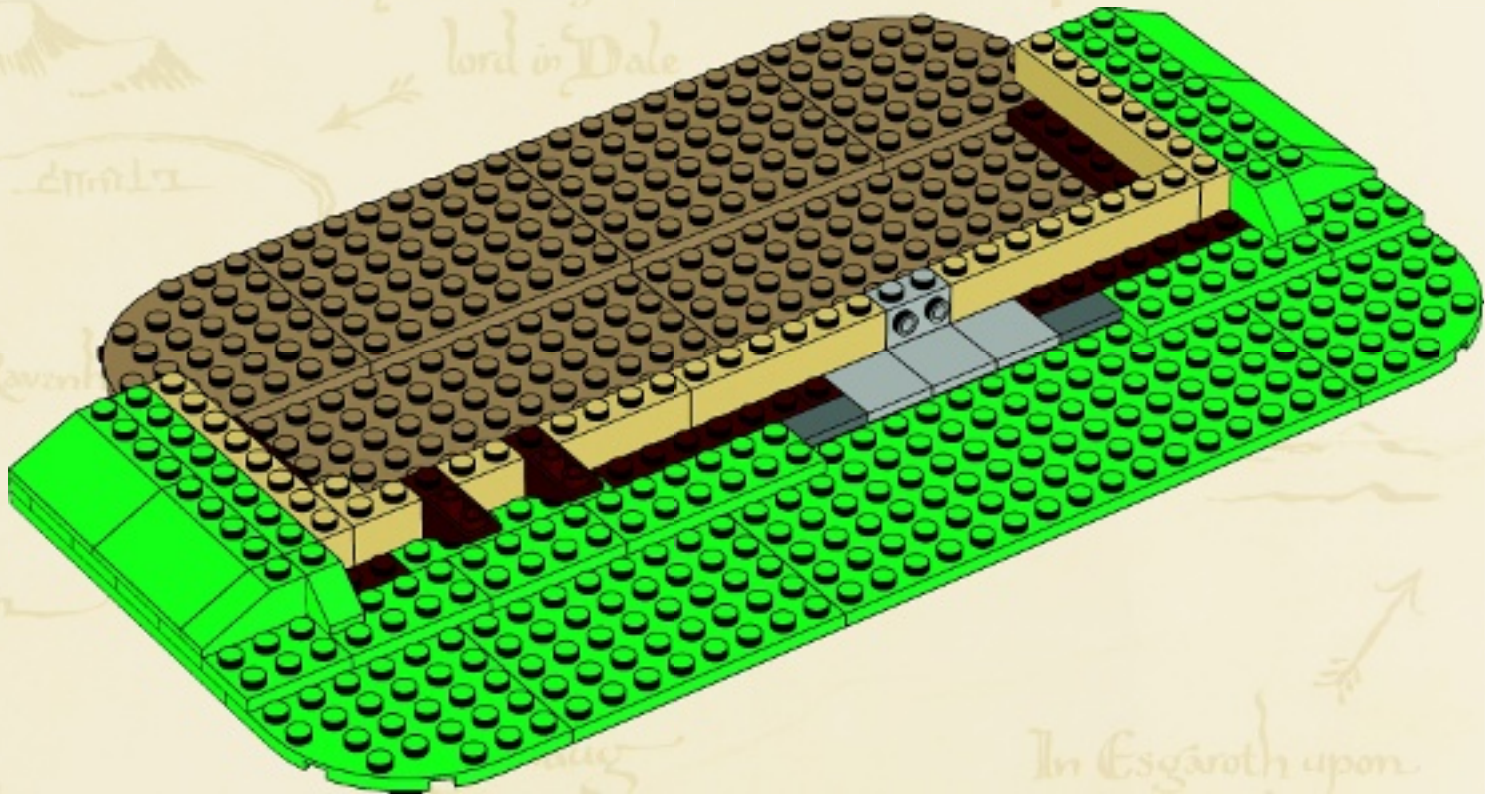

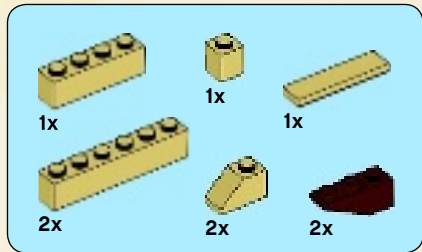

21

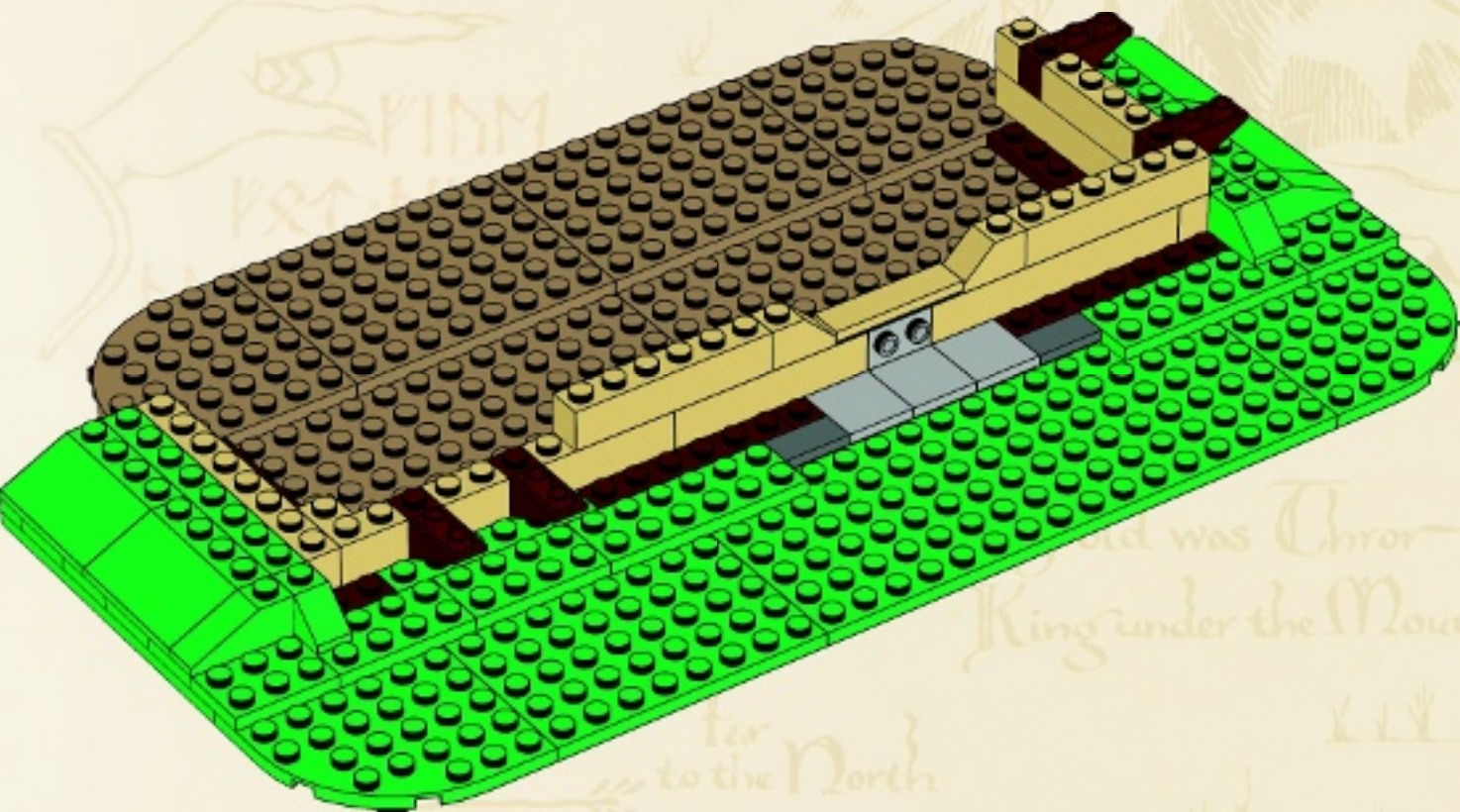



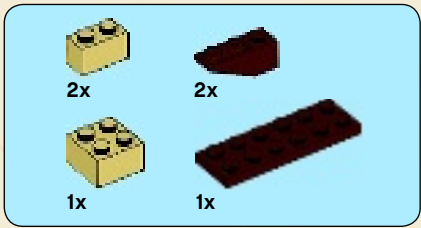

22

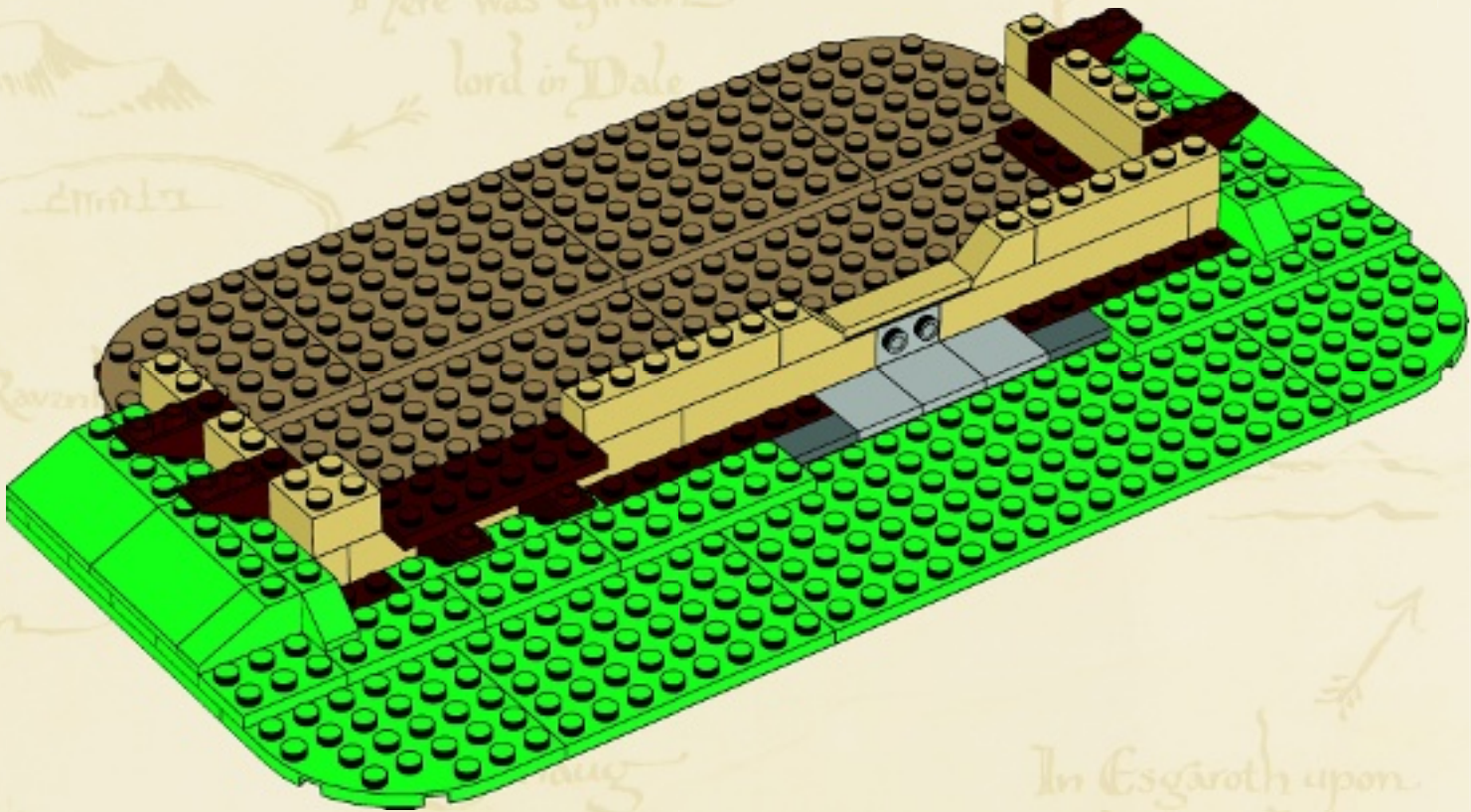

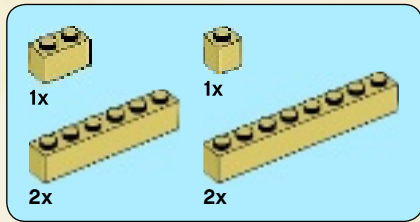

23

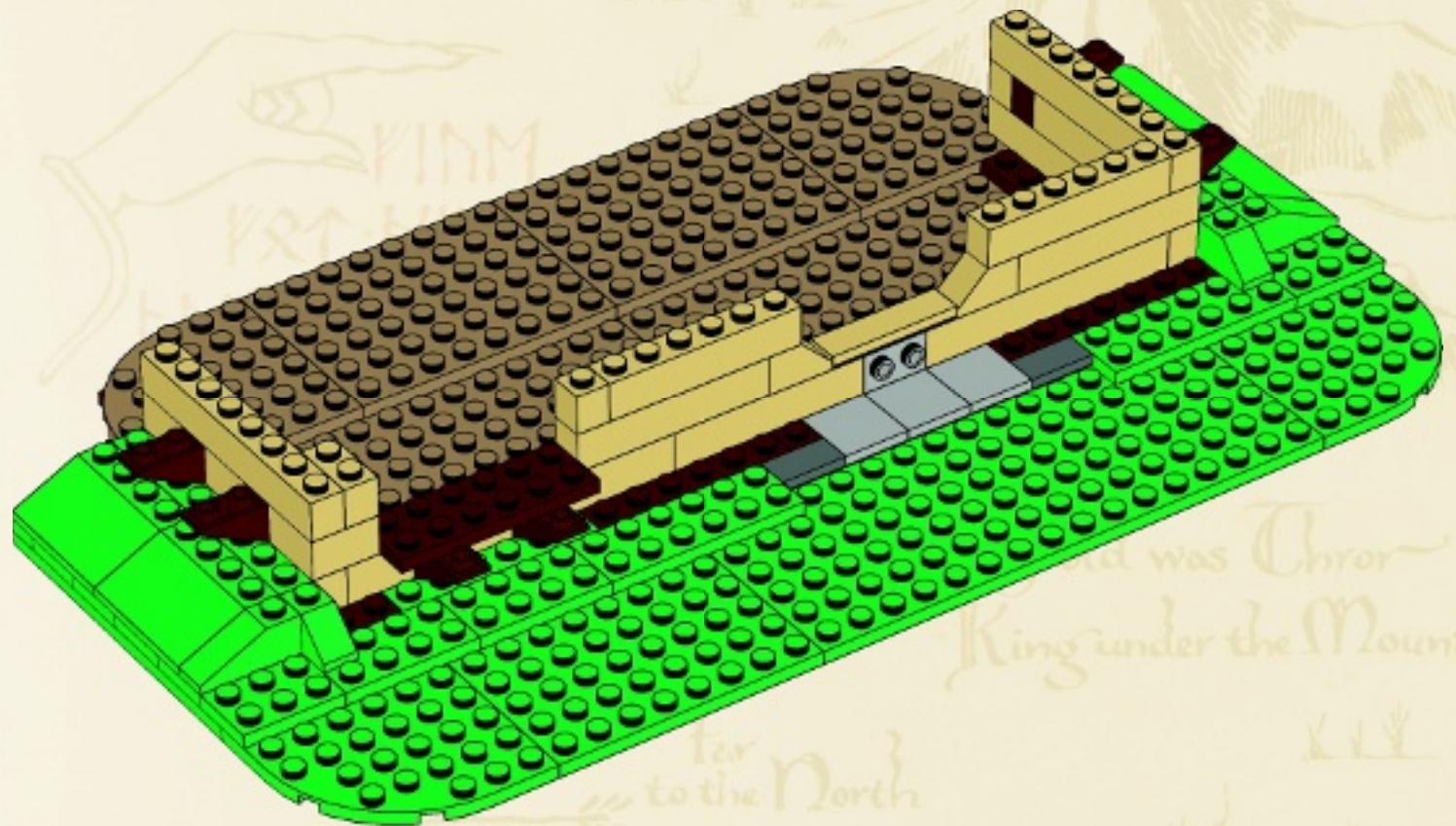

Far  
to the North  
are  
the Grey Mountains  
&  
the Withered Heath  
whence came the

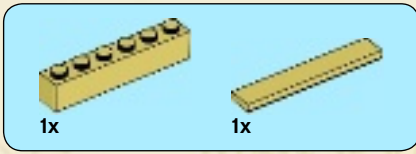

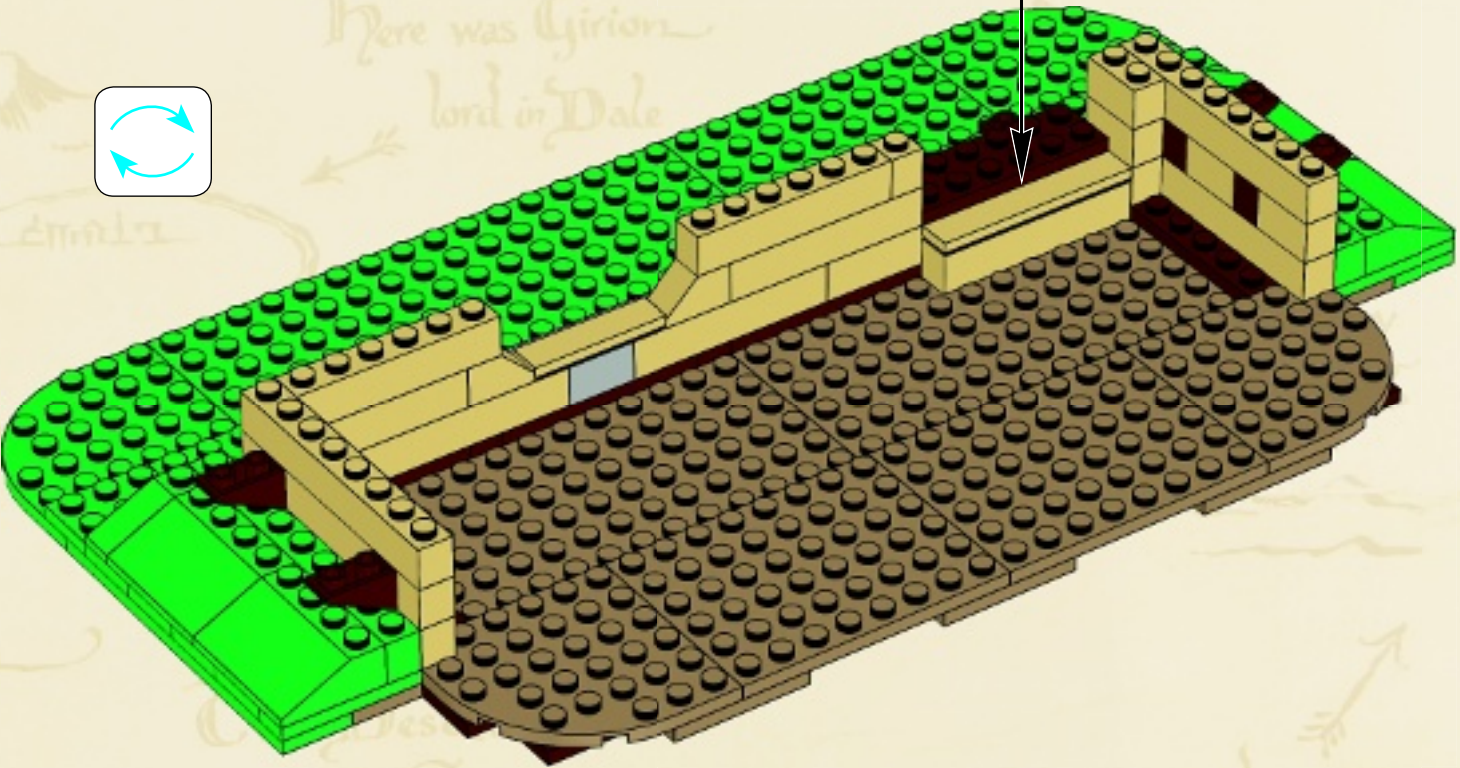
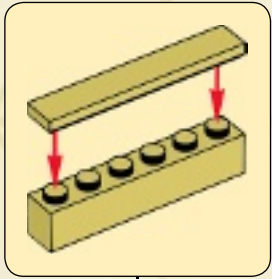

24



*Here was Girion  
lord in Dale*

*of Smaug*

*In Esgaroth upon  
the Long Lake  
dwell Men*

2x  1x 

25

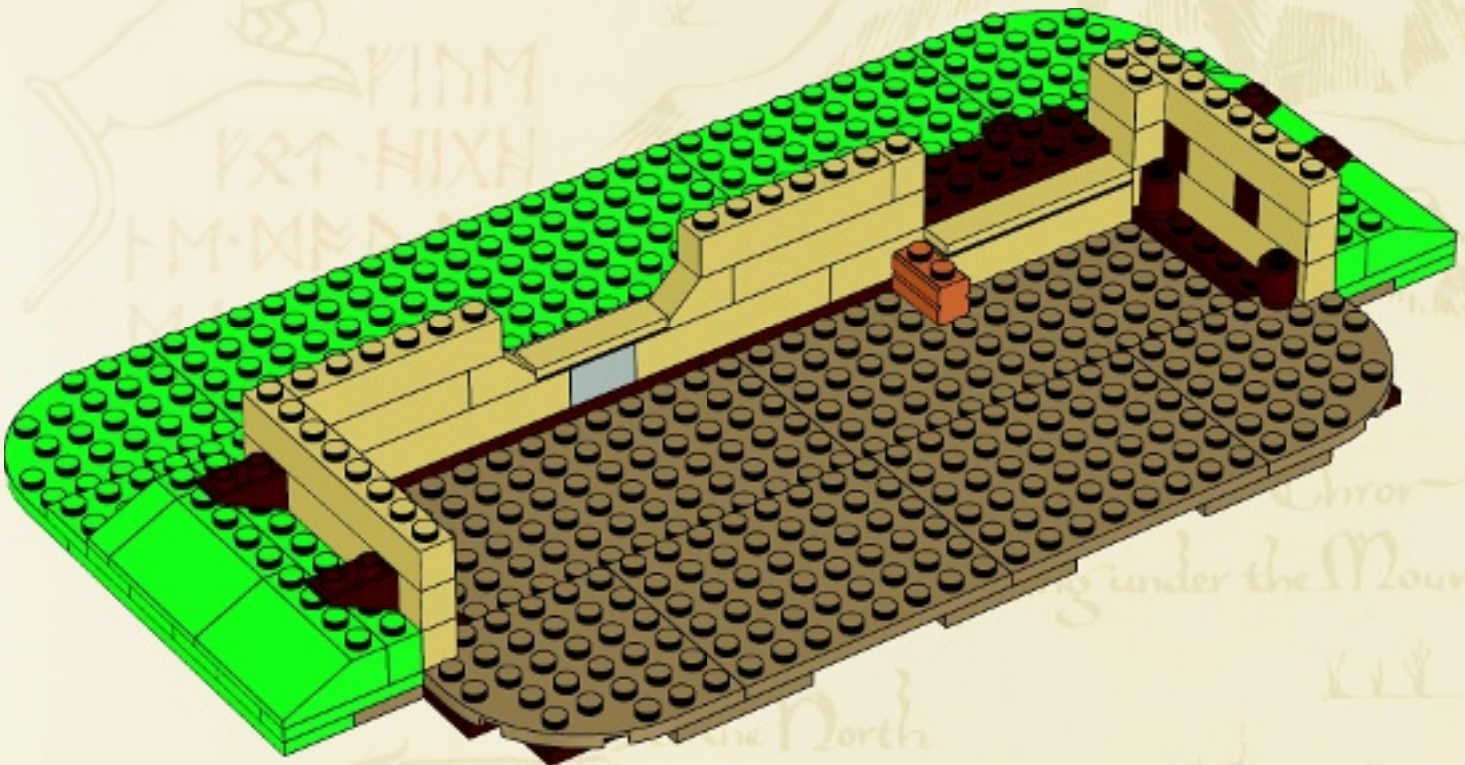



26

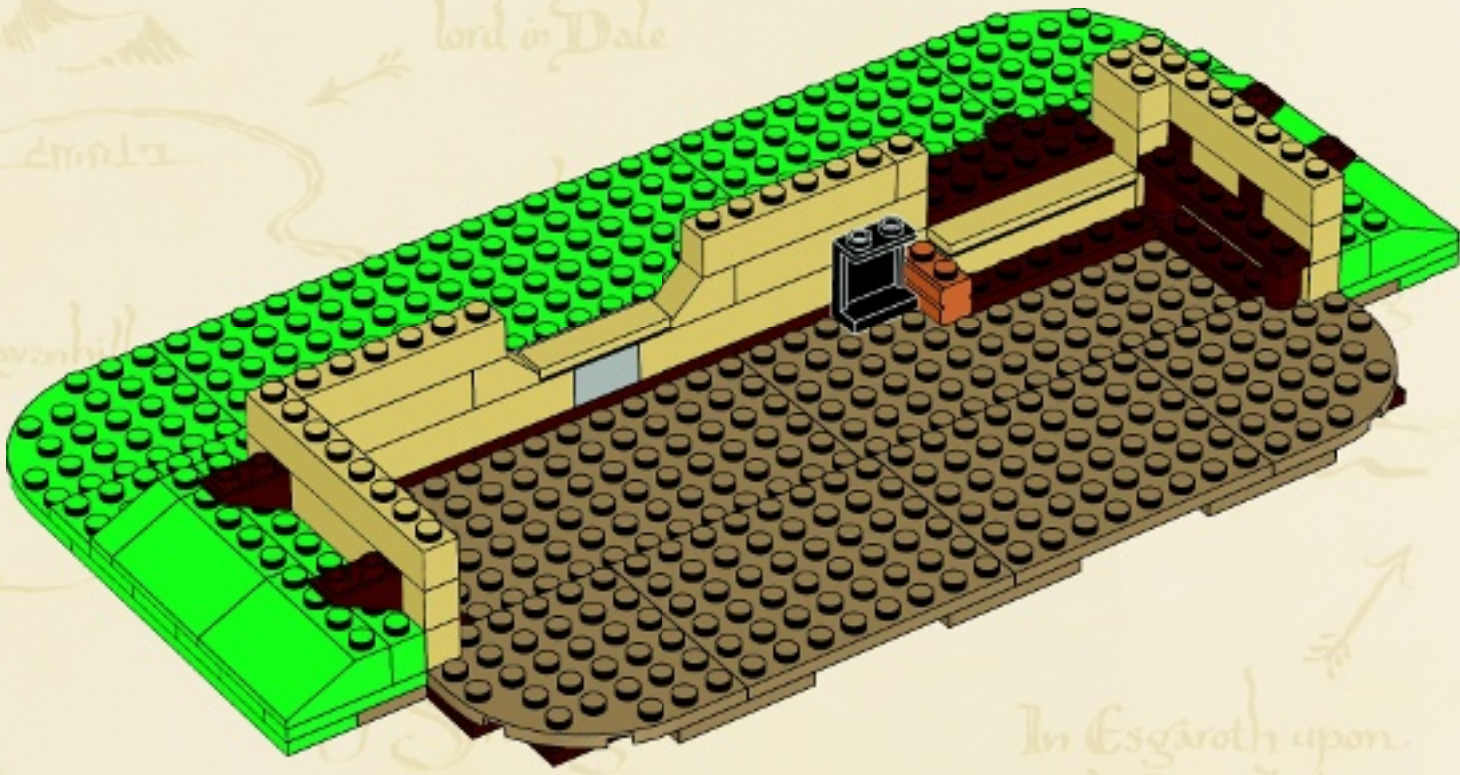

on Hills  
where is Dair

Here was Girton  
lord in Dale

In Esgaroth upon  
the Long Lake  
dwell Men

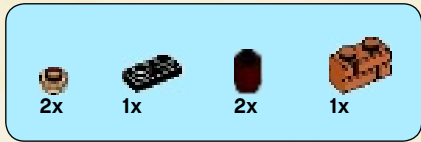

# 27

- 1
- 2

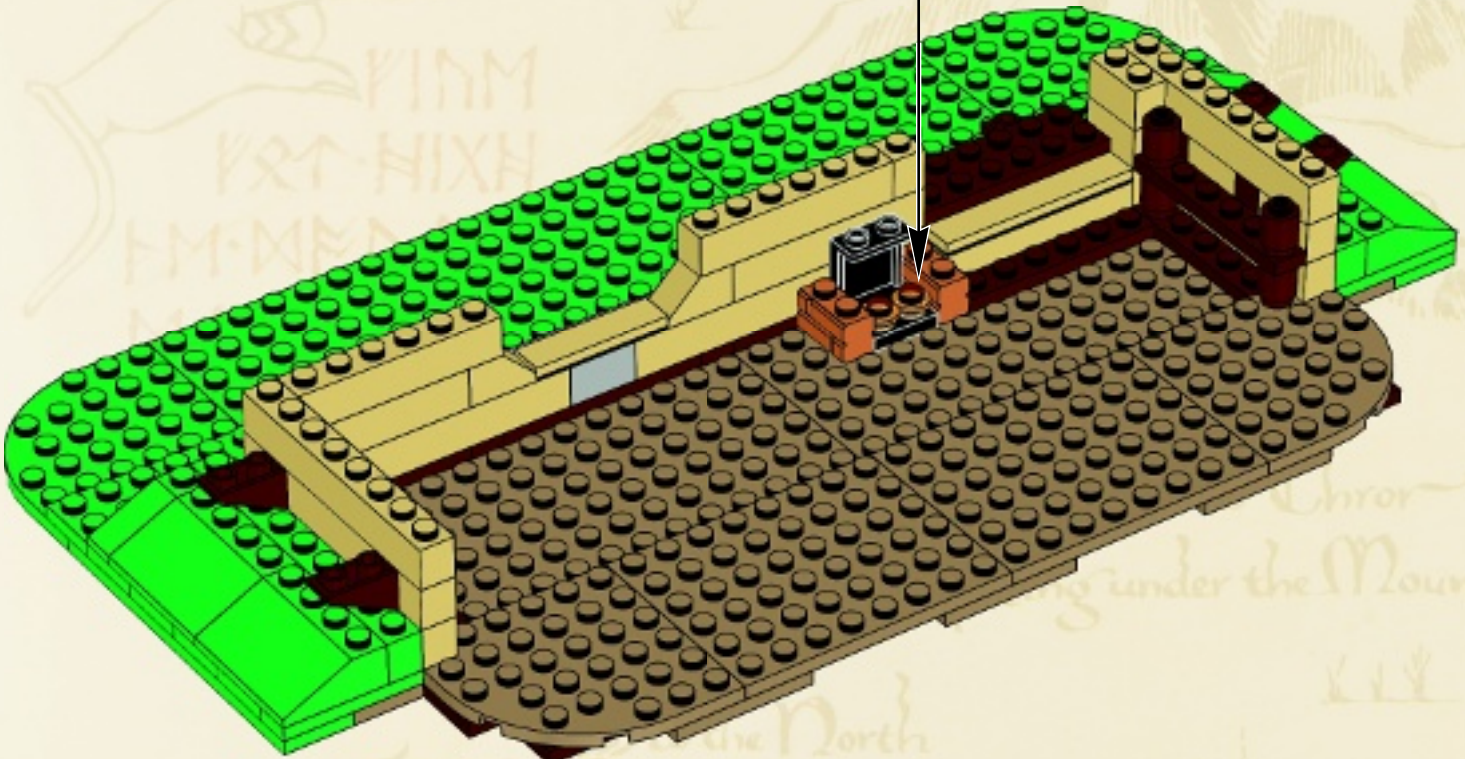



28

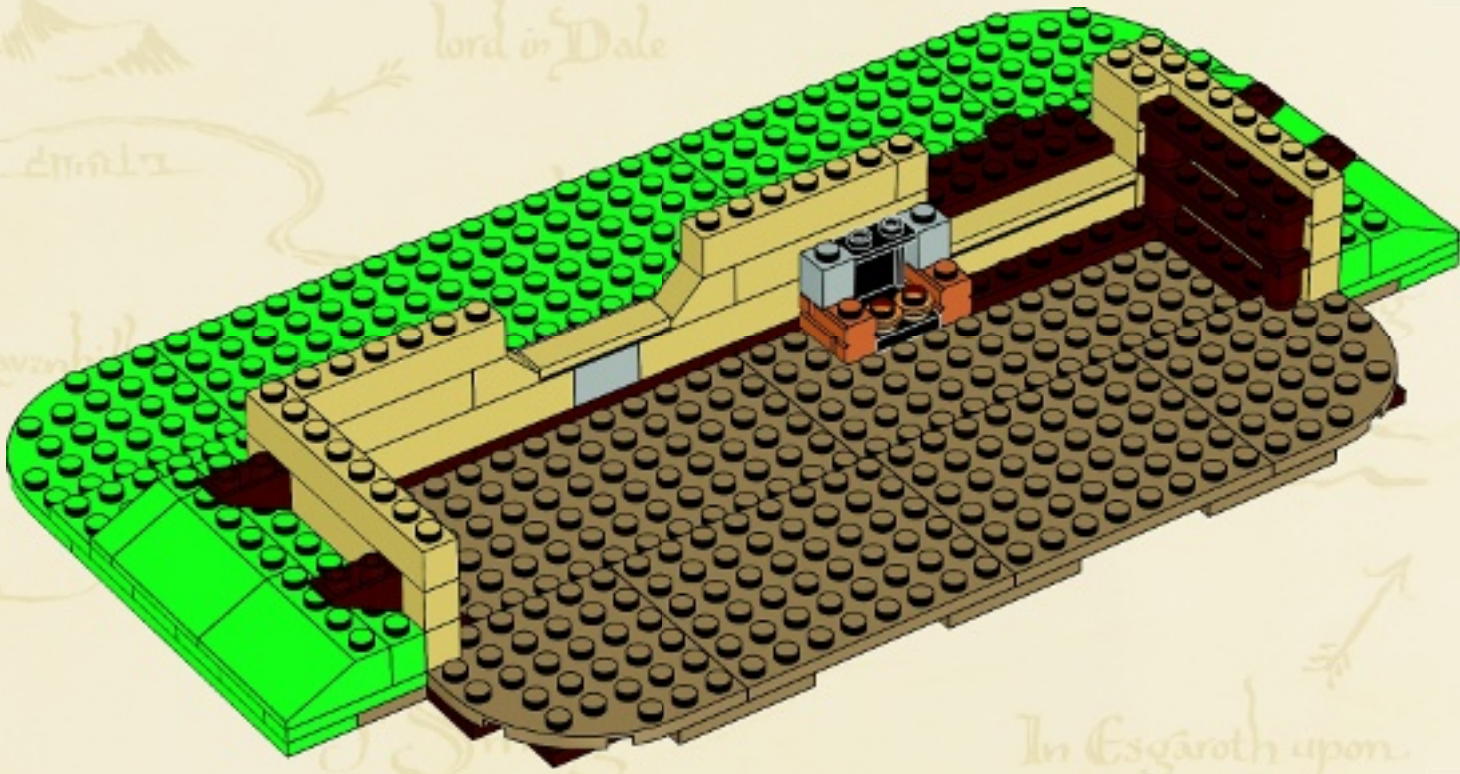

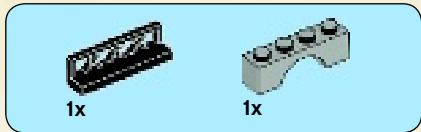

# 29

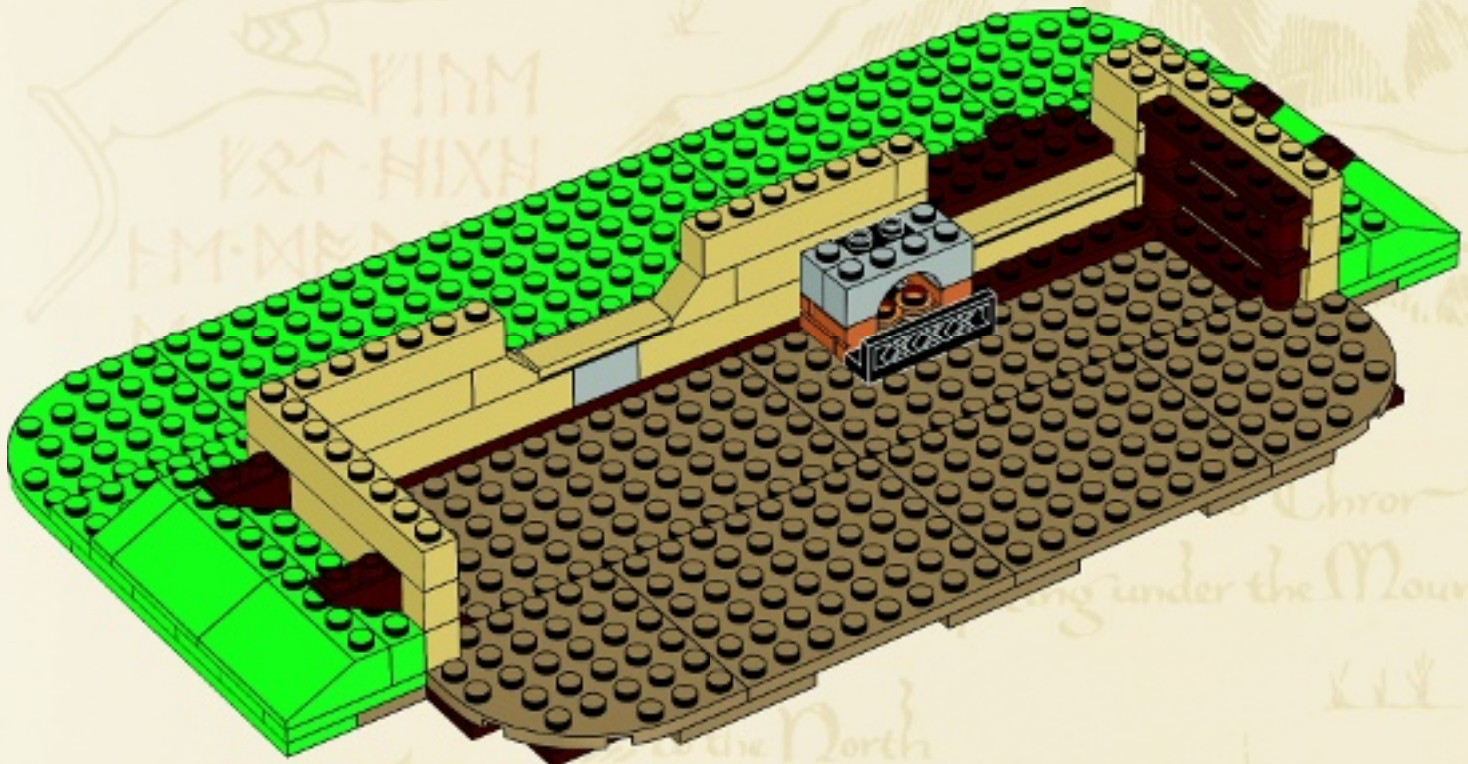

The  
Lonely  
Mountain

Horror  
under the Mountain

the North  
are  
the Grey Mountains  
&  
the Withered Heath  
whence came the



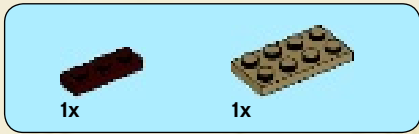

# 30

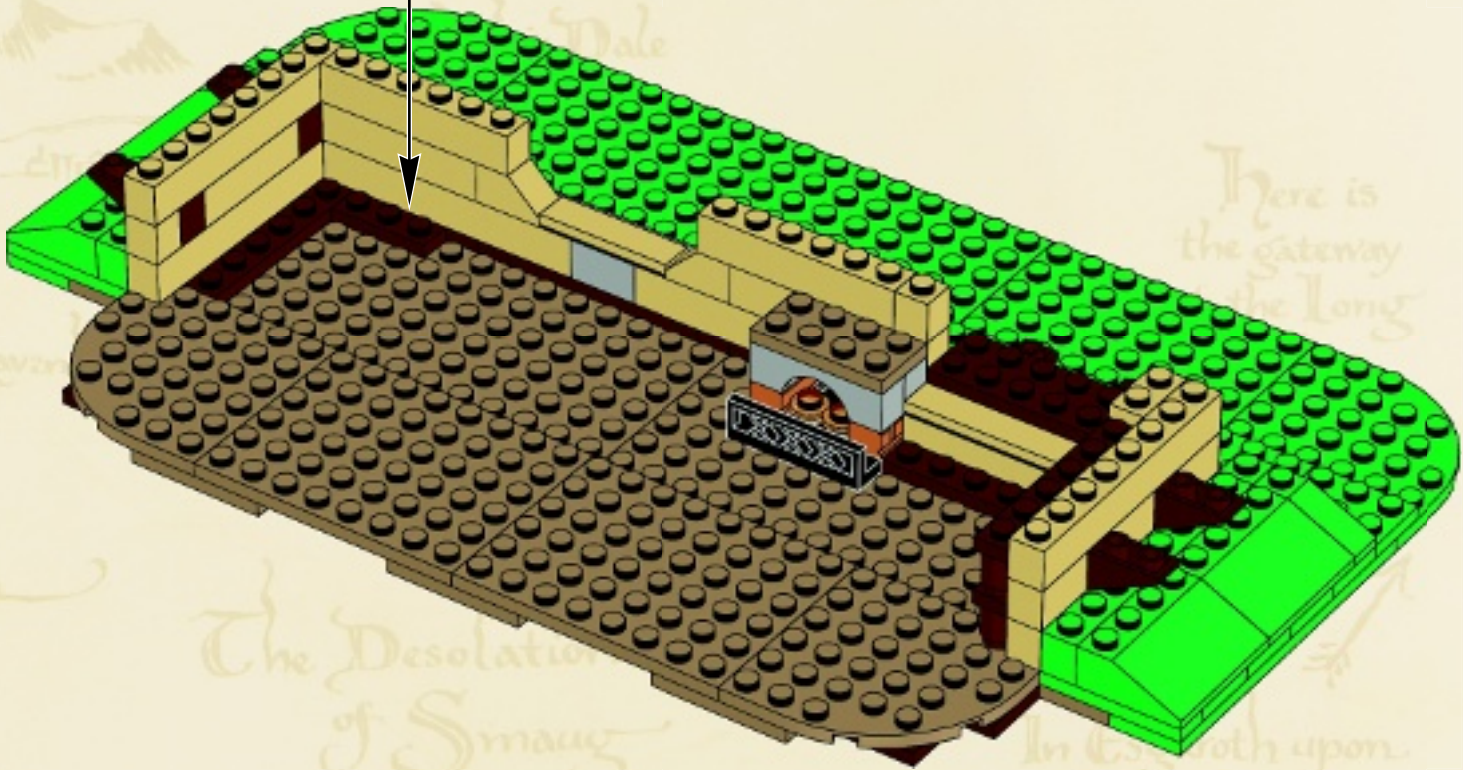
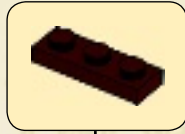
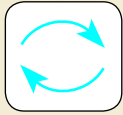



2x



1x

# 31

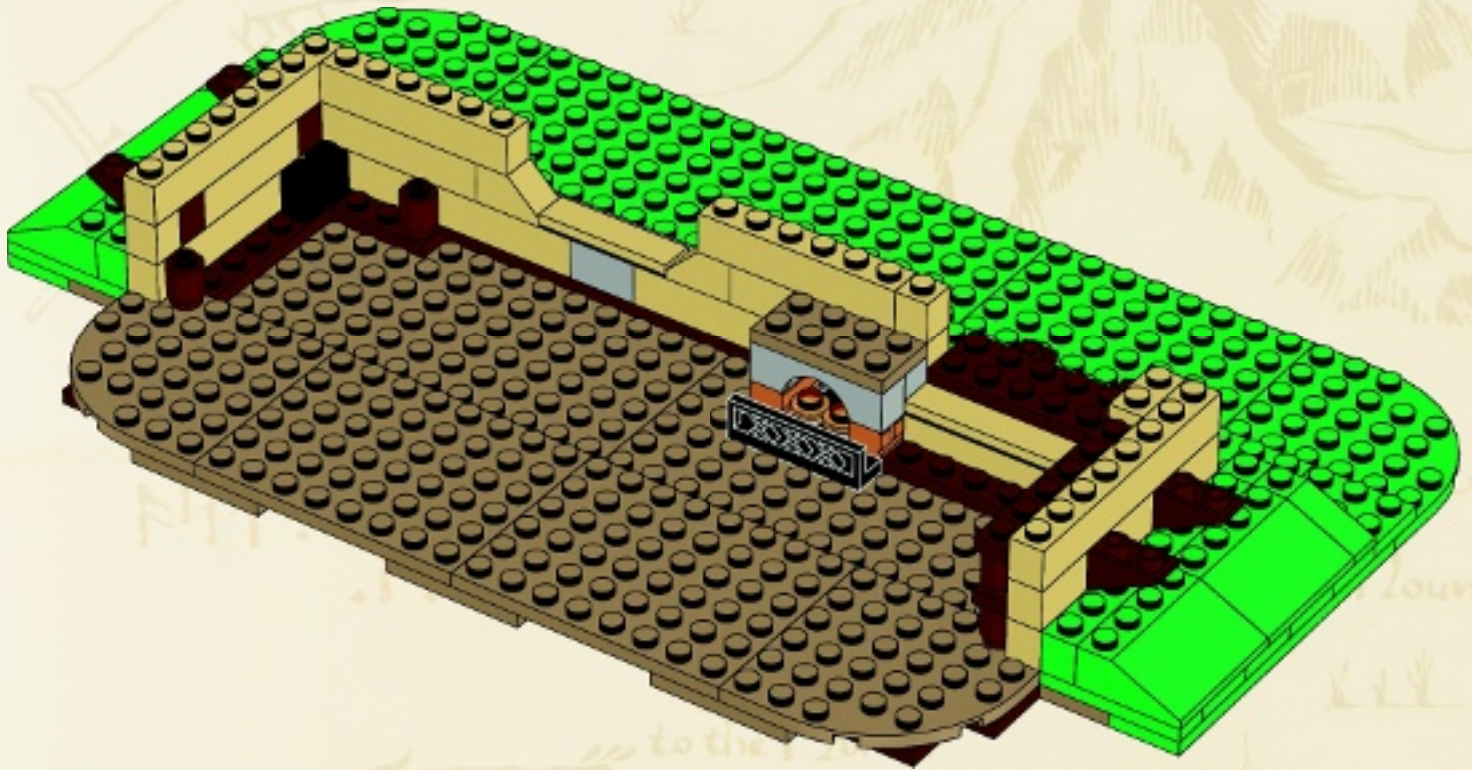

The  
Lonely  
Mountain

to the  
are  
the Grey Mountains  
&  
the Withered Heath  
whence came the

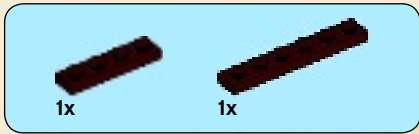

32

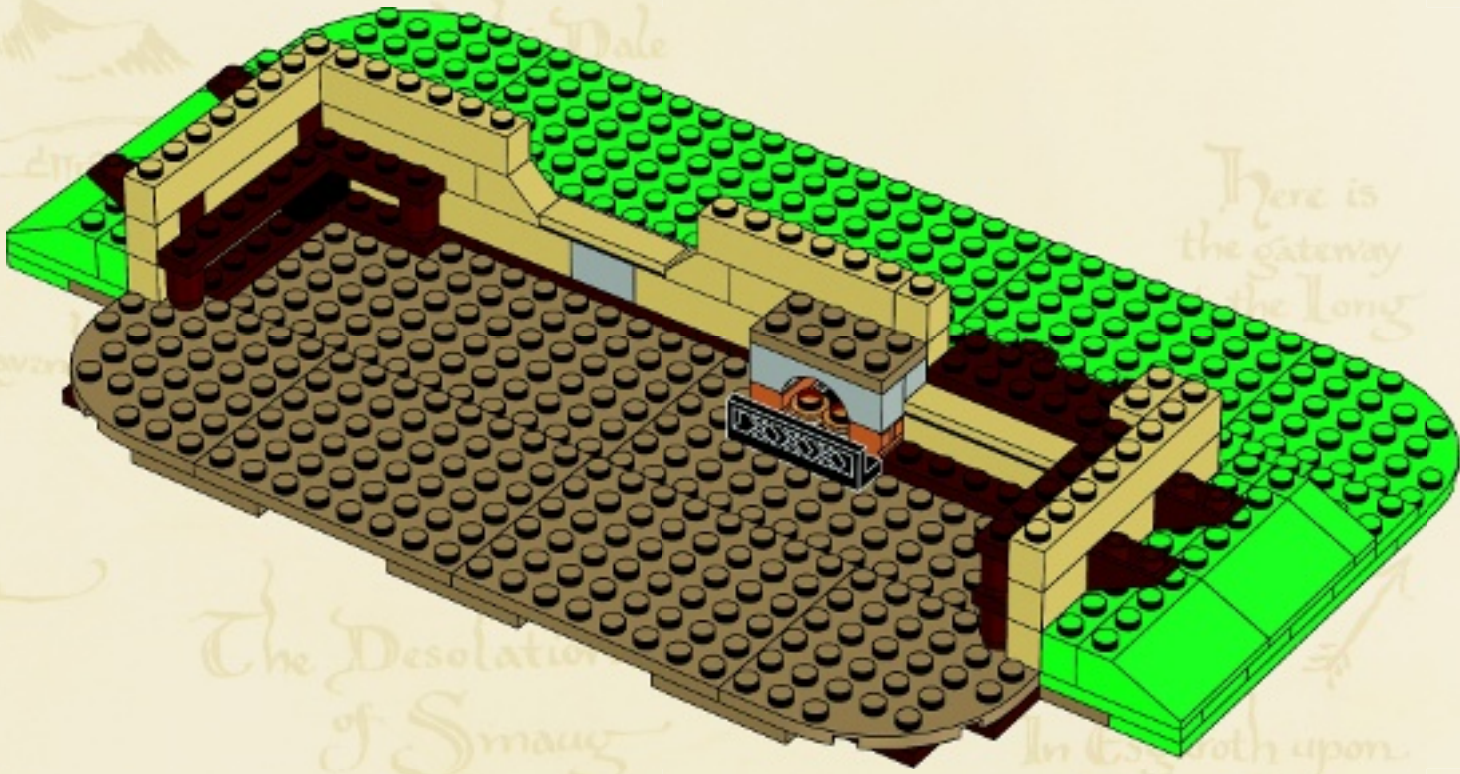

*Iron Hills*  
*where is Dain?*  
*Here was Girion's Dale*  
*Here is the gateway to the Long Lake*  
*The Desolation of Smaug*  
*In Gorthorn upon the Long Lake dwell Men*



2x



1x

# 33

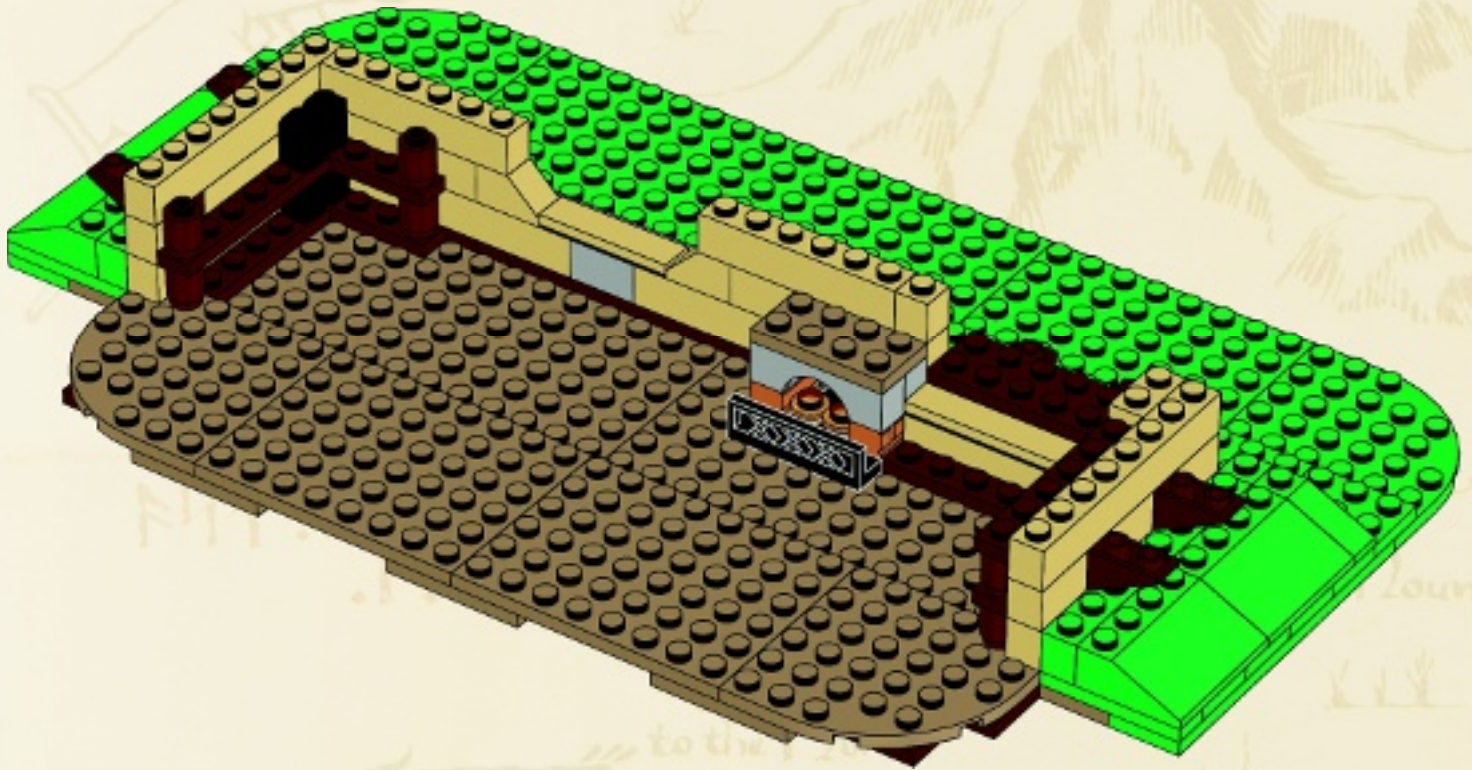

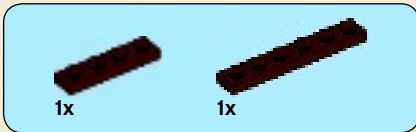

34

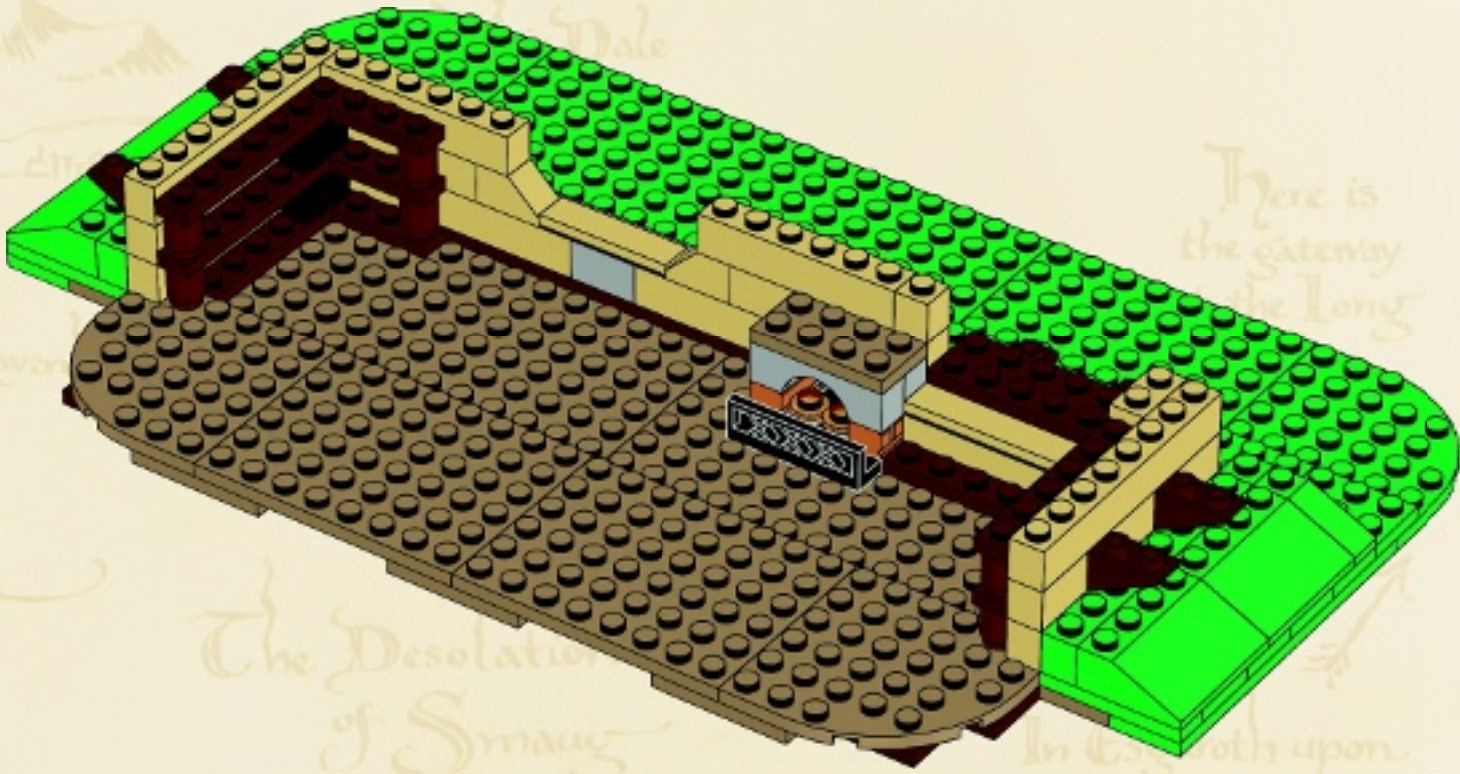

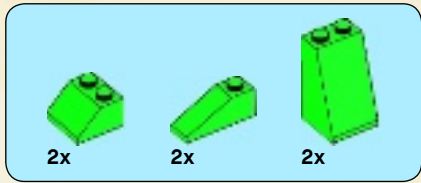

35

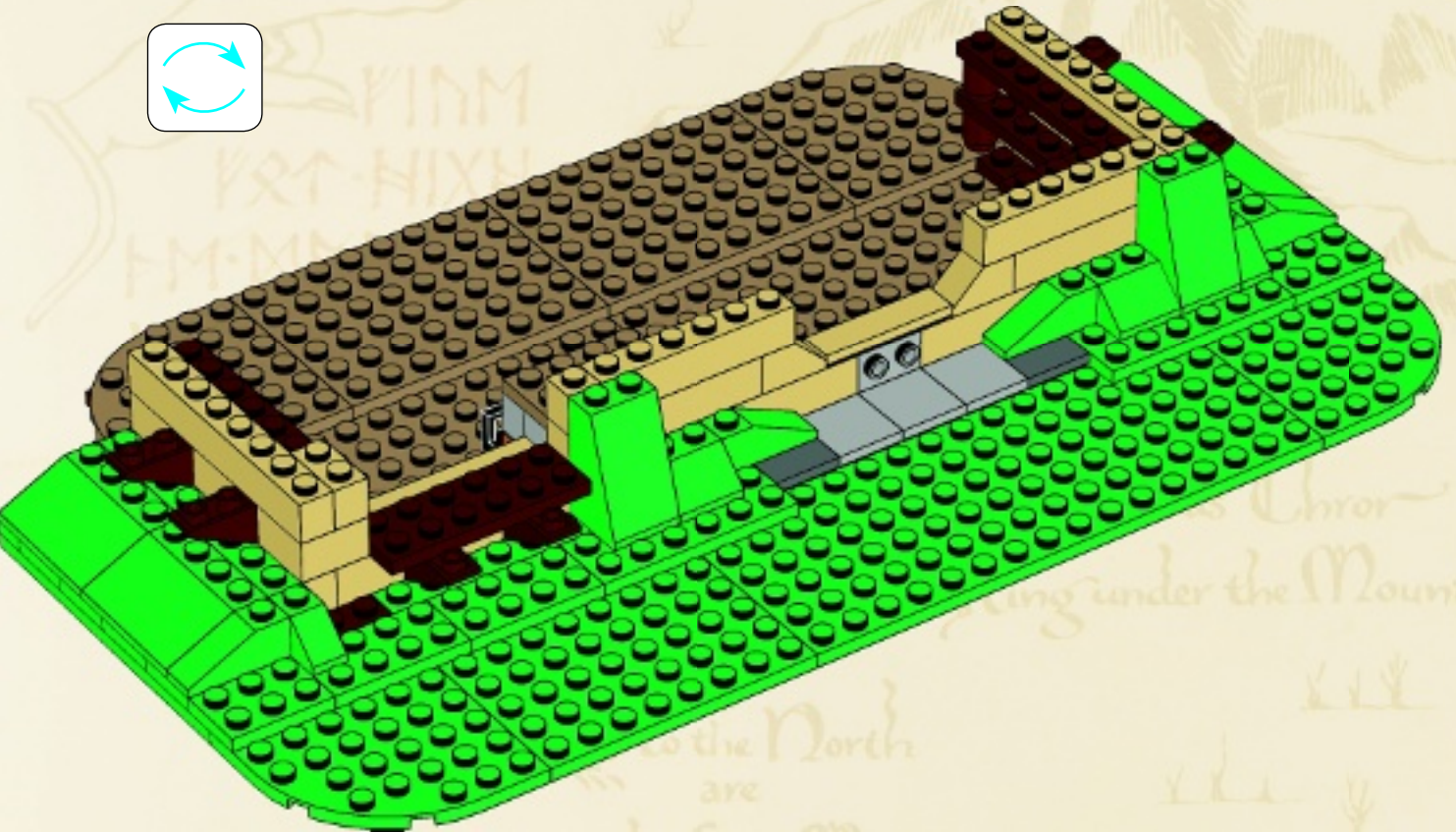

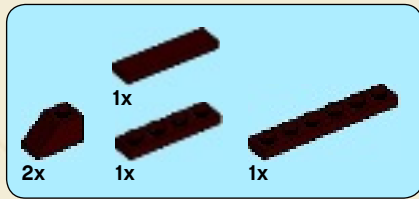

36

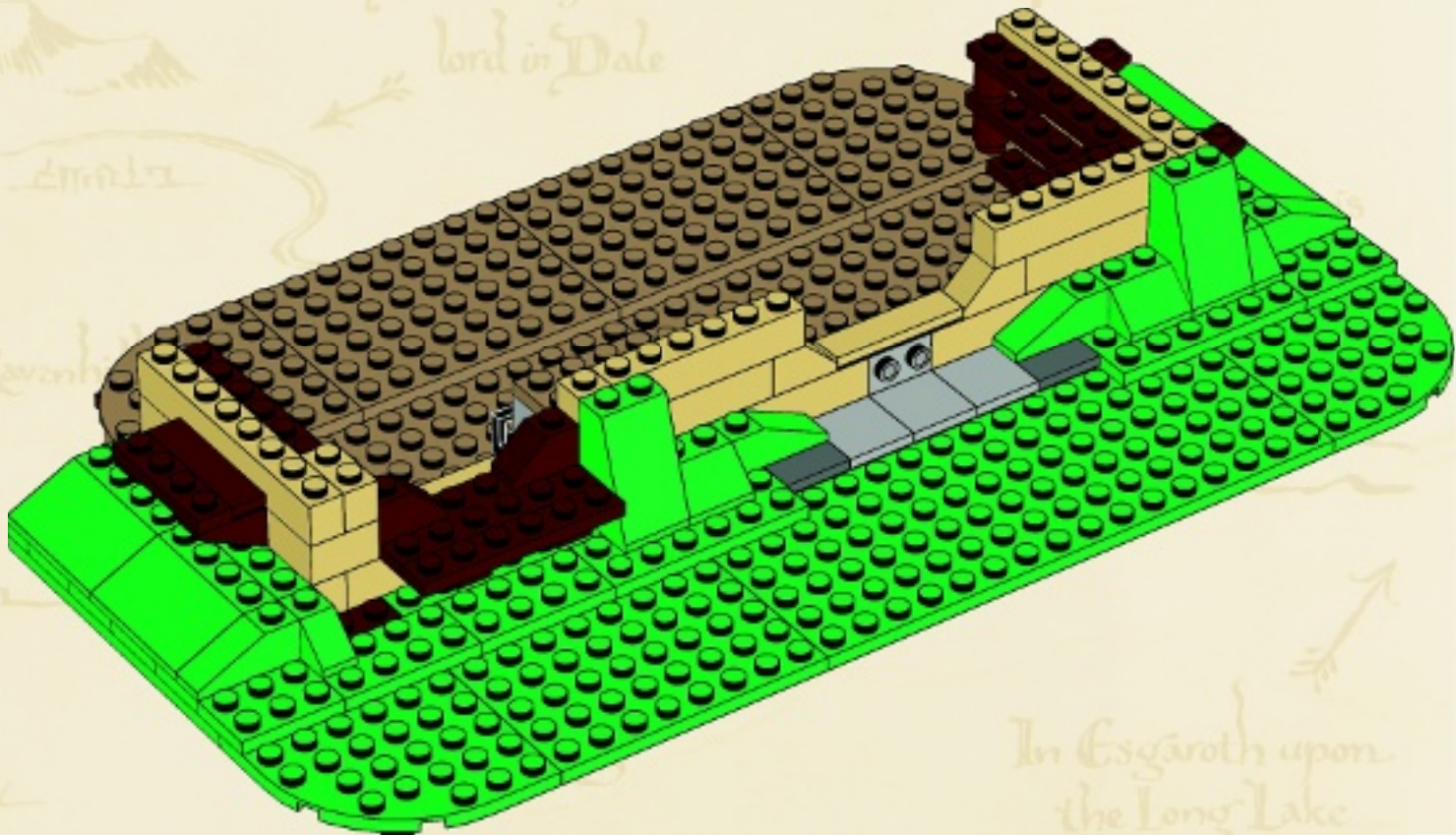



2x



2x

37

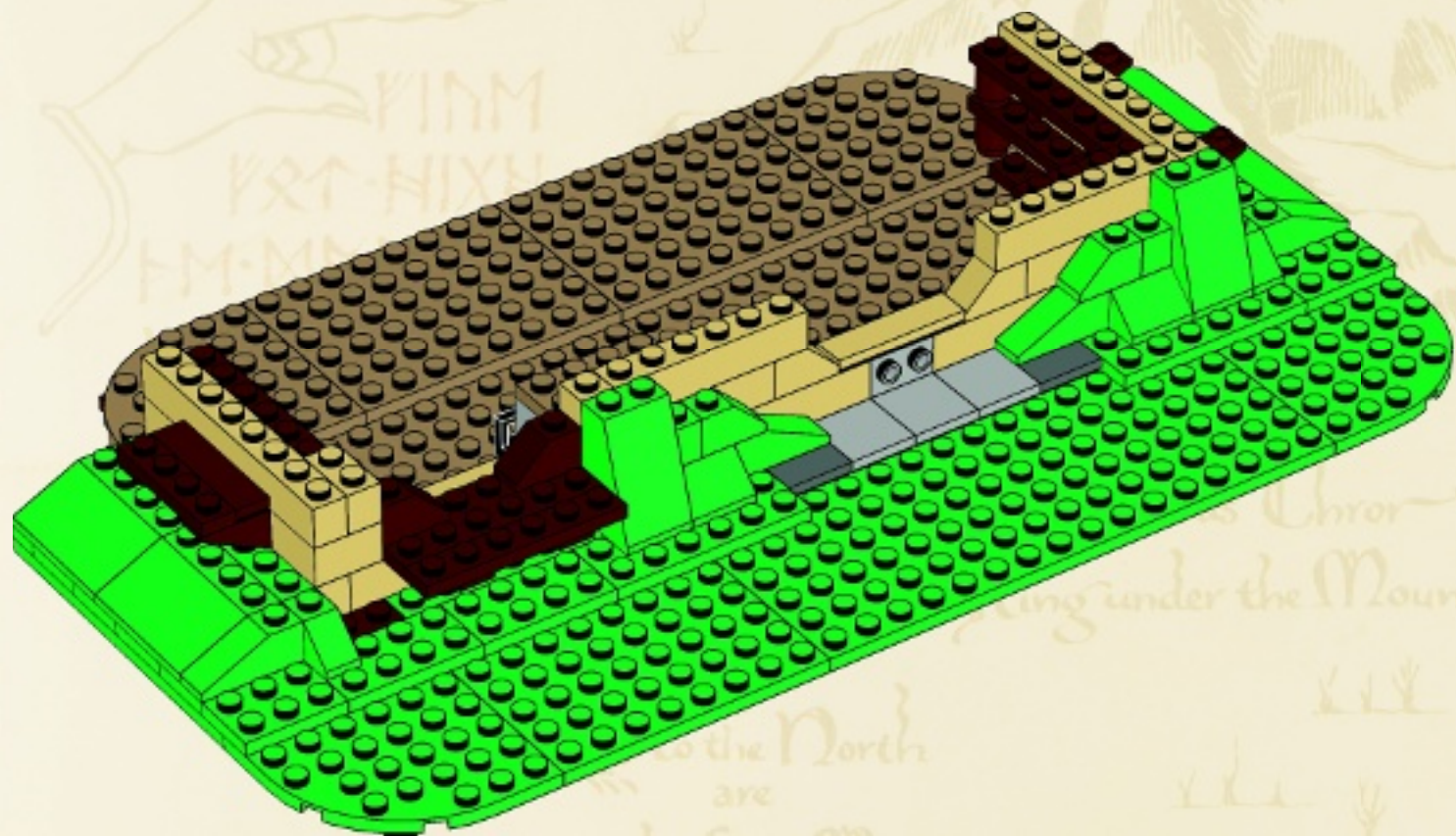

The  
Lonely  
Mountain

to the North  
are  
the Grey Mountains  
&  
the Withered Heath  
whence came the

Chror  
ing under the Mount



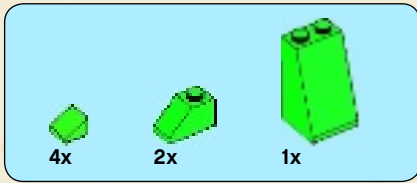

38

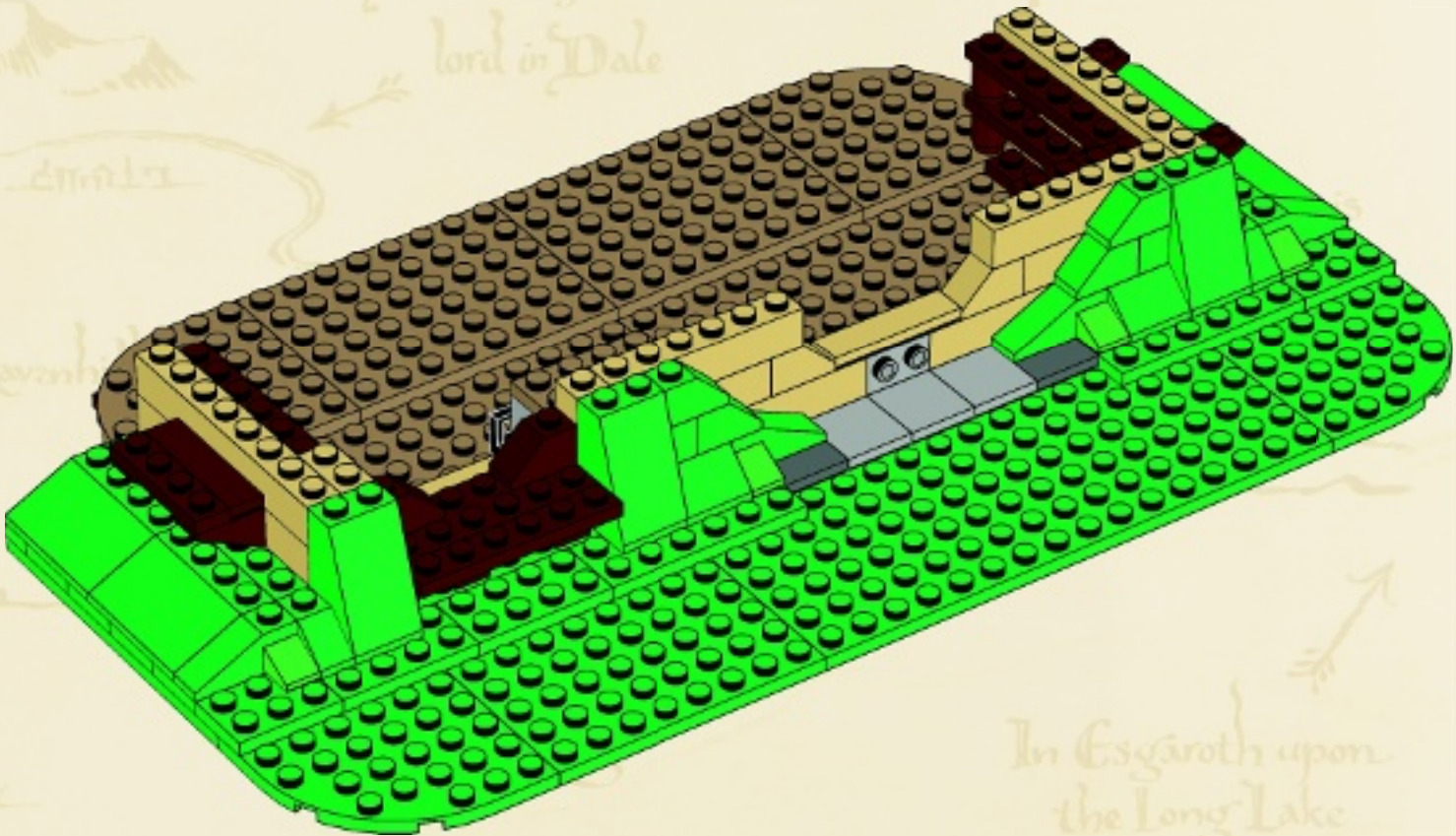

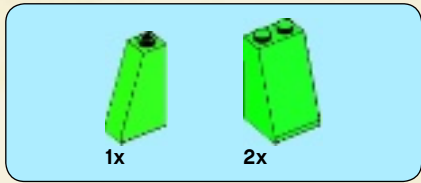

39

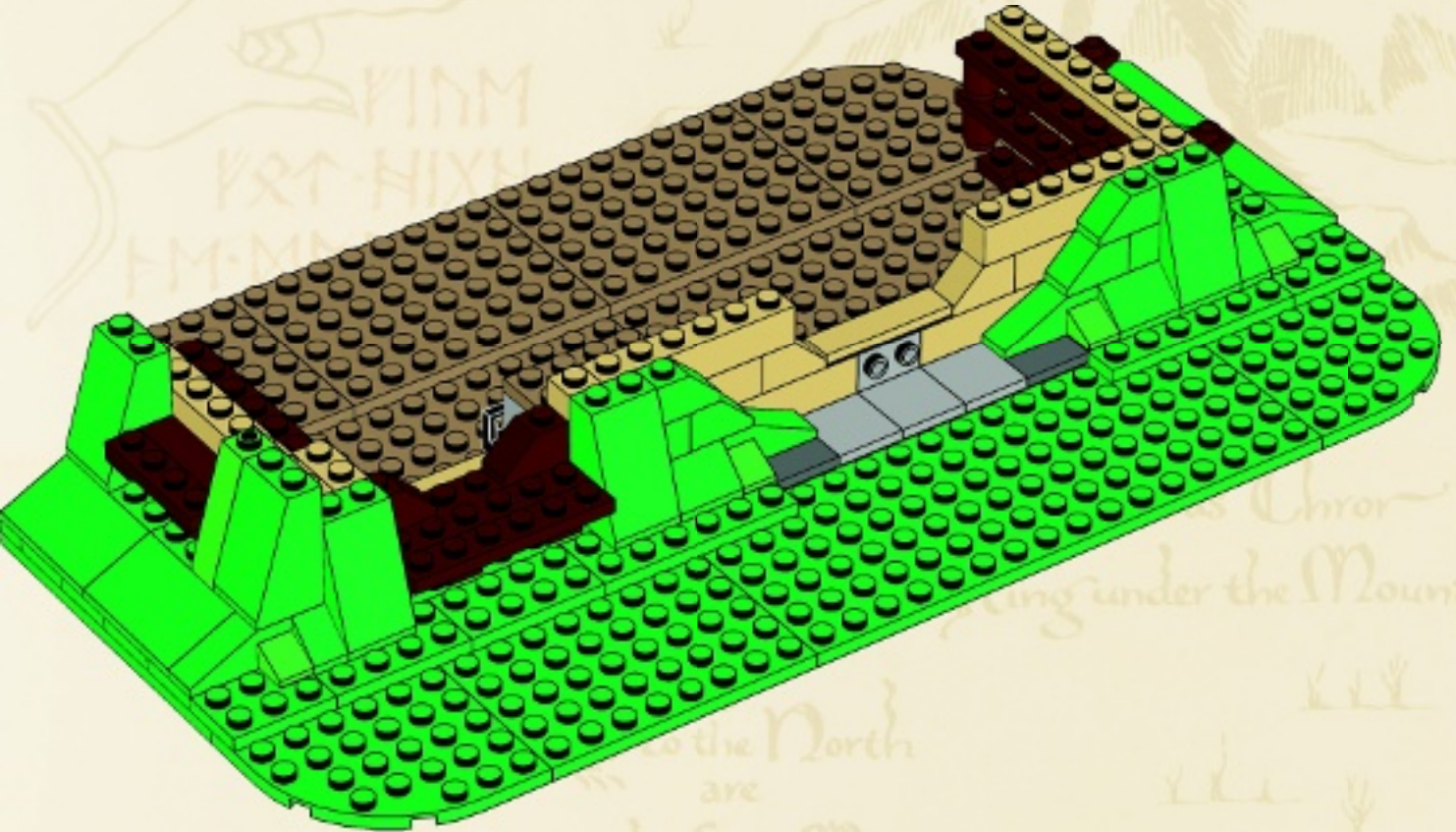

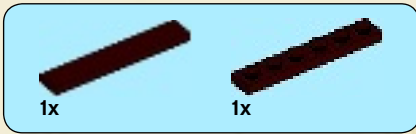

40

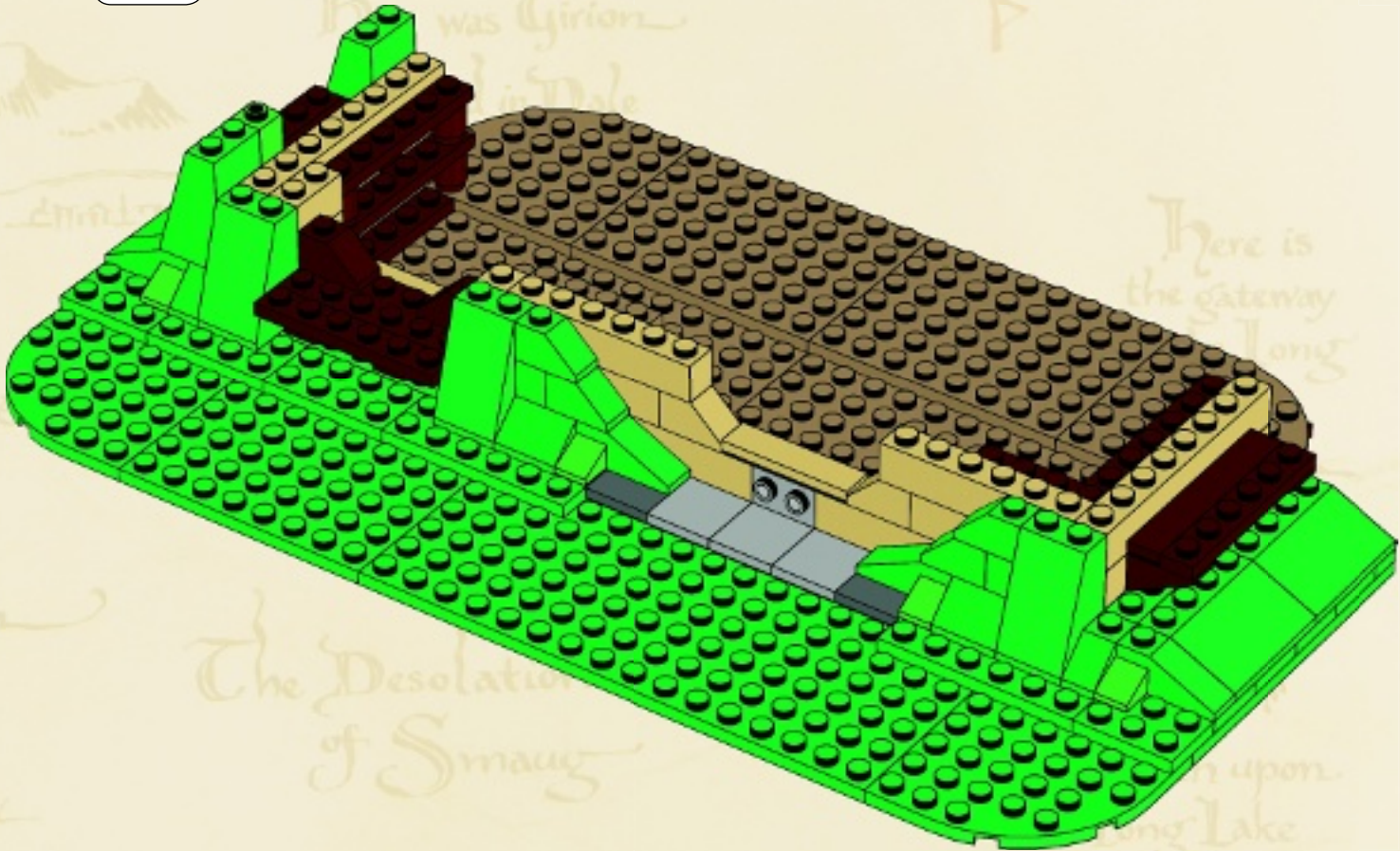

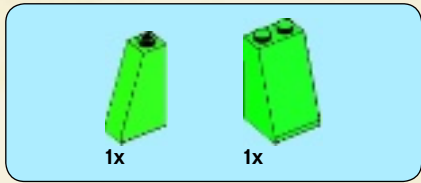

41

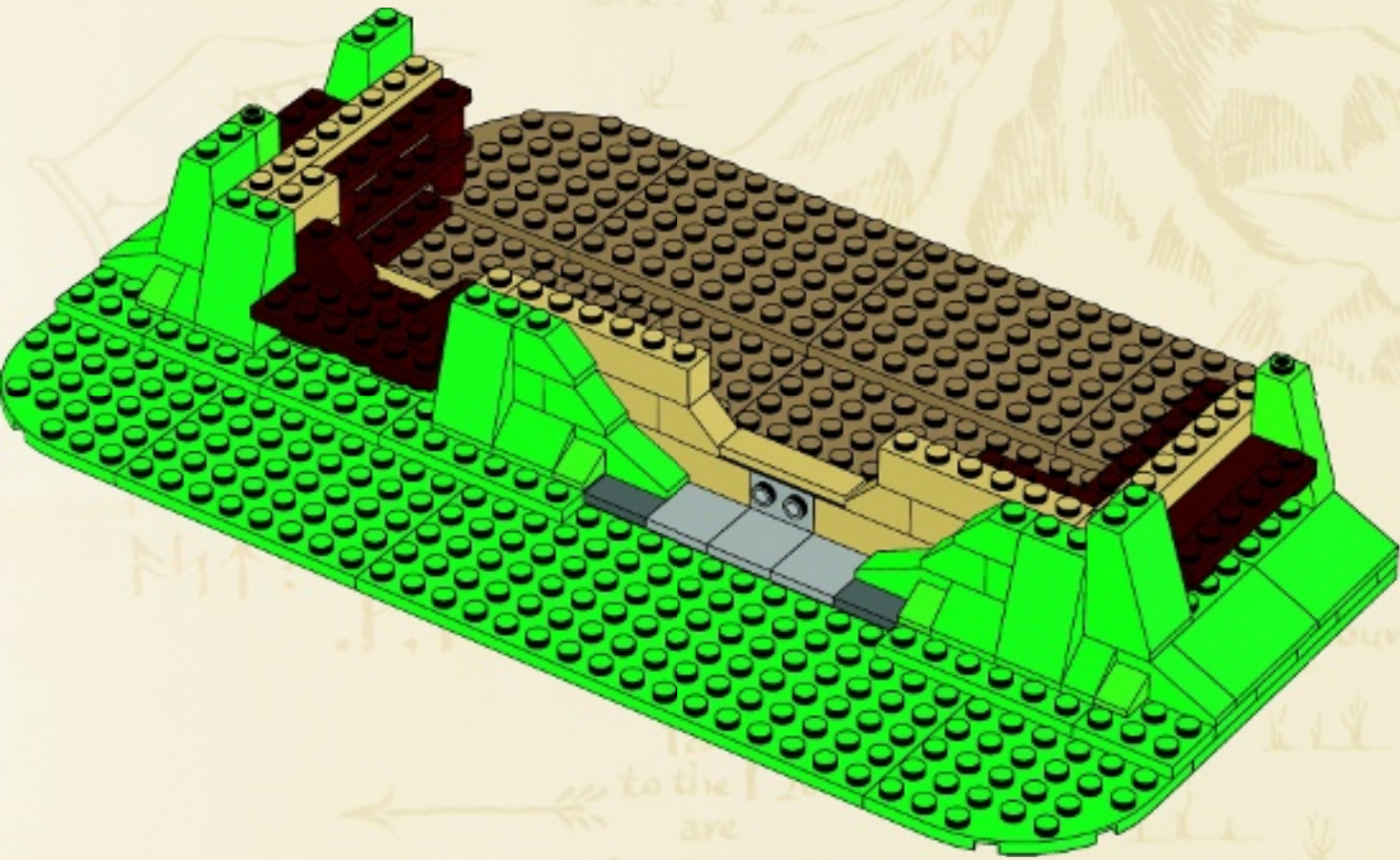

The  
Lonely  
Mountain

to the  
are  
the Grey Mountains  
&  
the Withered Heath  
whence came the

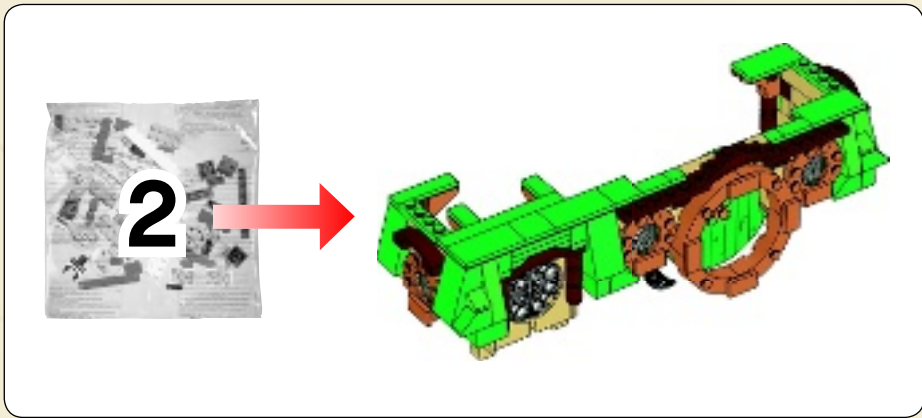

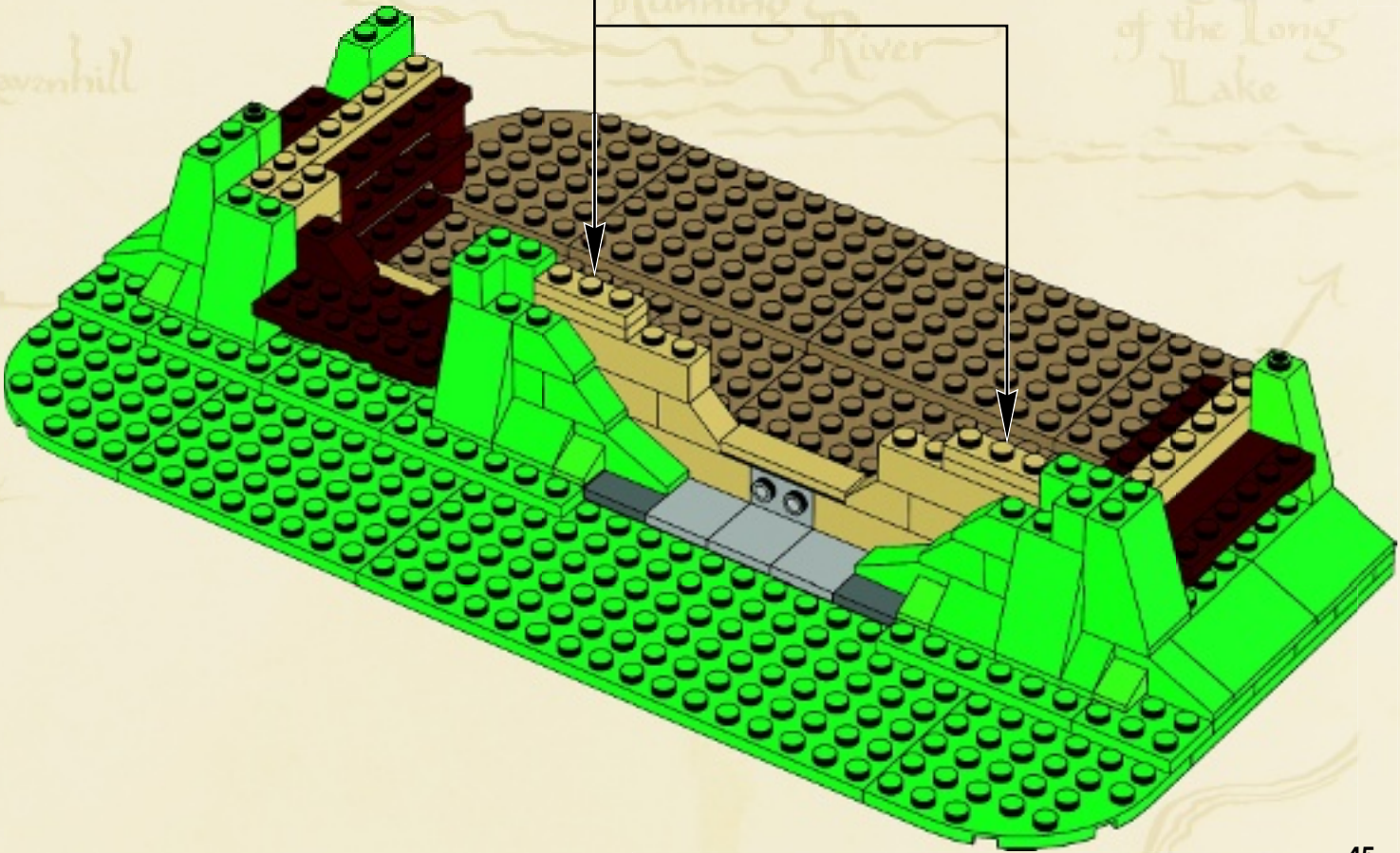
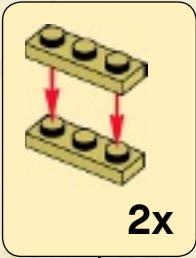

42



 1x	 1x	 2x
--	--	--

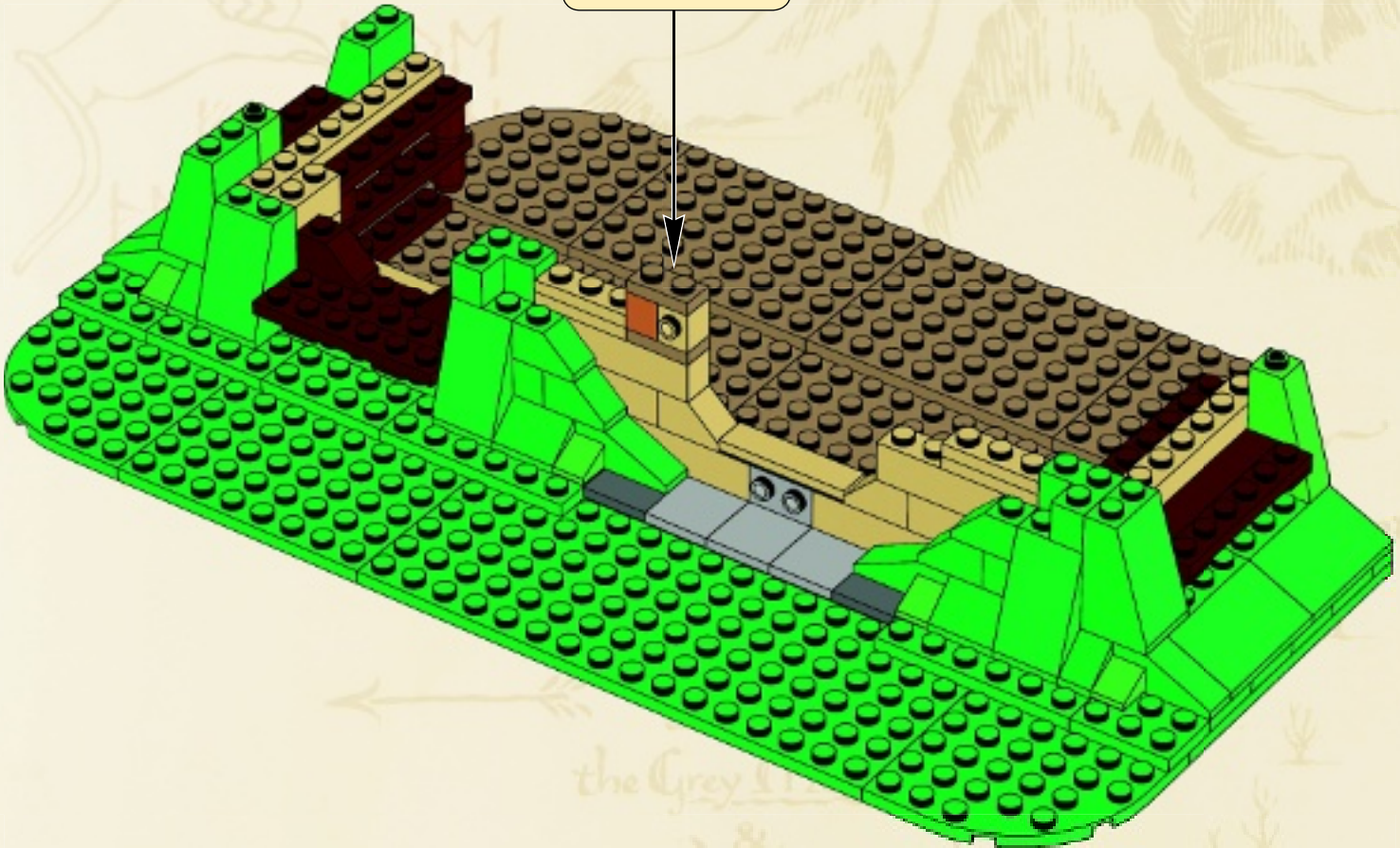

# 43

- 
- 
- 



1x 1x 2x

# 44

- 1 
- 2 
- 3 

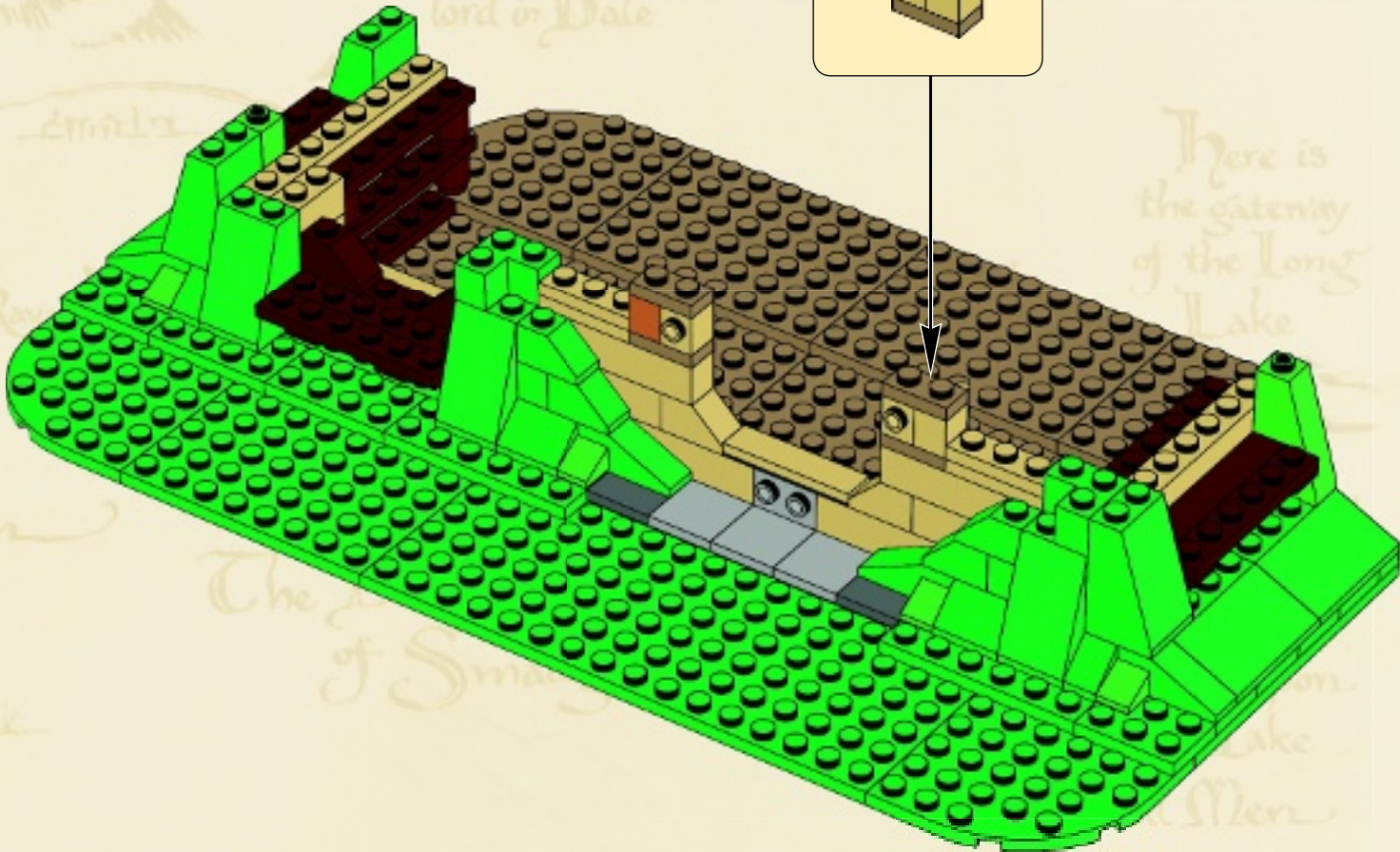

		
2x	2x	1x

# 45

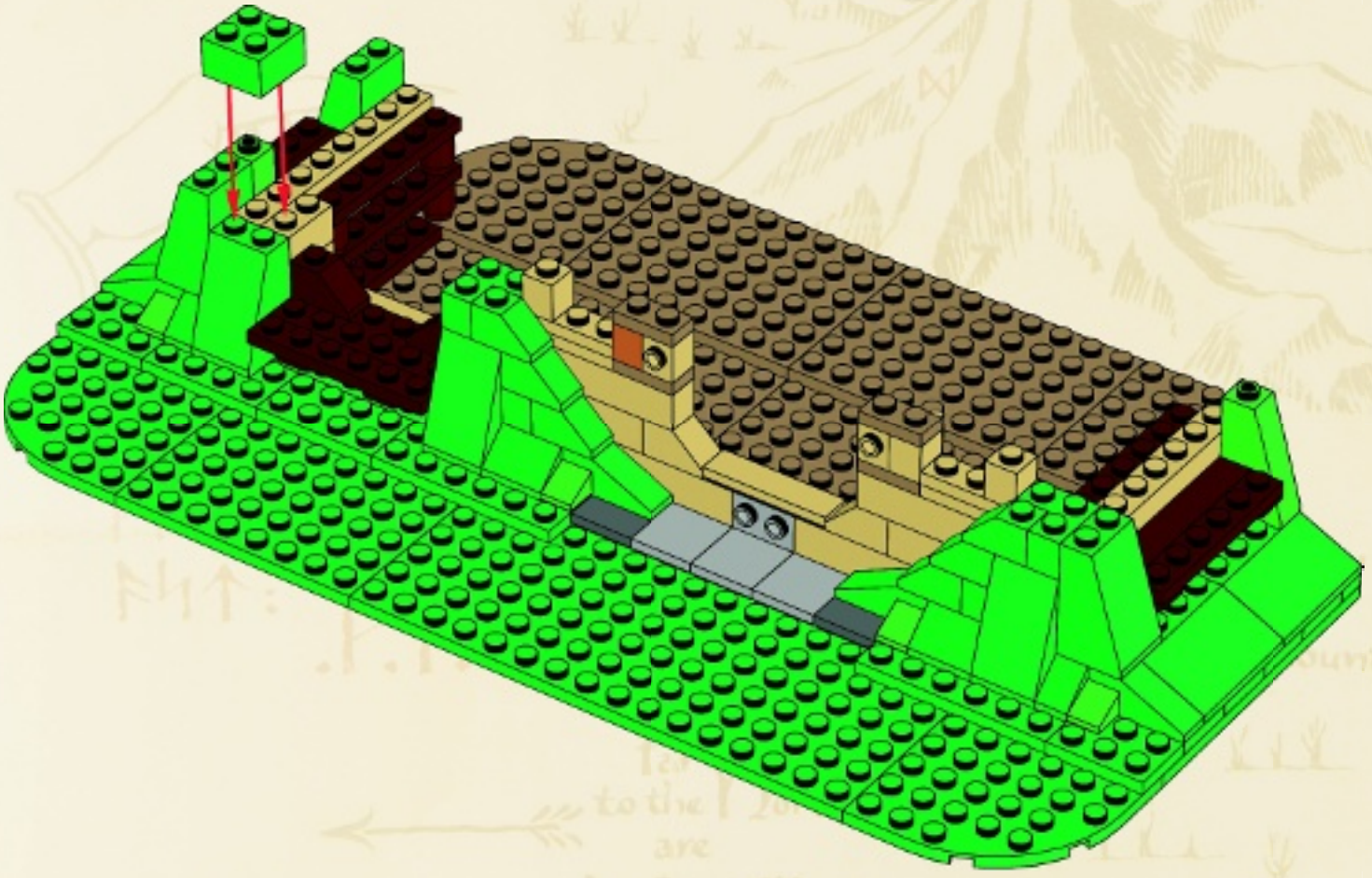





2x



2x

# 46

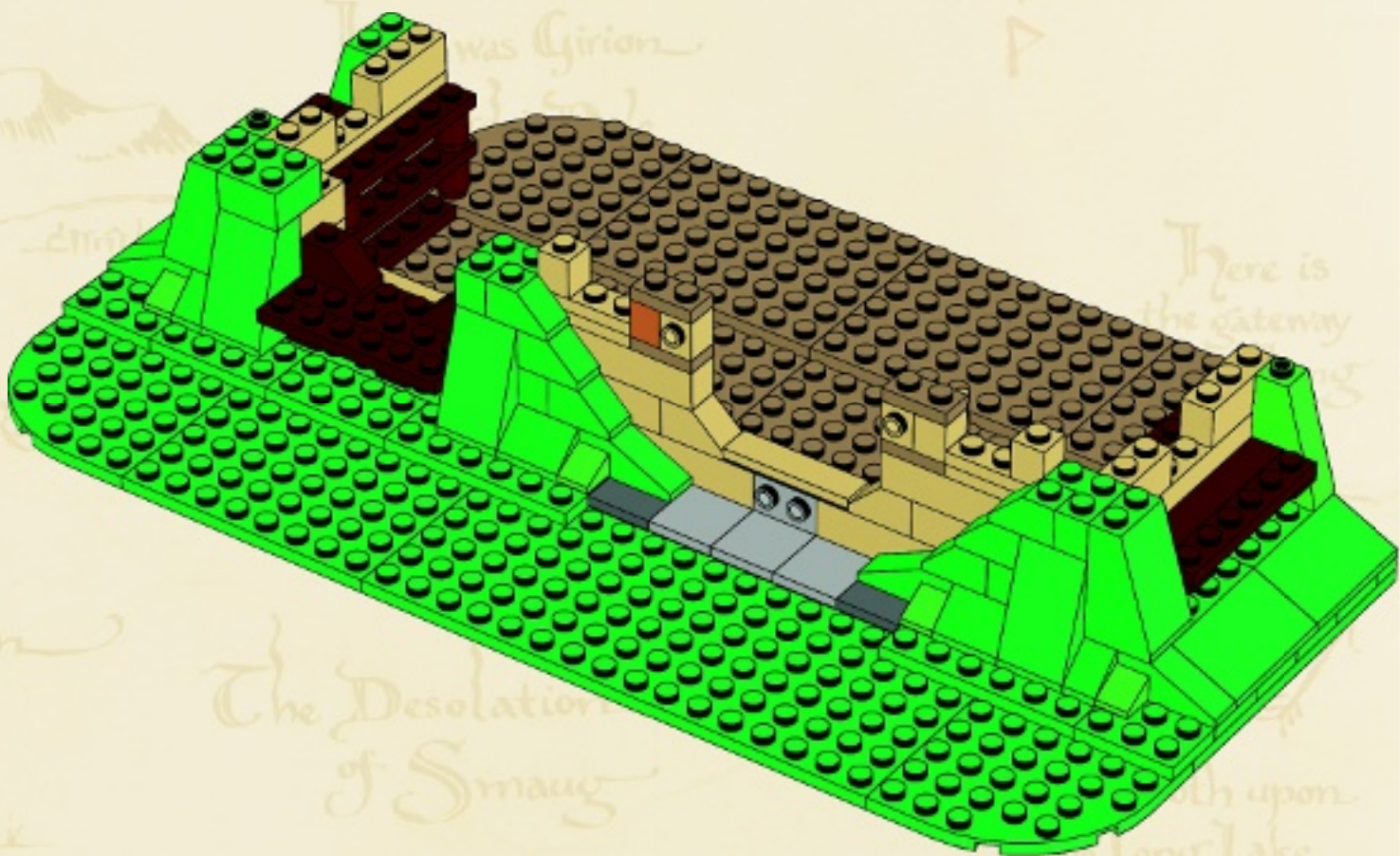

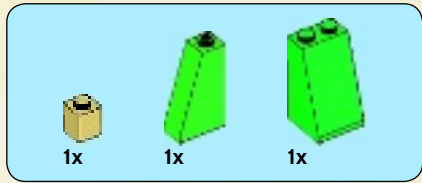

47

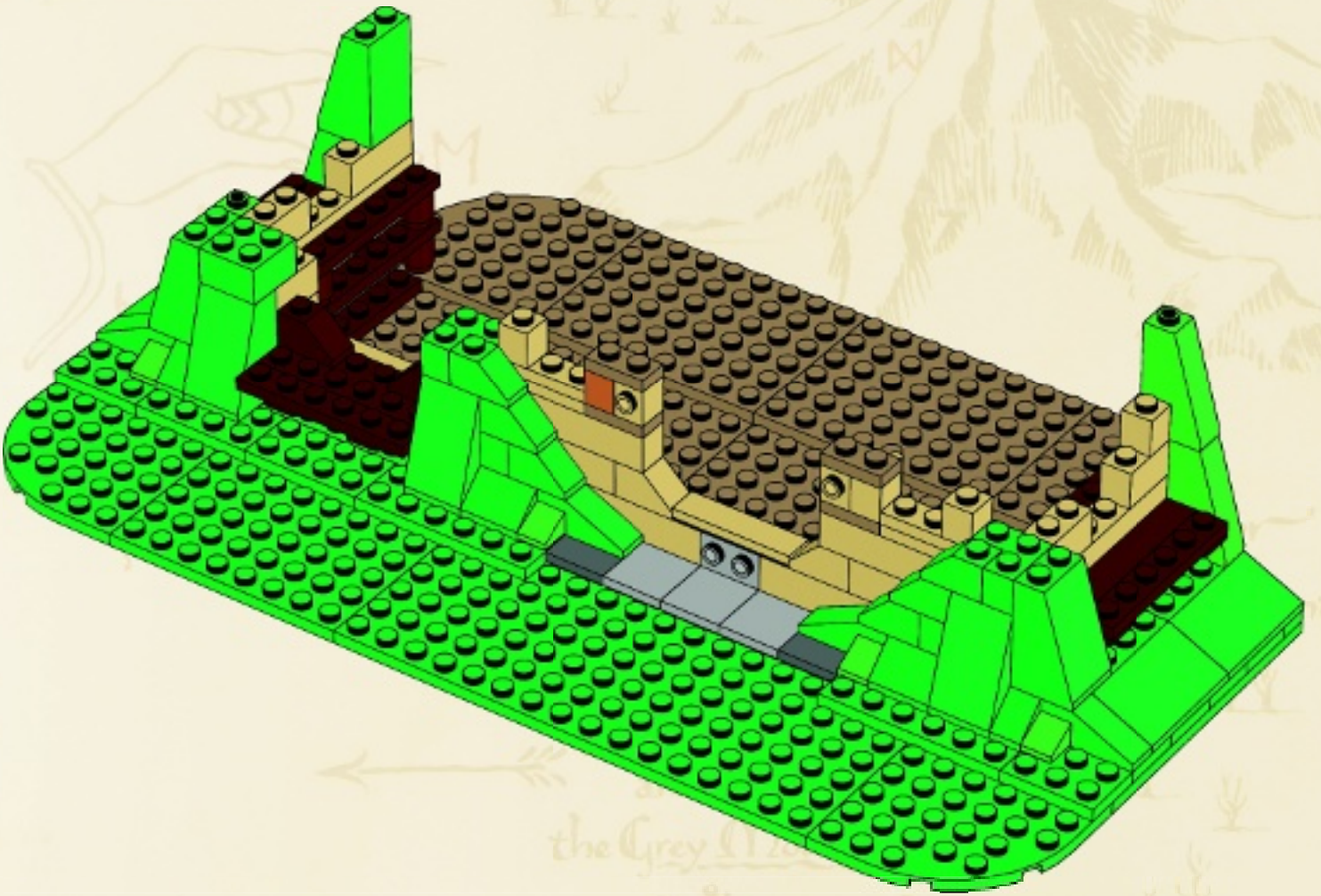



48

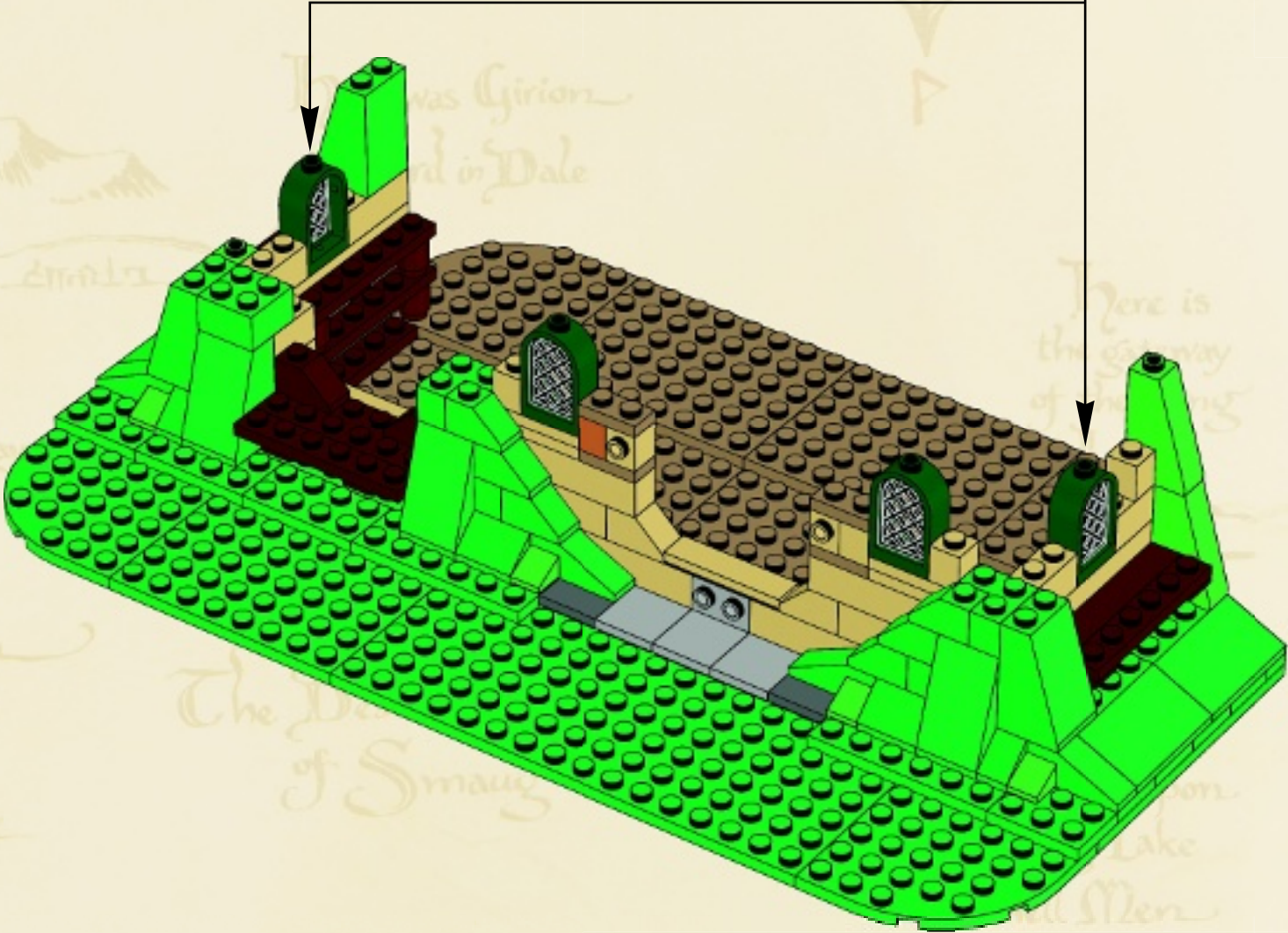

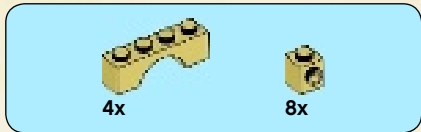

49

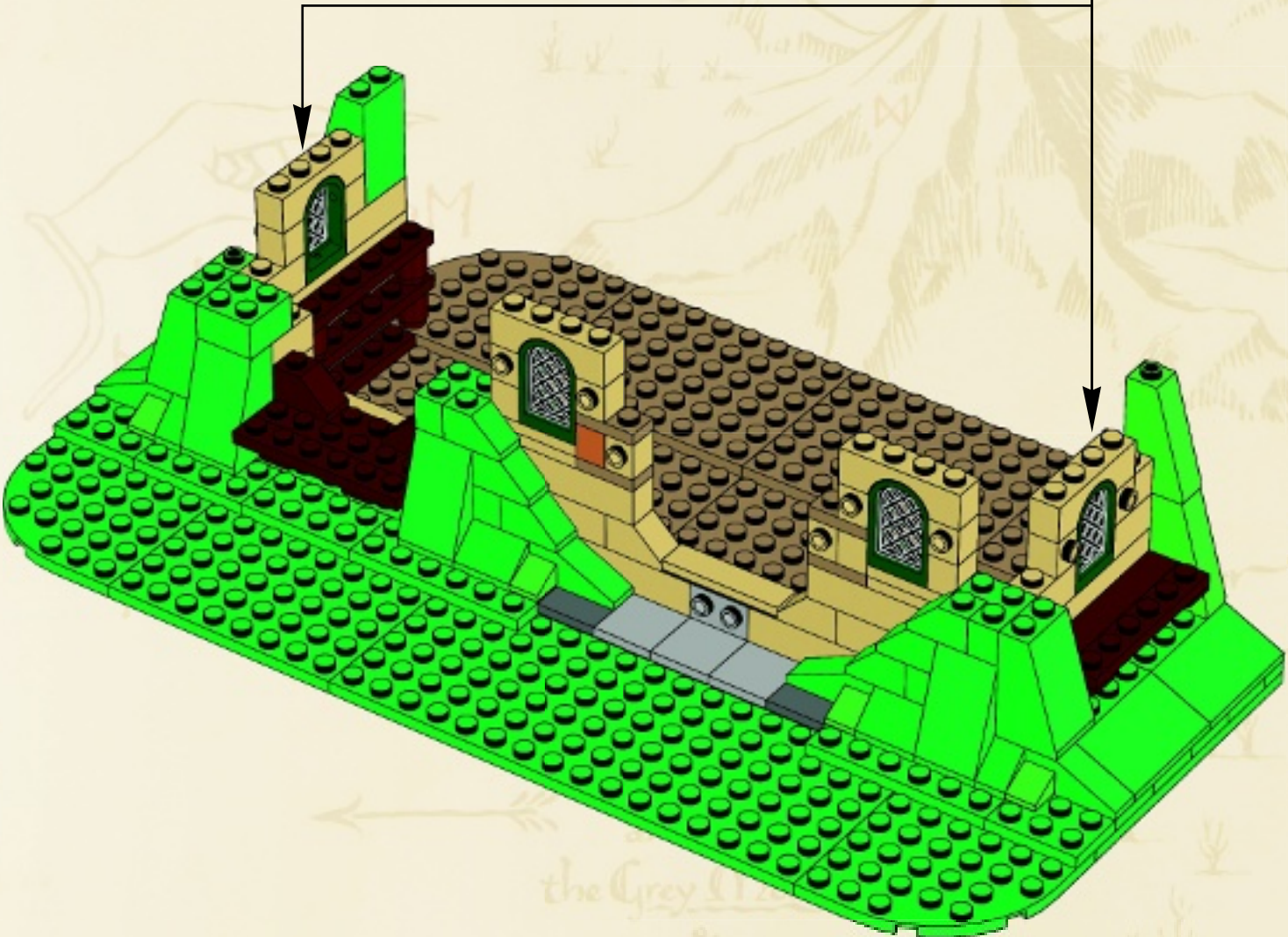
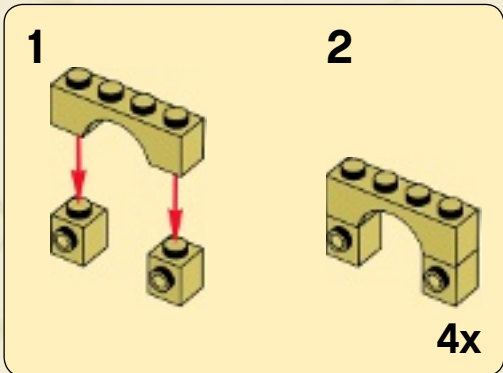



1x



2x

50

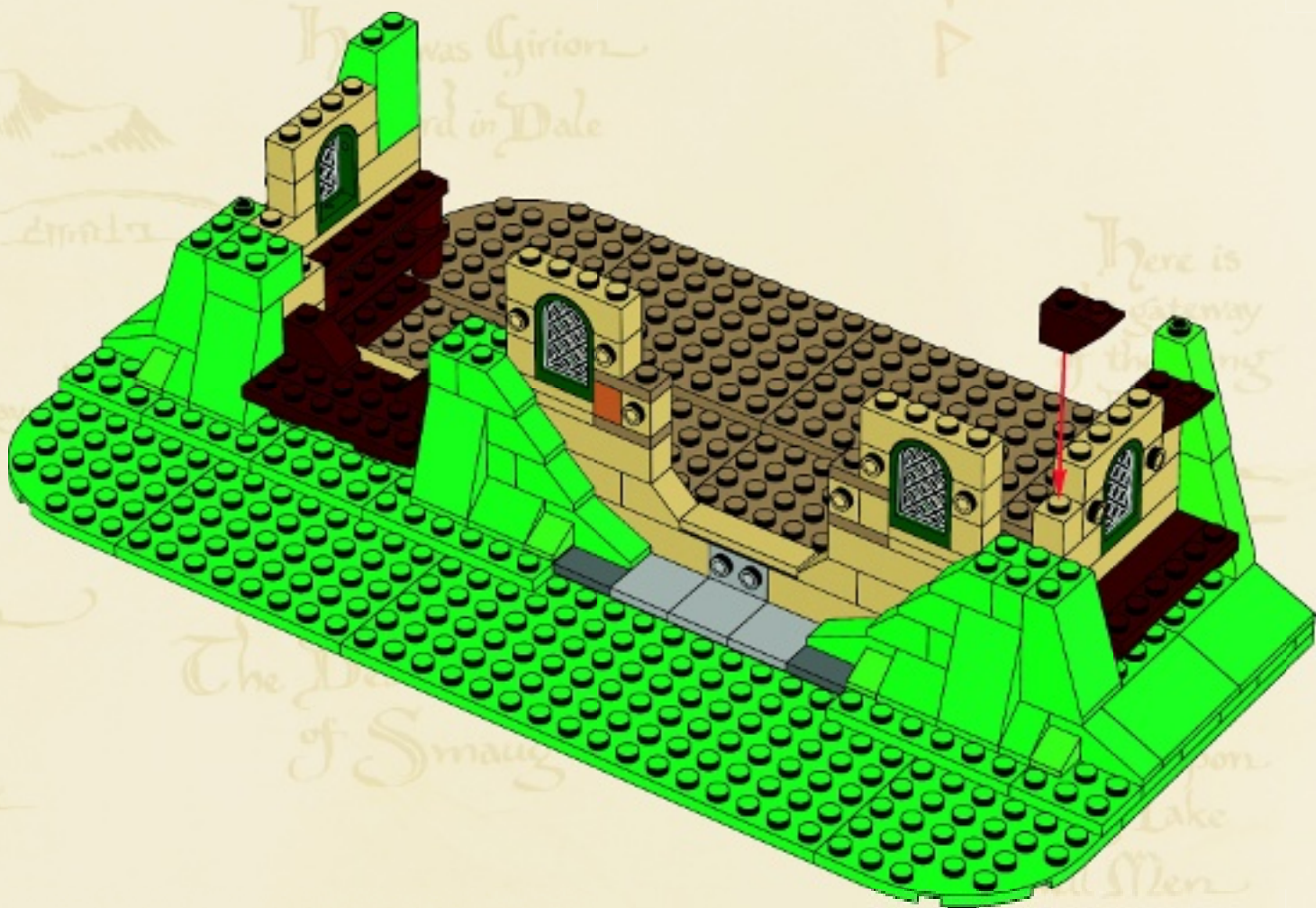

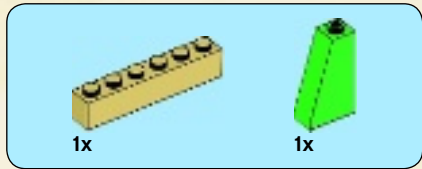

51

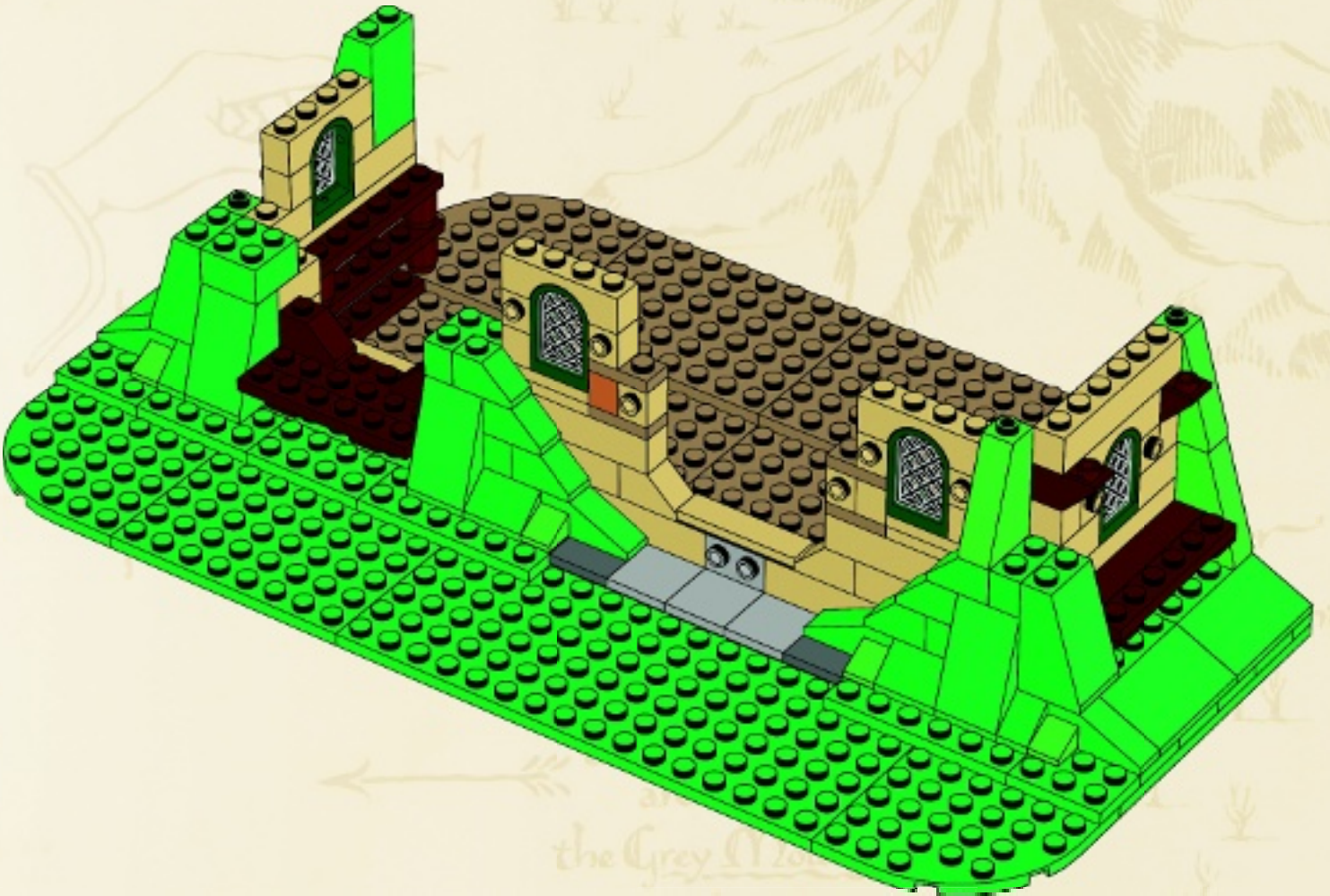

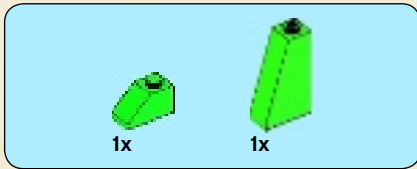

52

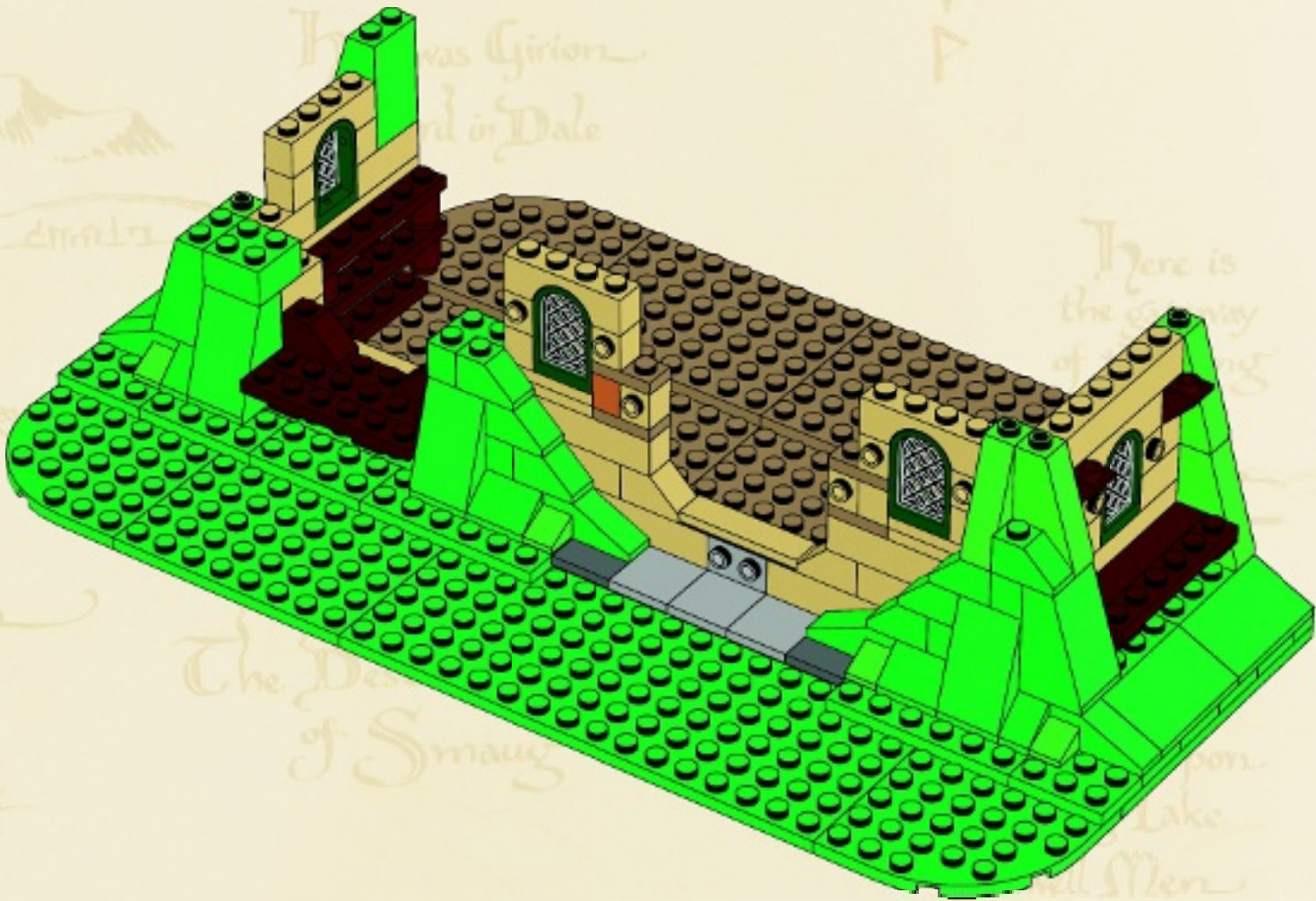

1x  2x 

# 53

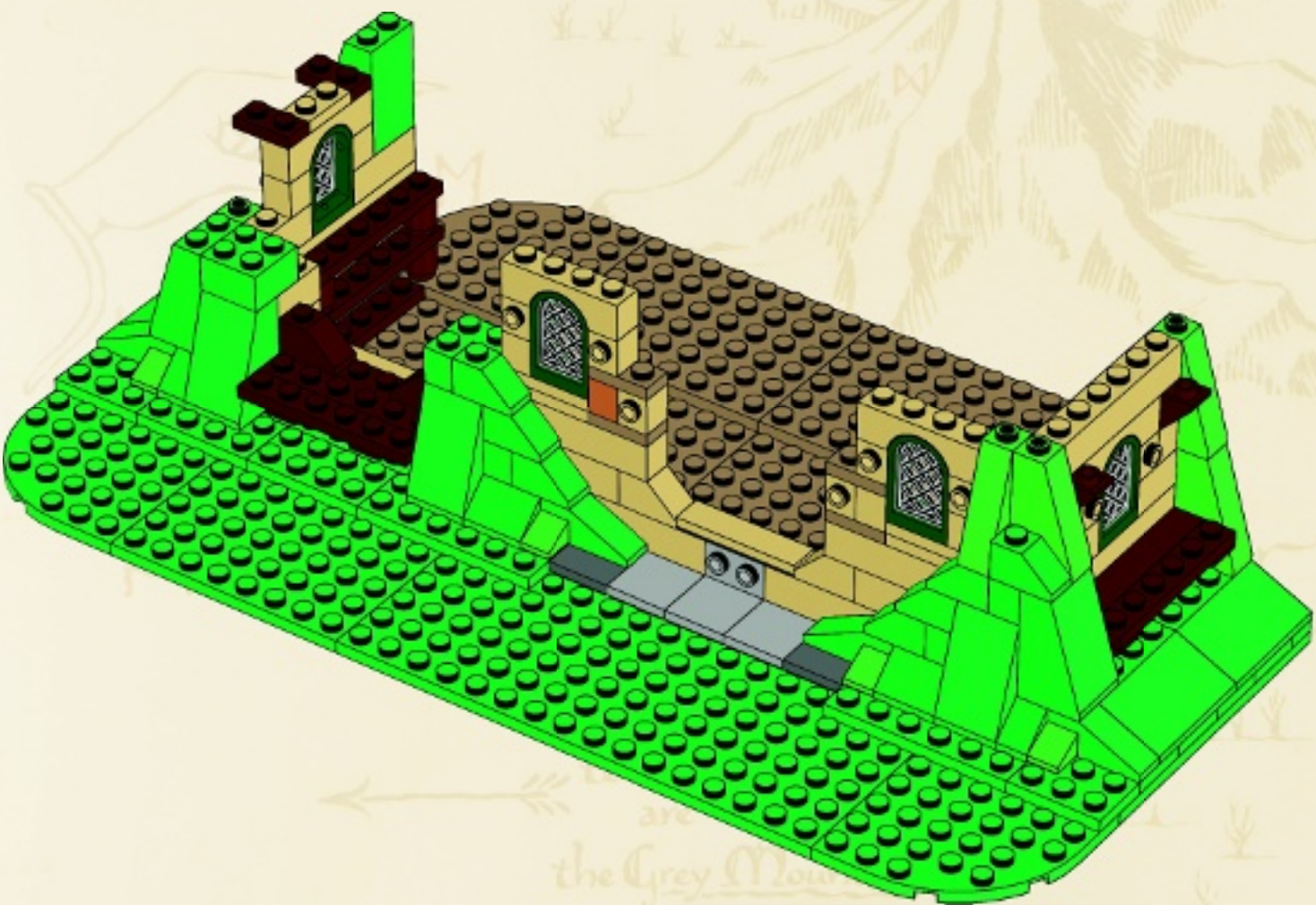



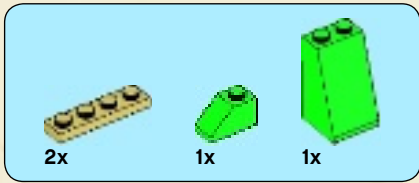

54

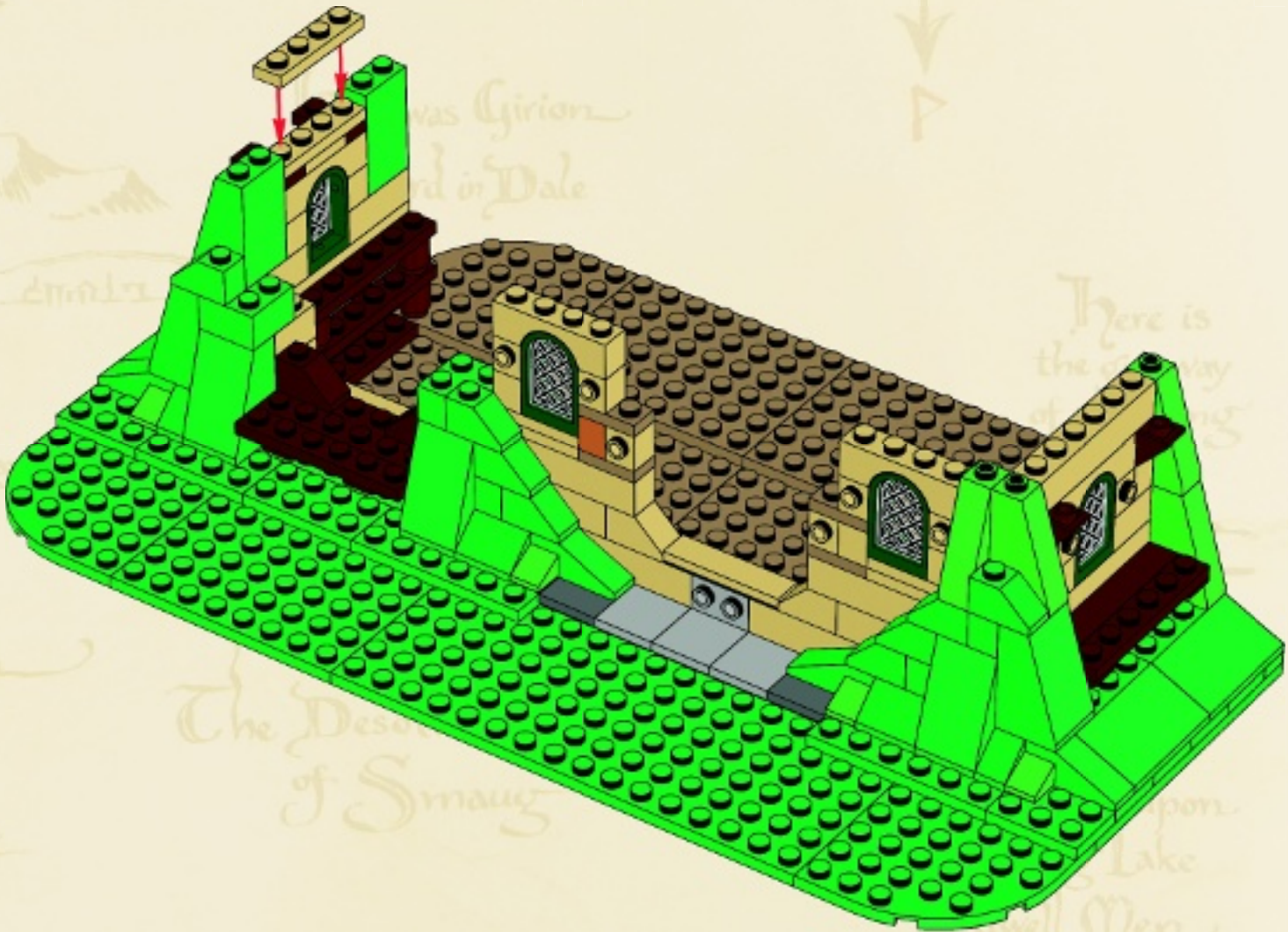

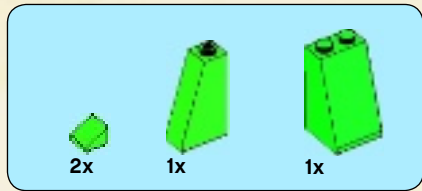

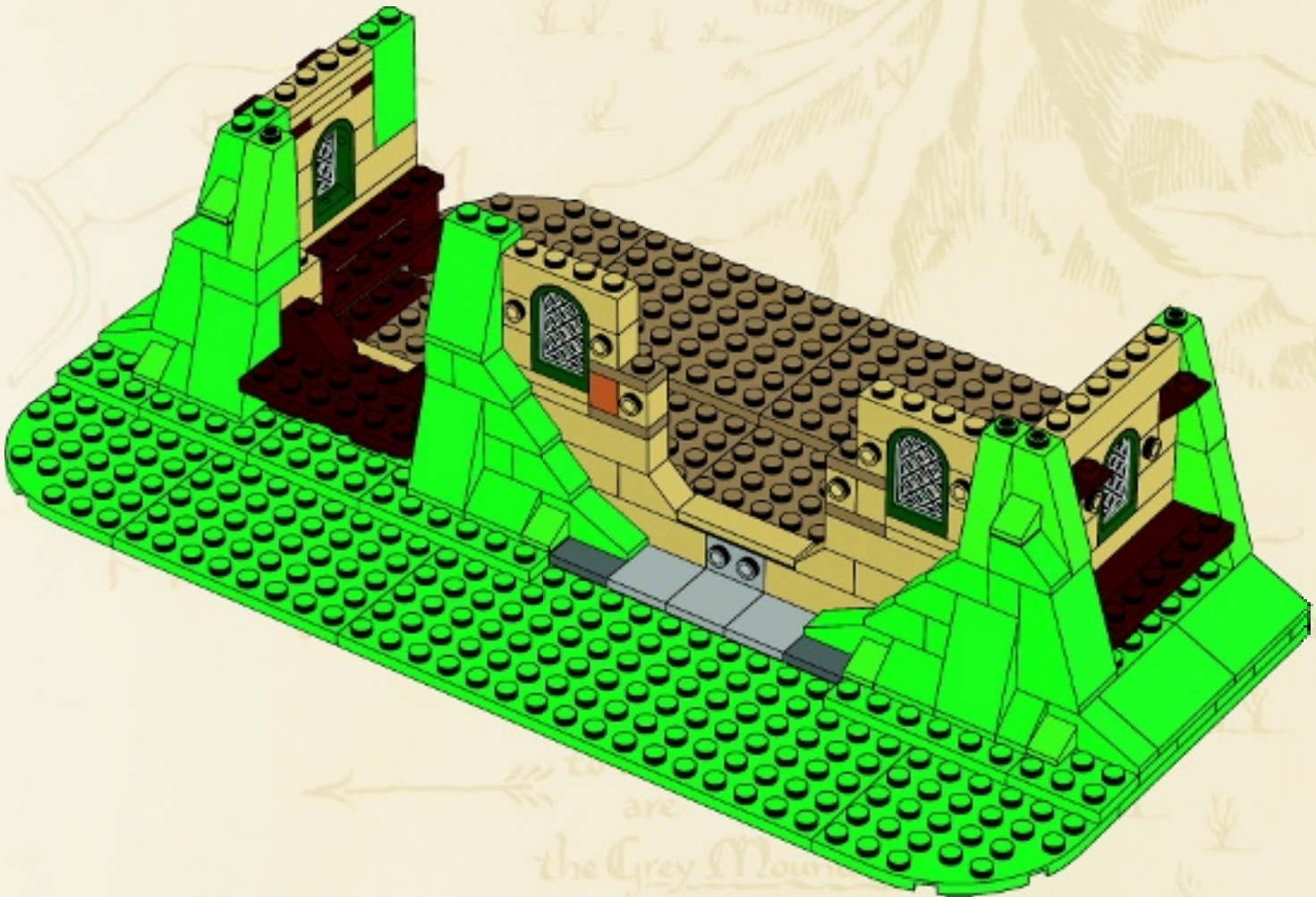

55

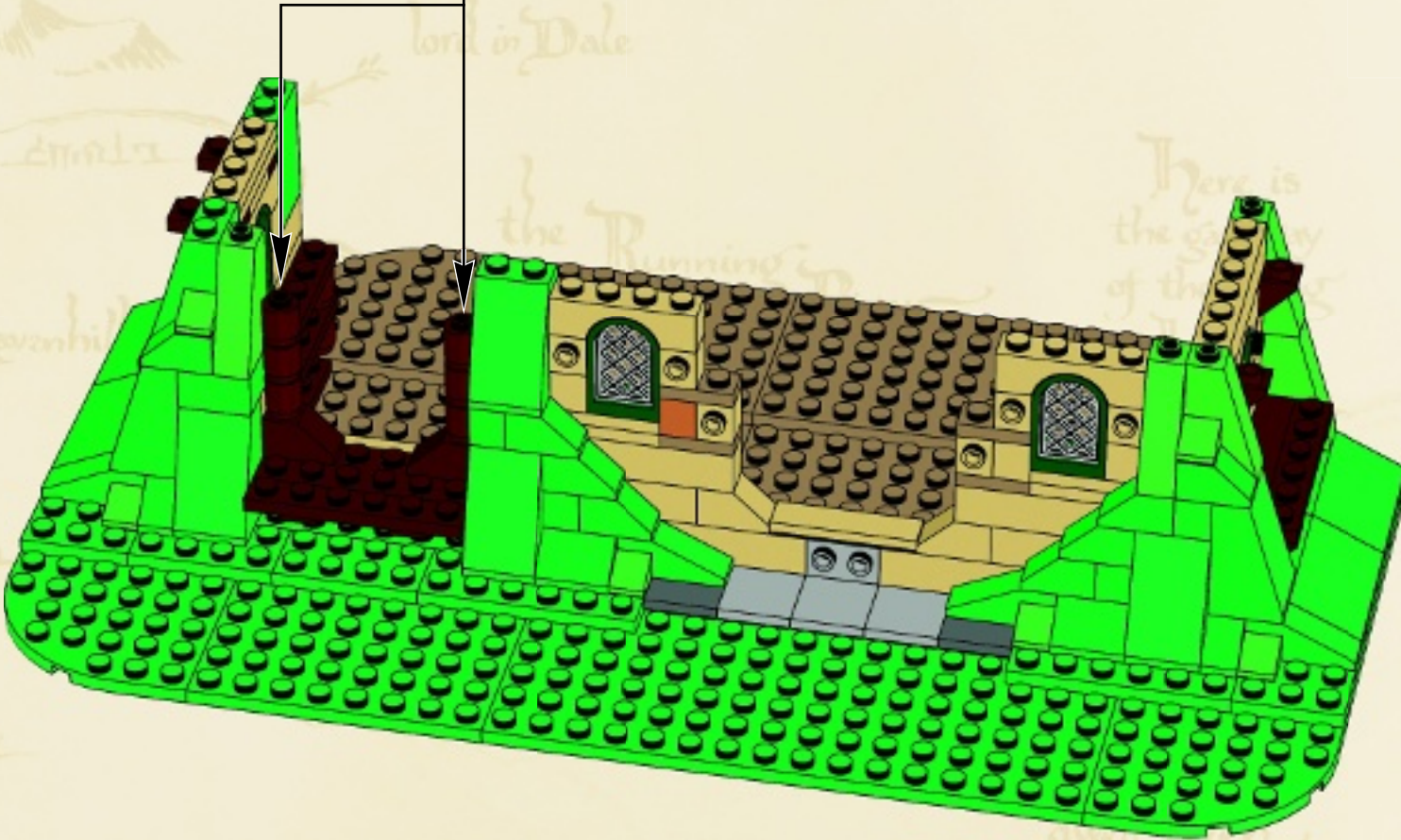
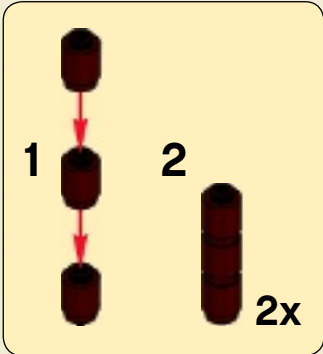

6x

# 56



2x  1x 

# 57

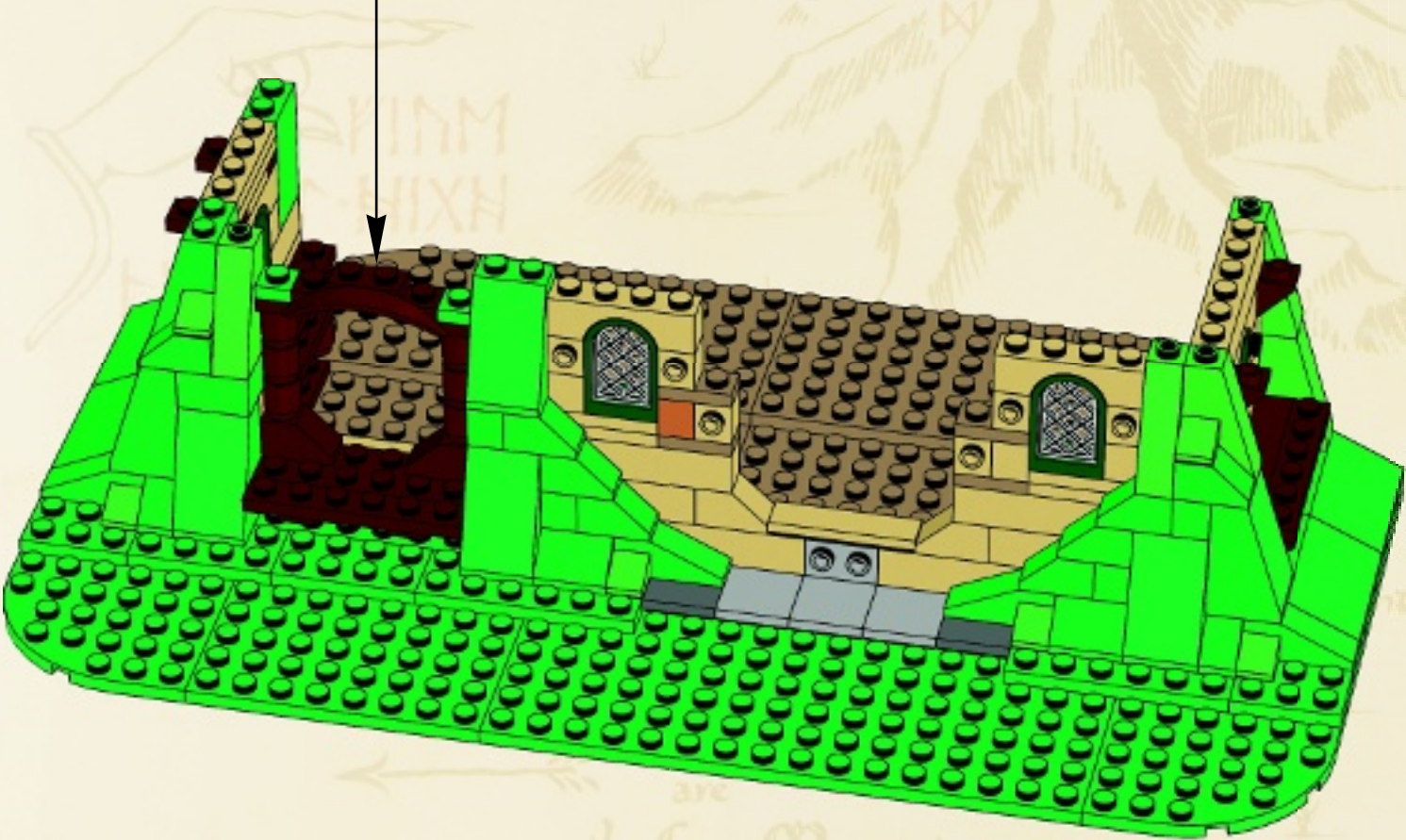

1 

2 





The  
 Lovely  
 Mountain

are  
 the Grey Mountains  
 &  
 the Withered Heath  
 whence came the

 2x	 2x	 4x
--	--	--

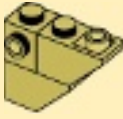
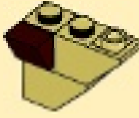
# 58

- 1 
- 2 
- 3 

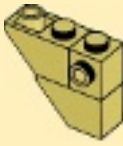
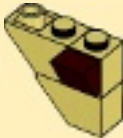
- 1 
- 2 
- 3 

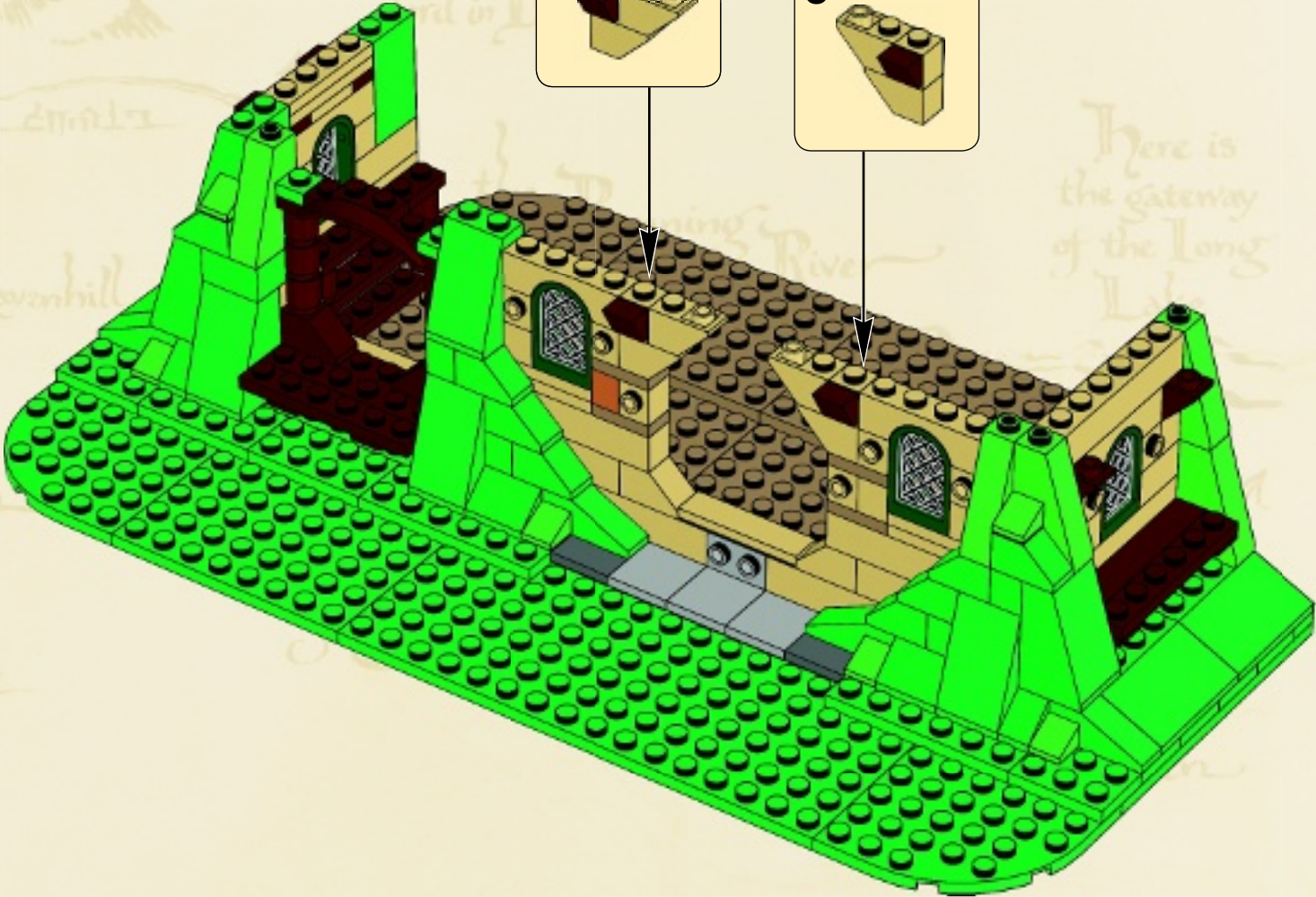

2x

59

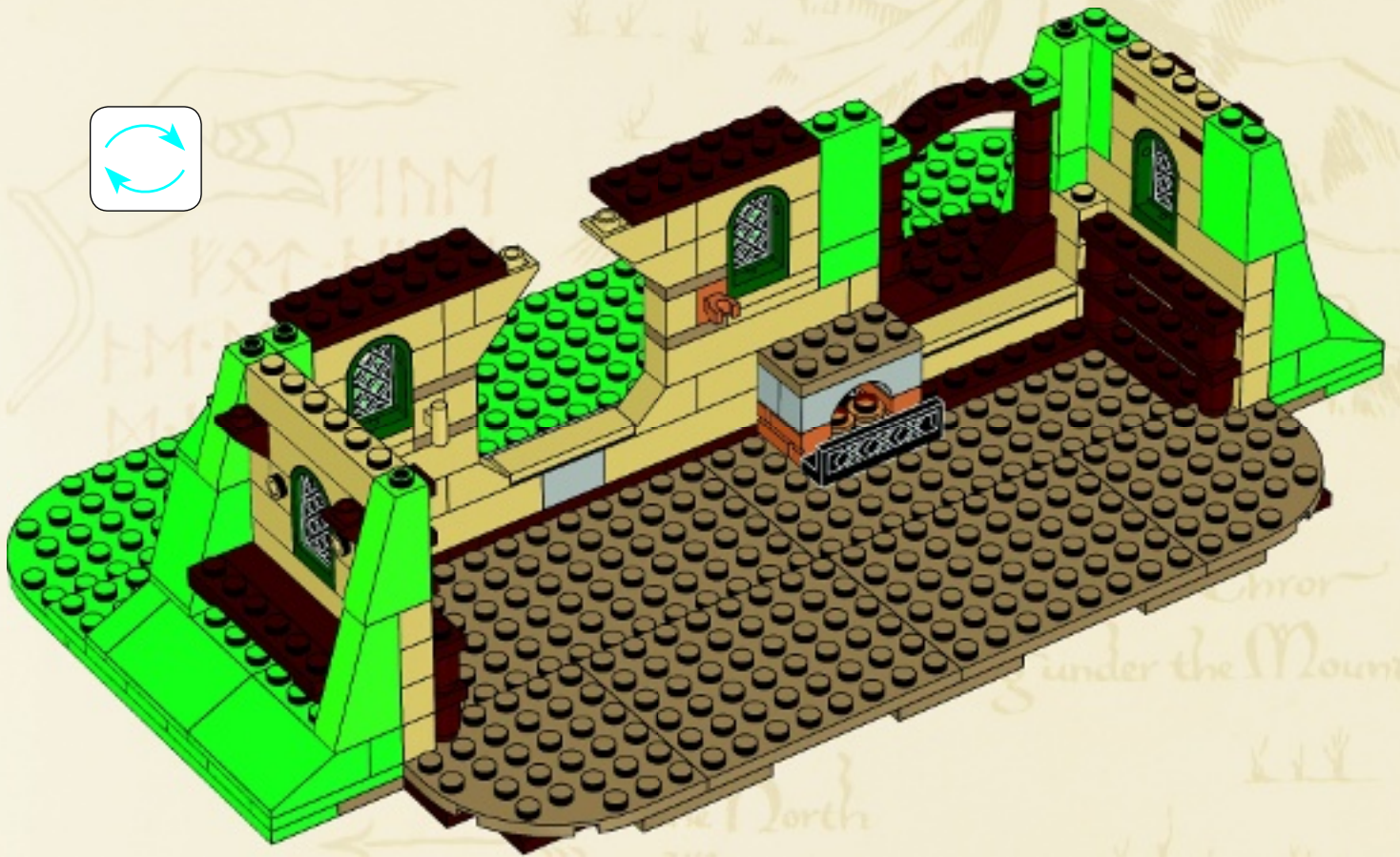



# 60

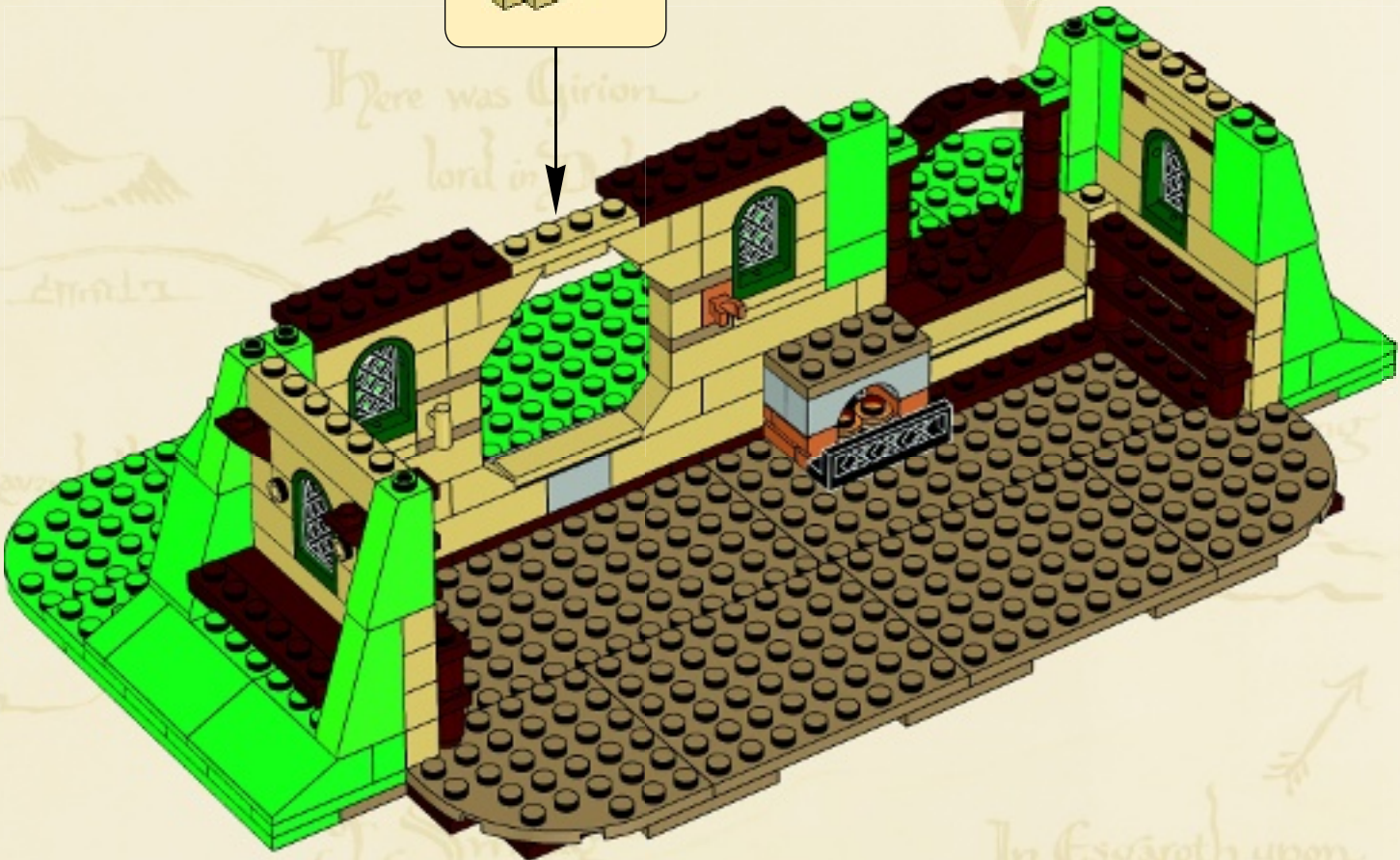
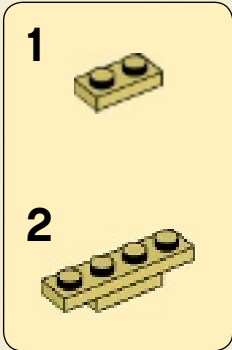

*In Esgaroth upon  
the Long Lake  
dwell Men*

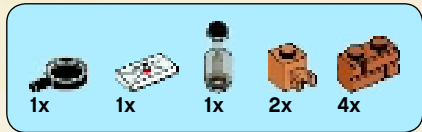

# 61

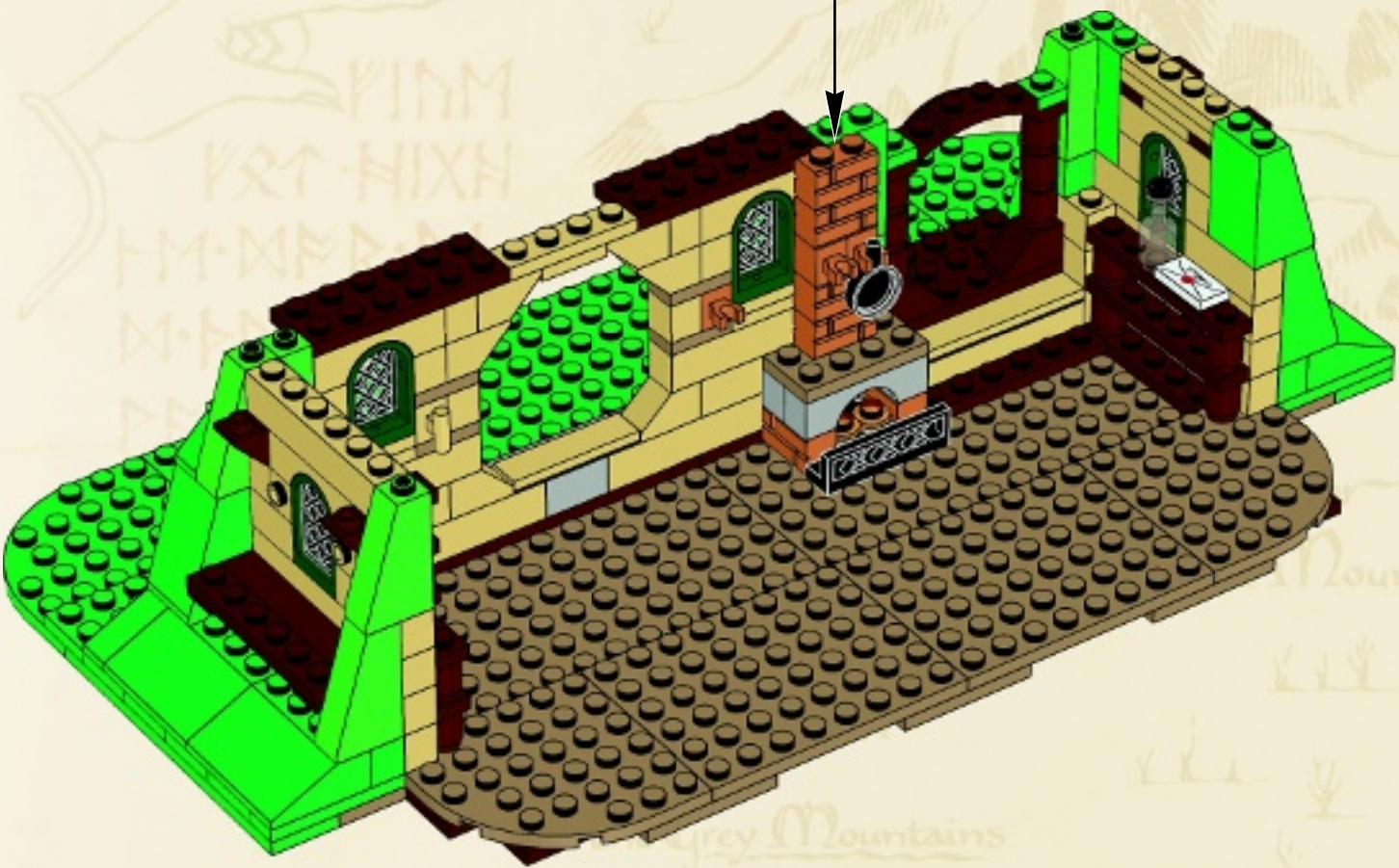
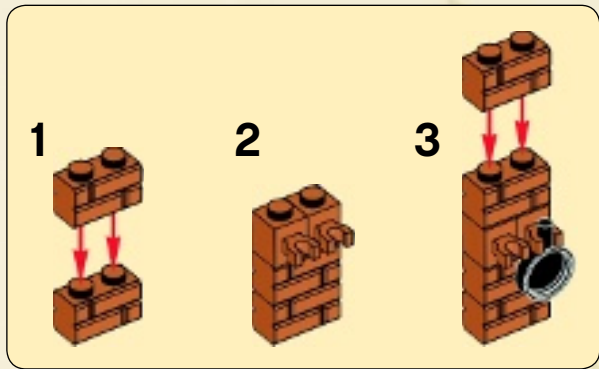



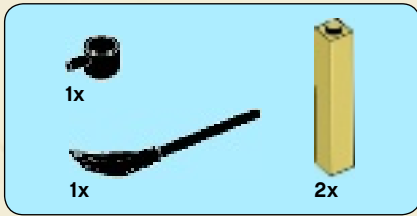

62

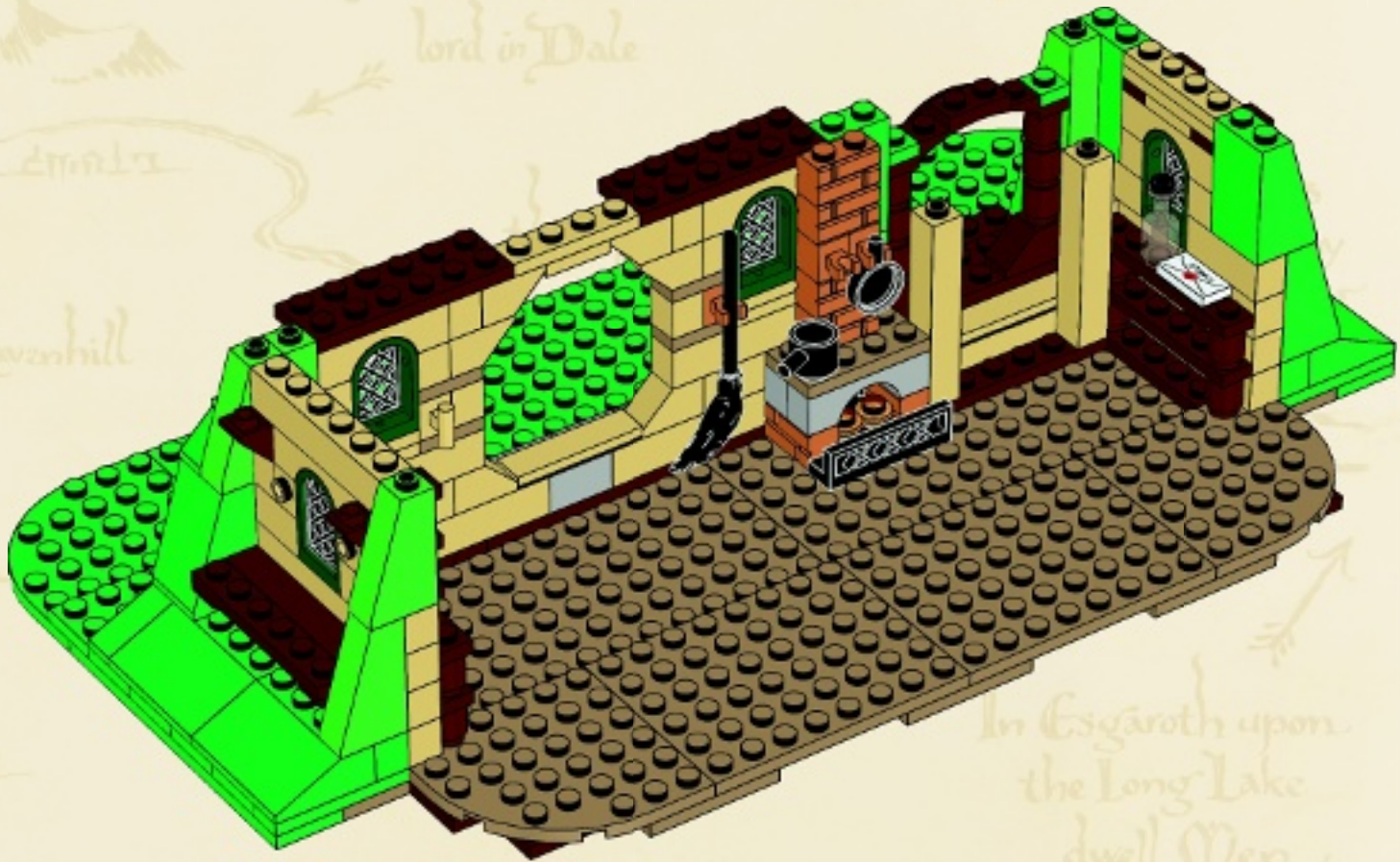

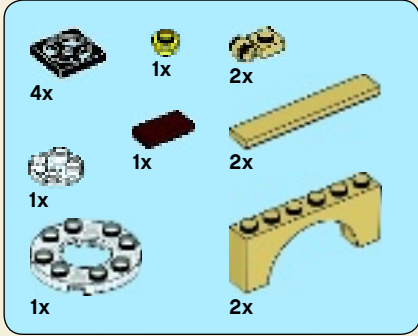

# 63

1



2



3

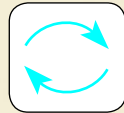

4



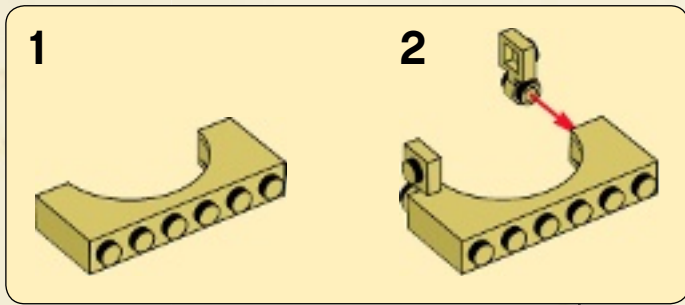

**5**

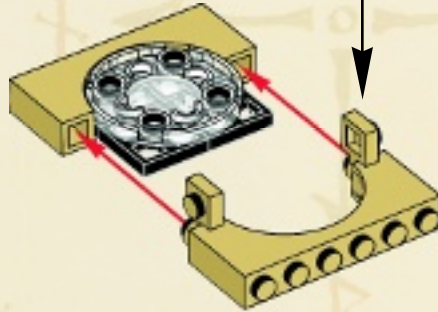

**6**



**7**

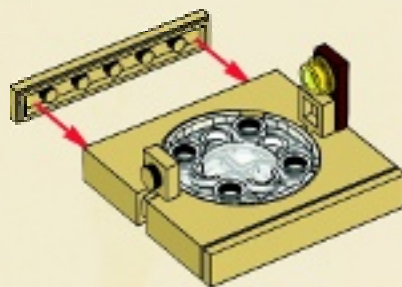

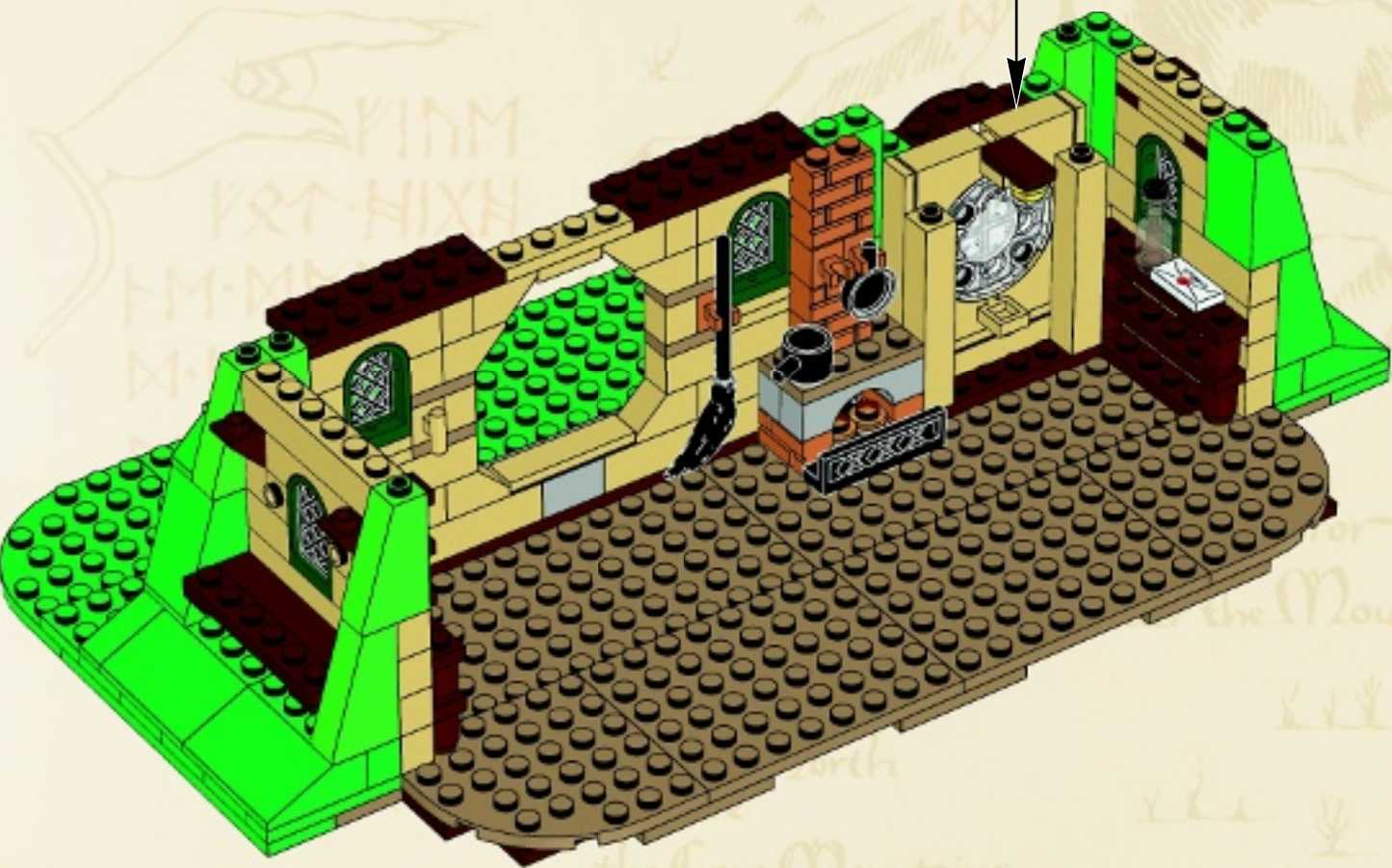
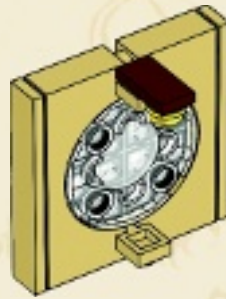
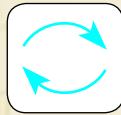



2x

64

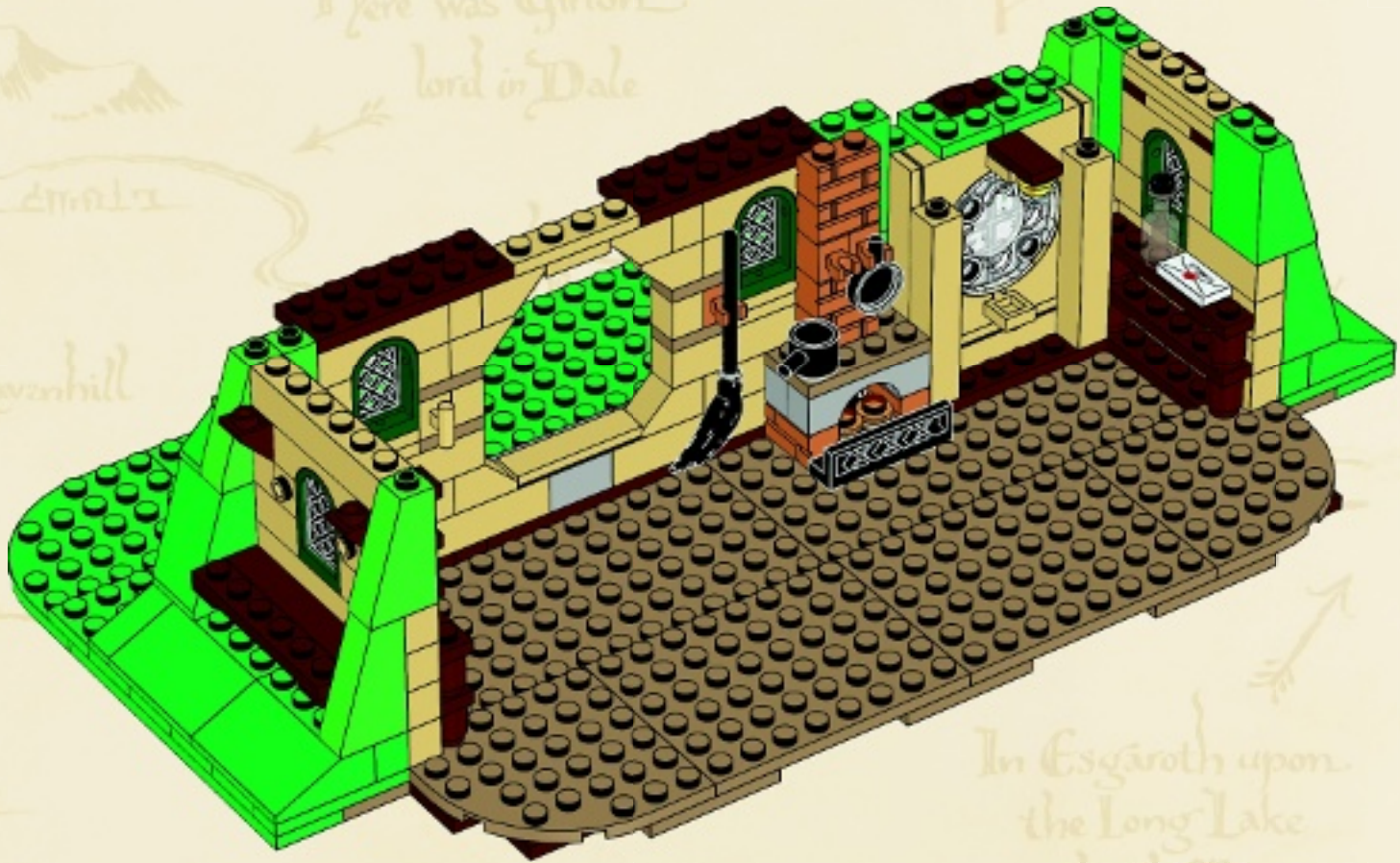

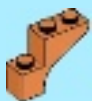

2x

# 65

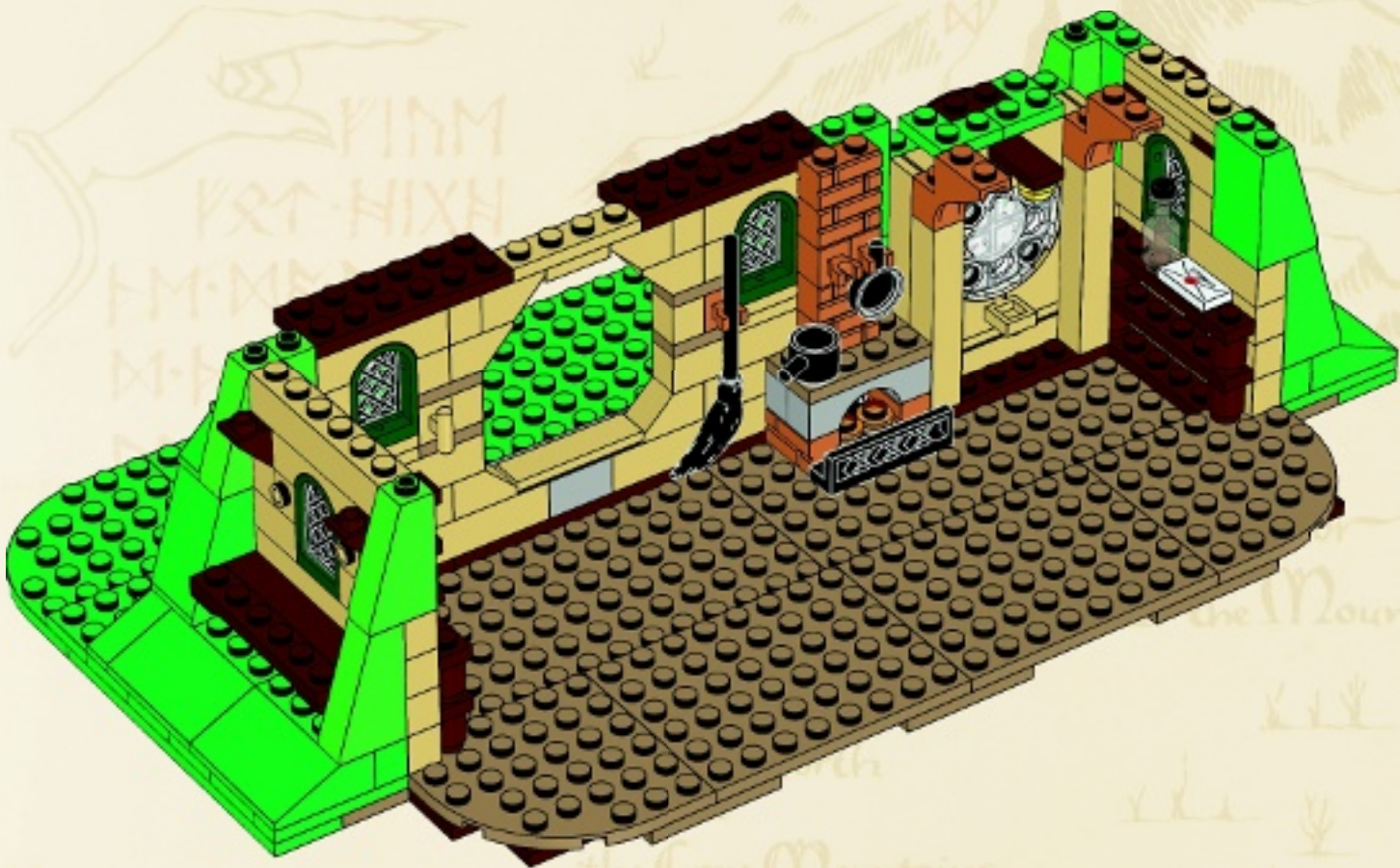

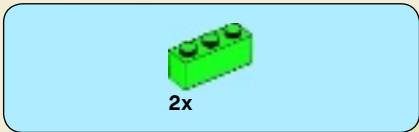

66

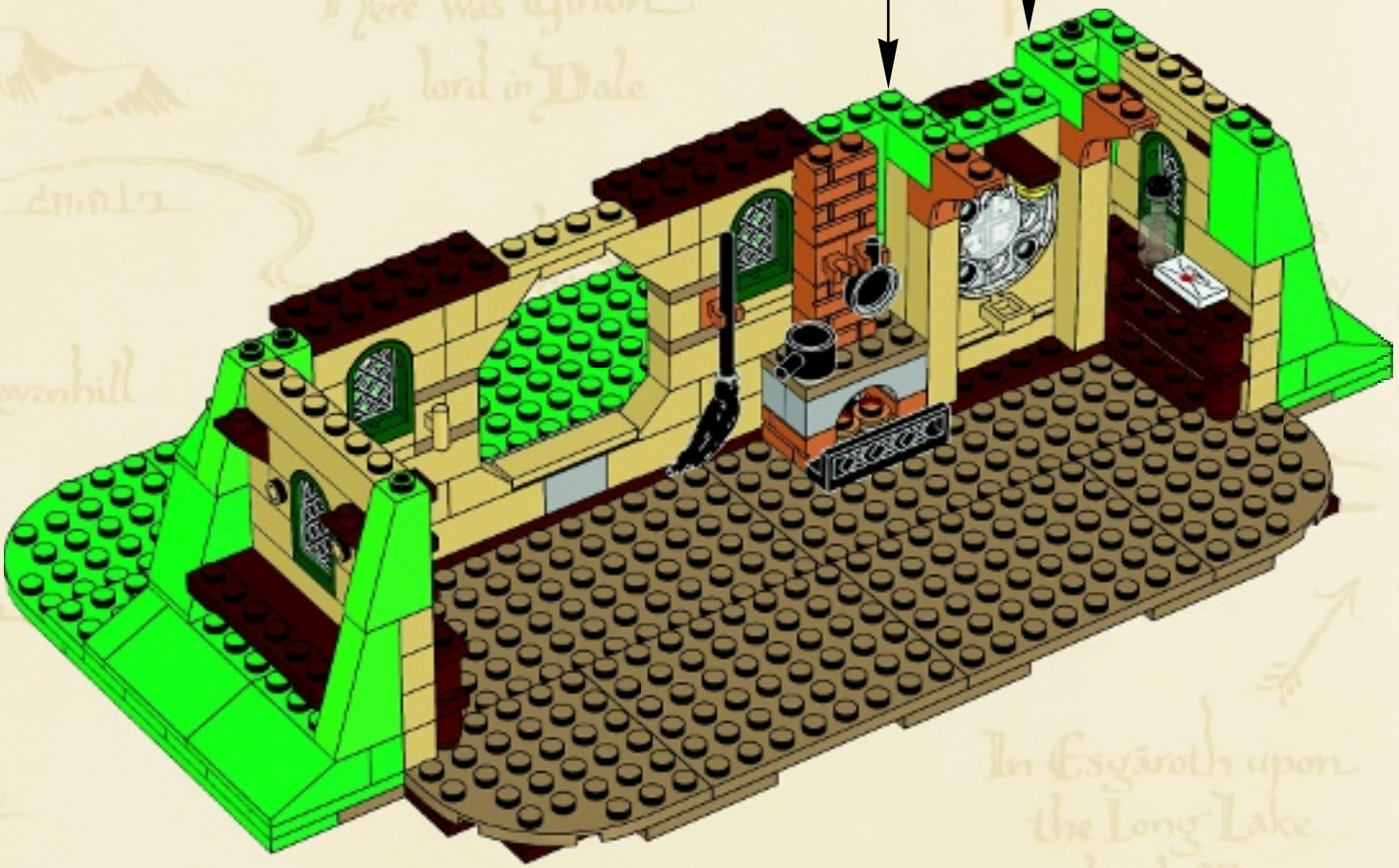
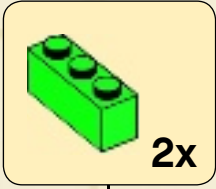



2x

67

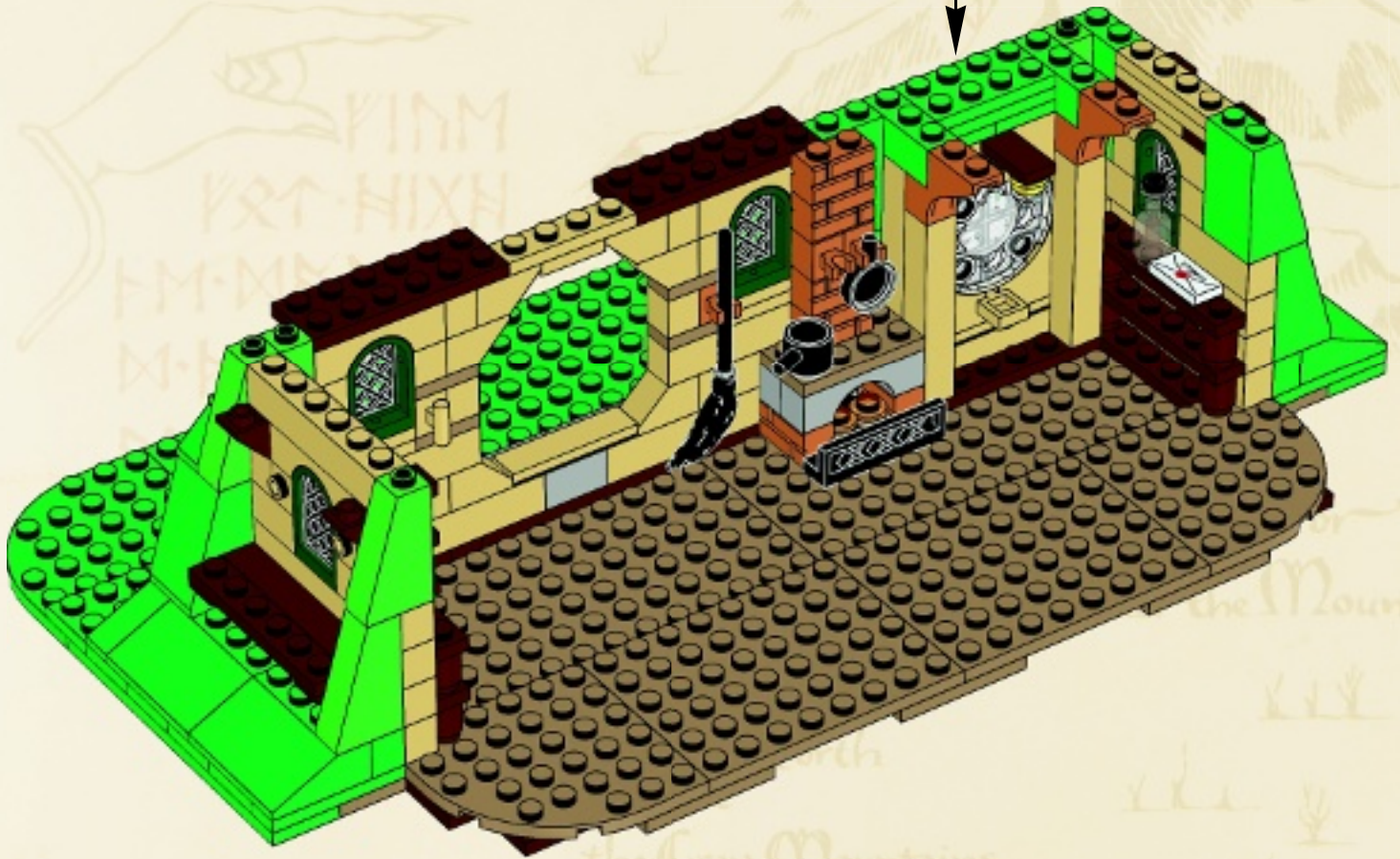
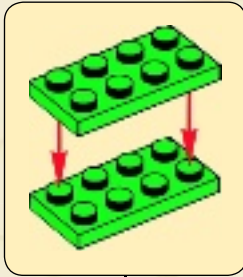



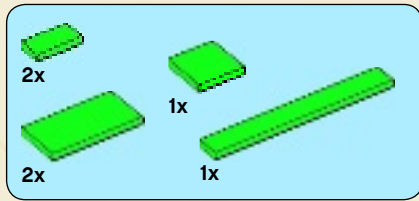

68

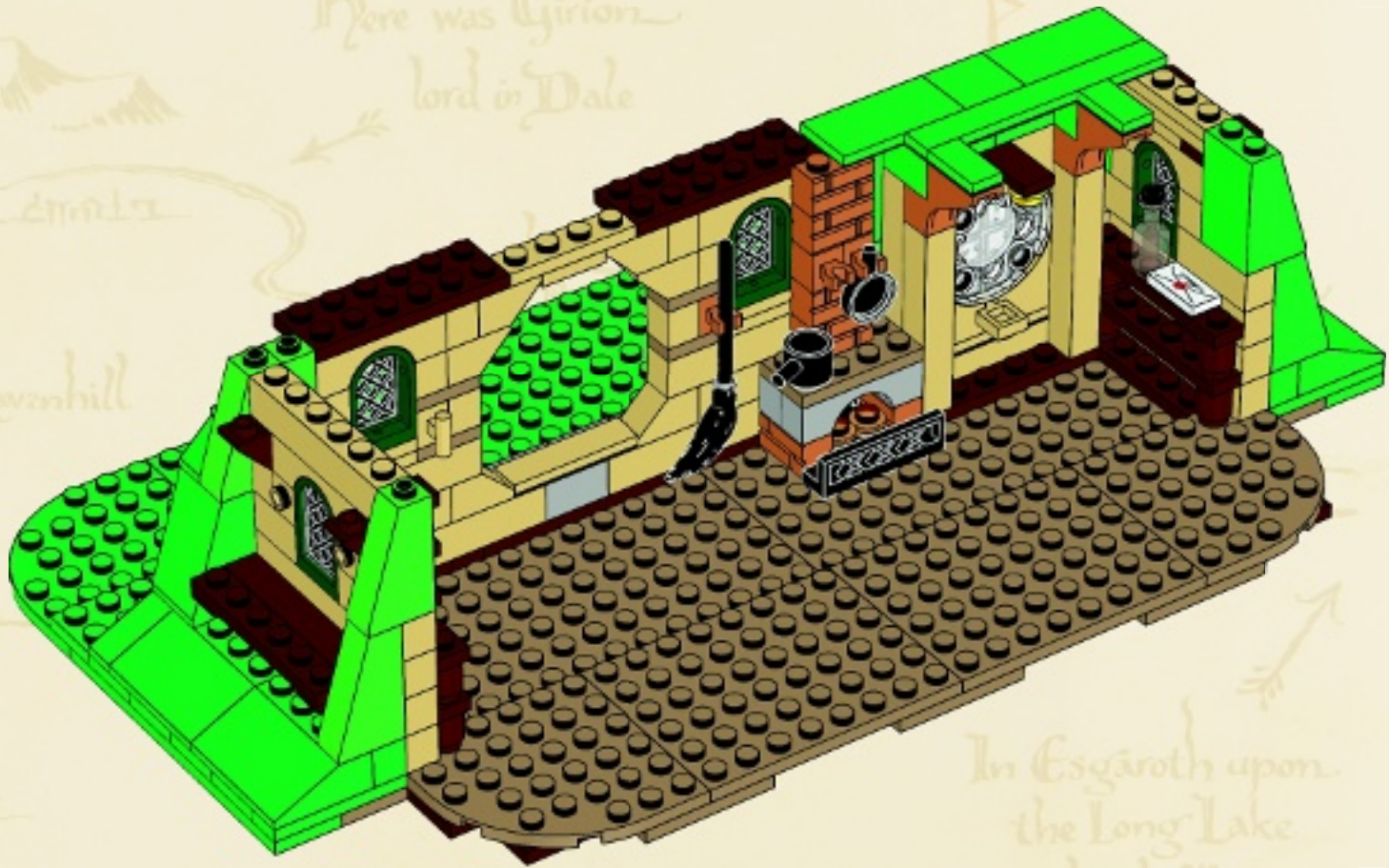



# 69

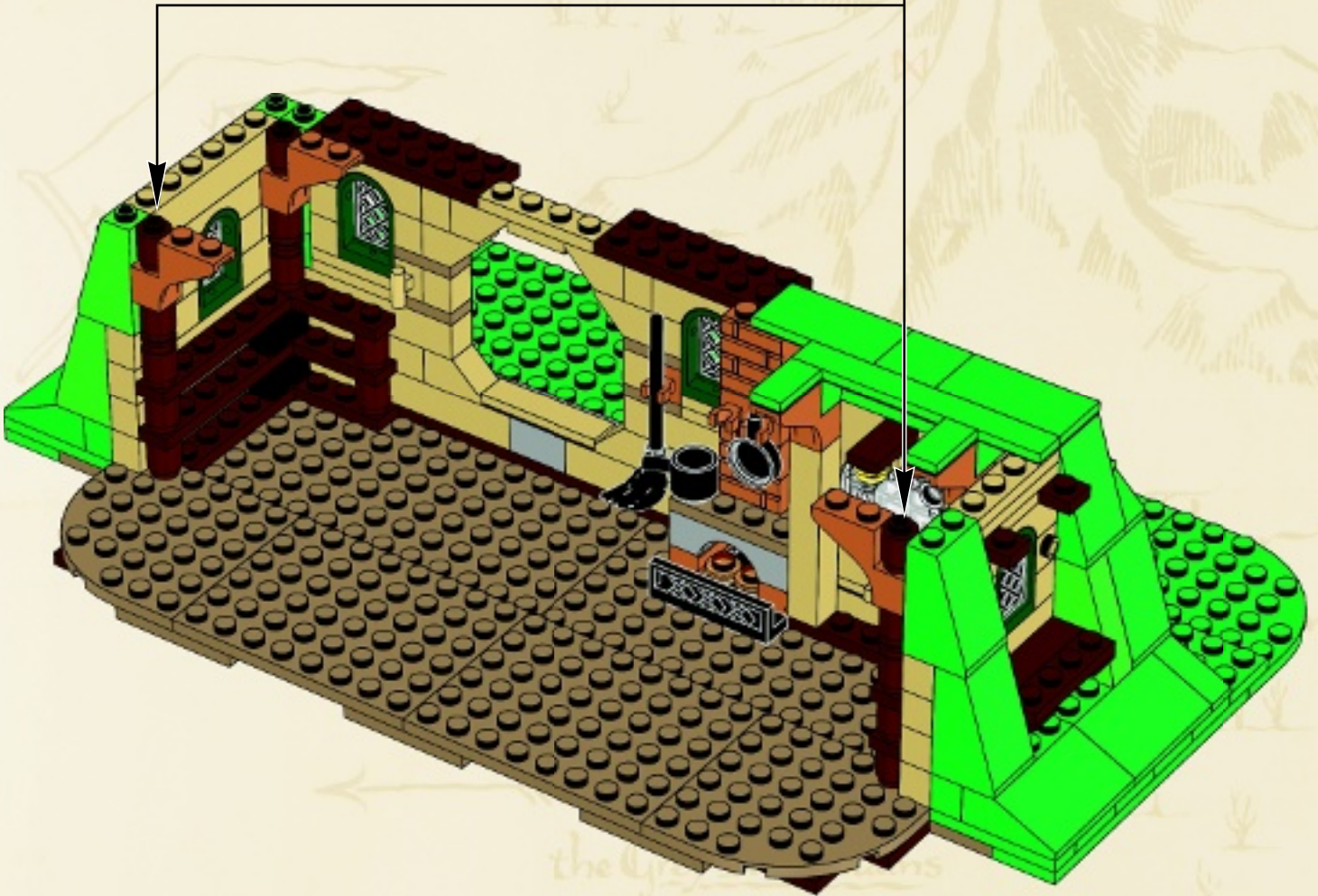
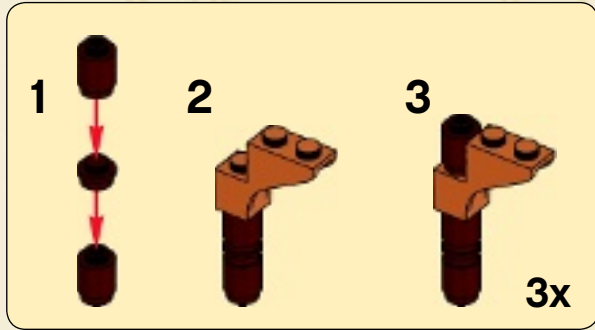

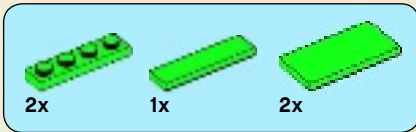

70

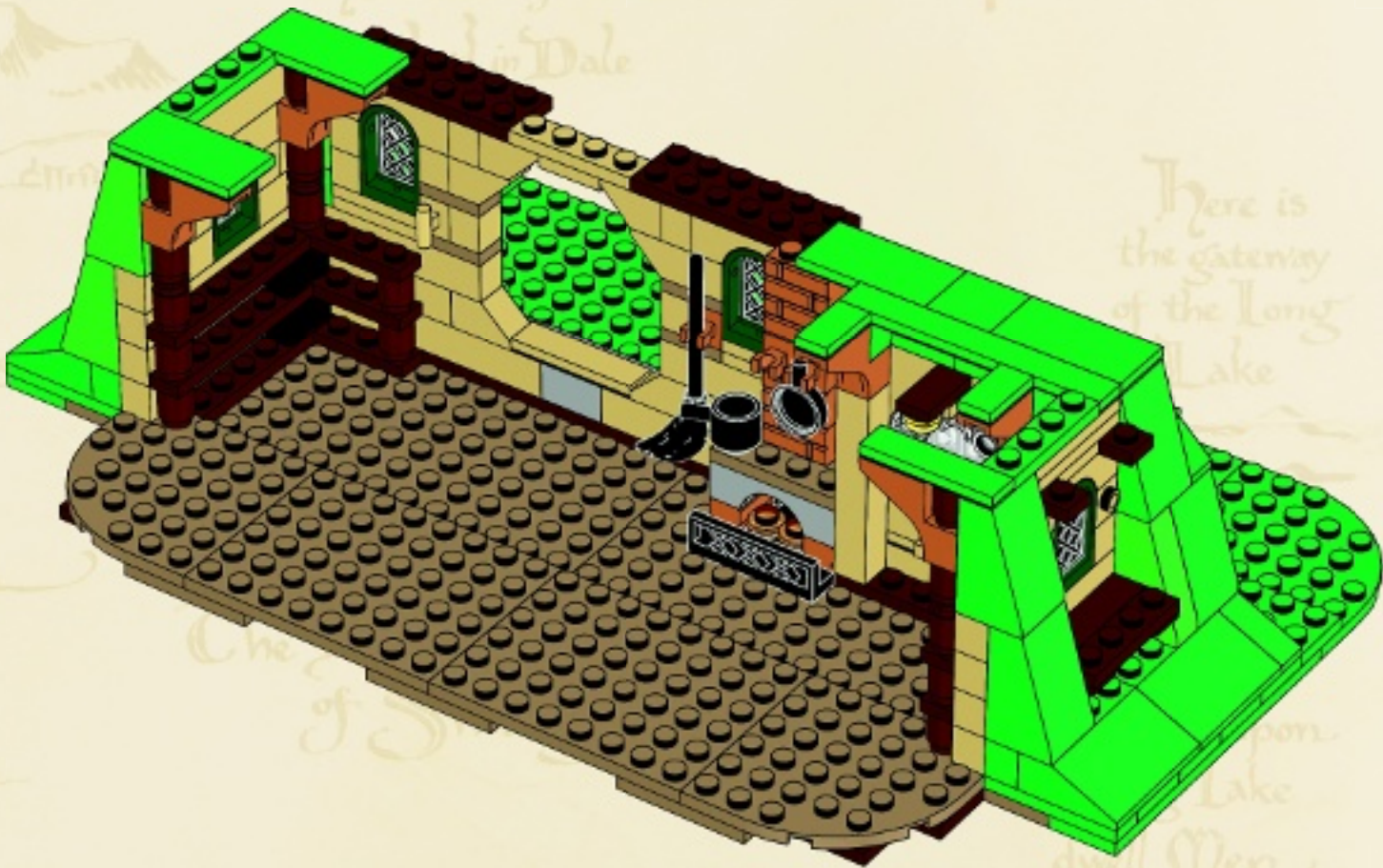

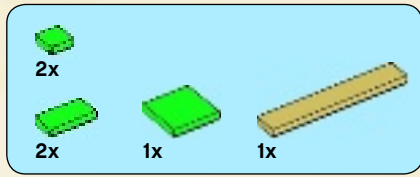

71

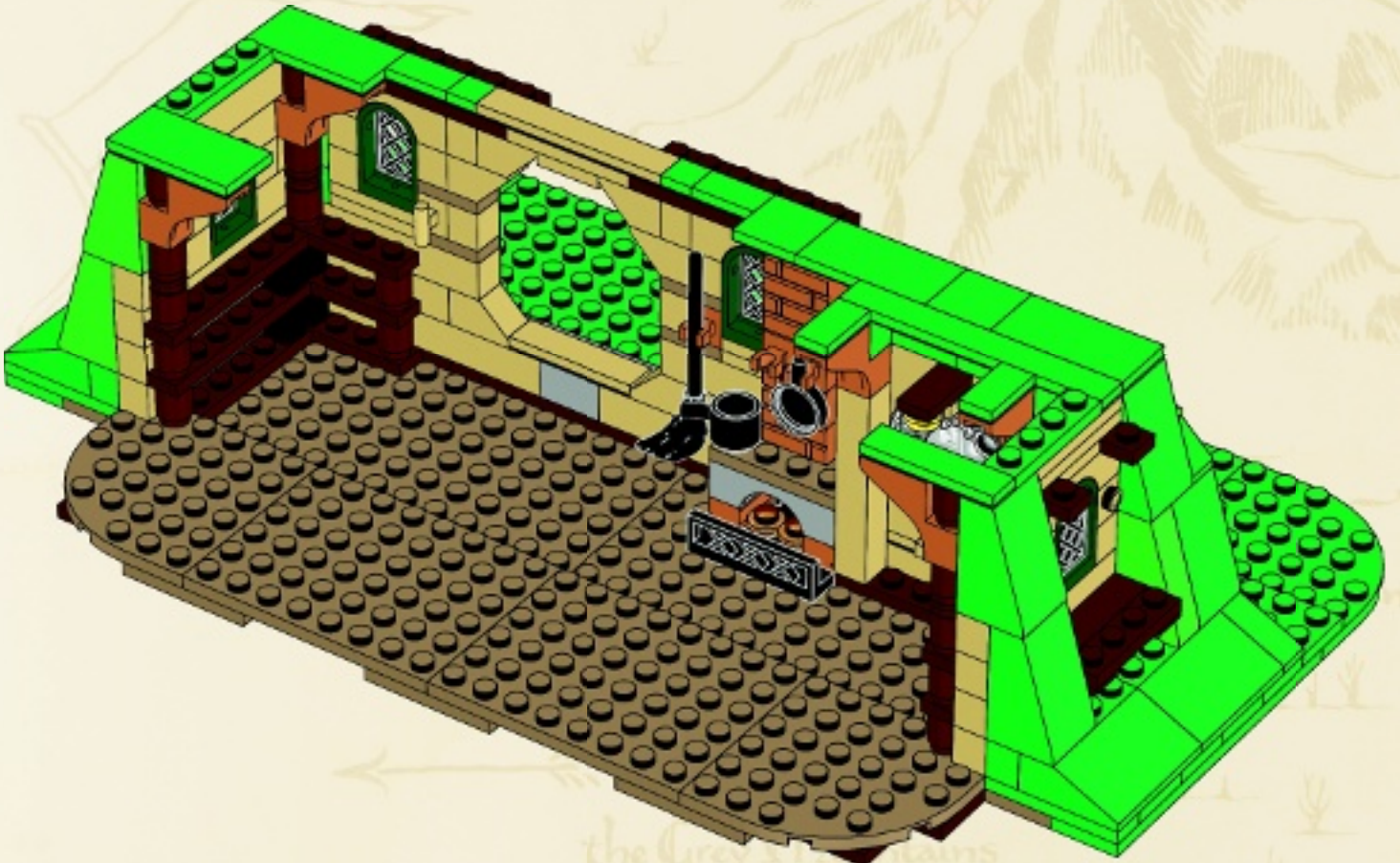

*the Grey's...  
&  
the Withered Heath  
whence come the*

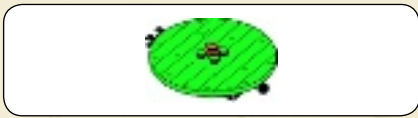

1

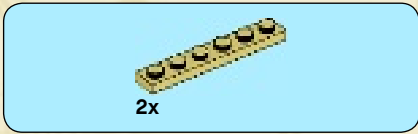
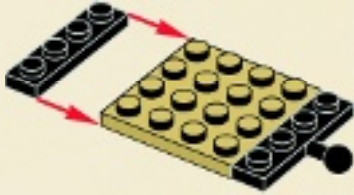

2

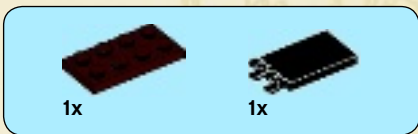

3

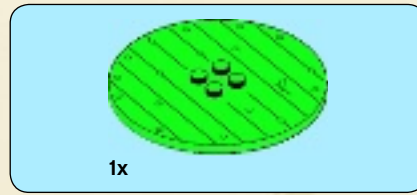
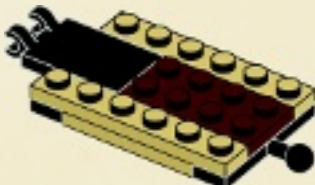

4

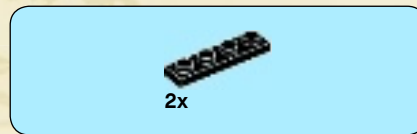
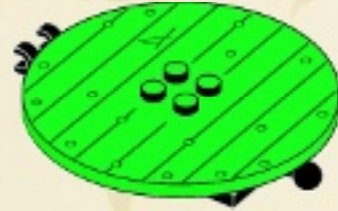

5

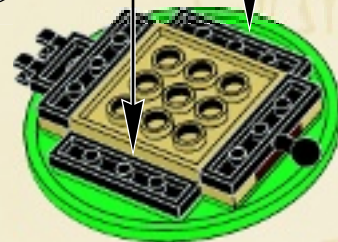
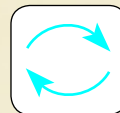
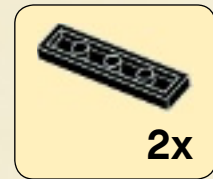





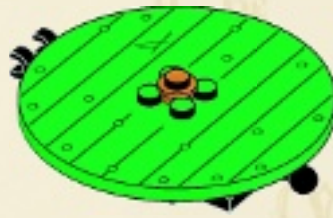
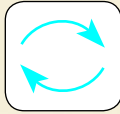

1x

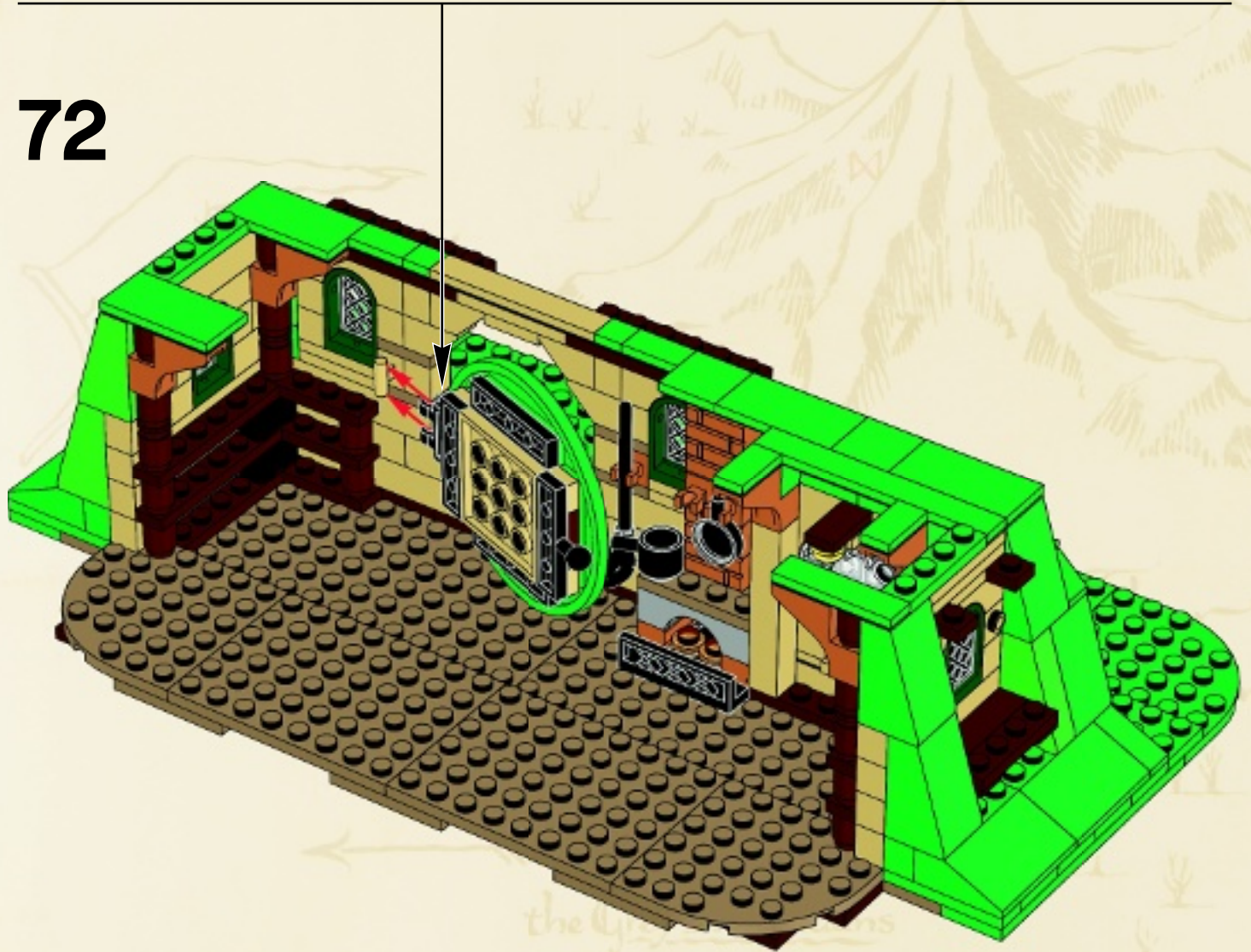
6



72



-   
1x
-   
2x
-   
1x
-   
1x
-   
1x

# 73

- 1** 
- 2** 

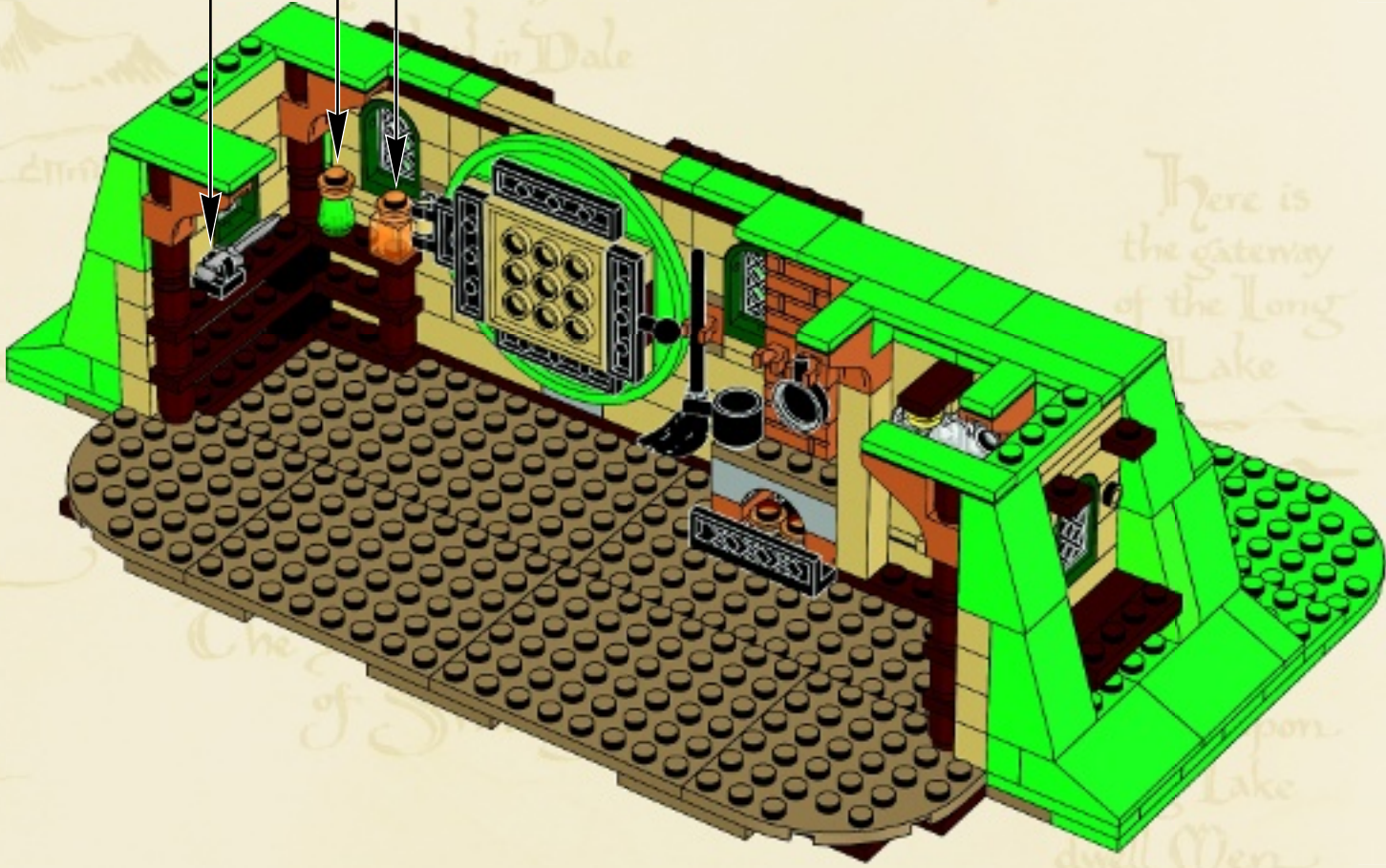

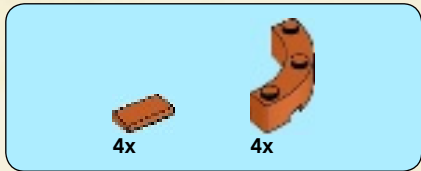

# 74

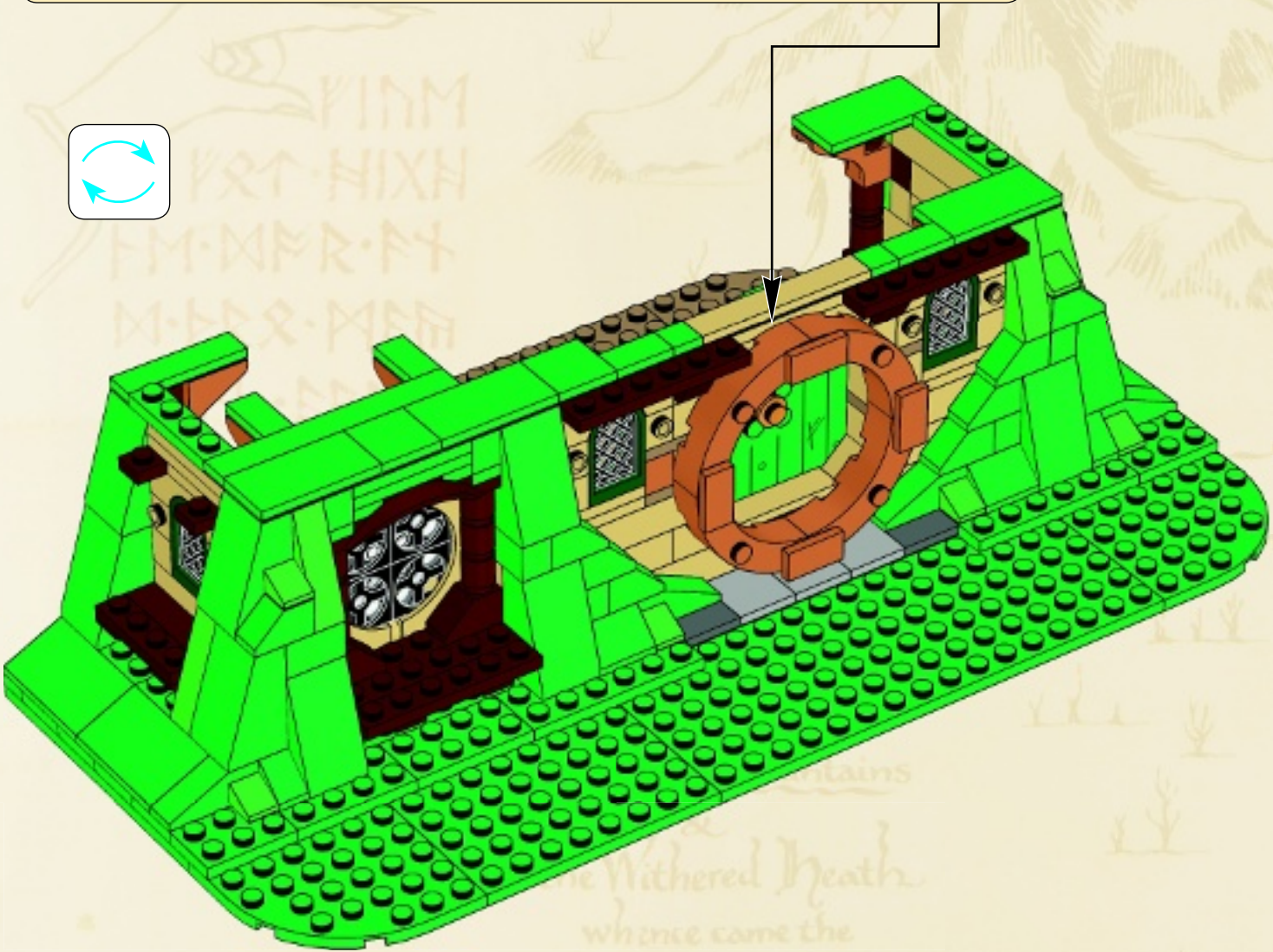
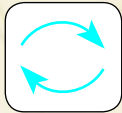
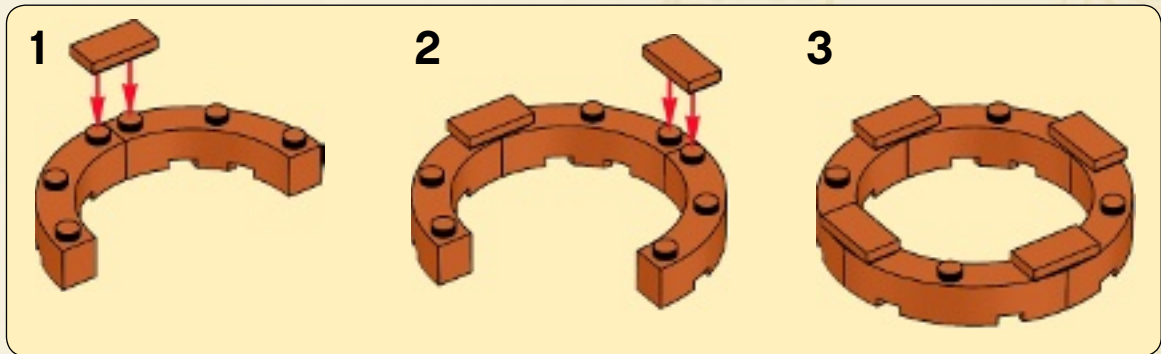





# 75

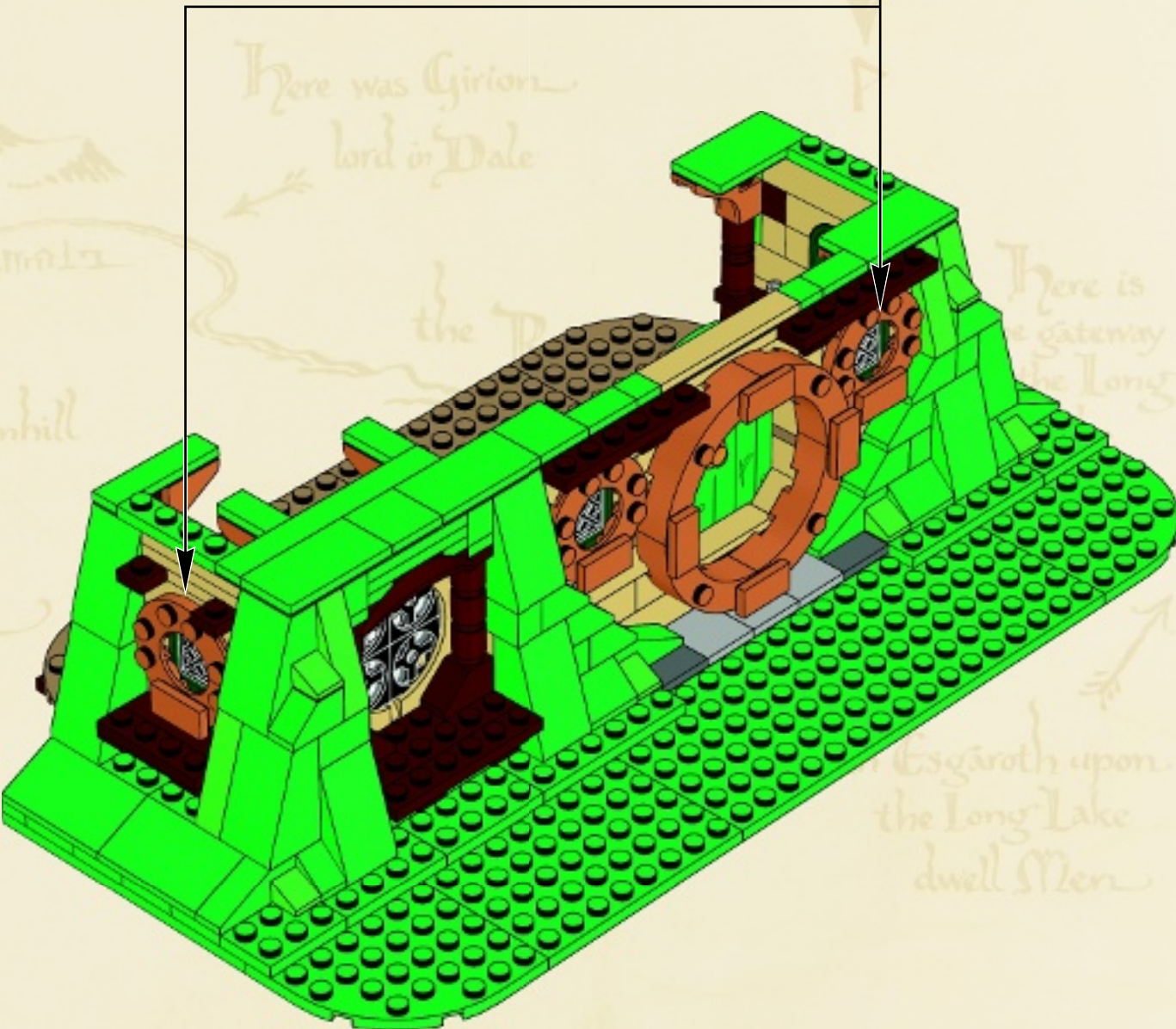

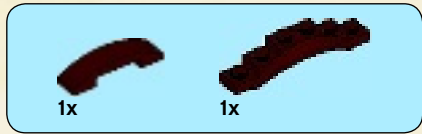

76

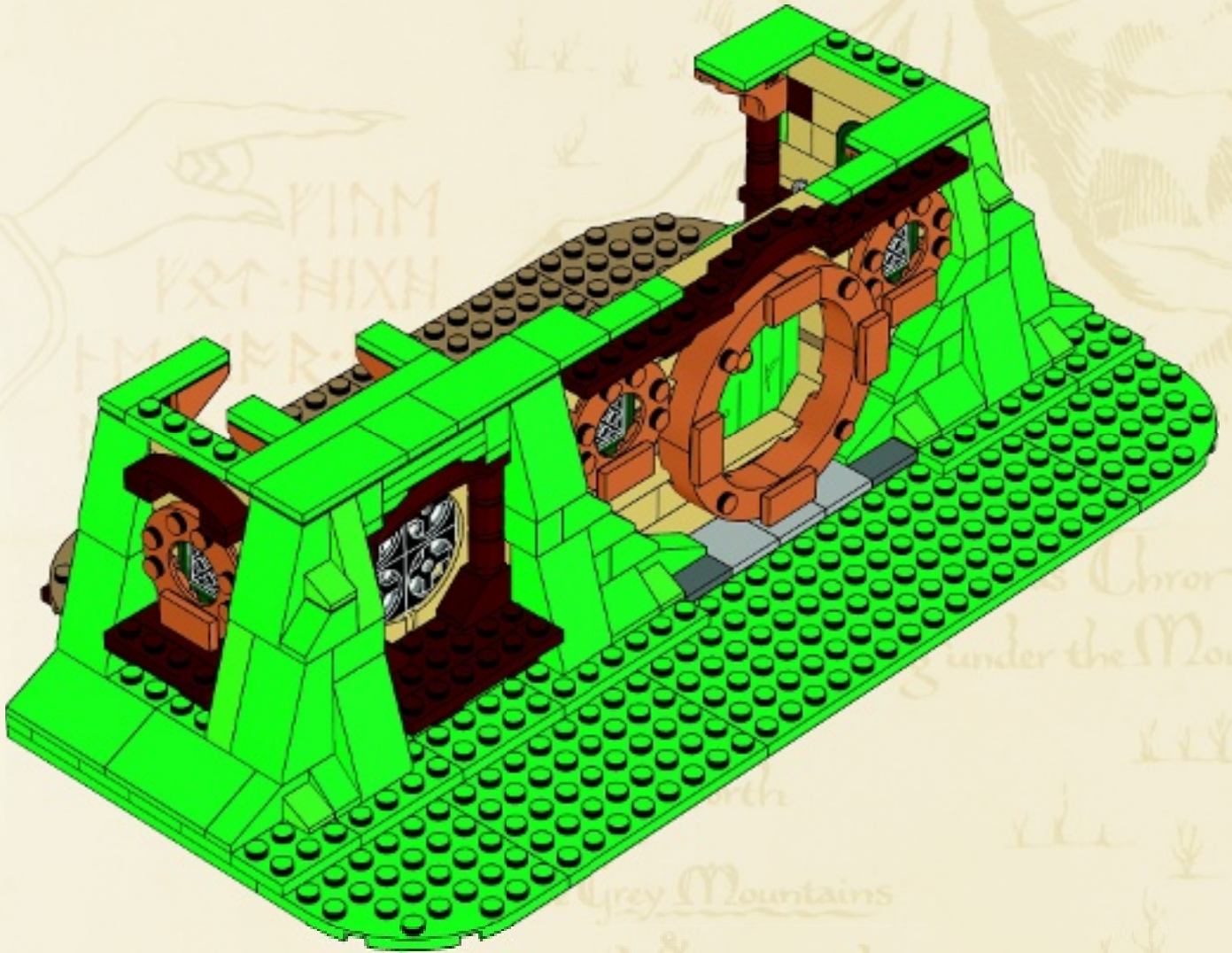

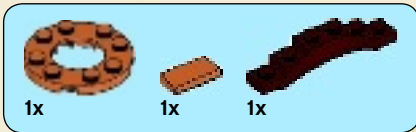

77

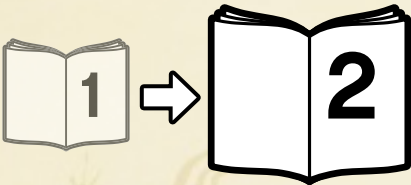
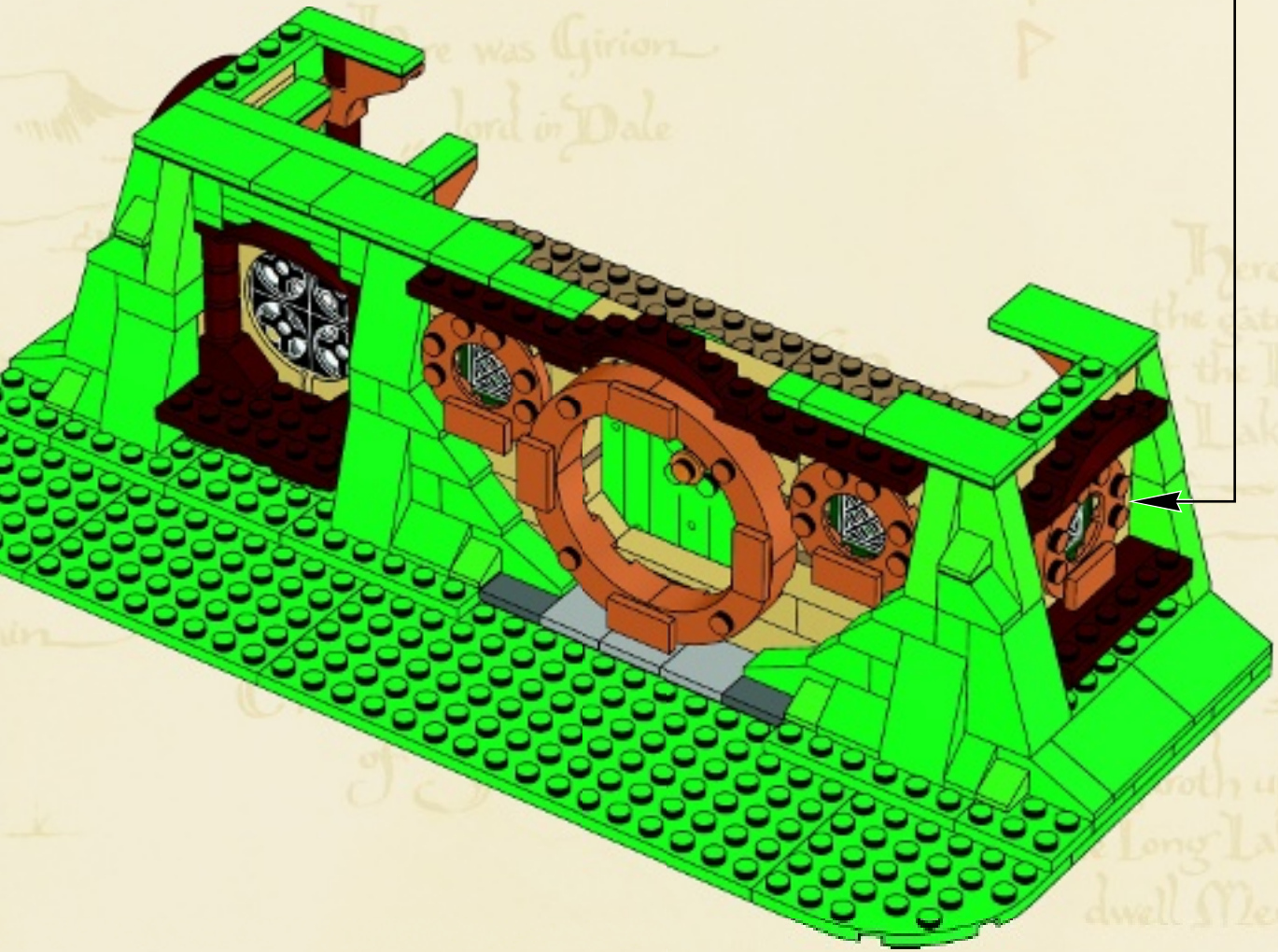



# WIN!

Go to [www.LEGOsurvey.com/product](http://www.LEGOsurvey.com/product) to fill out a survey for a chance to win a cool LEGO® Product.

No purchase necessary.

Open to all residents where not prohibited.



## [www.LEGOsurvey.com/product](http://www.LEGOsurvey.com/product)

### GEWINNE!

Nimm an der Umfrage auf [www.LEGOsurvey.com/product](http://www.LEGOsurvey.com/product) teil und hab die Chance ein cooles LEGO® Produkt zu gewinnen!

Die Teilnahme am Gewinnspiel führt zu keinerlei Kaufverpflichtungen. Teilnahme in allen nicht ausgeschlossenen Ländern möglich.

### WIN!

Ga naar [www.LEGOsurvey.com/product](http://www.LEGOsurvey.com/product), vul een enquêteformulier in en maak kans op een cool LEGO® product.

Geen aankoopverplichting. Iedereen mag deelnemen, uitgezonderd ingezetenden van landen waar een enquêteverbod geldt.

### GAGNE!

Visite [www.LEGOsurvey.com/product](http://www.LEGOsurvey.com/product) pour répondre à un questionnaire et avoir une chance de gagner un produit LEGO® très cool!

Aucune obligation d'achat. Ouvert à tous les résidents des pays autorisés.

### 当てよう!

[www.LEGOsurvey.com/product](http://www.LEGOsurvey.com/product) にアクセスして、アンケートにご記入ください。当選者にはレゴ製品を差し上げます。

お買い上げの必要はありません。禁止されていない限り、すべての皆様にご利用いただけます。



LEGO.com

6036614

LEGO and the LEGO logo are trademarks of the LEGO Group. ©2012 The LEGO Group. THE HOBBIT: AN UNEXPECTED JOURNEY: © NLP™ Middle-earth Ent. Lic. to New Line. (s12)