

TECHNIC

LEGO

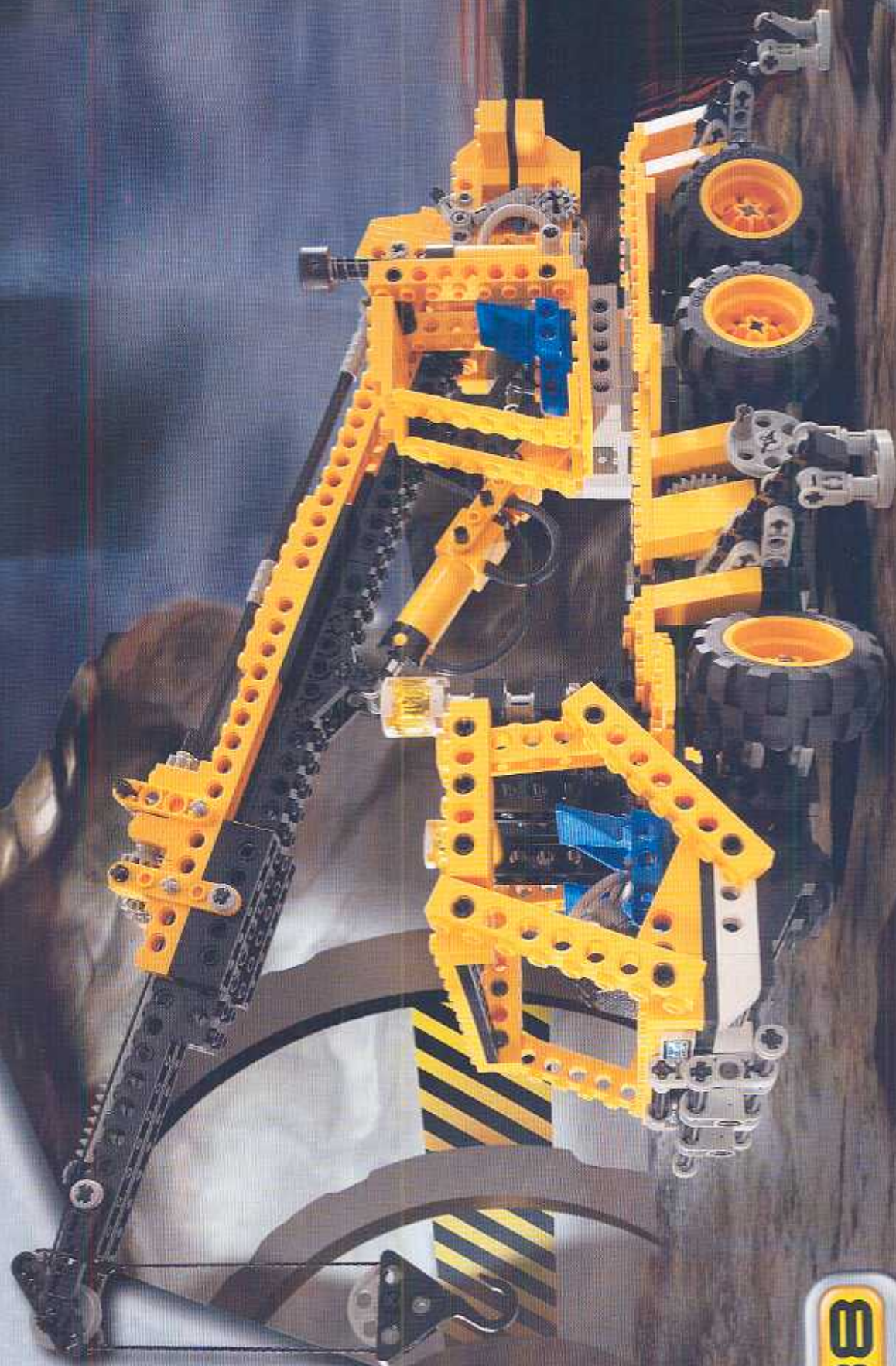

42110

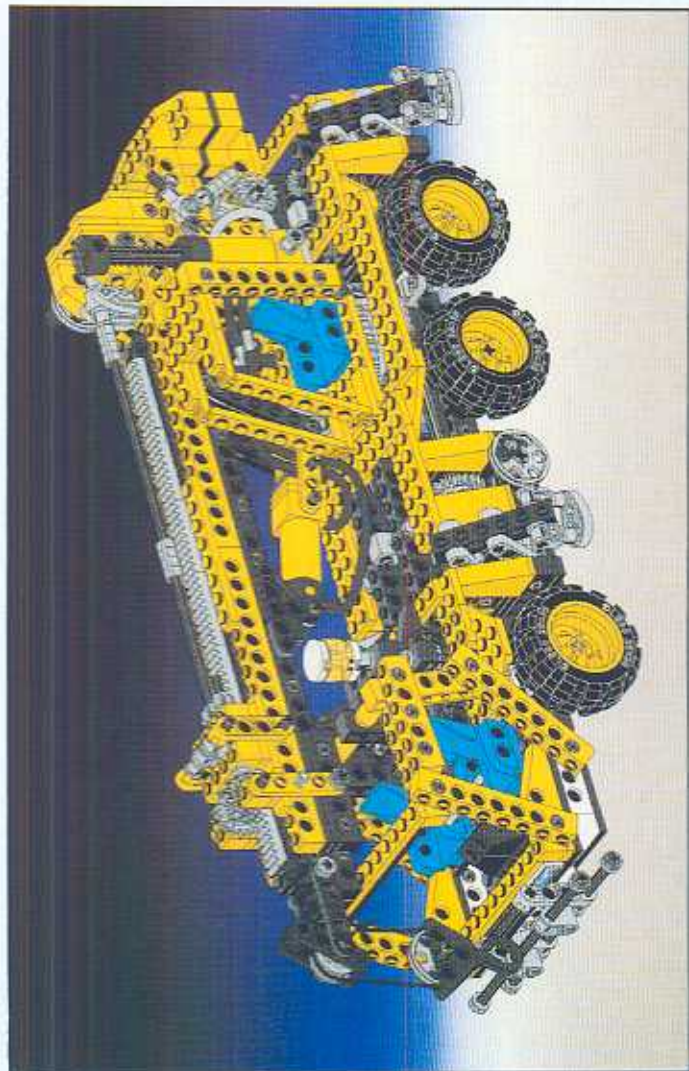

1

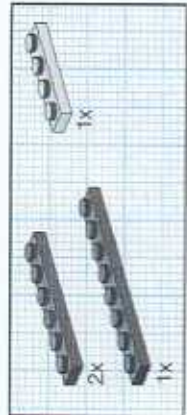

2

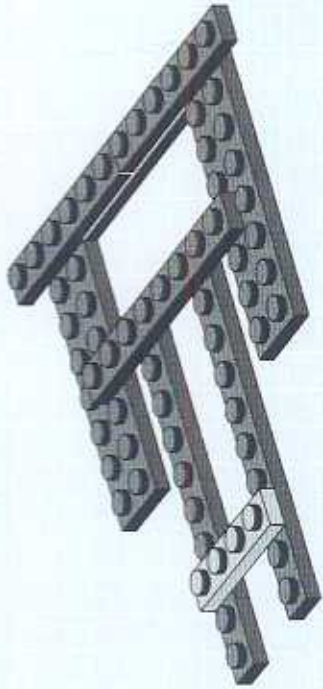

3

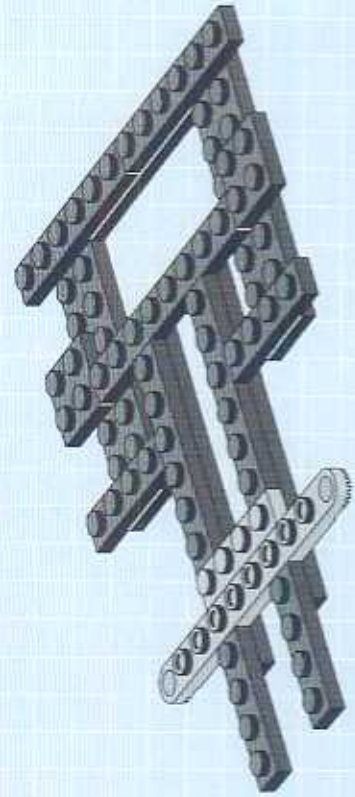

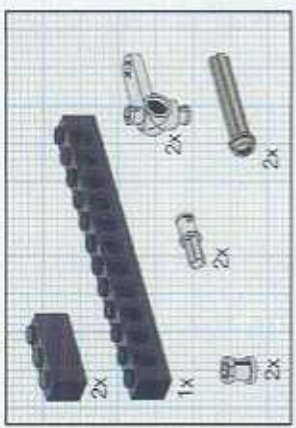

6

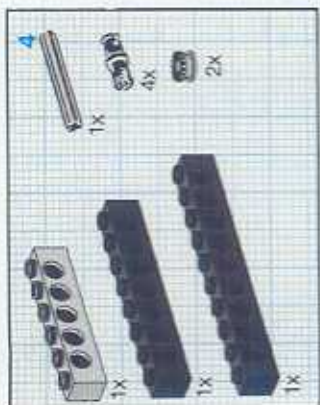
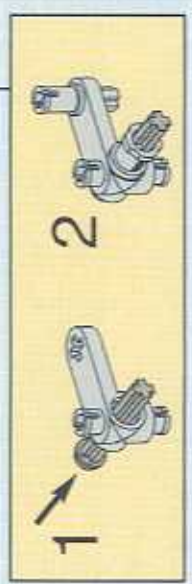
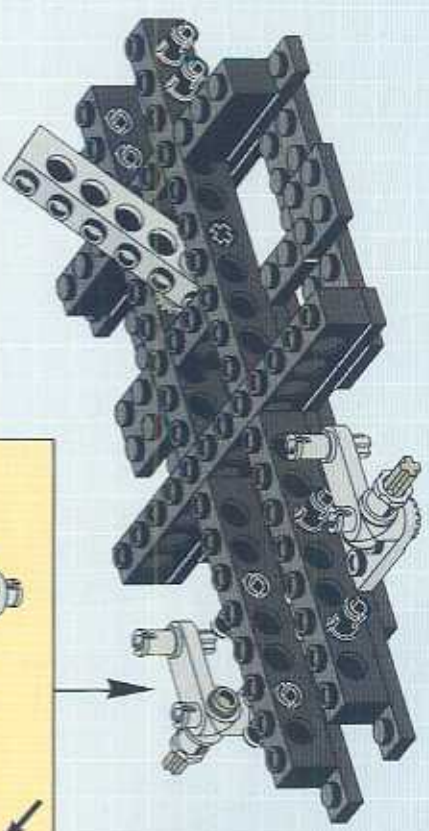
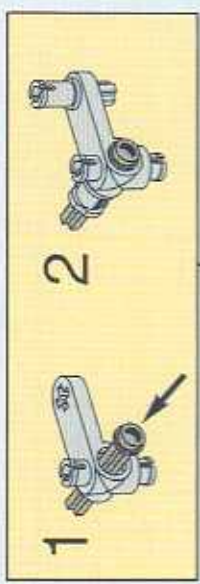

4

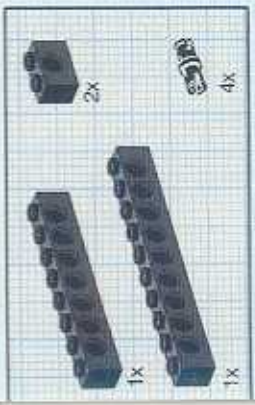
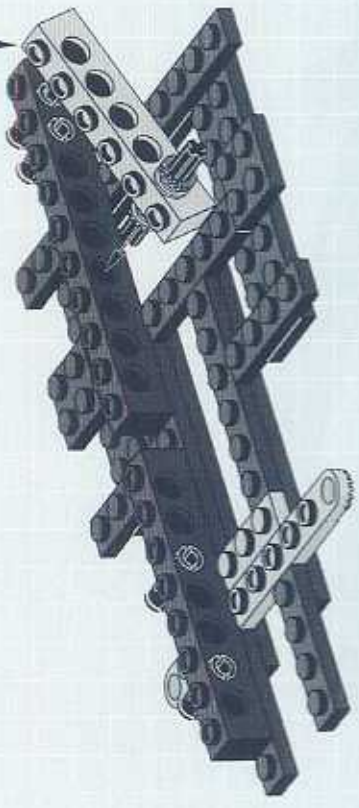

5

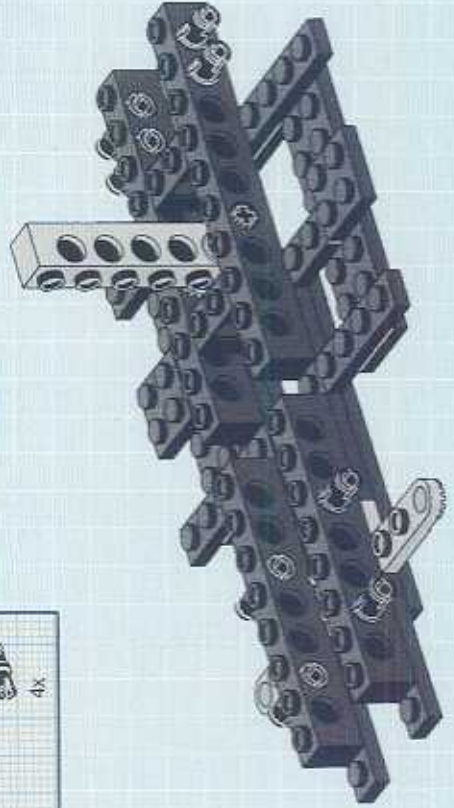

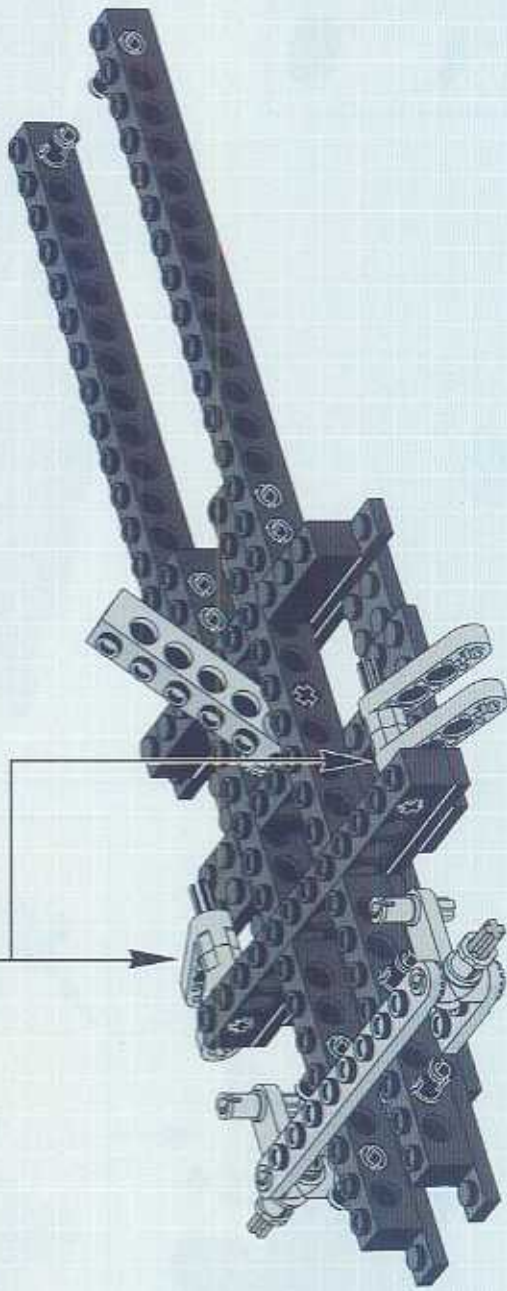

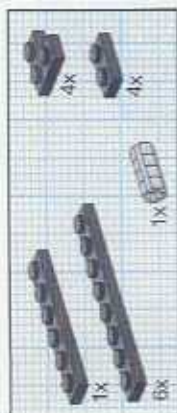
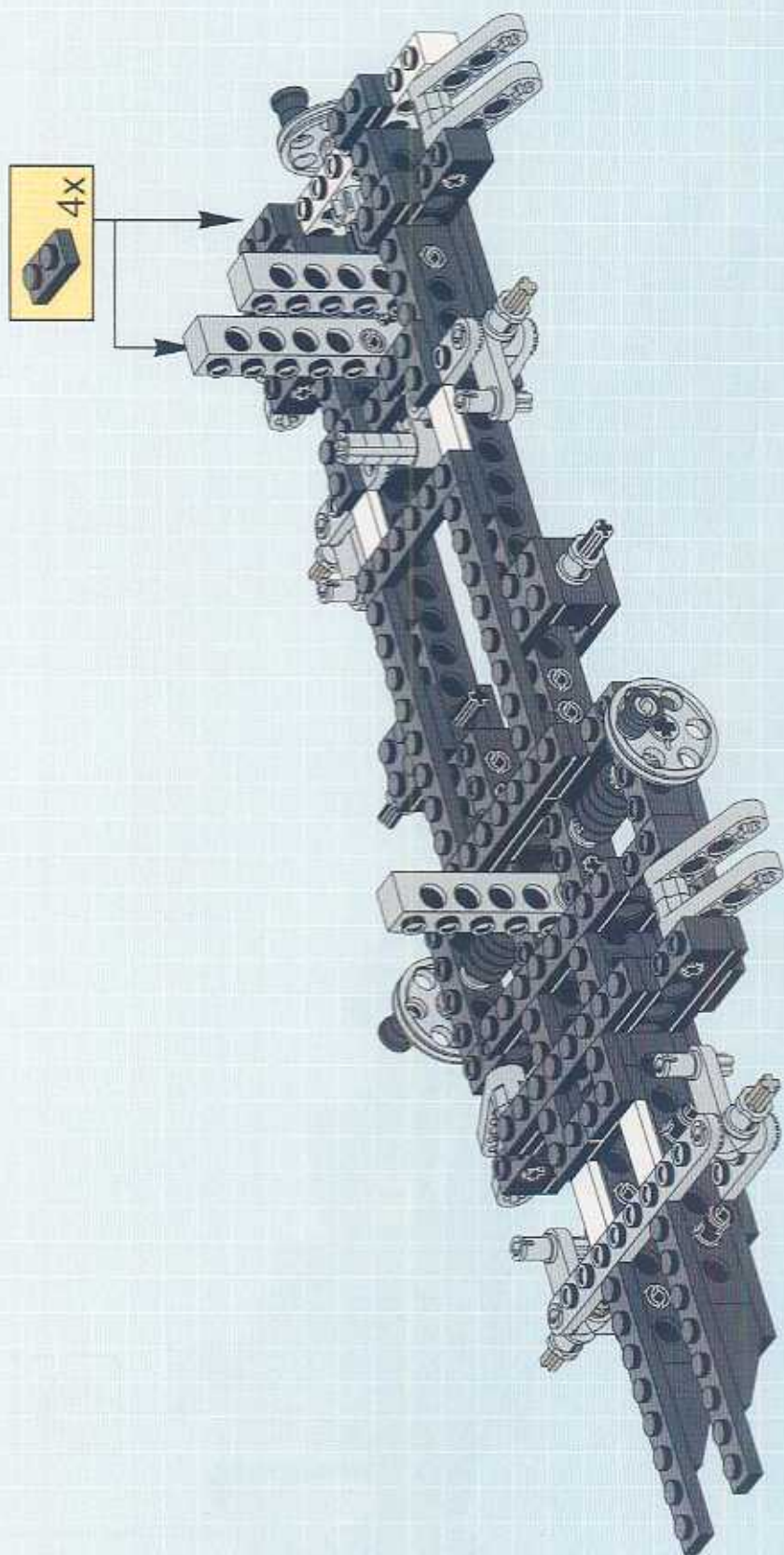

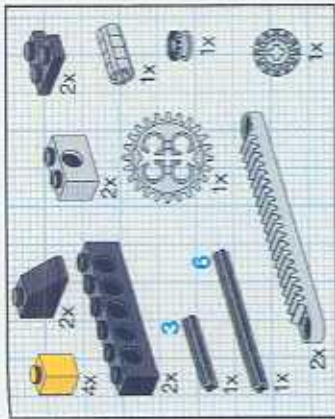

14

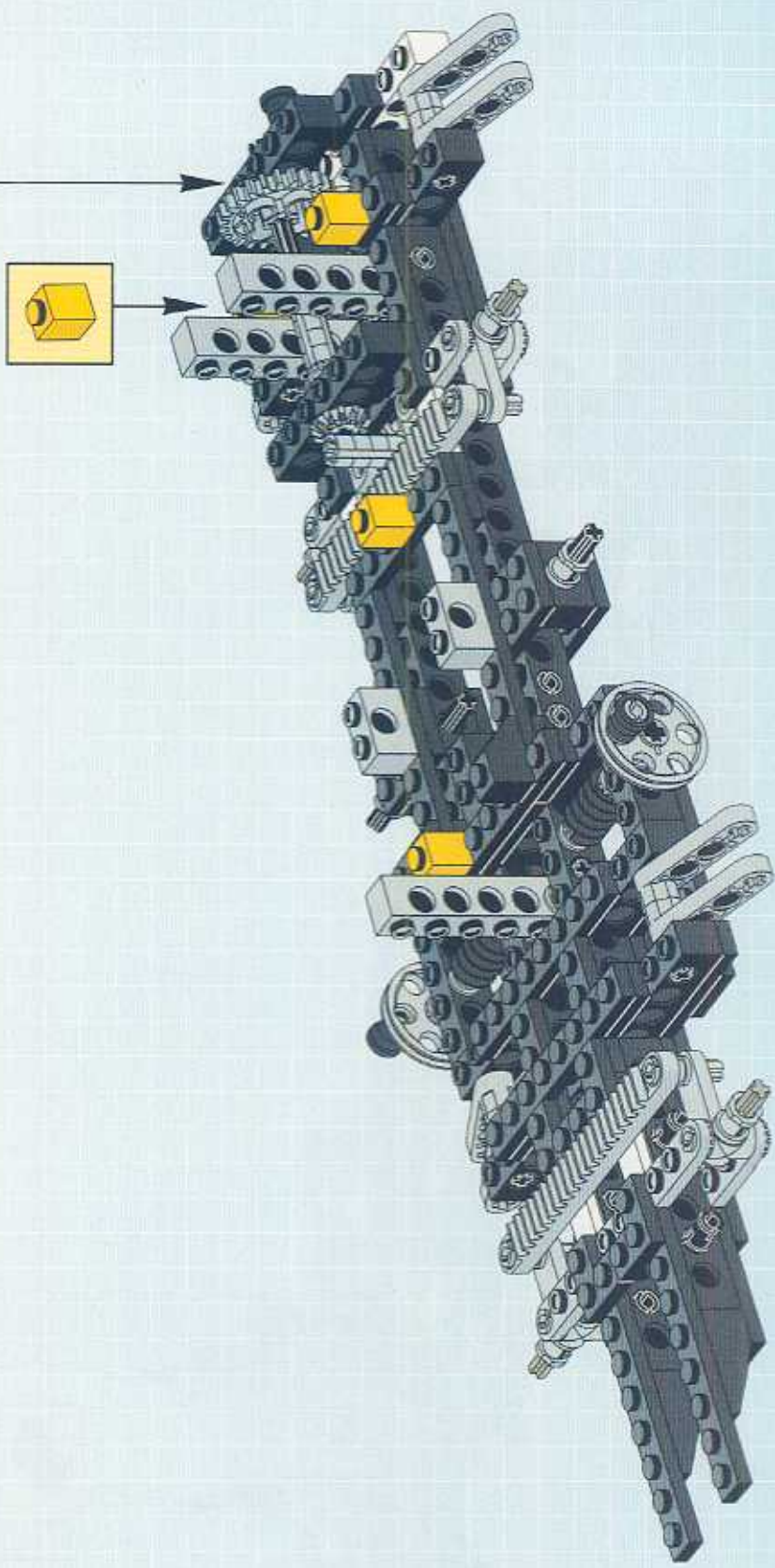

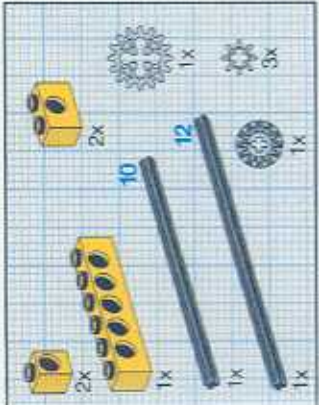
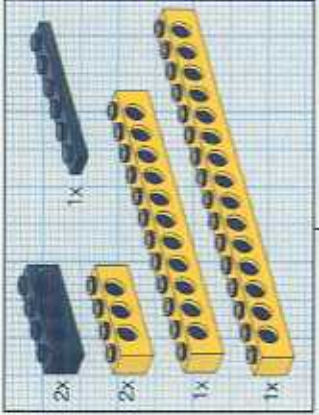
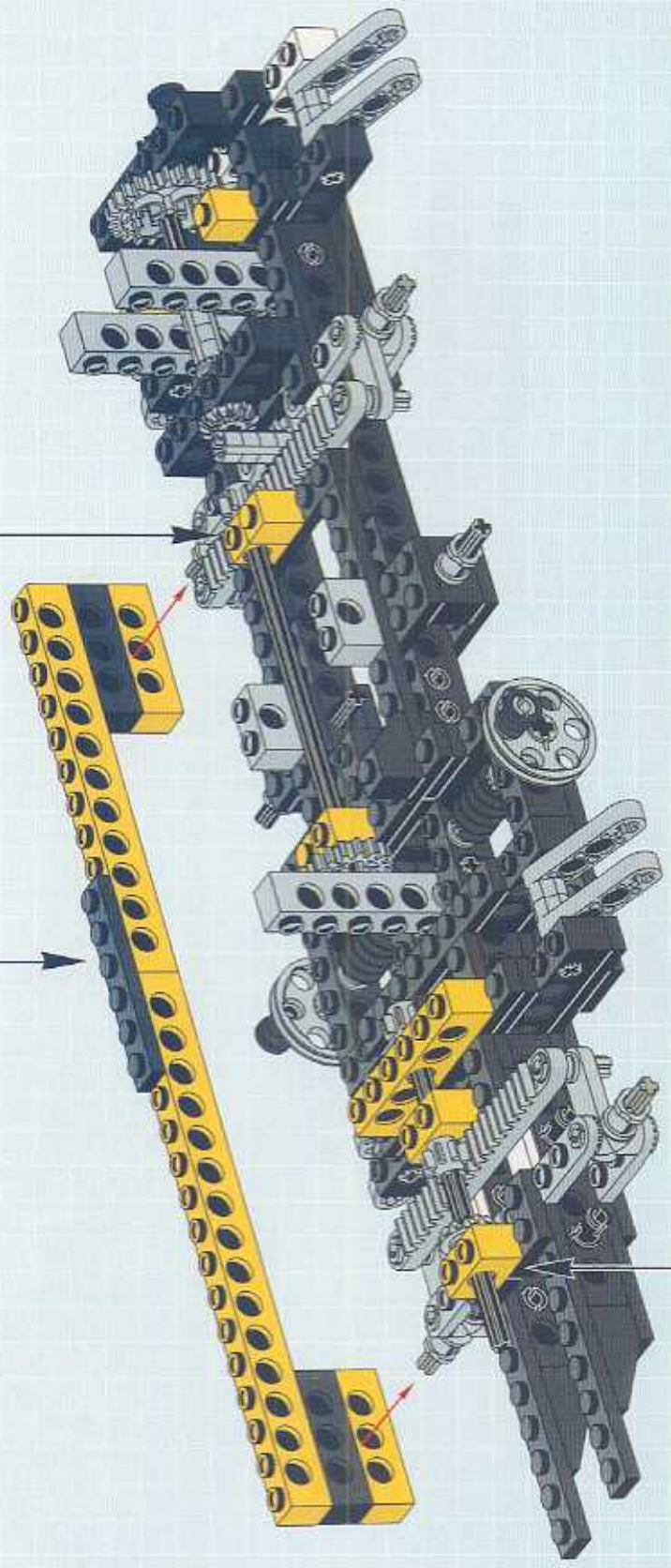

15

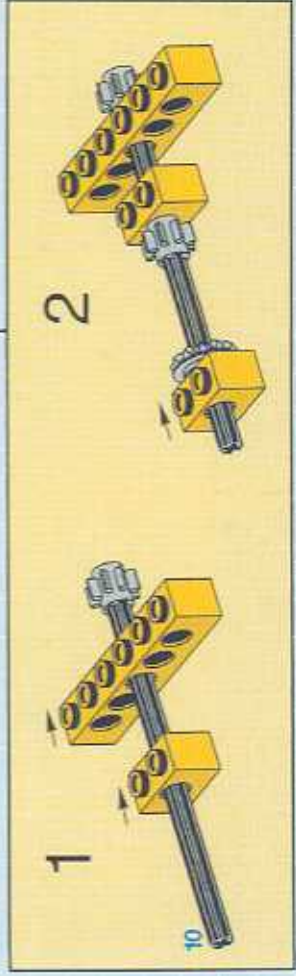



16

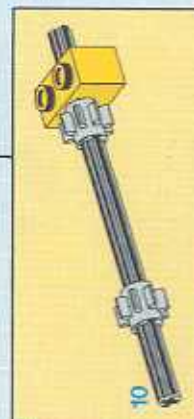
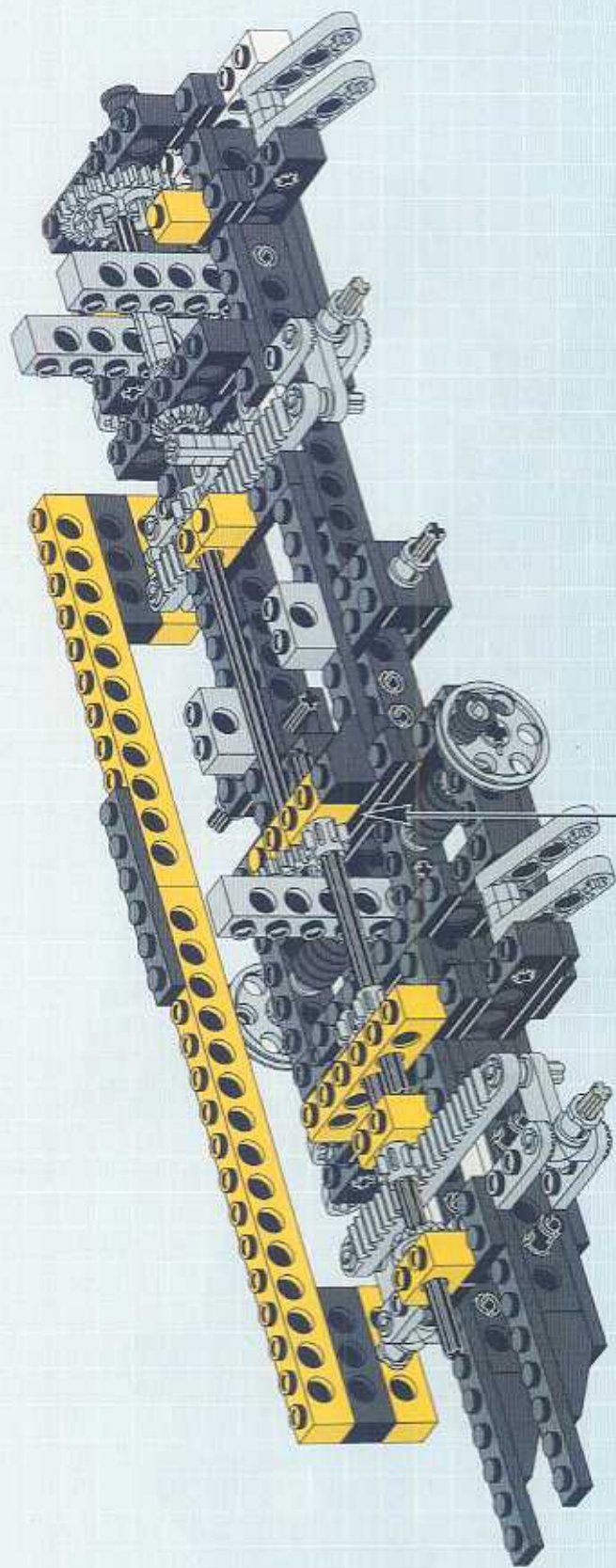

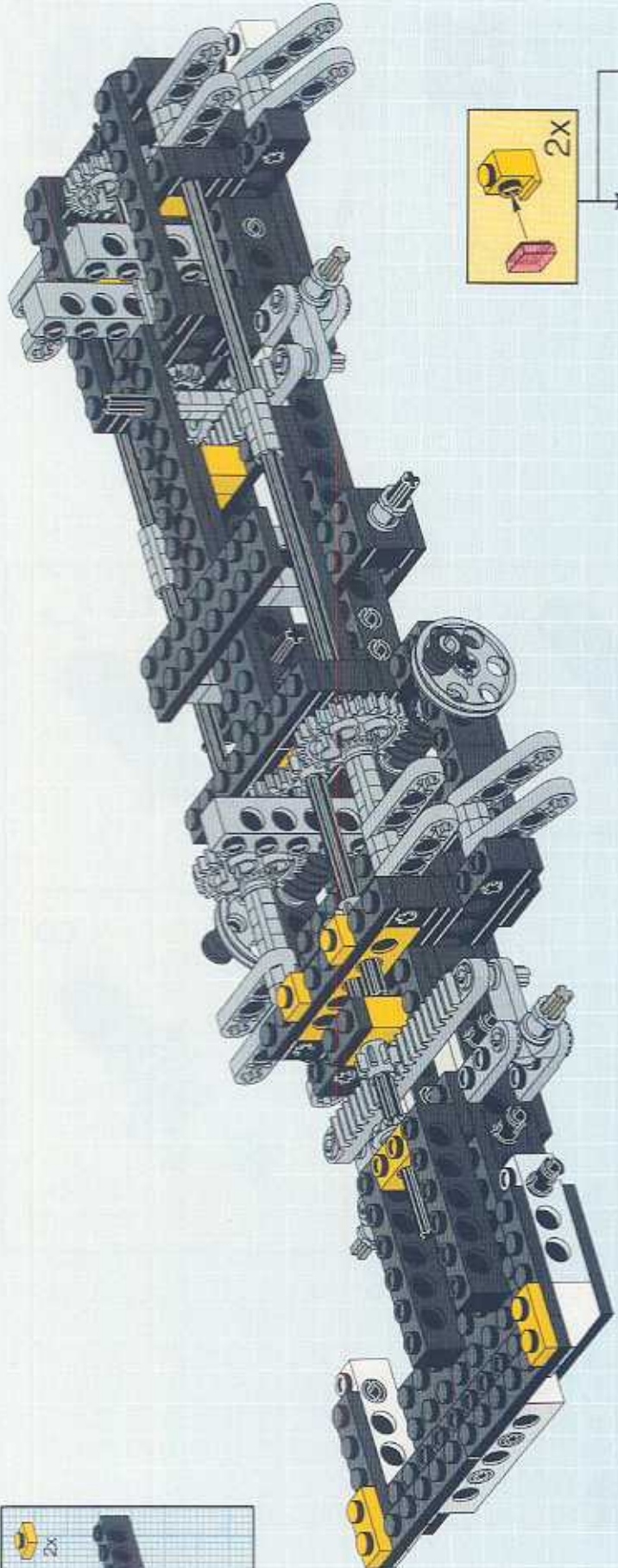

19

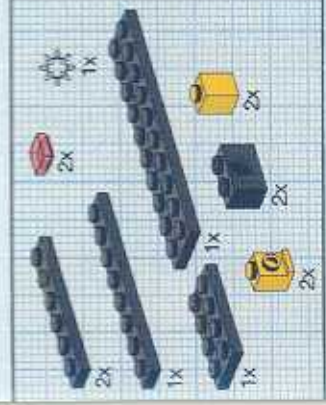
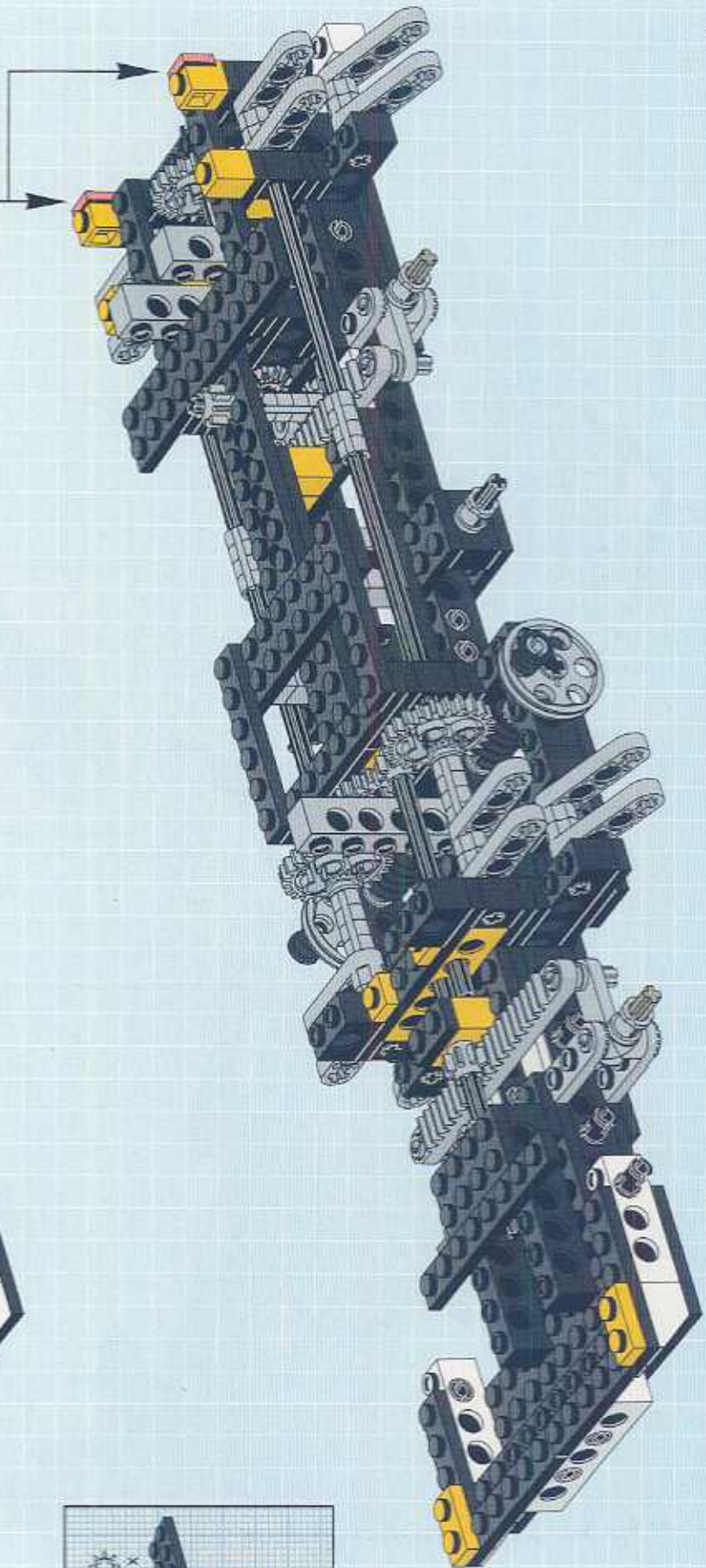
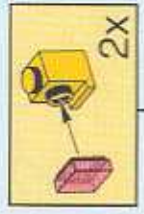

20

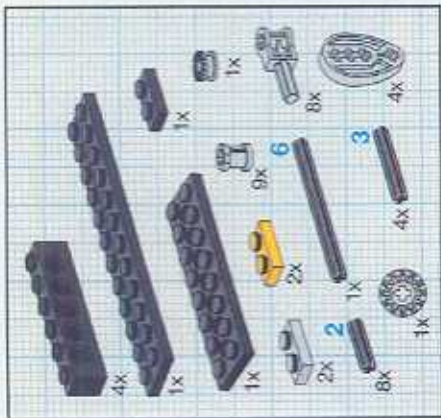

21

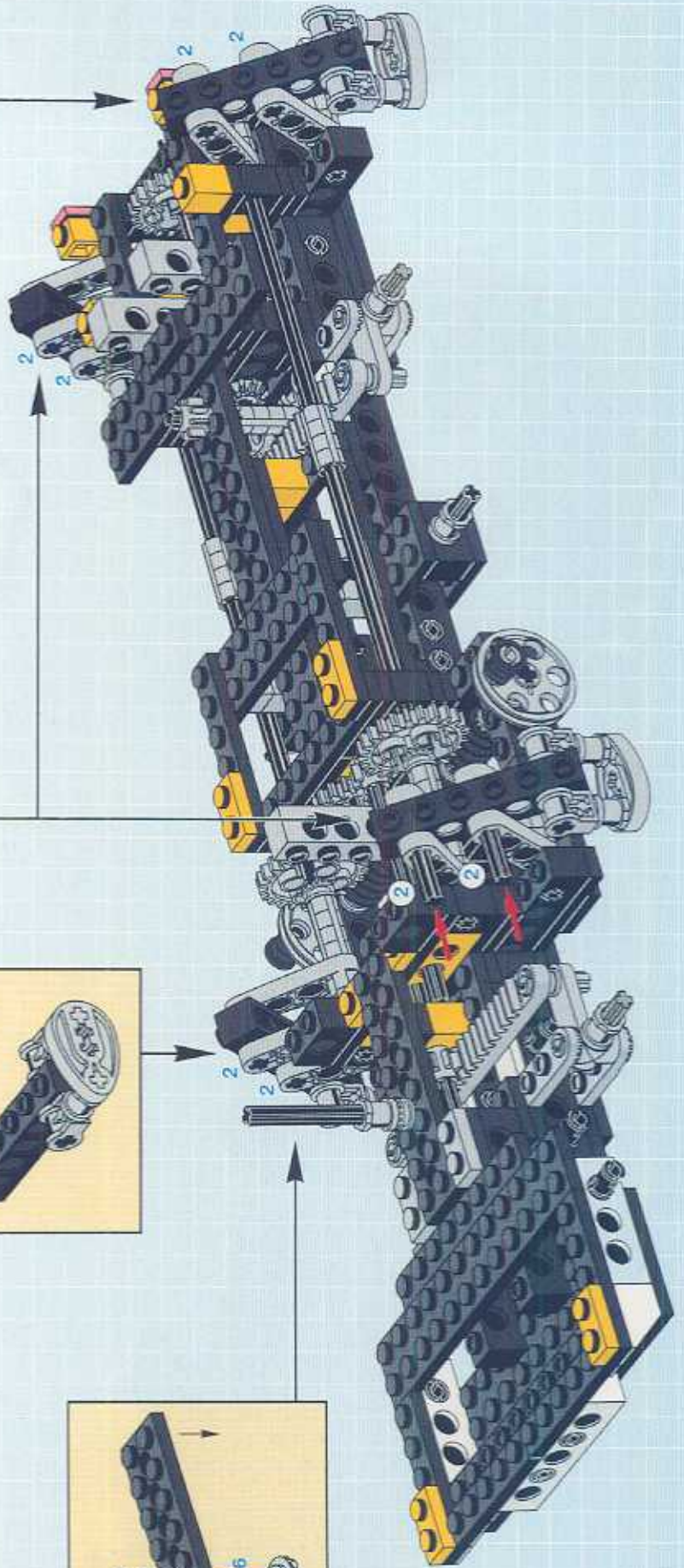
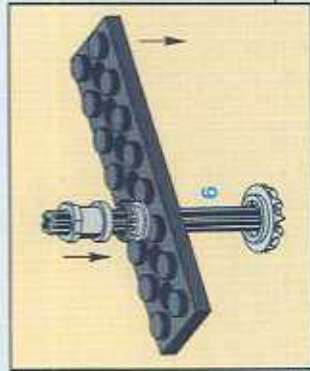
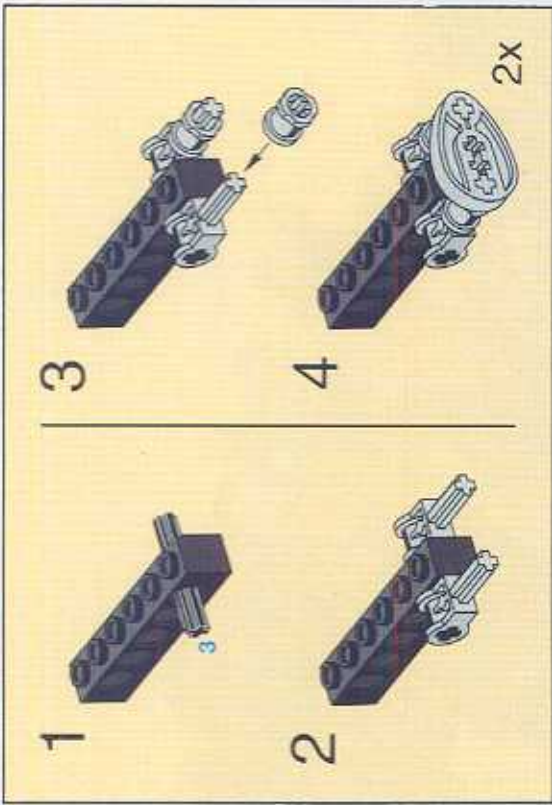

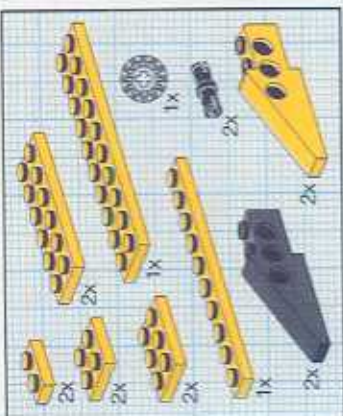
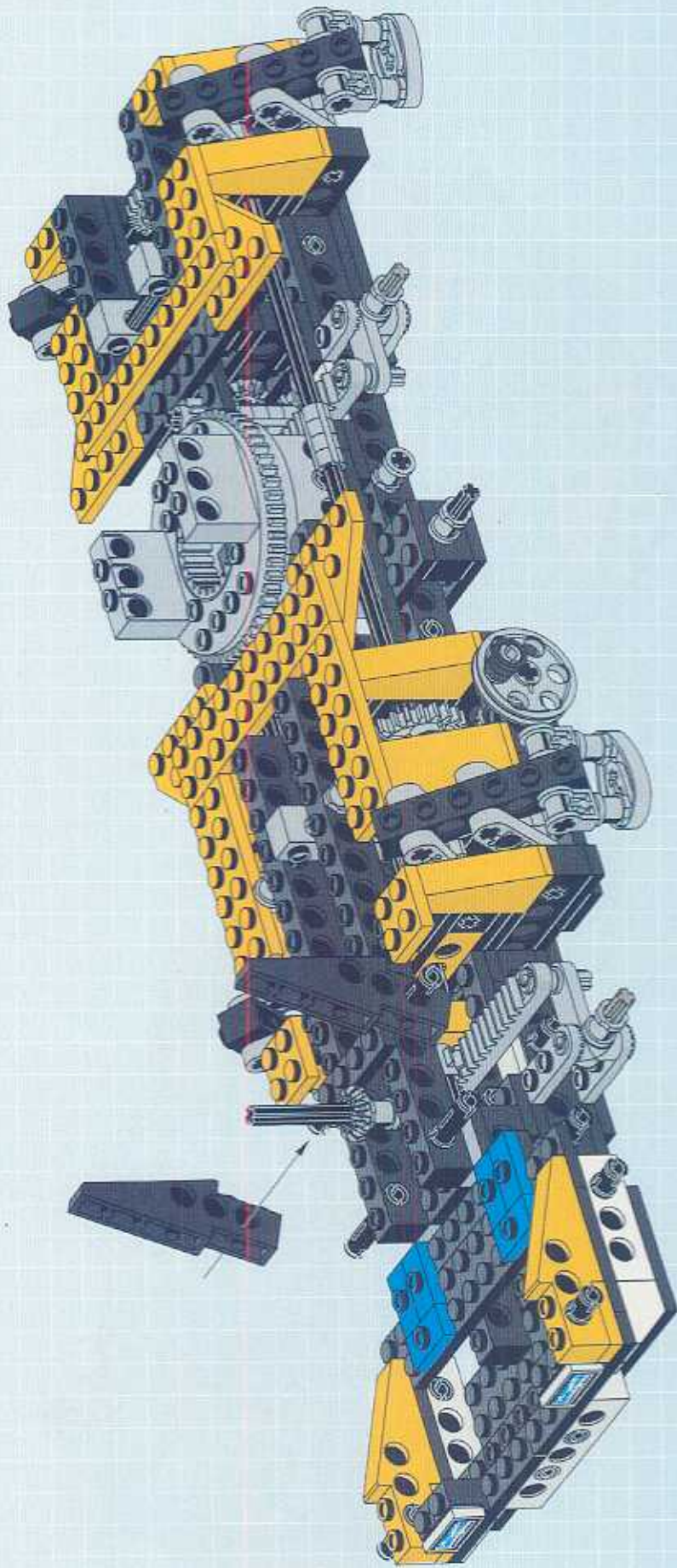

24



27

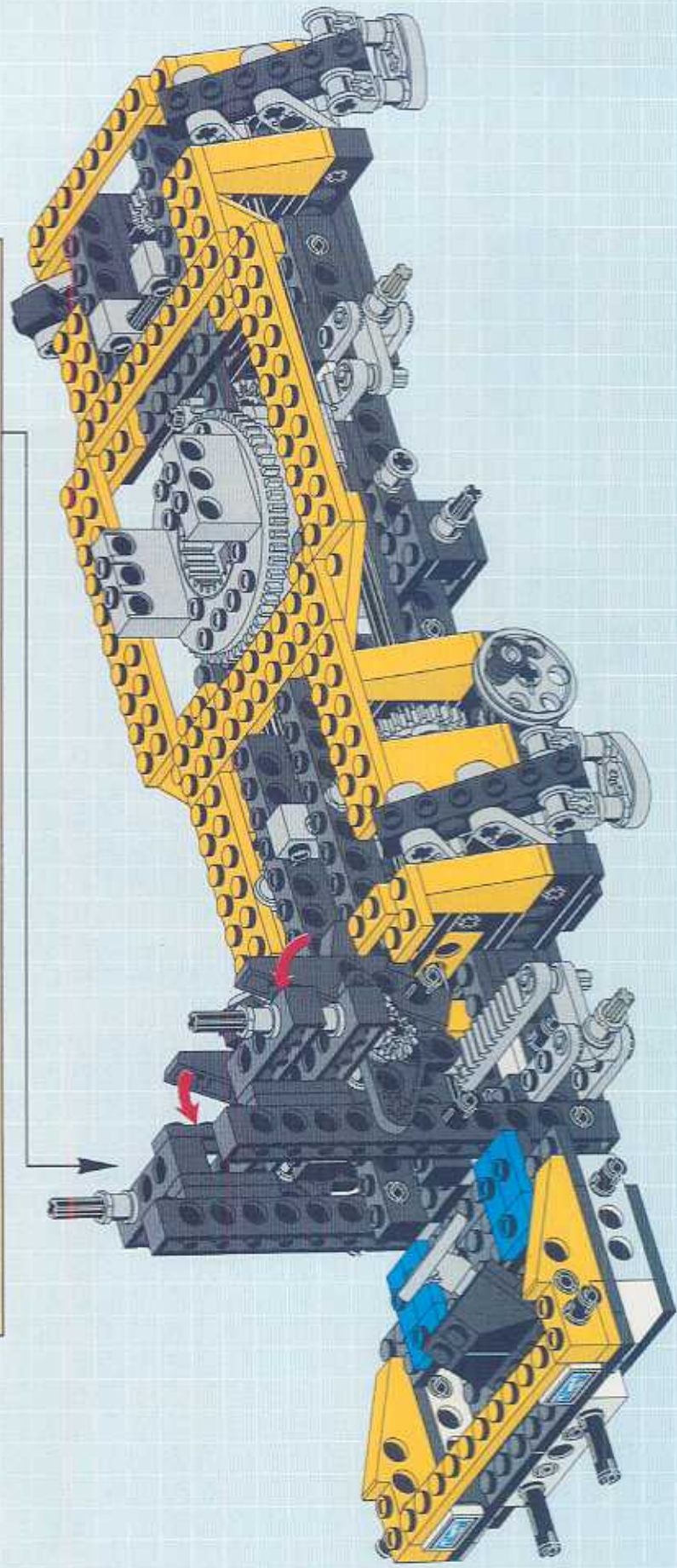
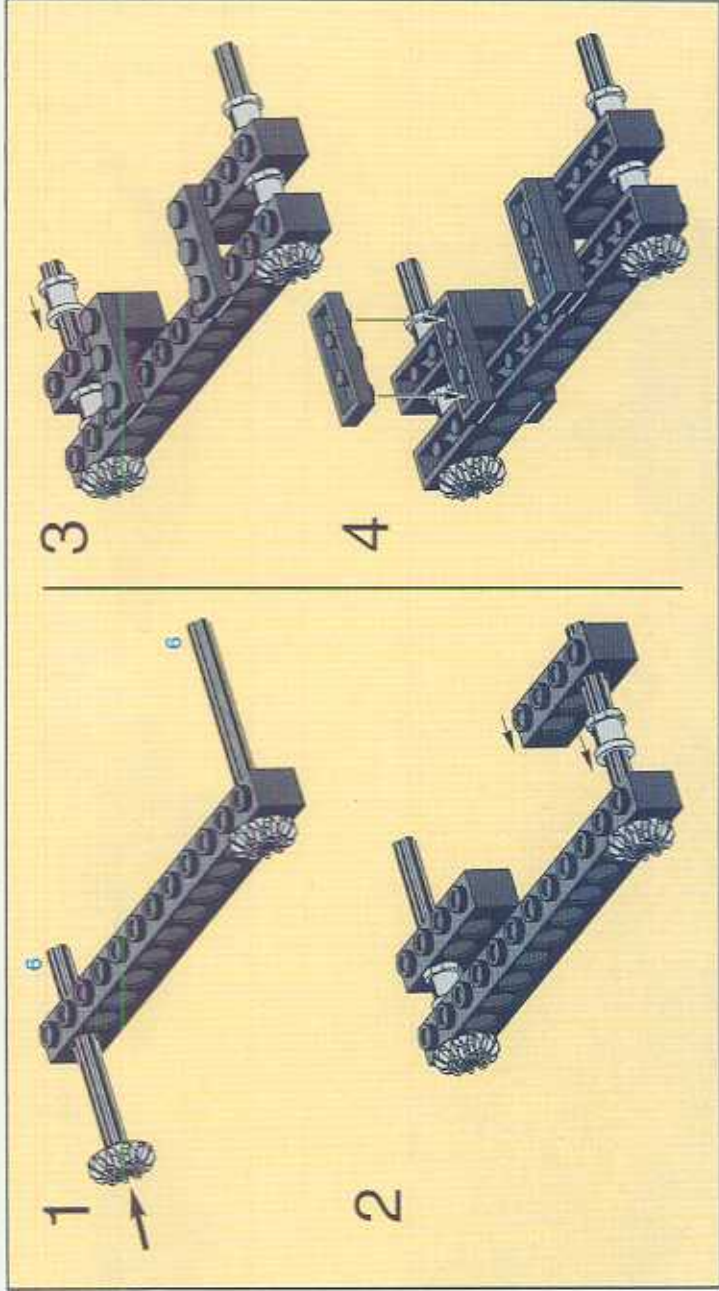

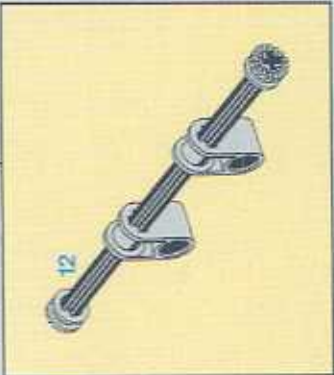
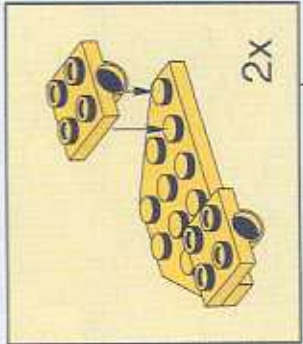
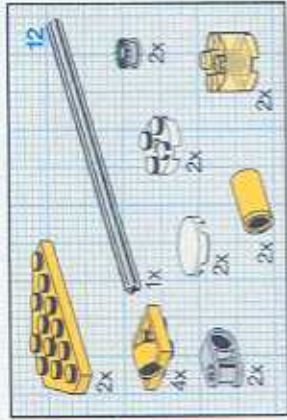
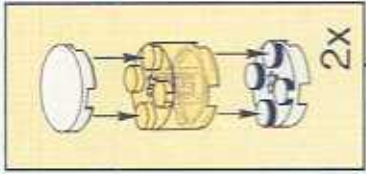
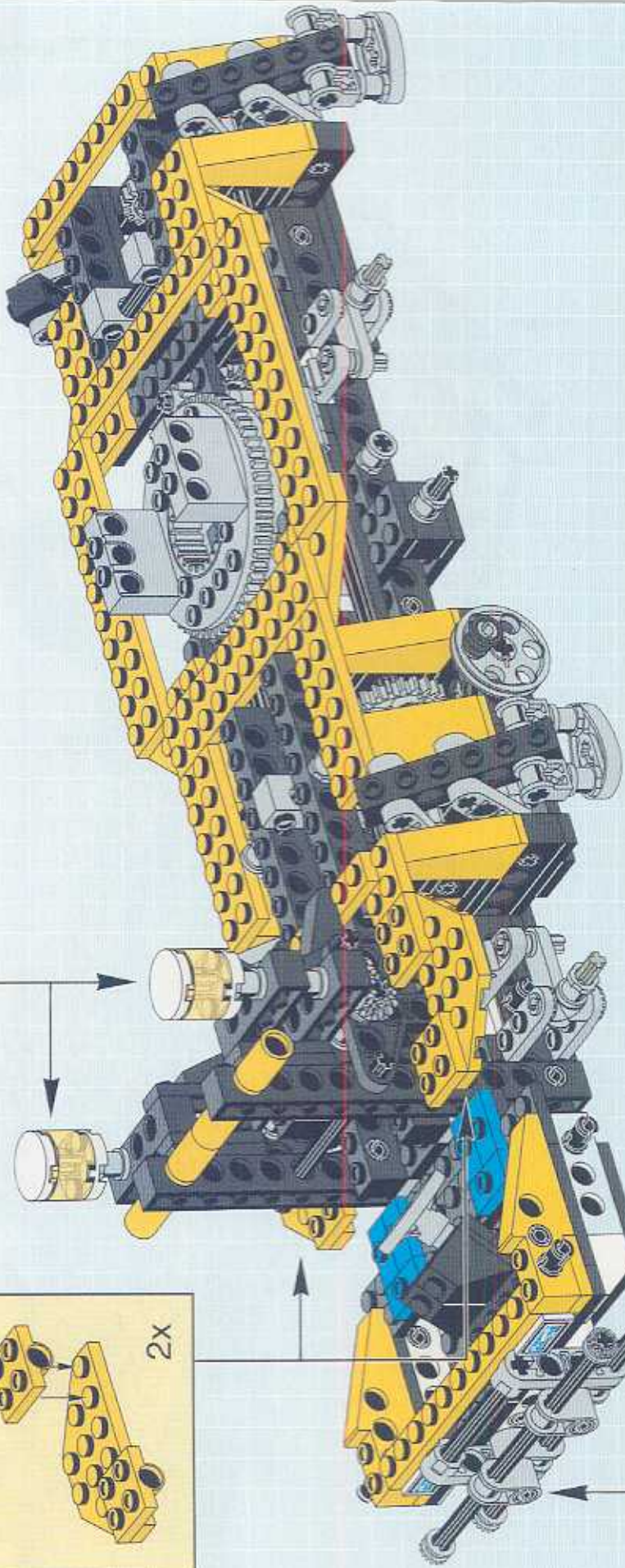

29



30

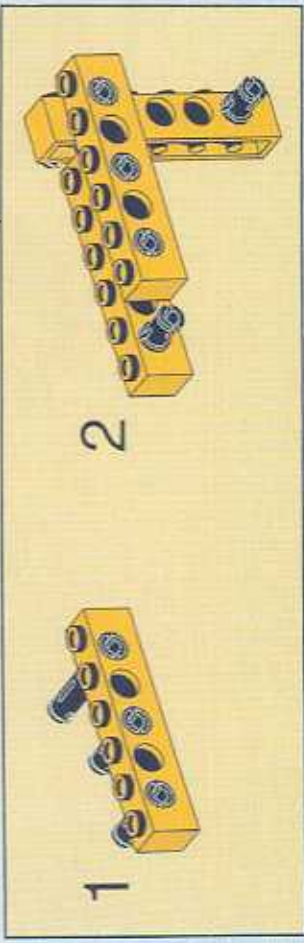
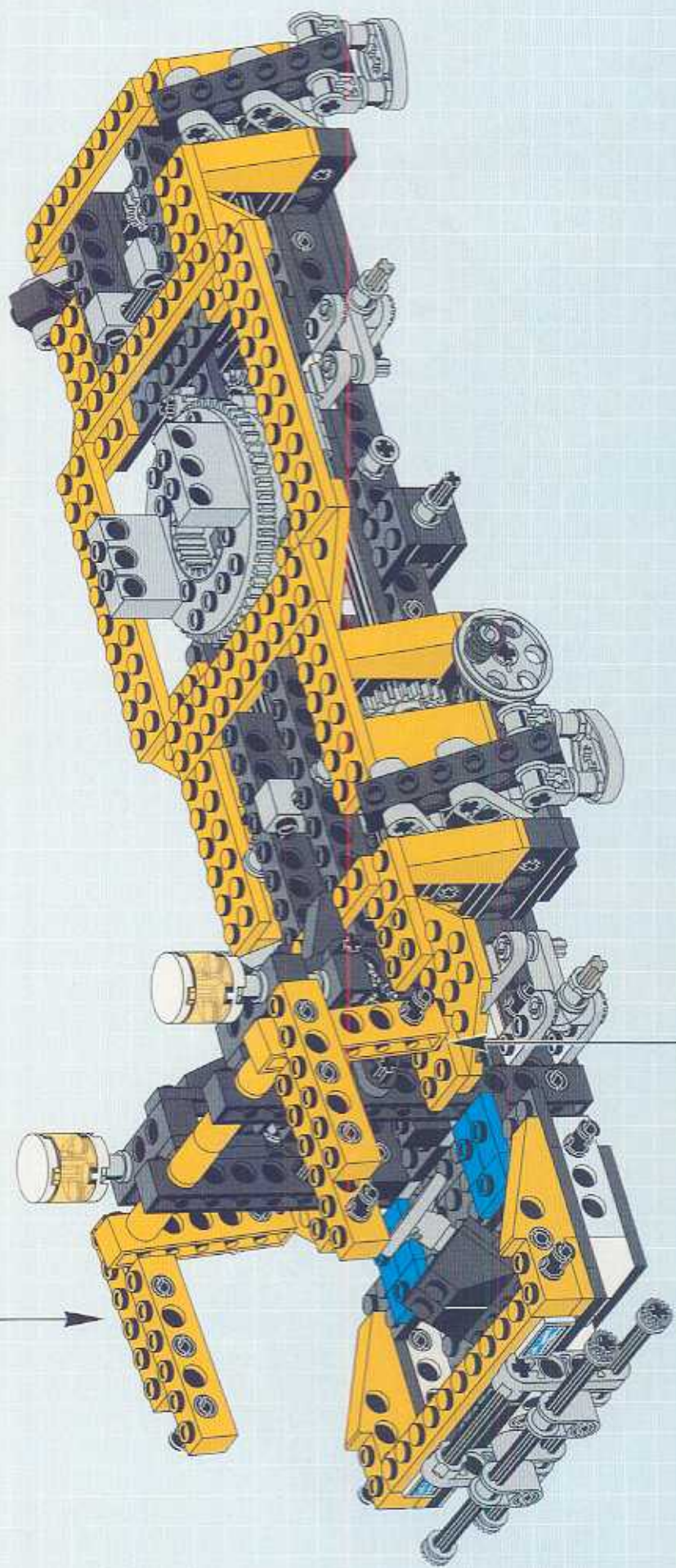
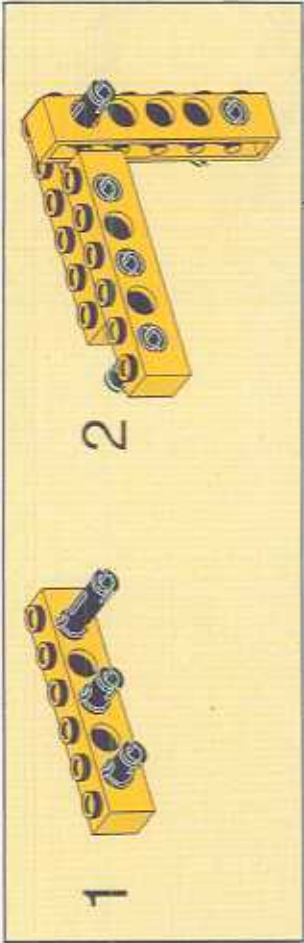

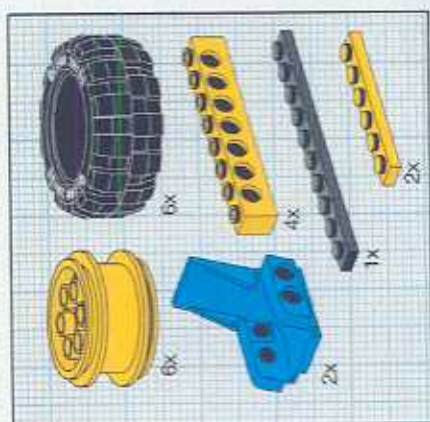
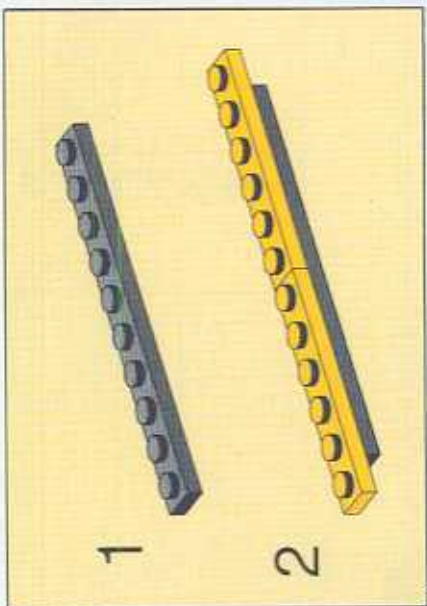
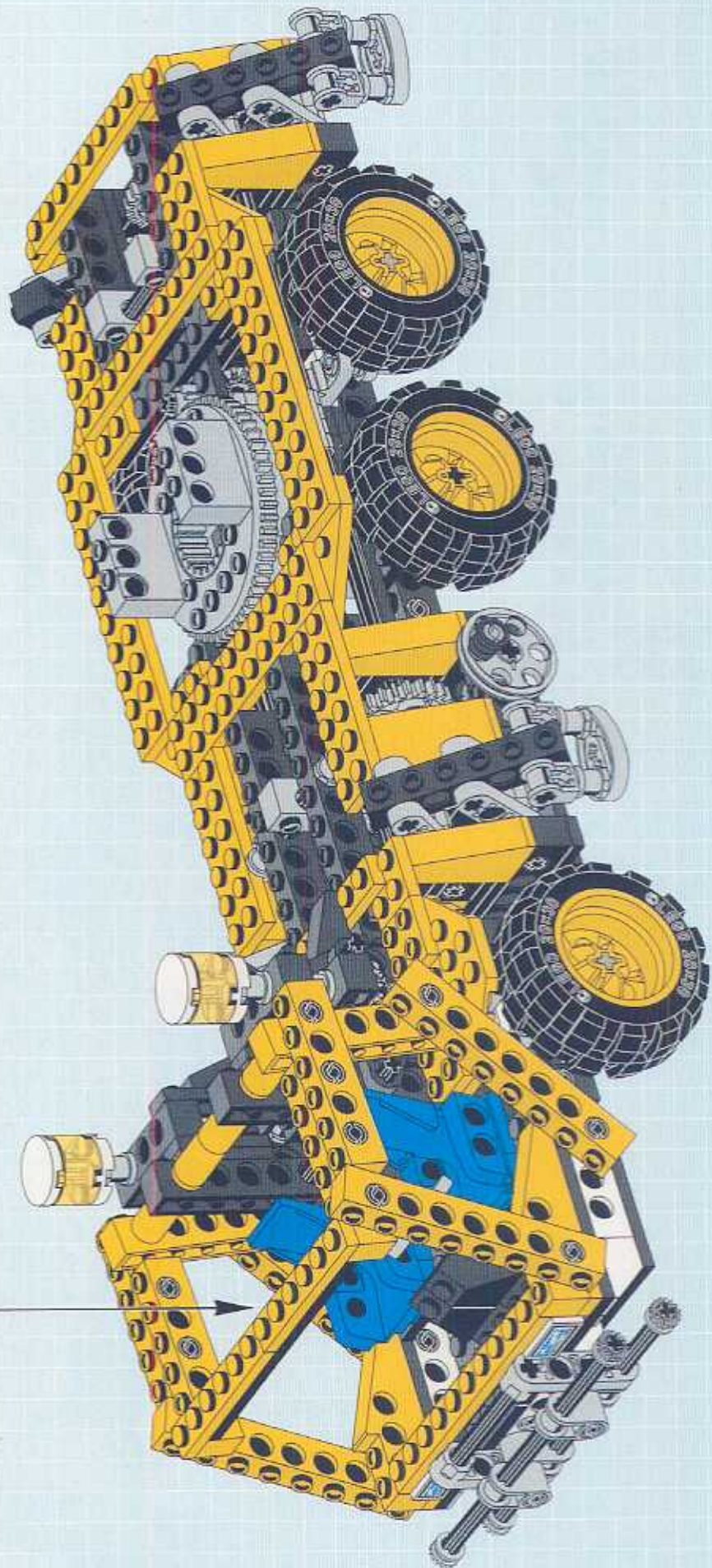

31

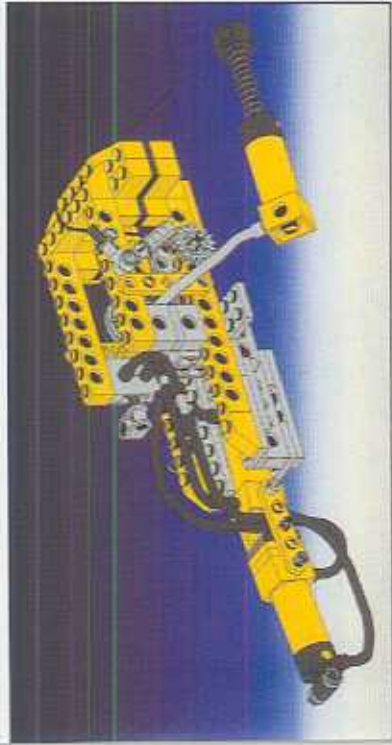

1



2

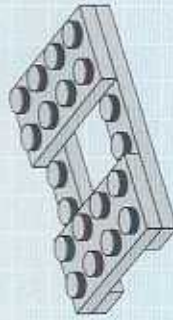

3

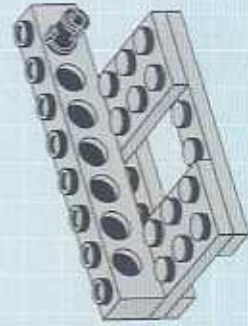

4

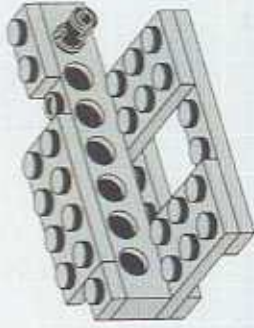

5

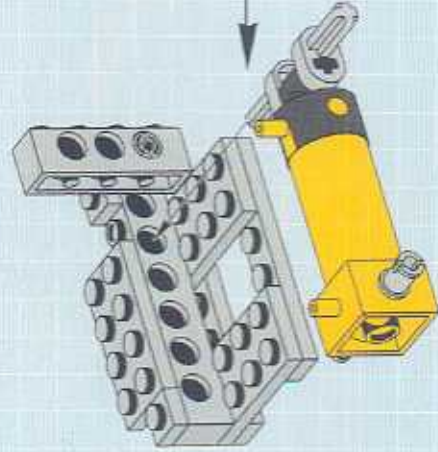
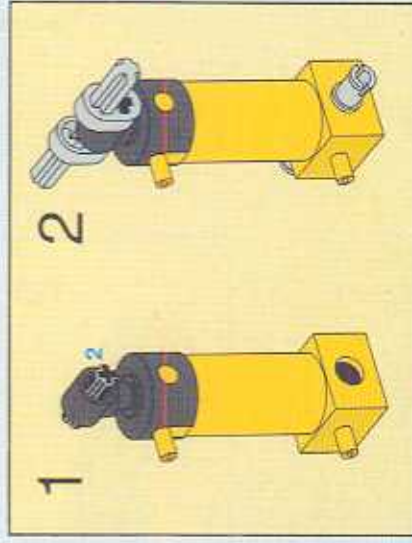



12

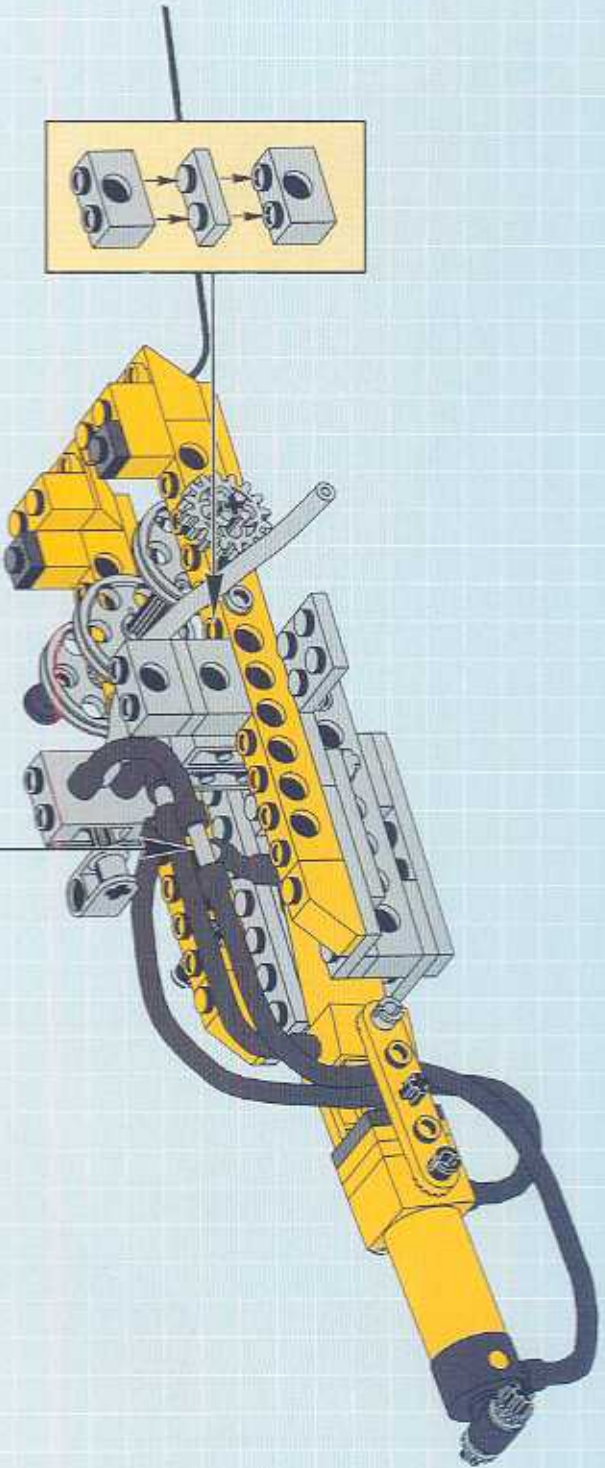
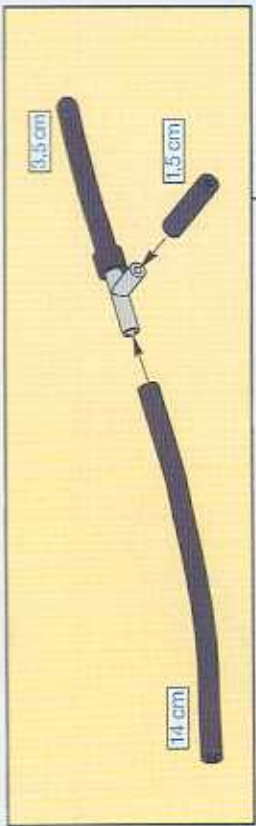

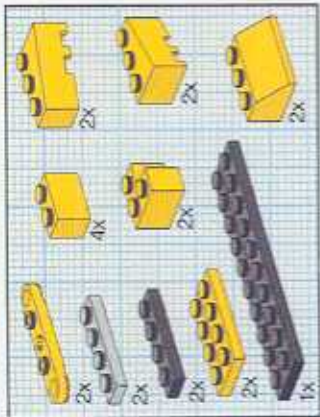

13

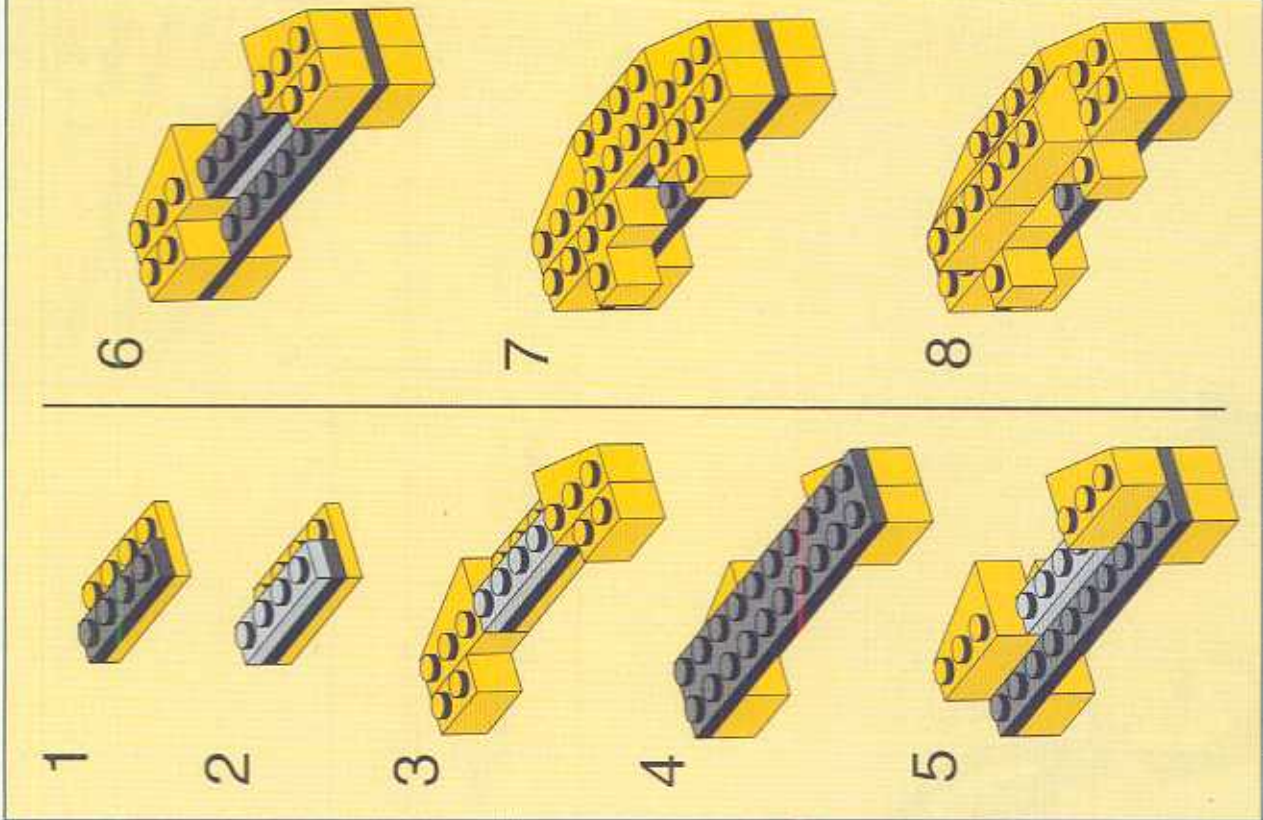
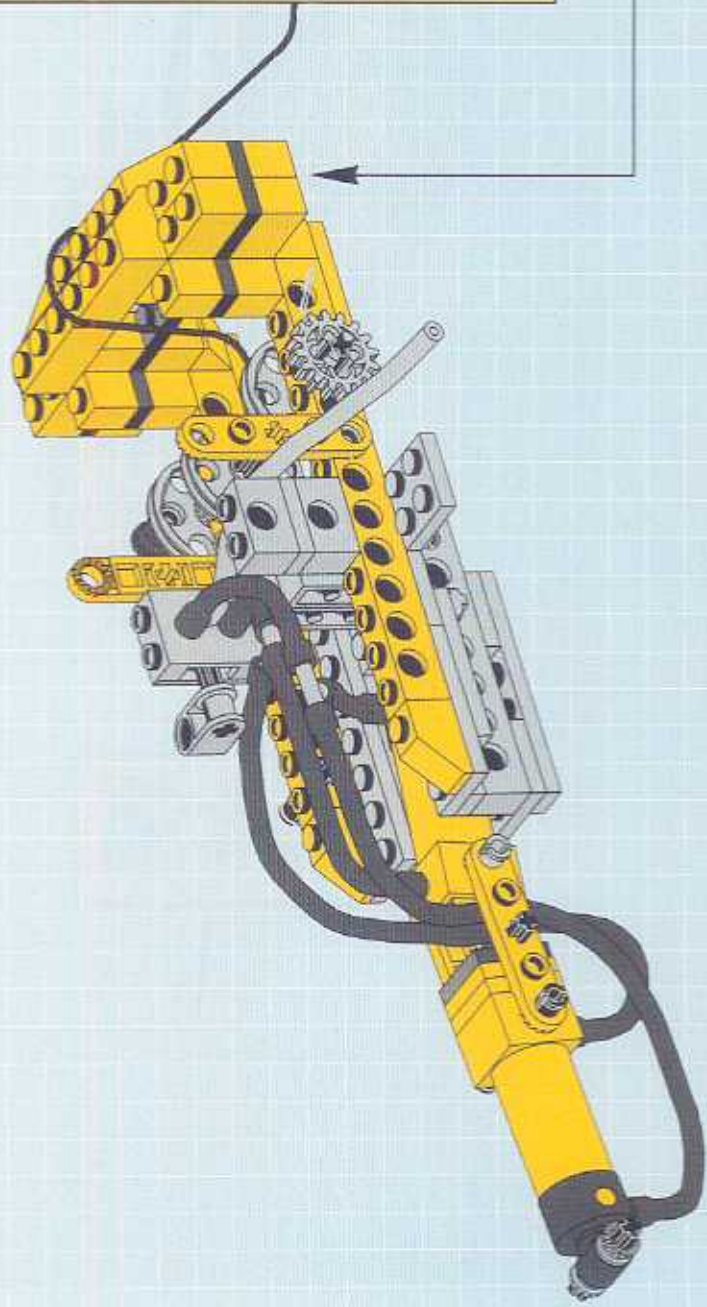

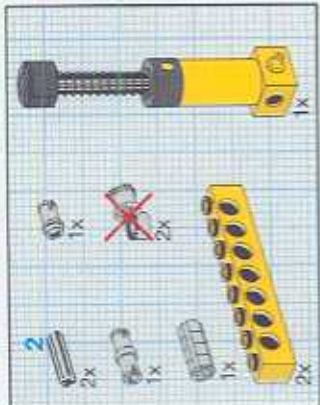
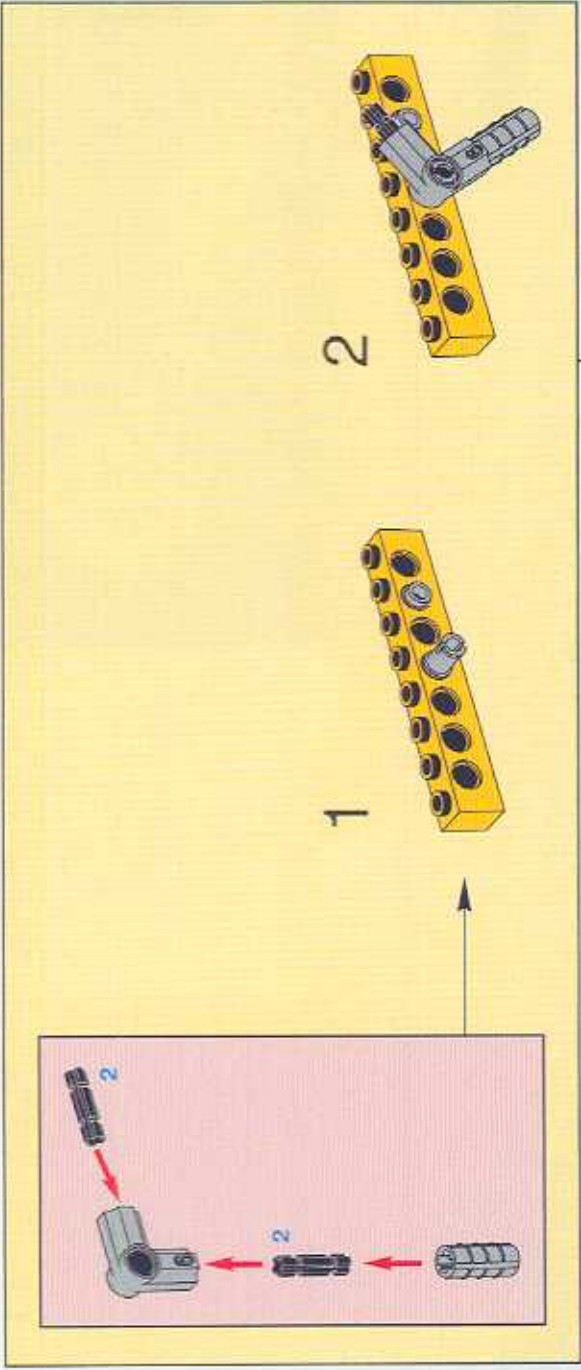
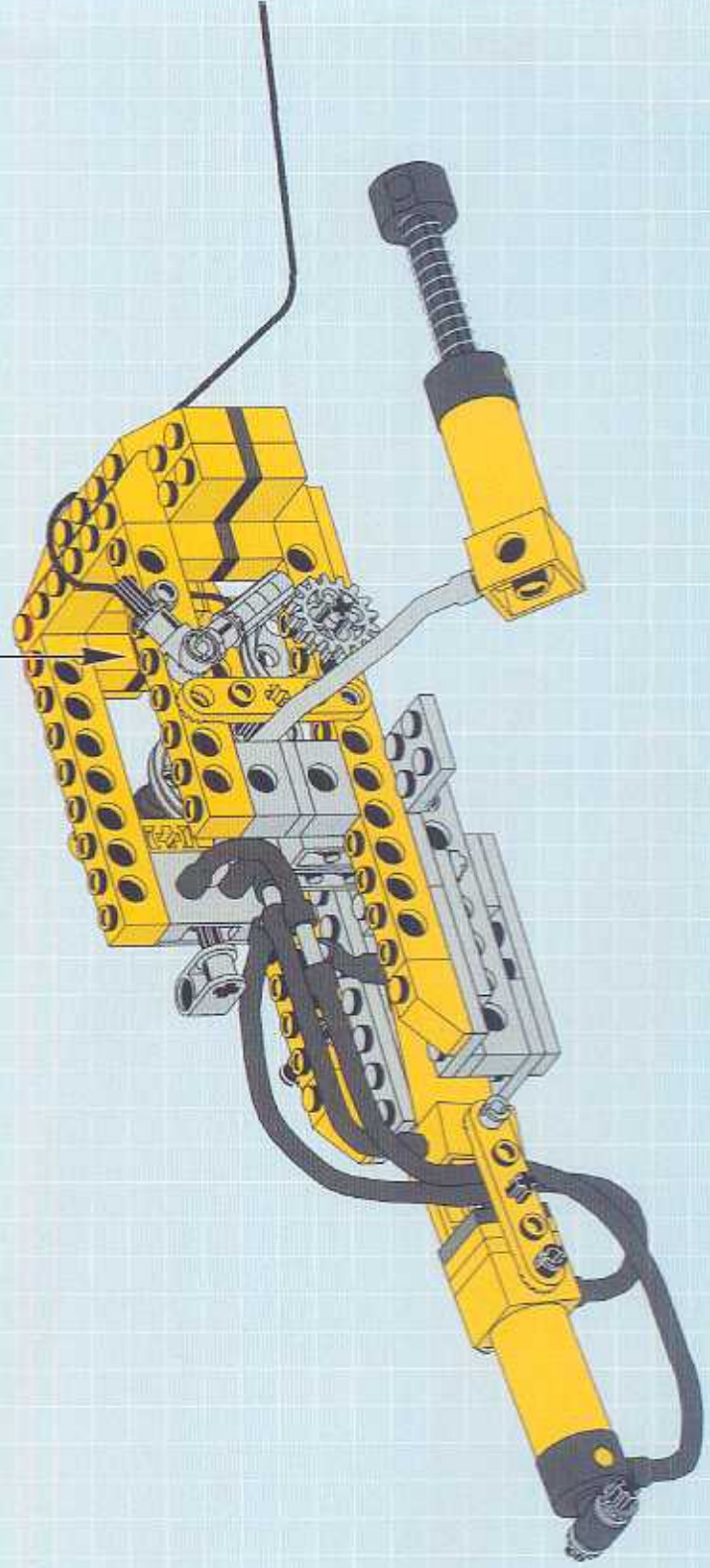

14

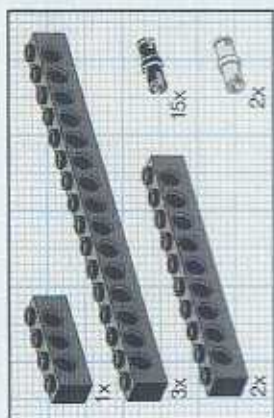

1



2

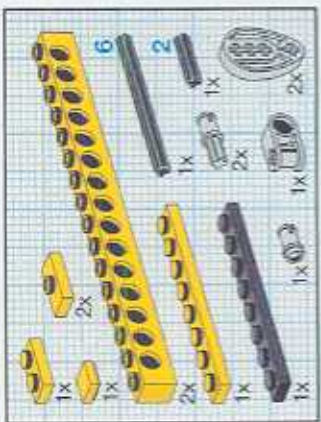
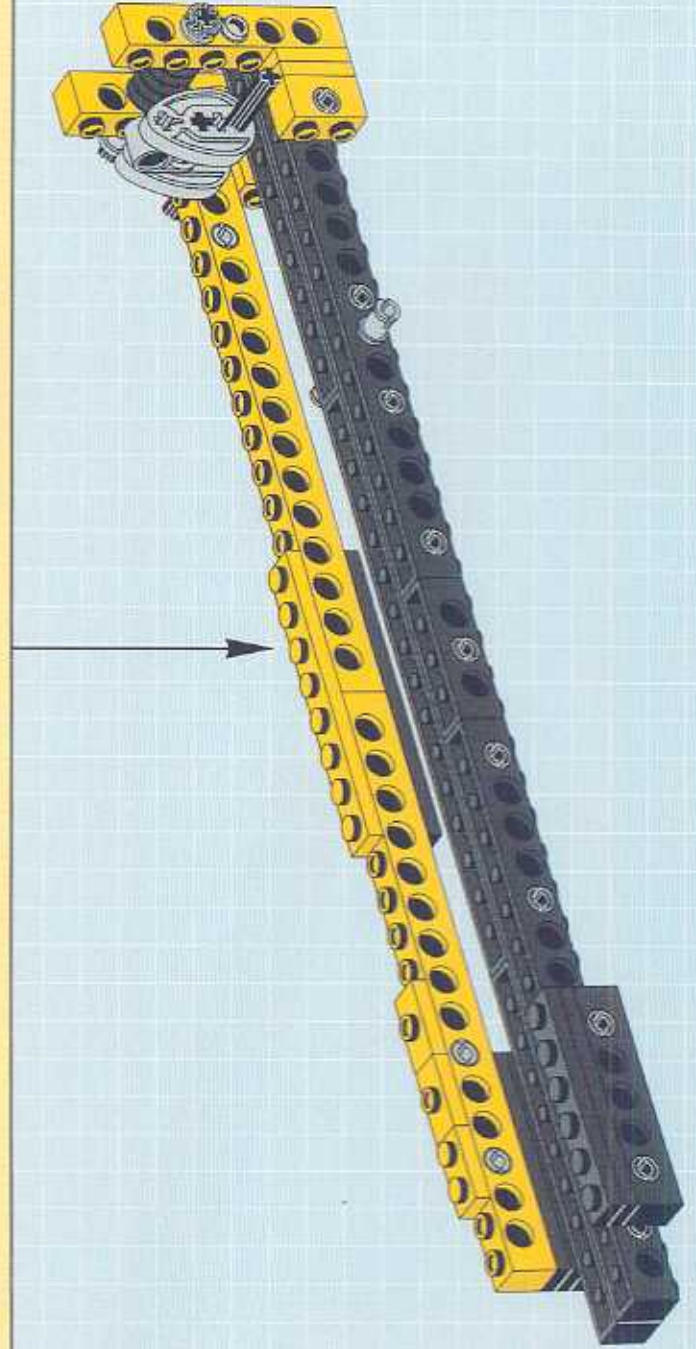
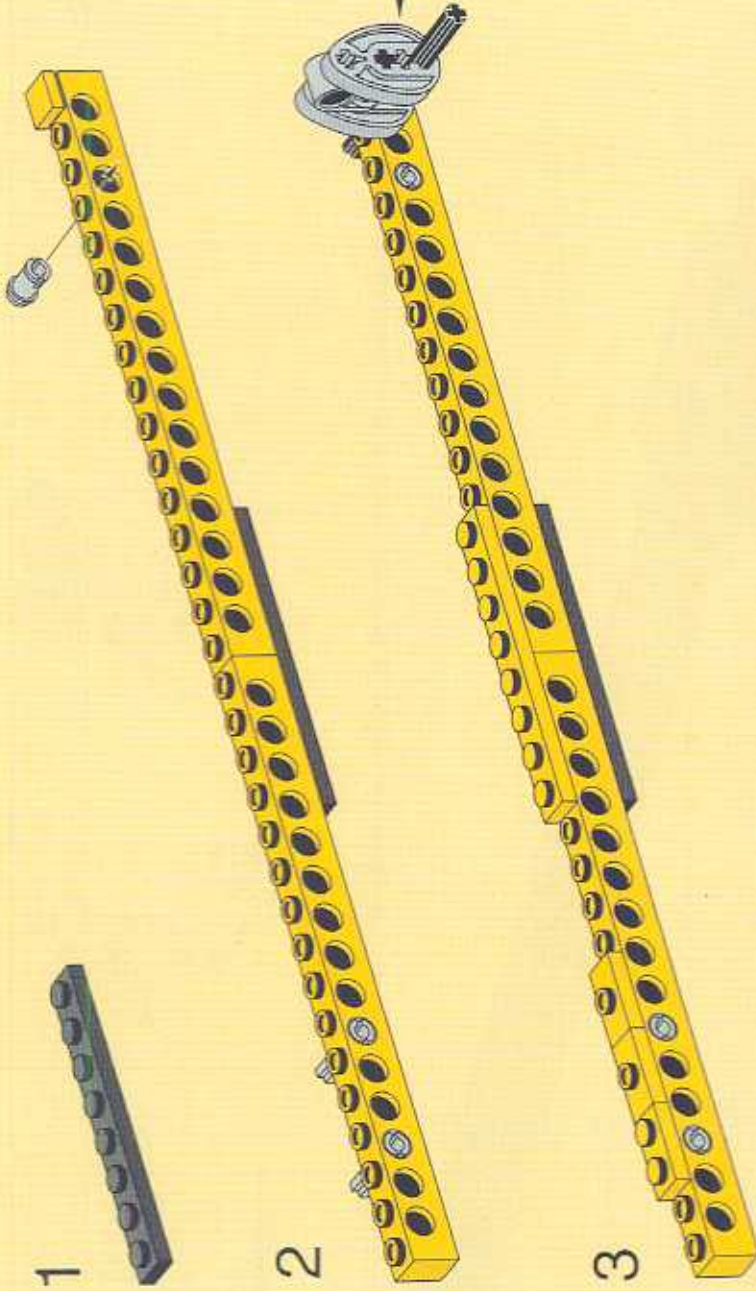
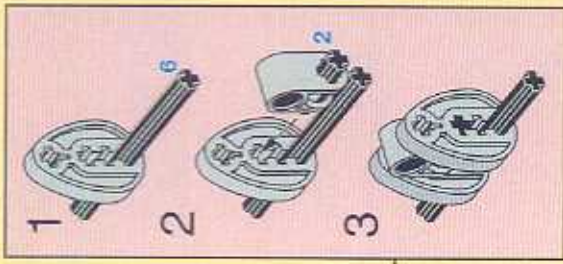

5

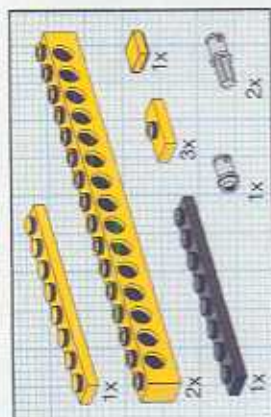
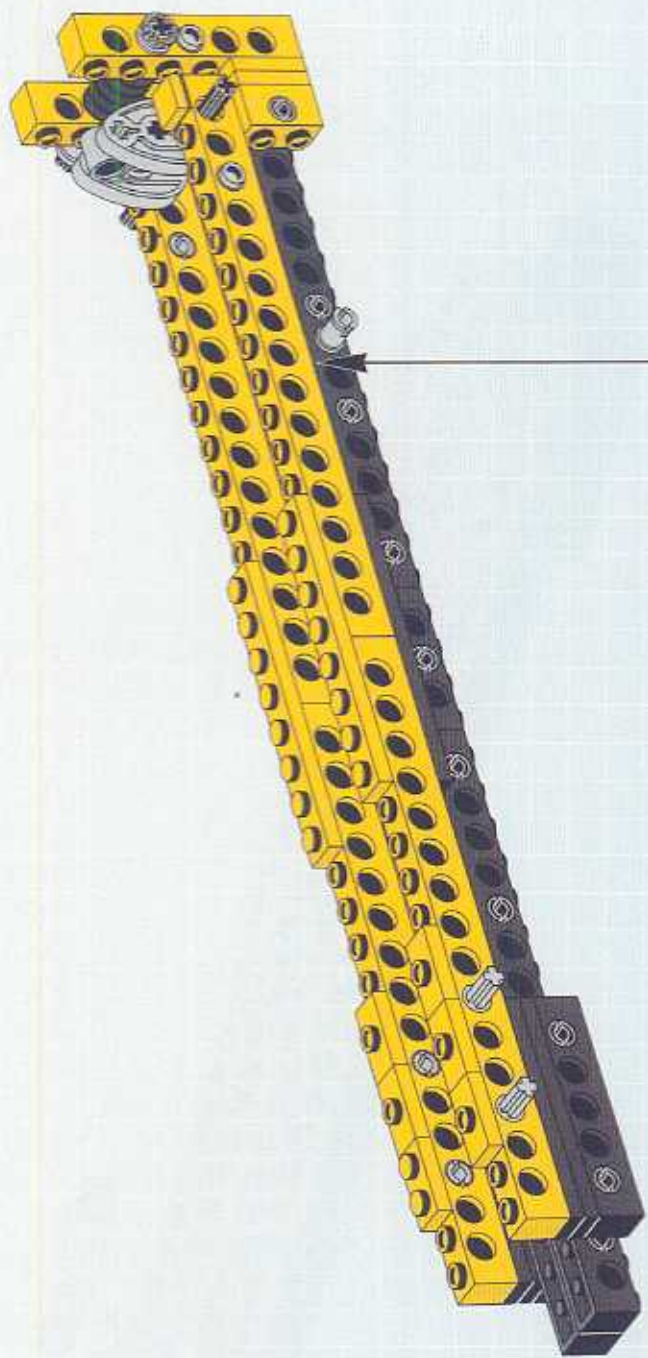

6





7

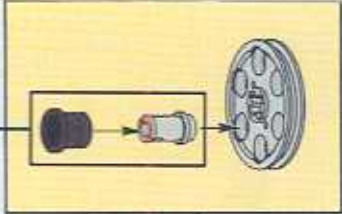

8

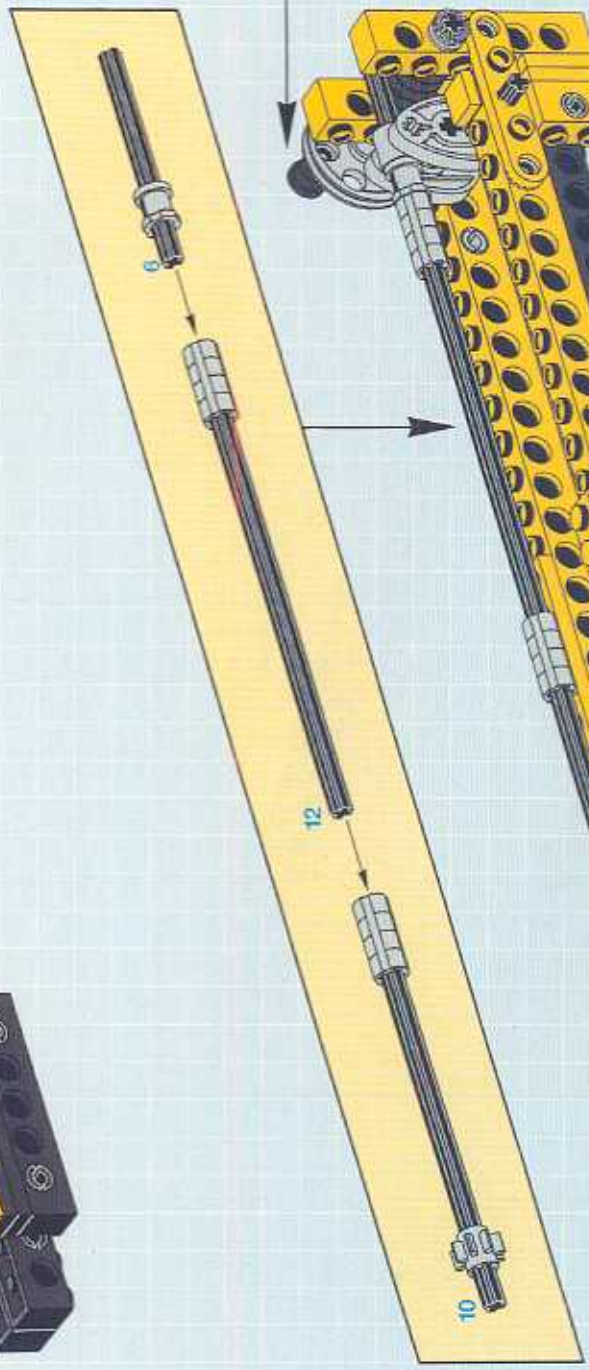



9

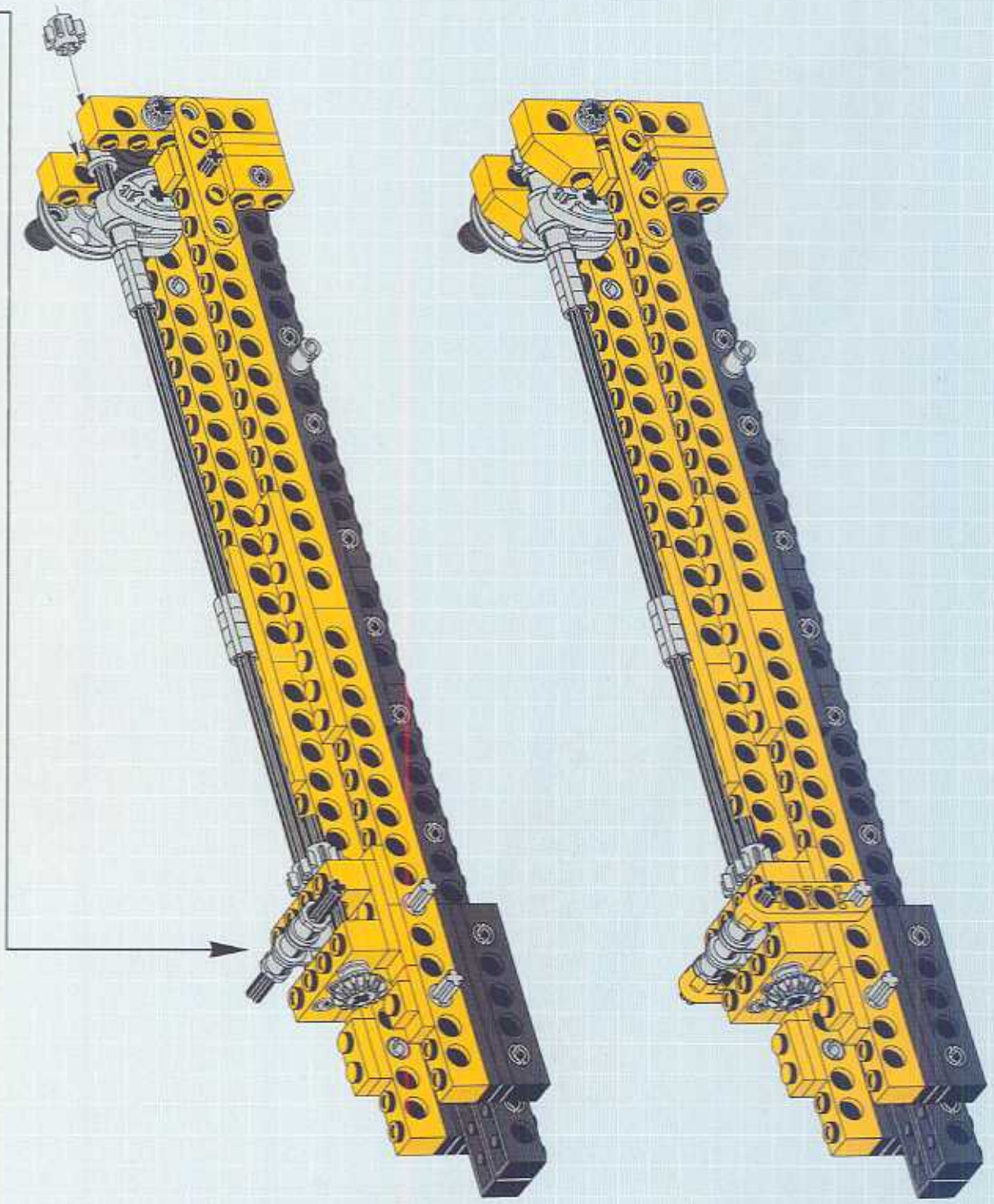
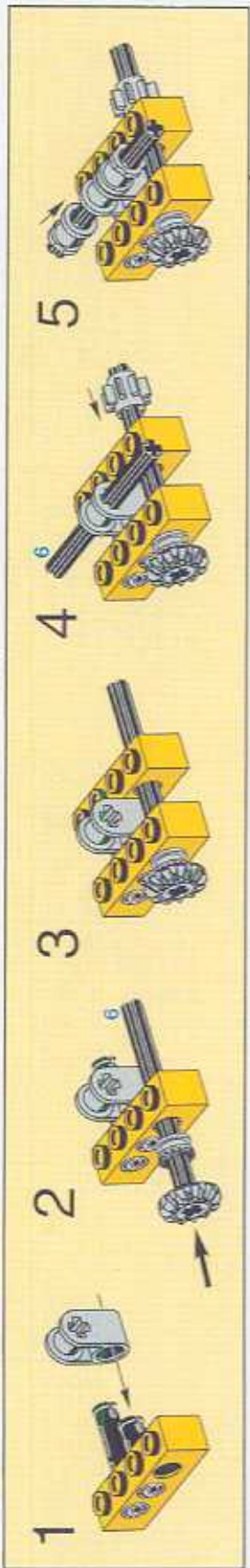

10

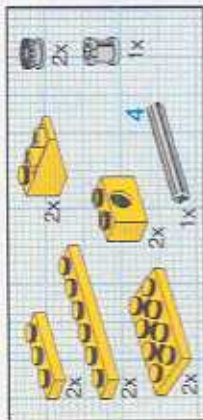

11

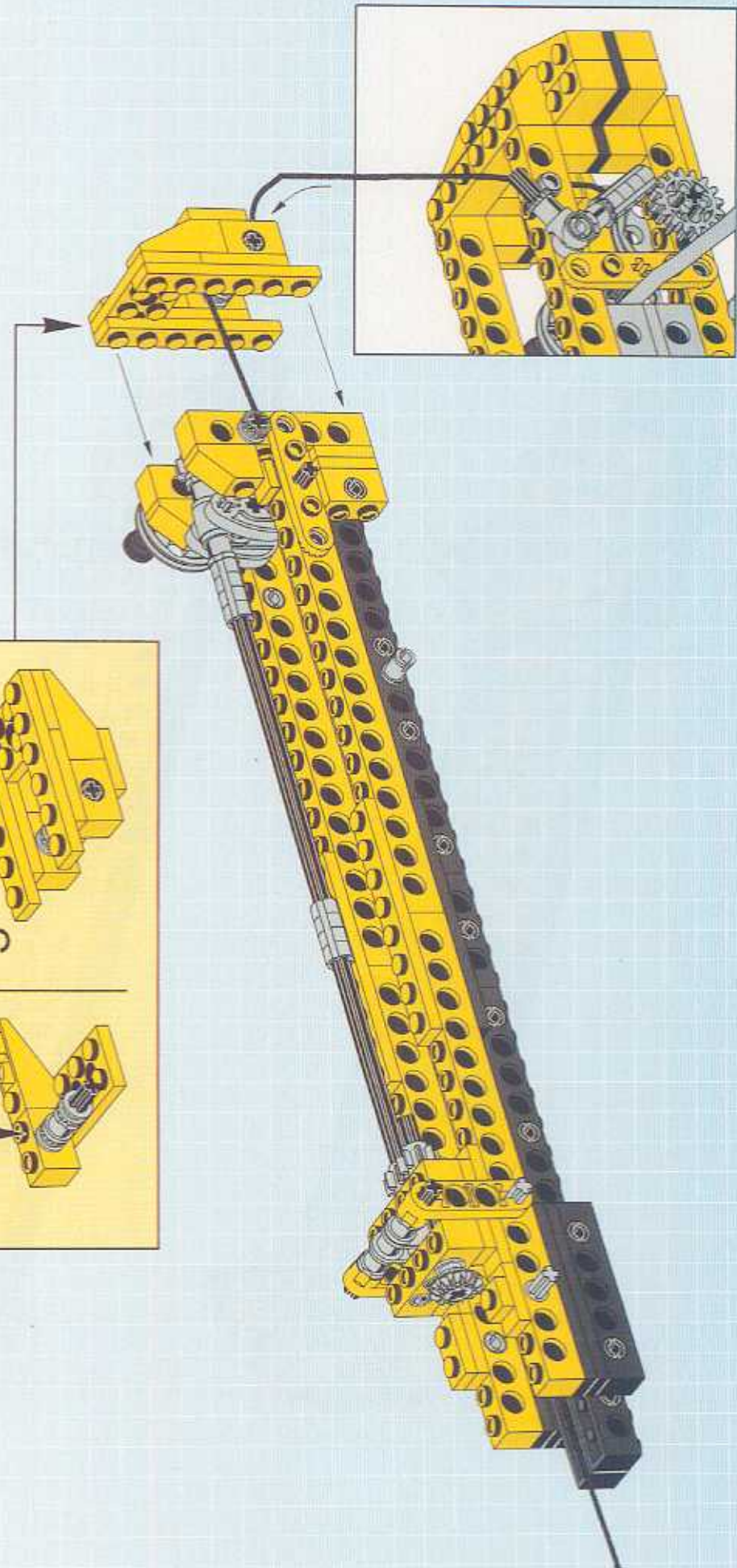
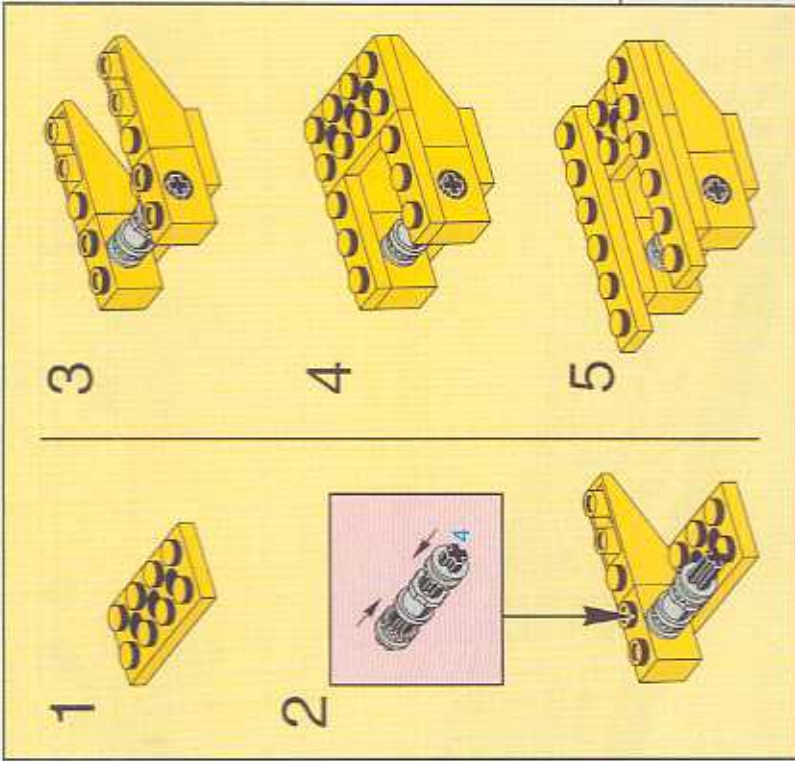



15



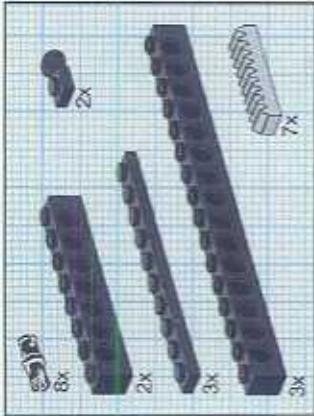

17

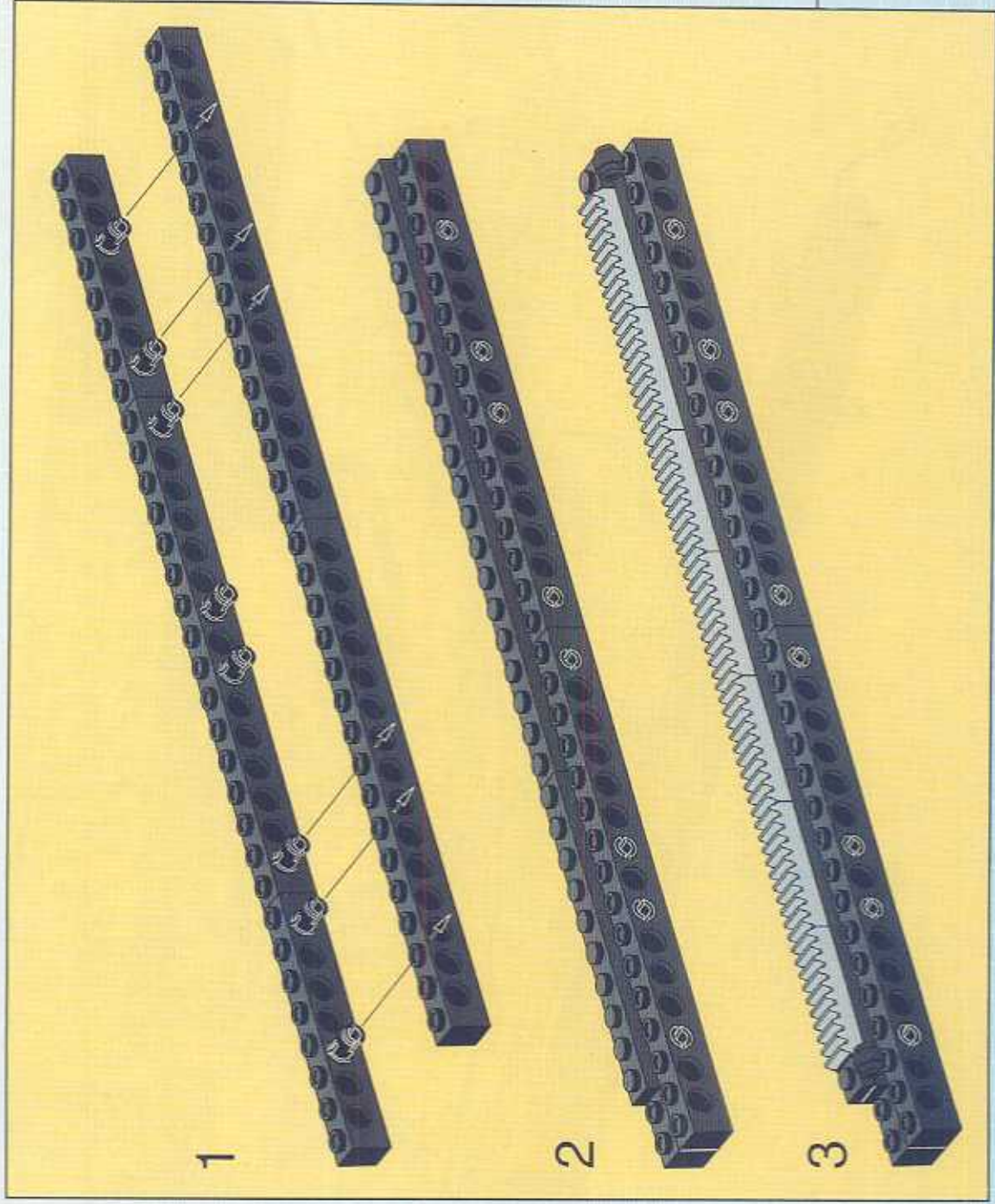

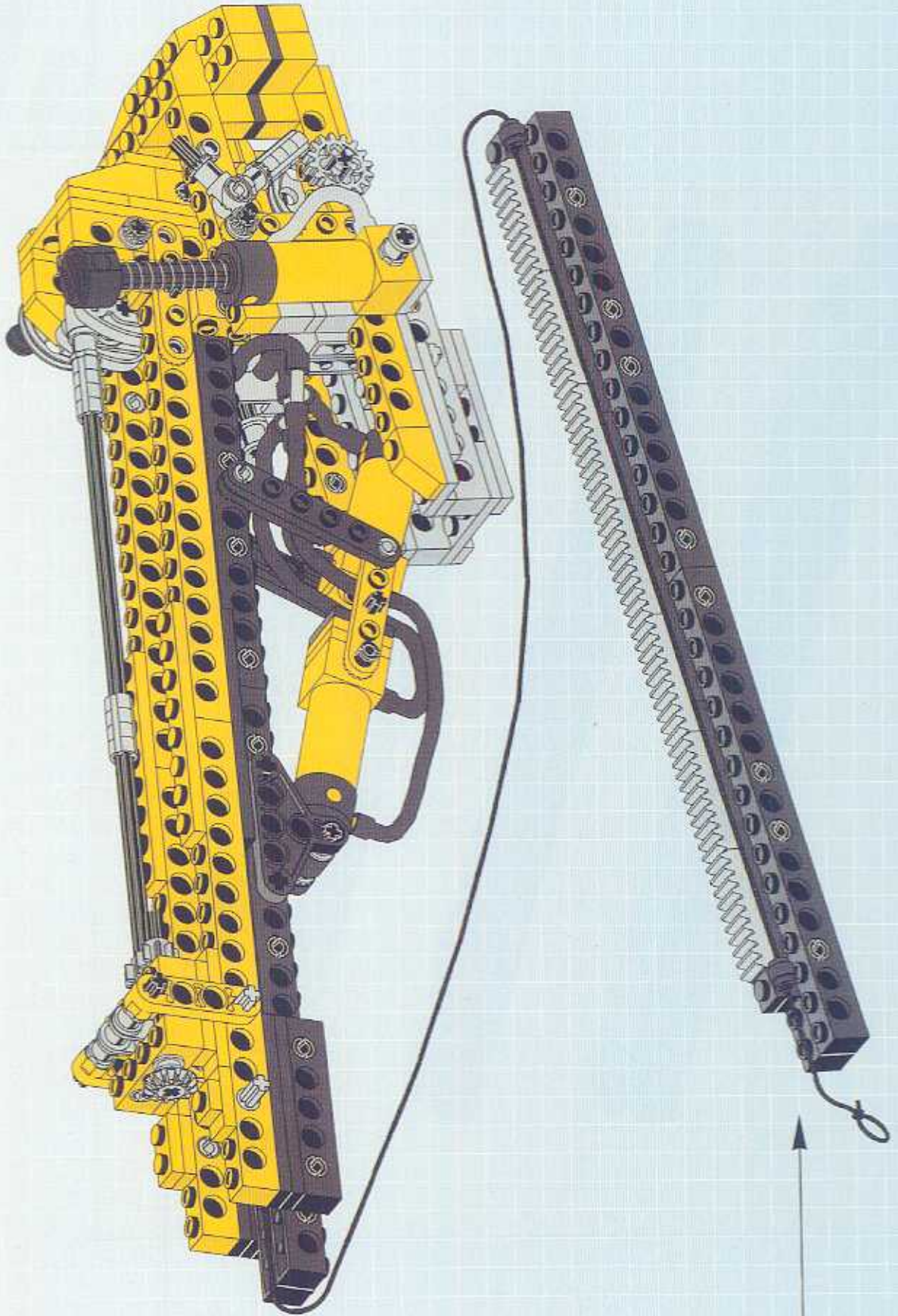

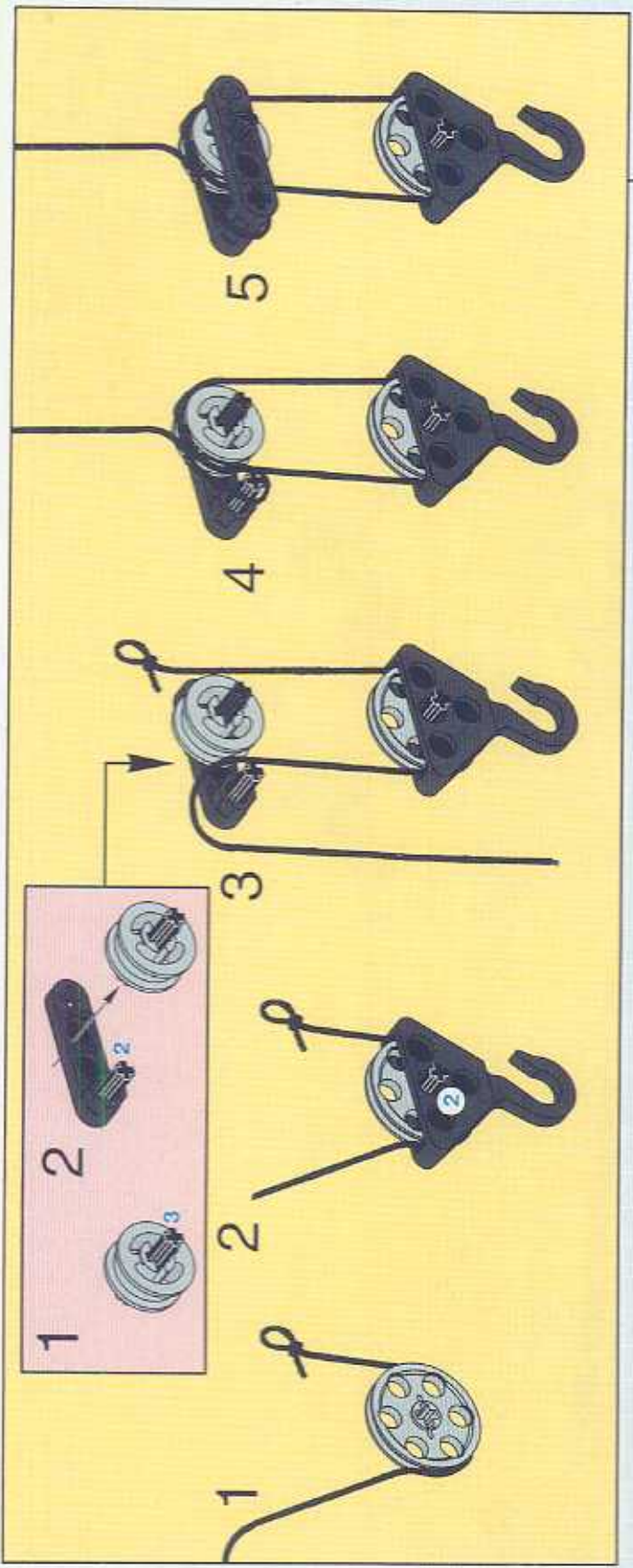

18



19

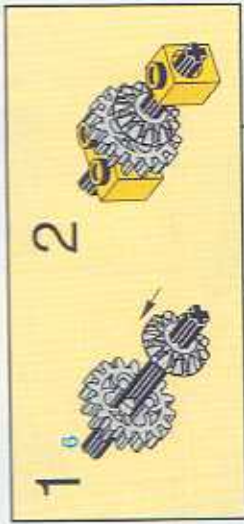



20

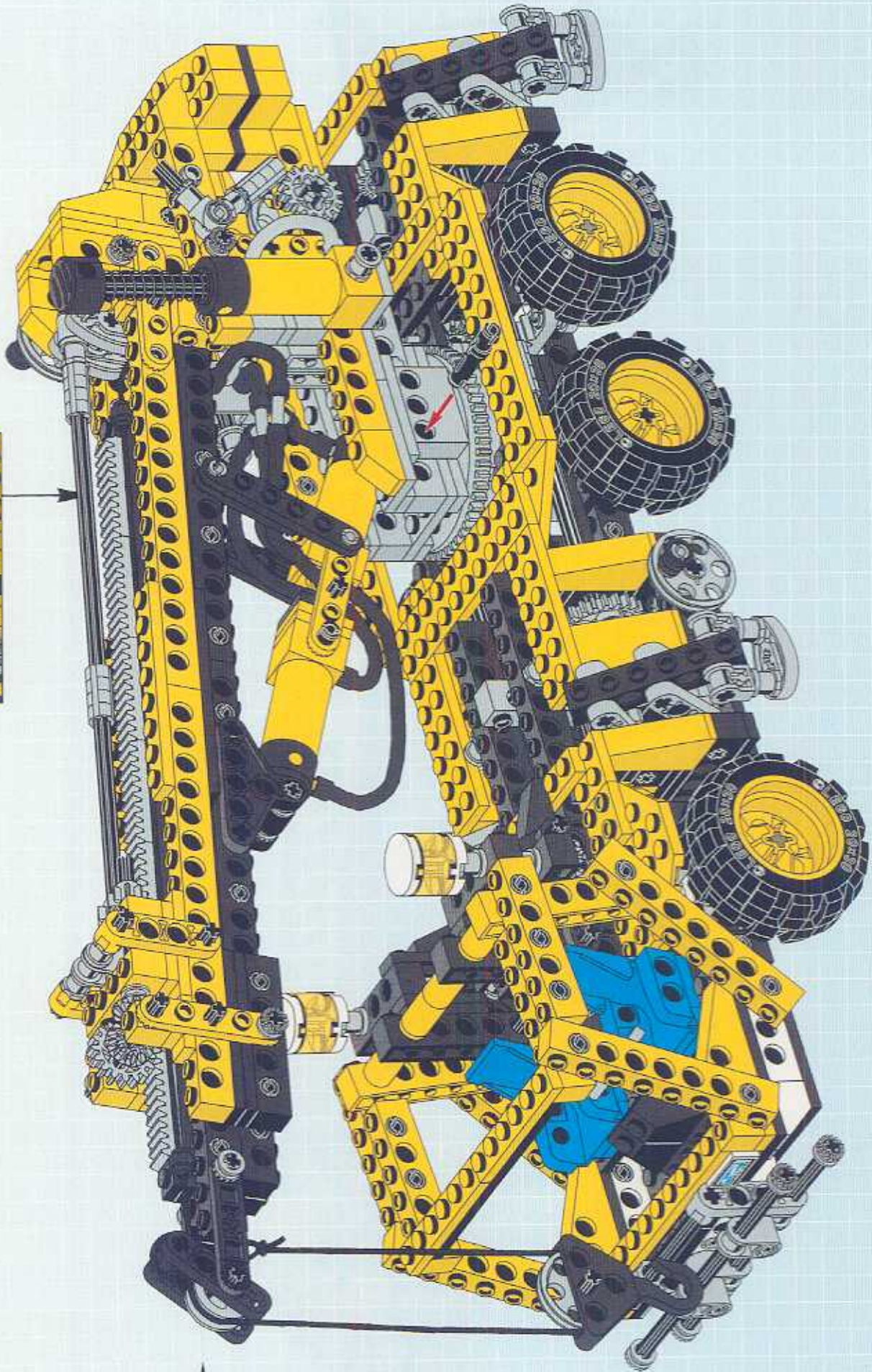
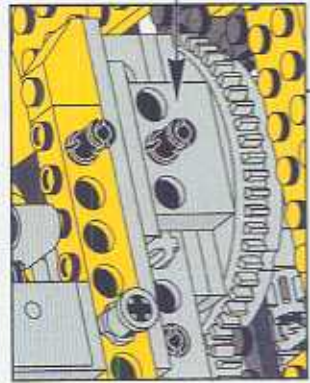

32



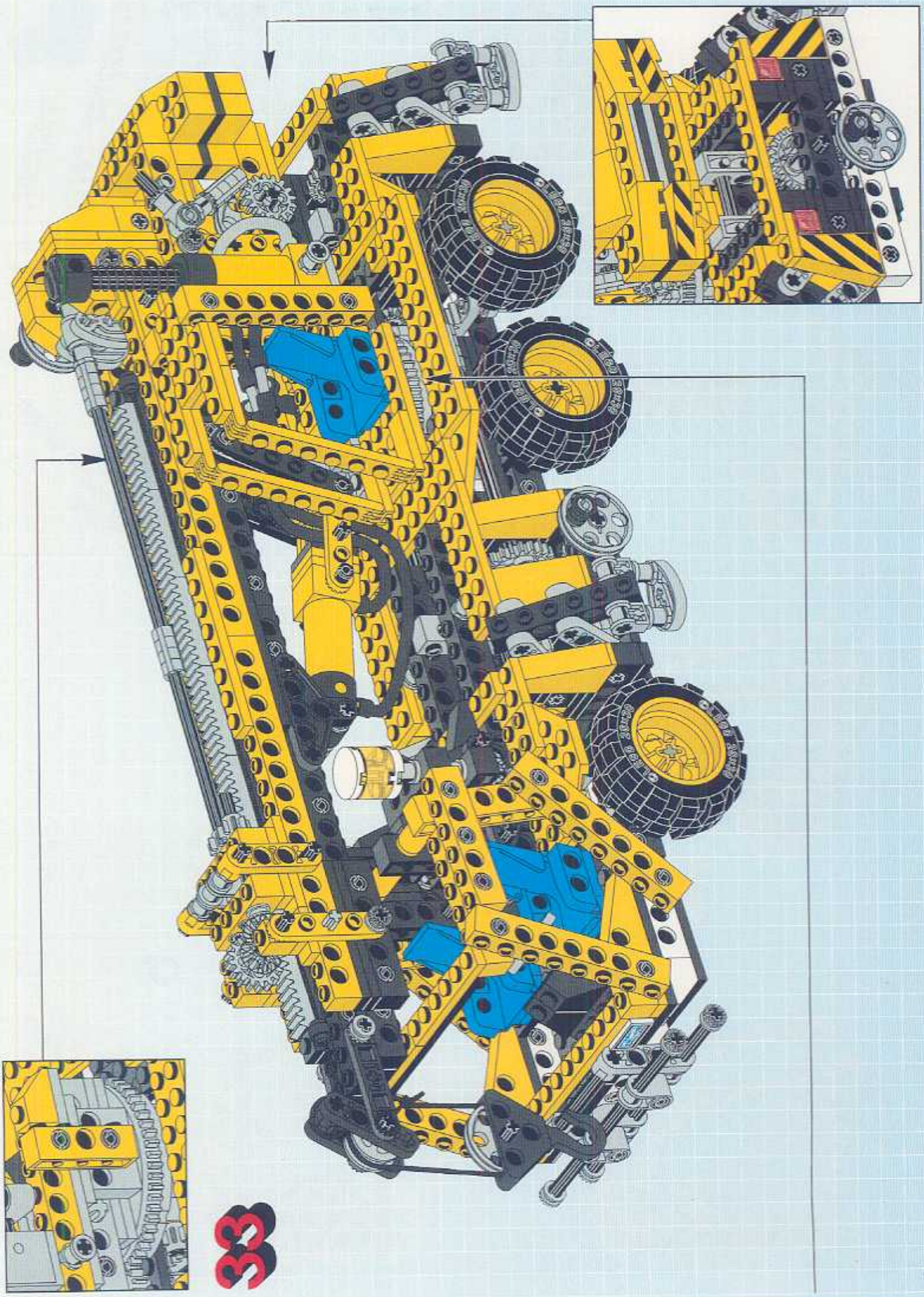

33

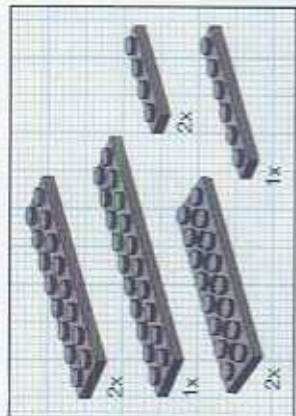
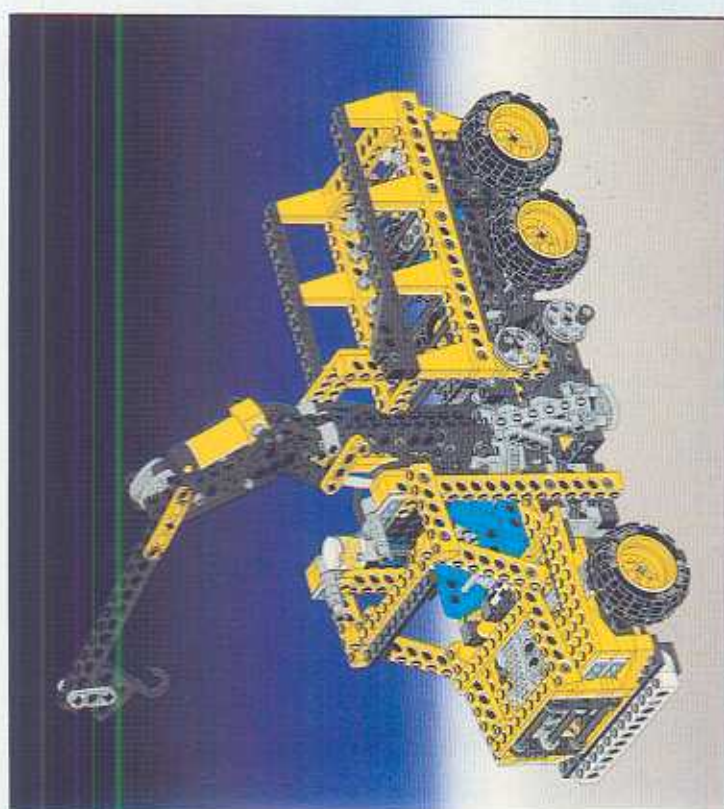

1

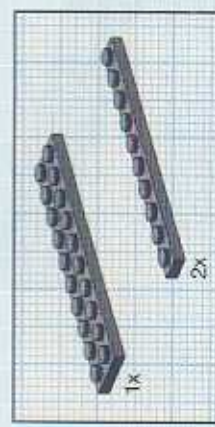
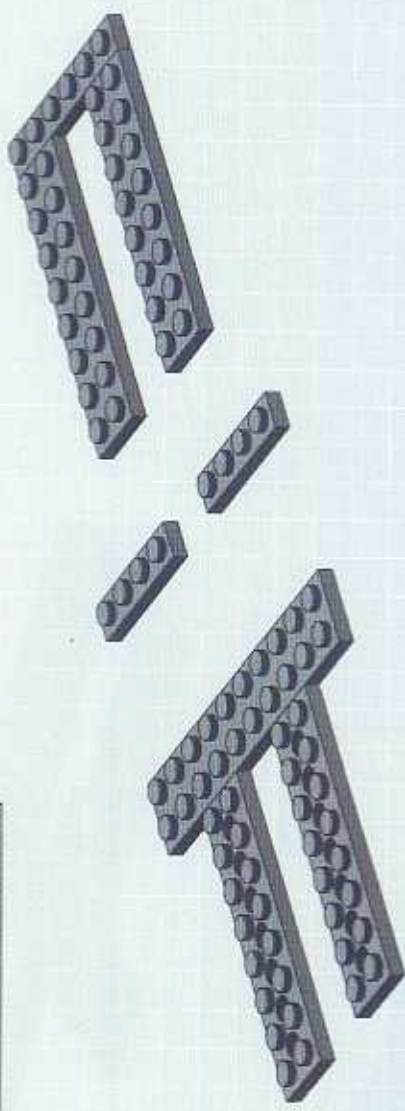

2

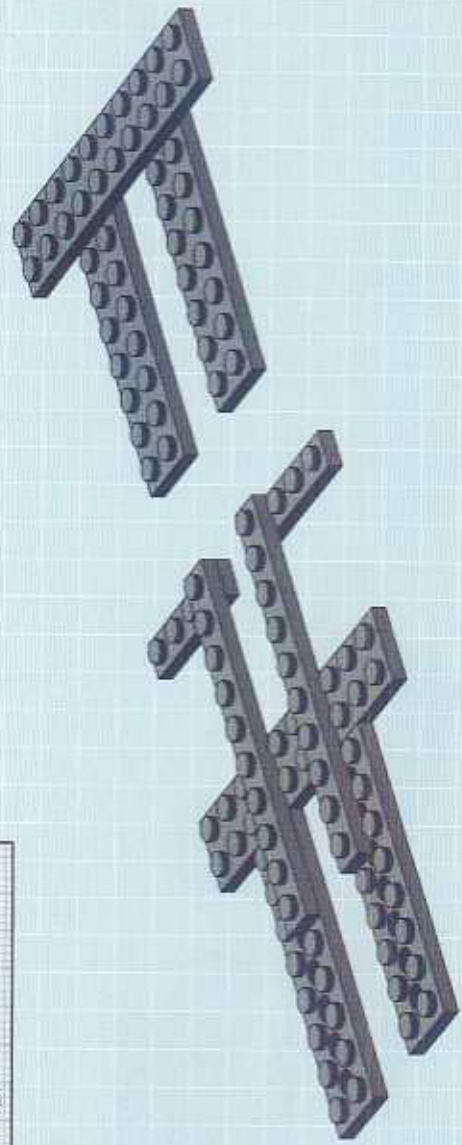

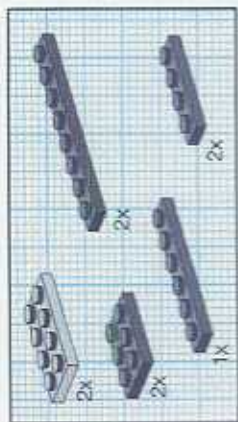

3

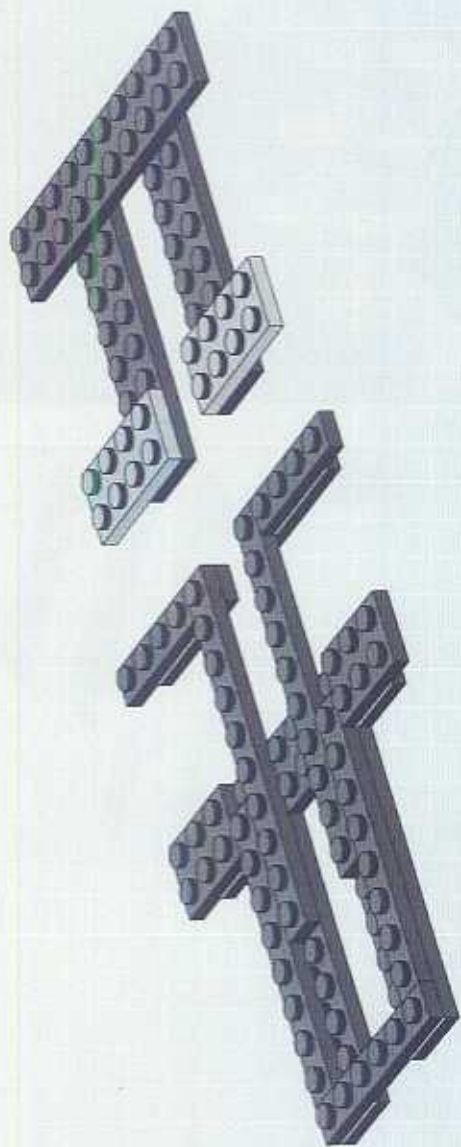

4

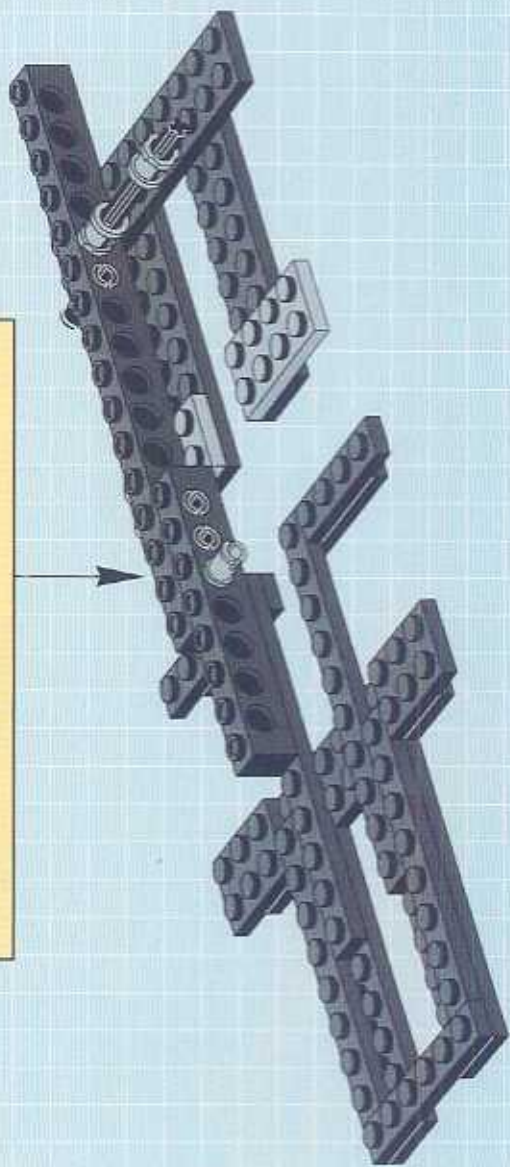
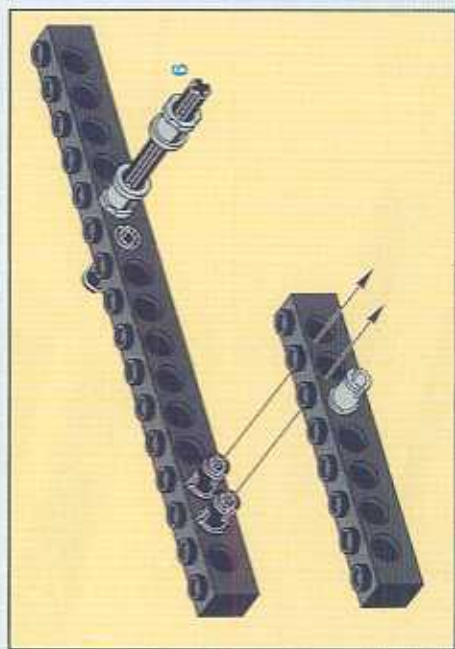

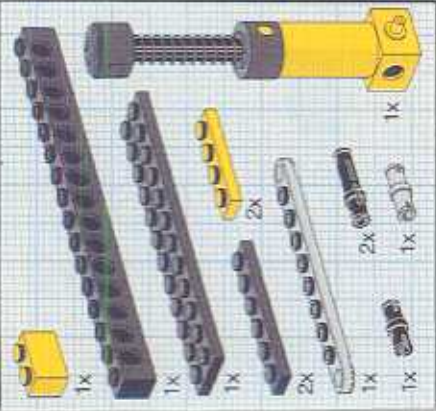

5

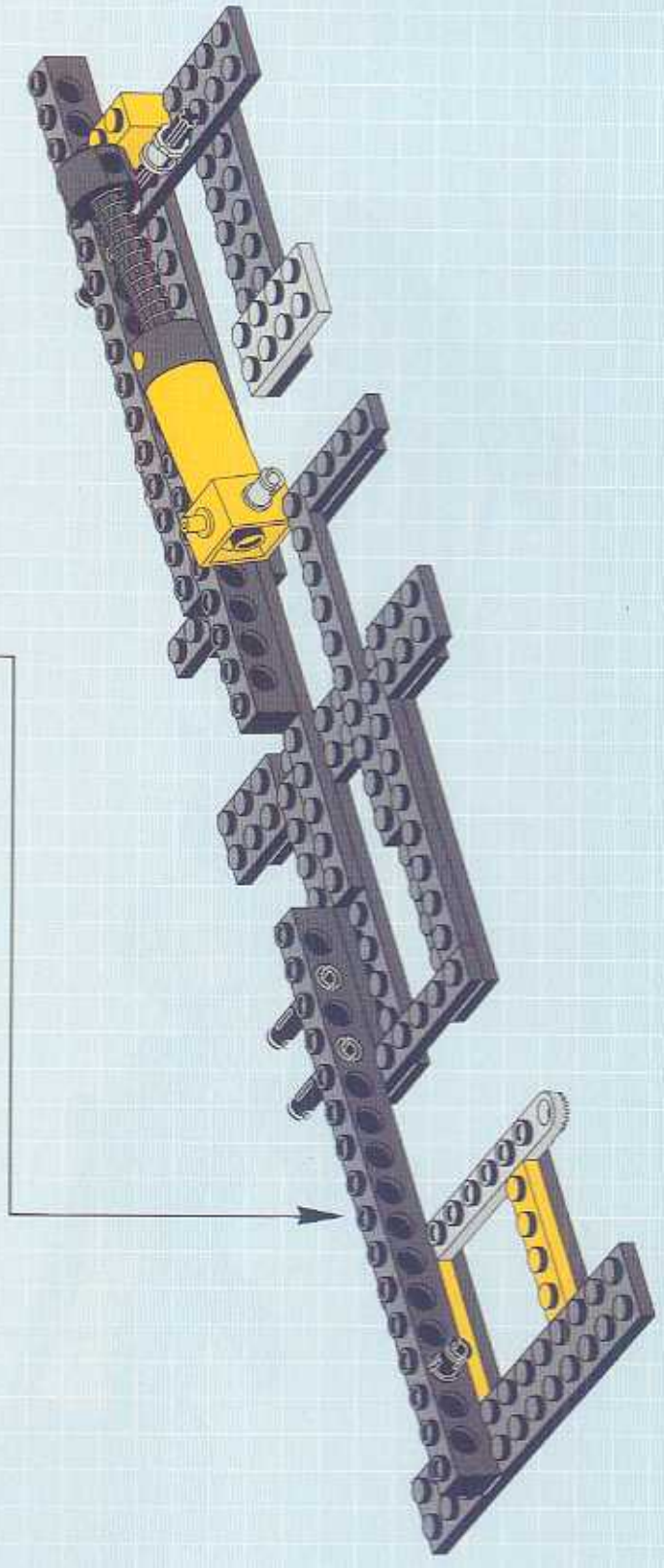
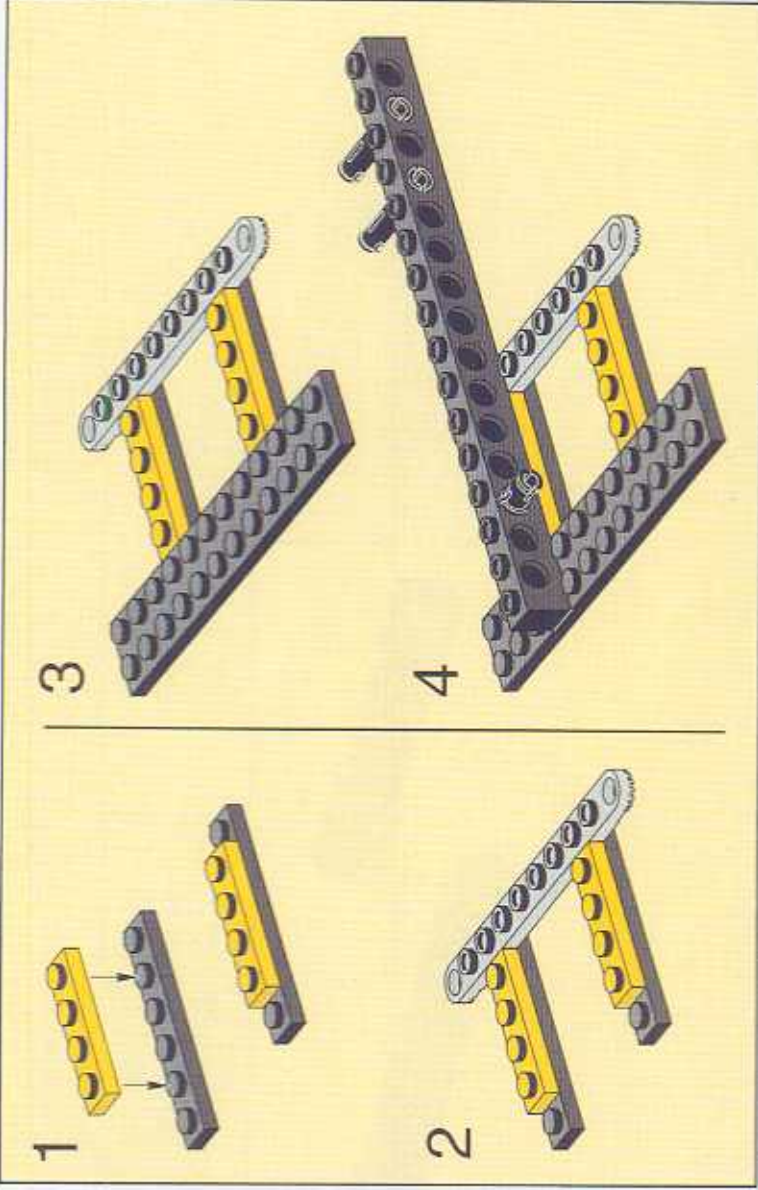

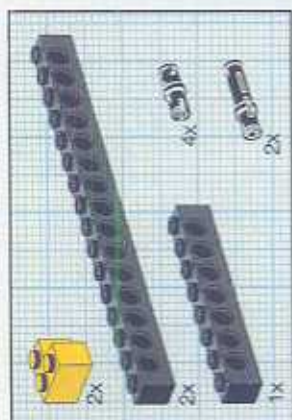
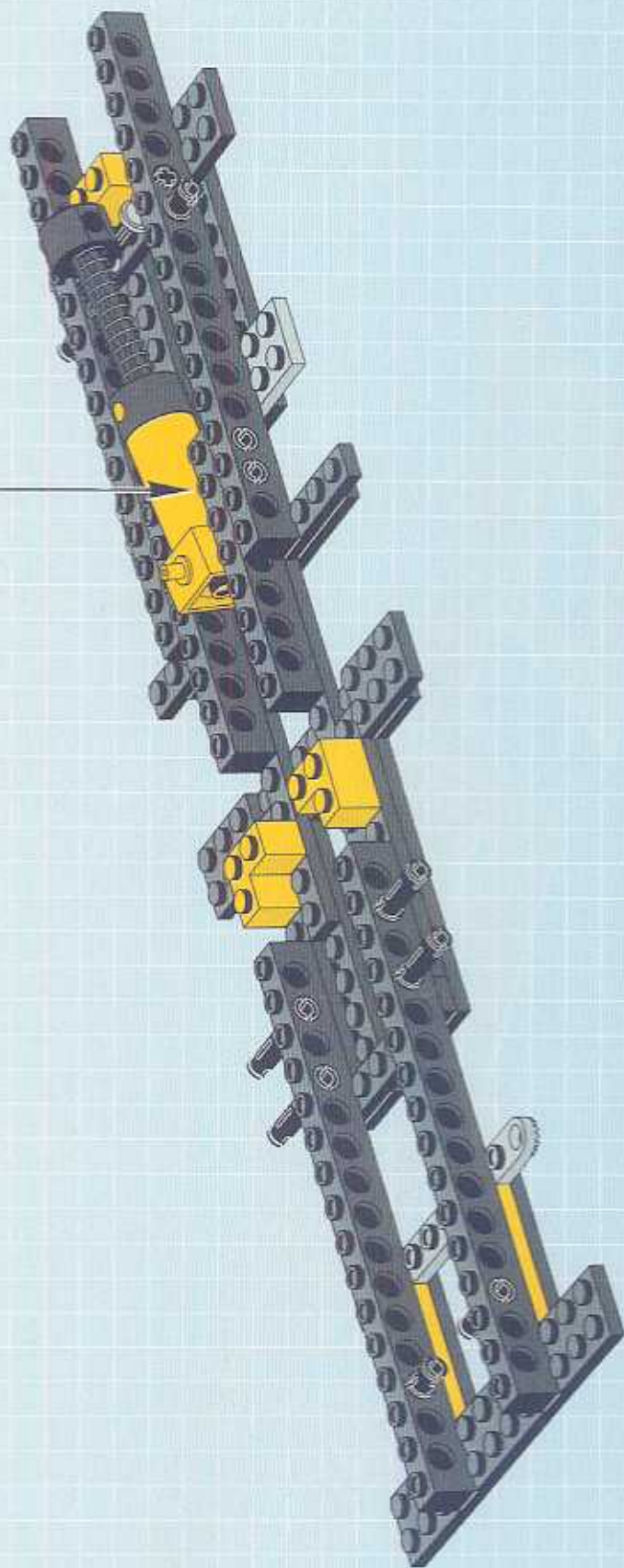
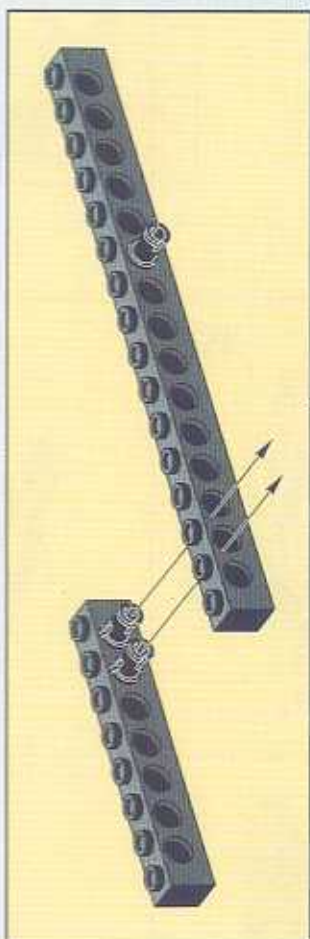

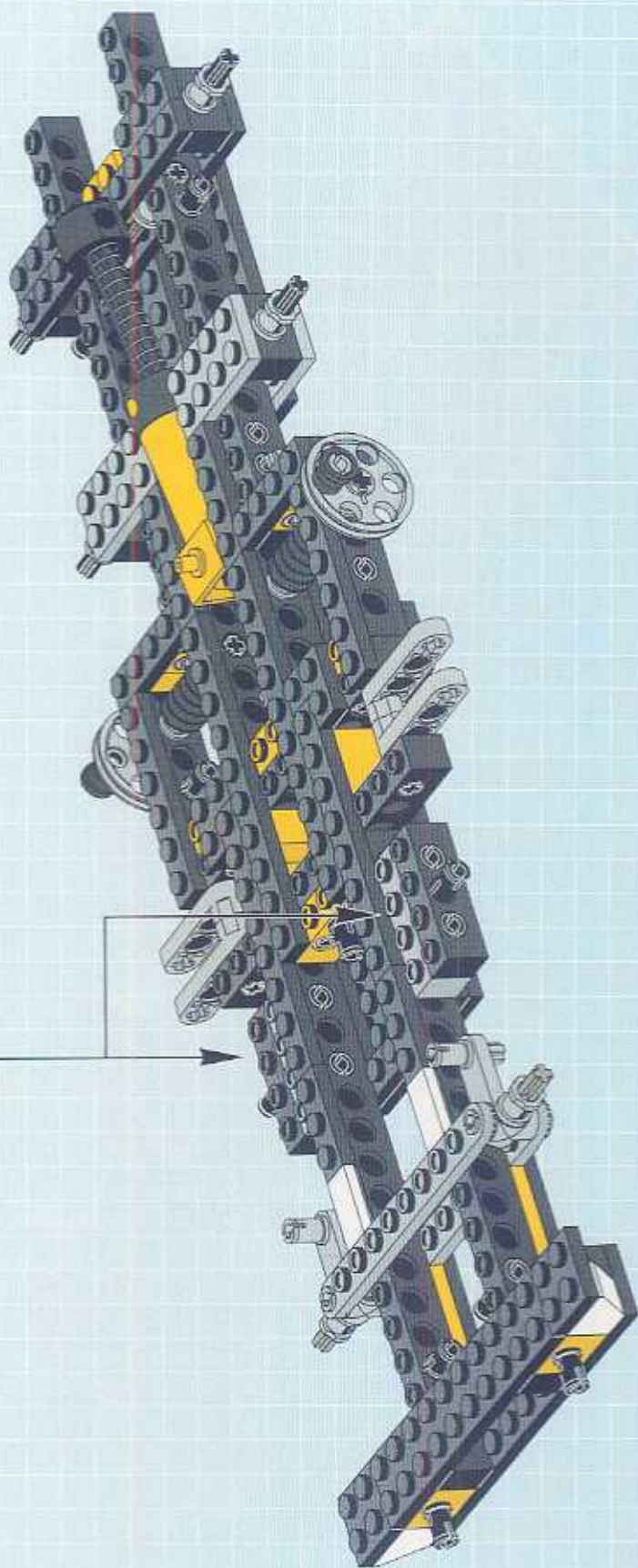
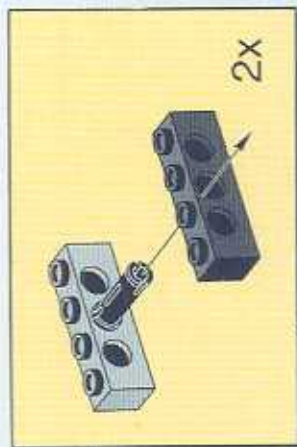

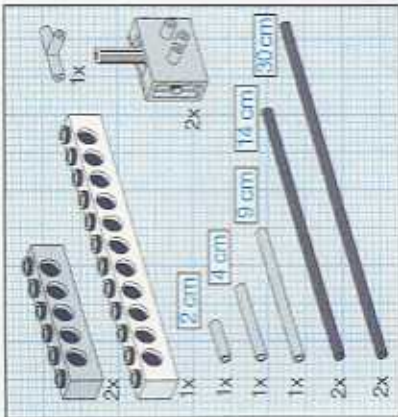

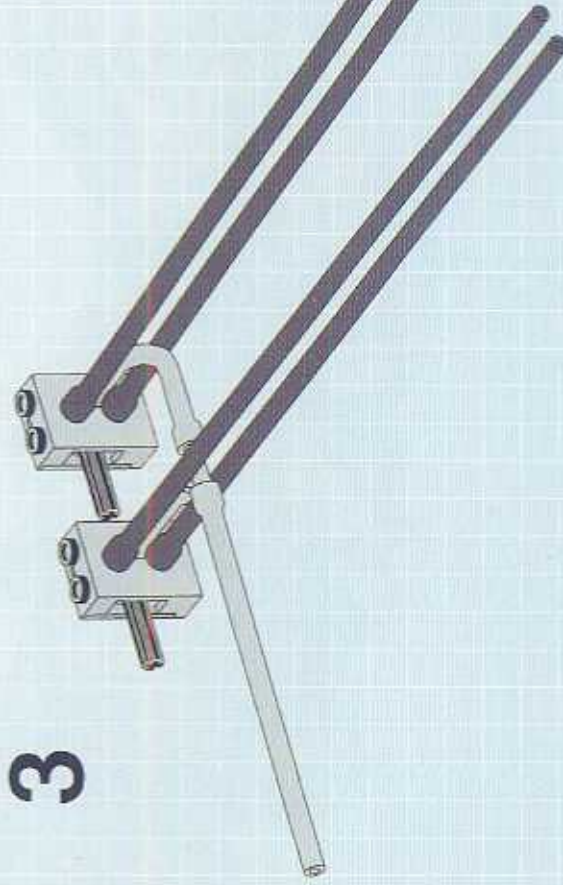
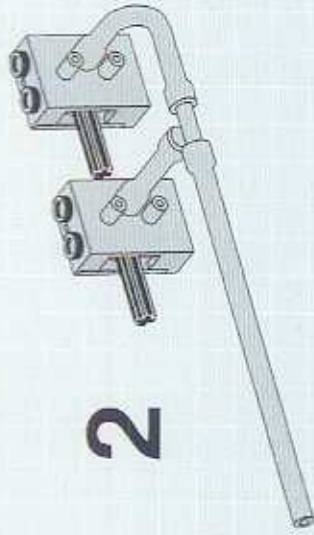
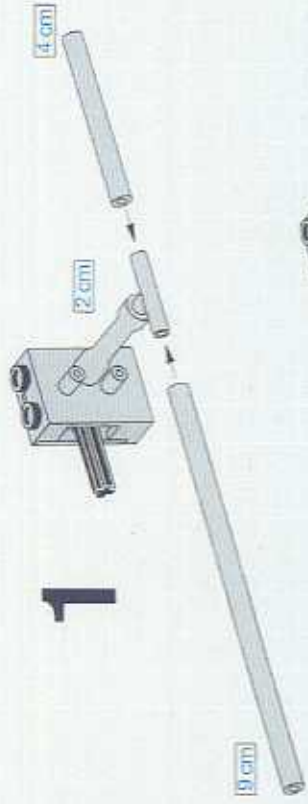

13

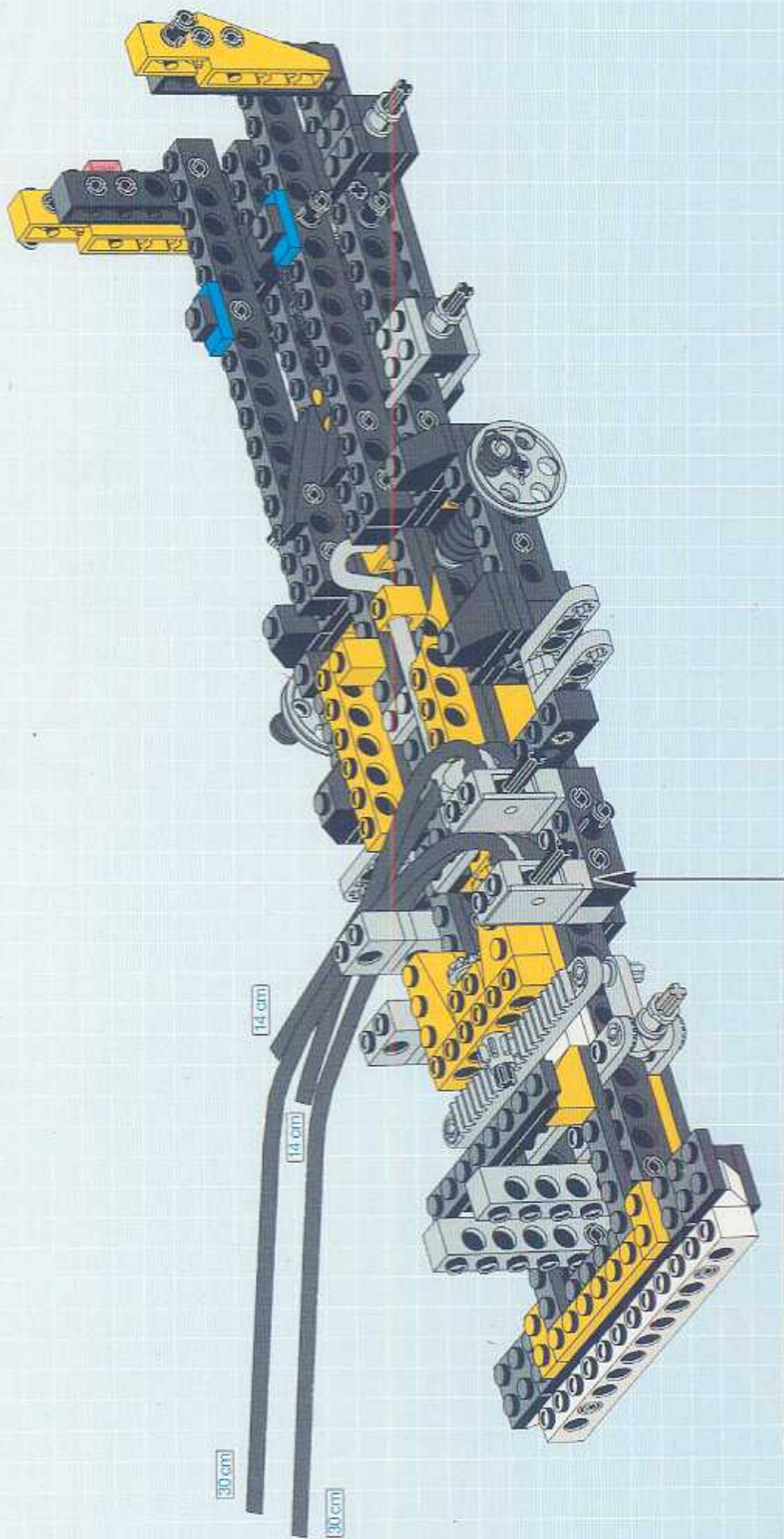

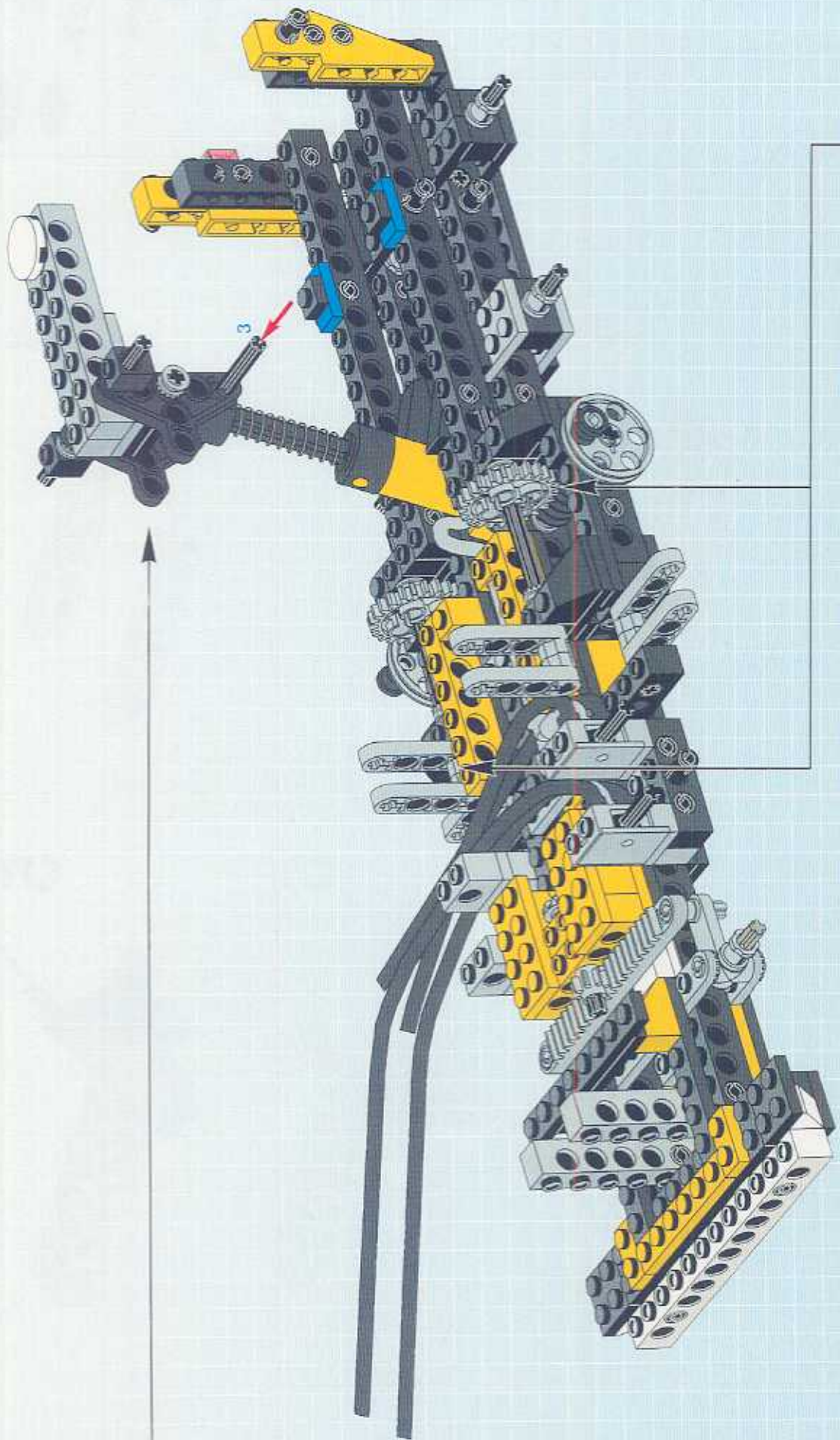

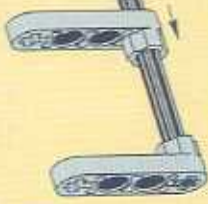
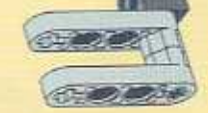

- 1 
 - 2 
 - 3 
 - 4 
- 2x

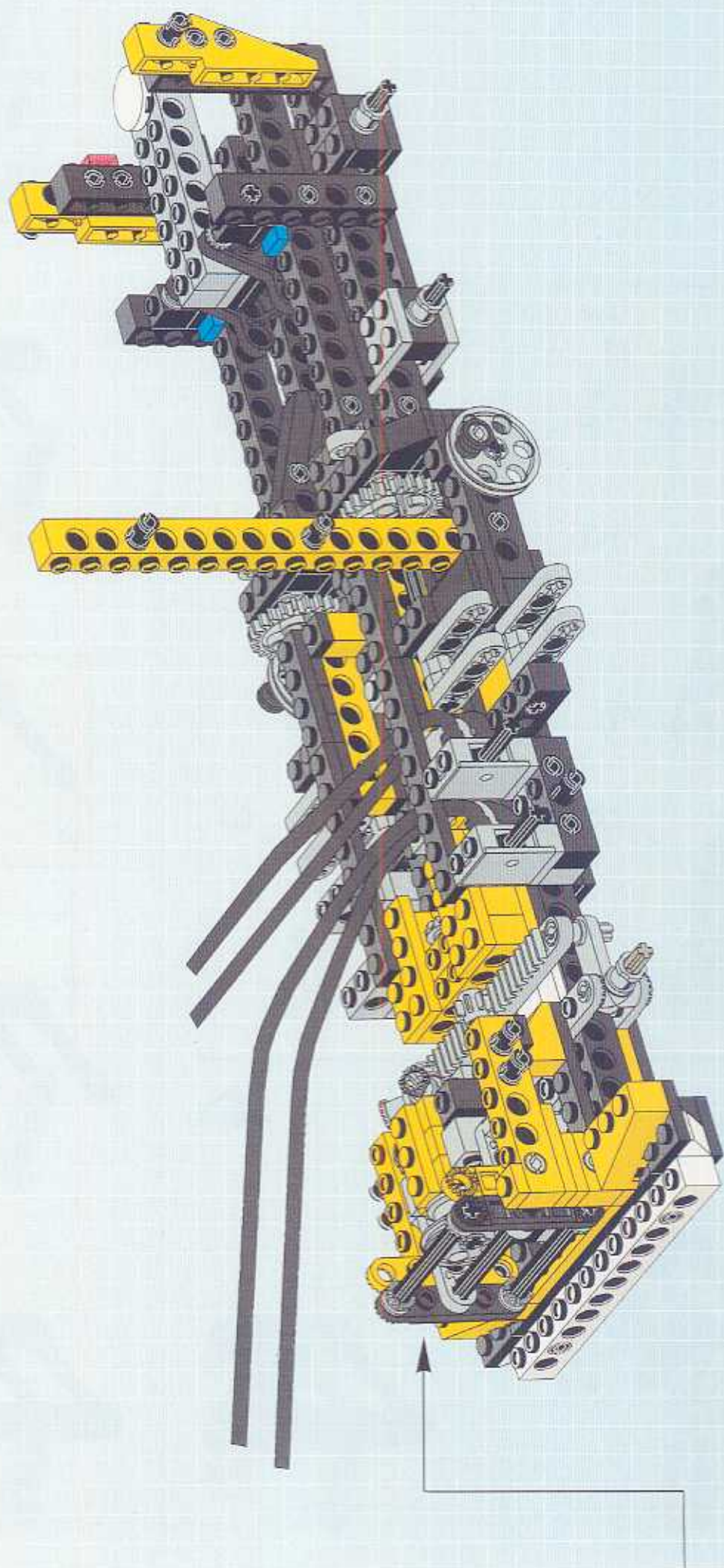

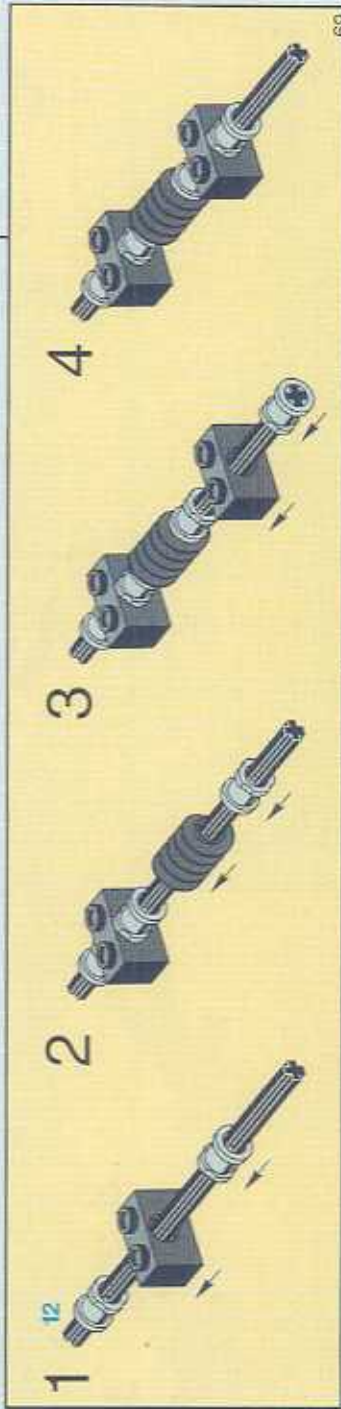
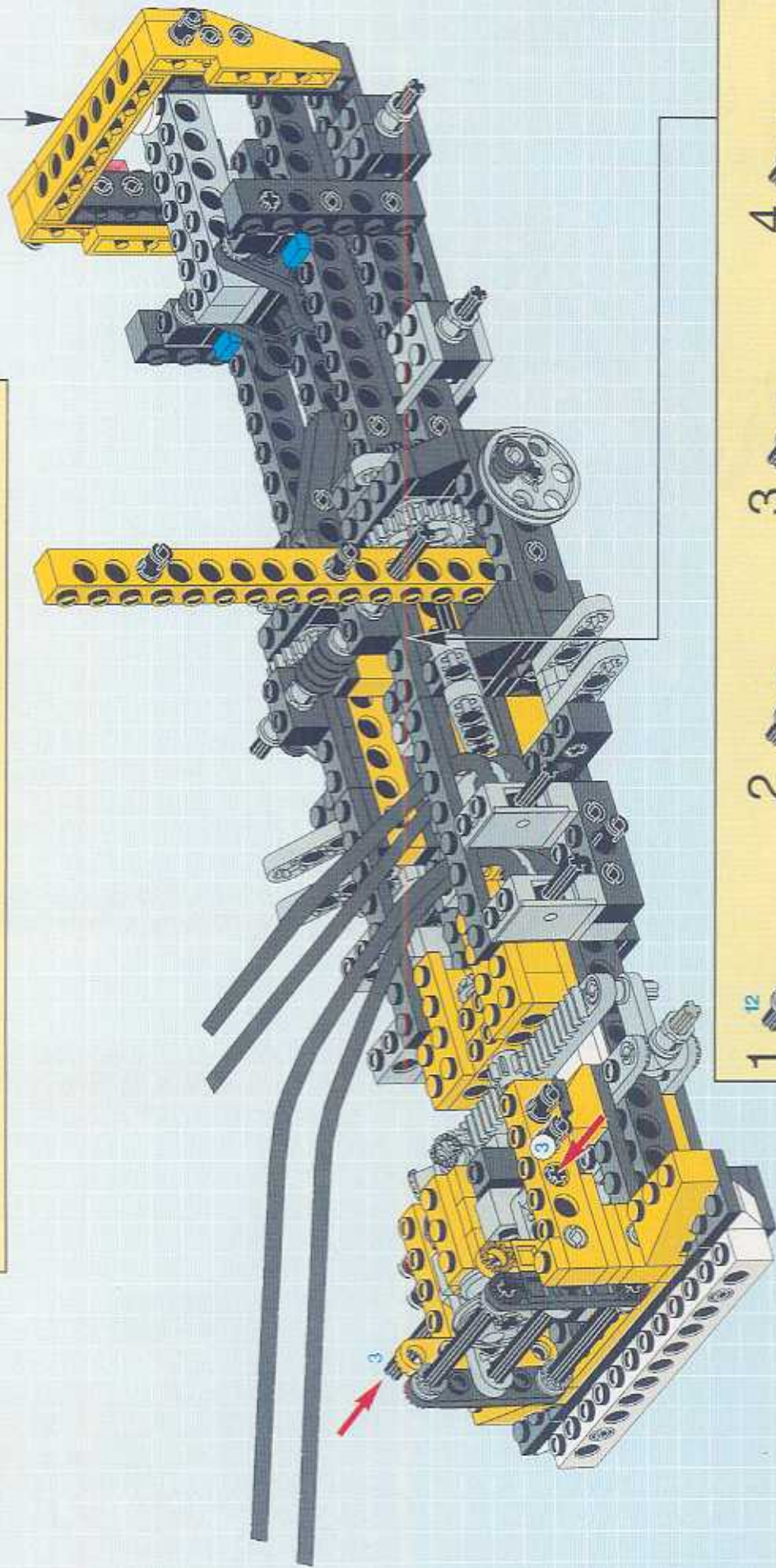
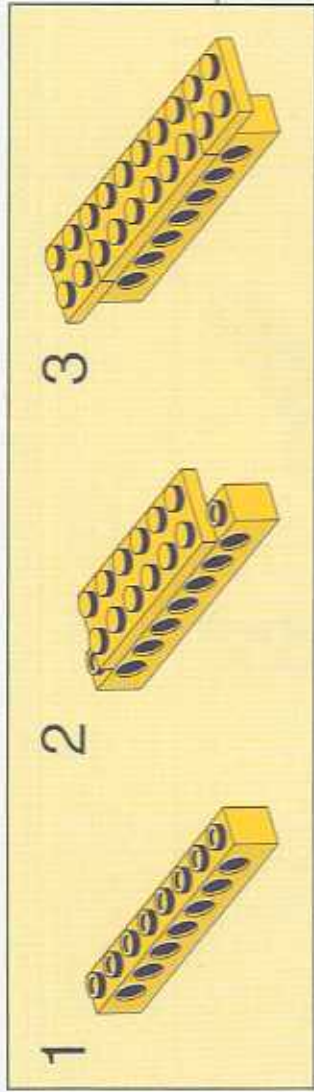
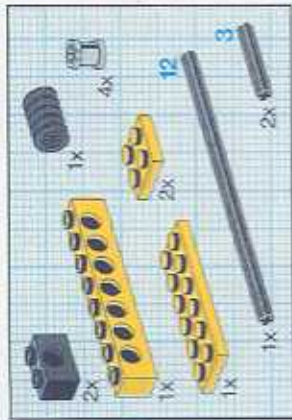

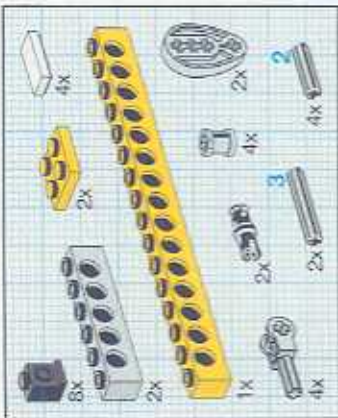

19

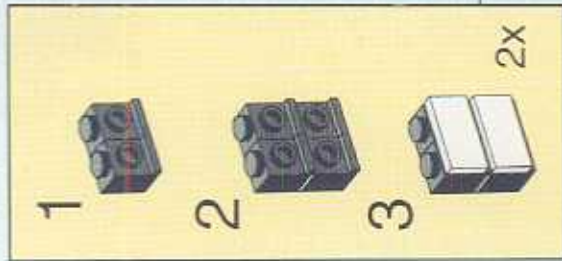
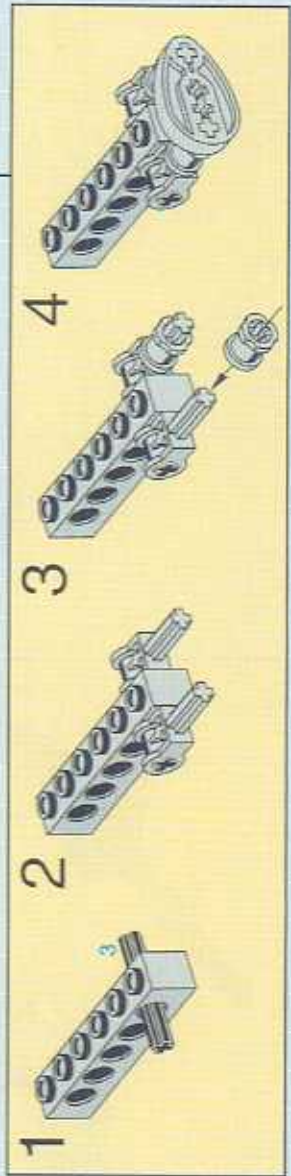
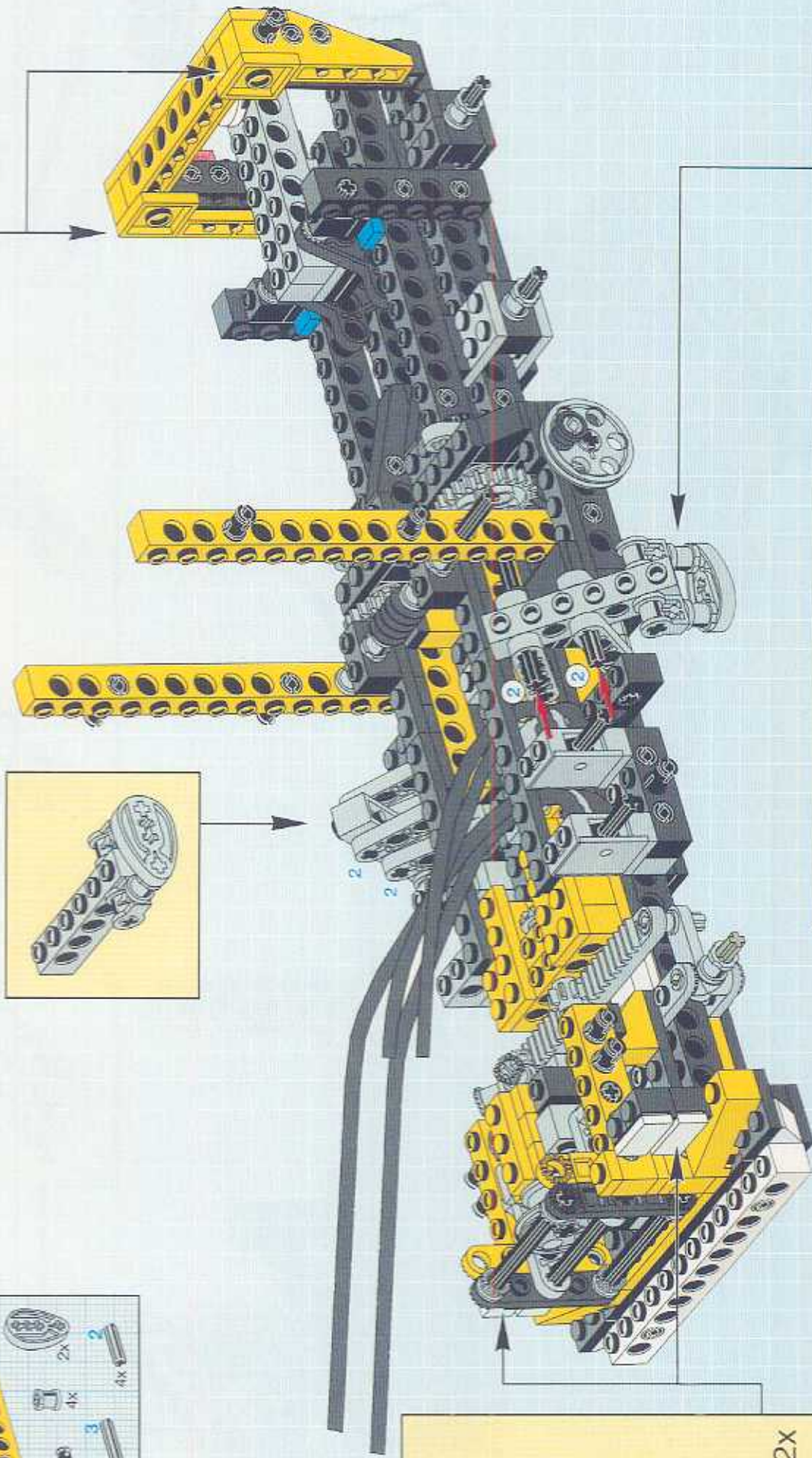

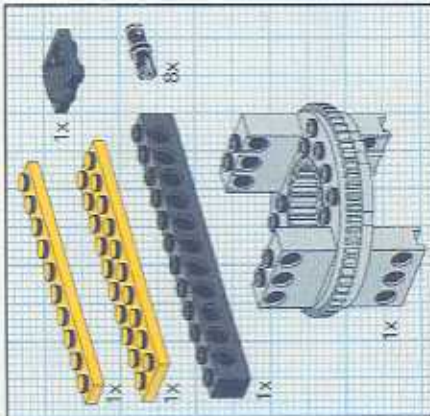
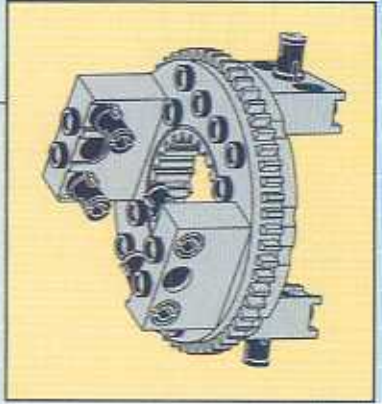
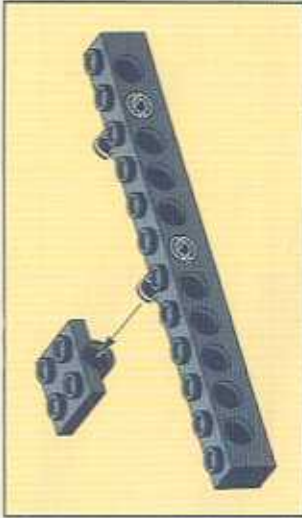
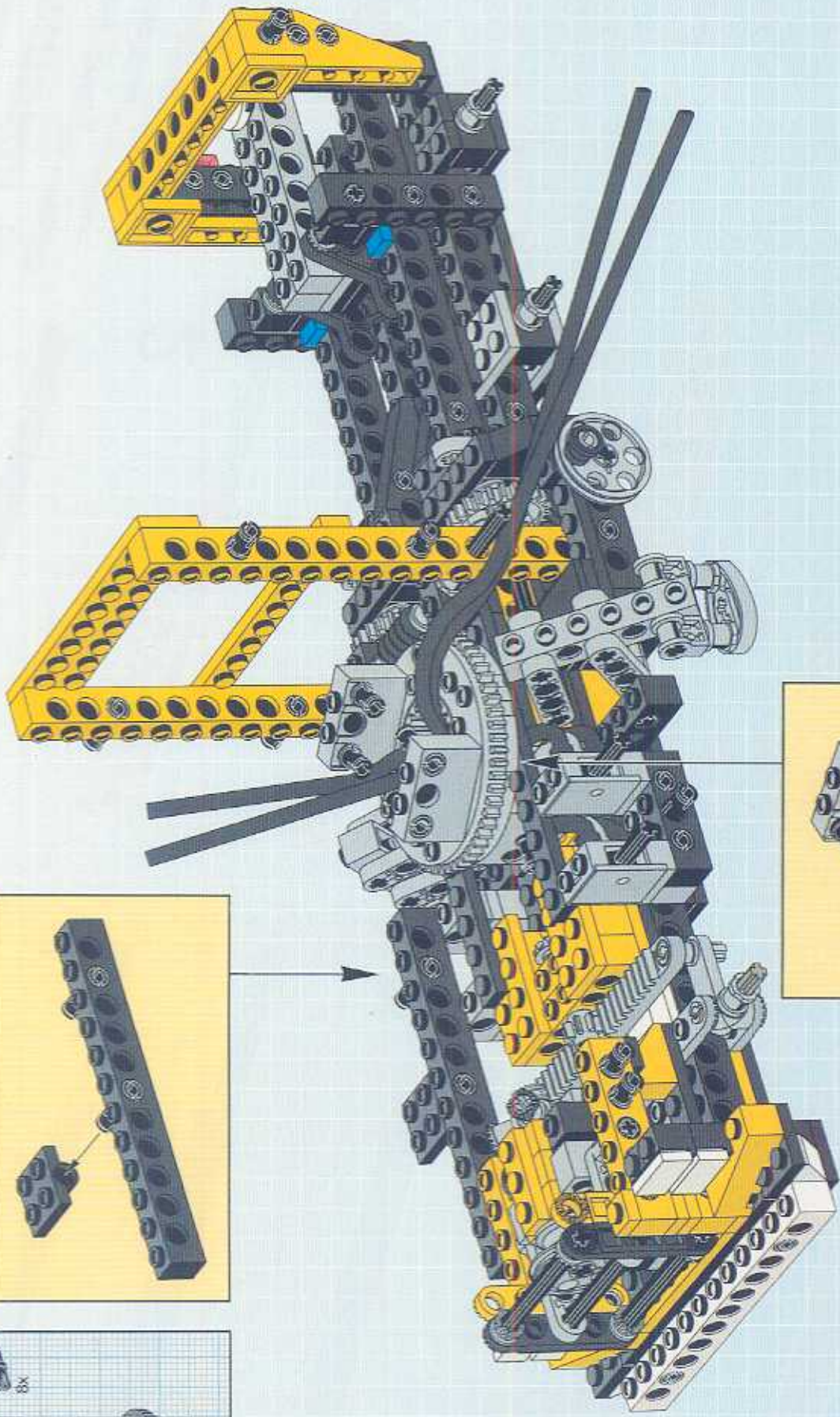

20

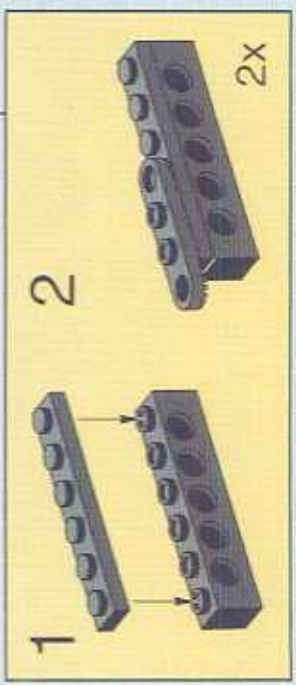
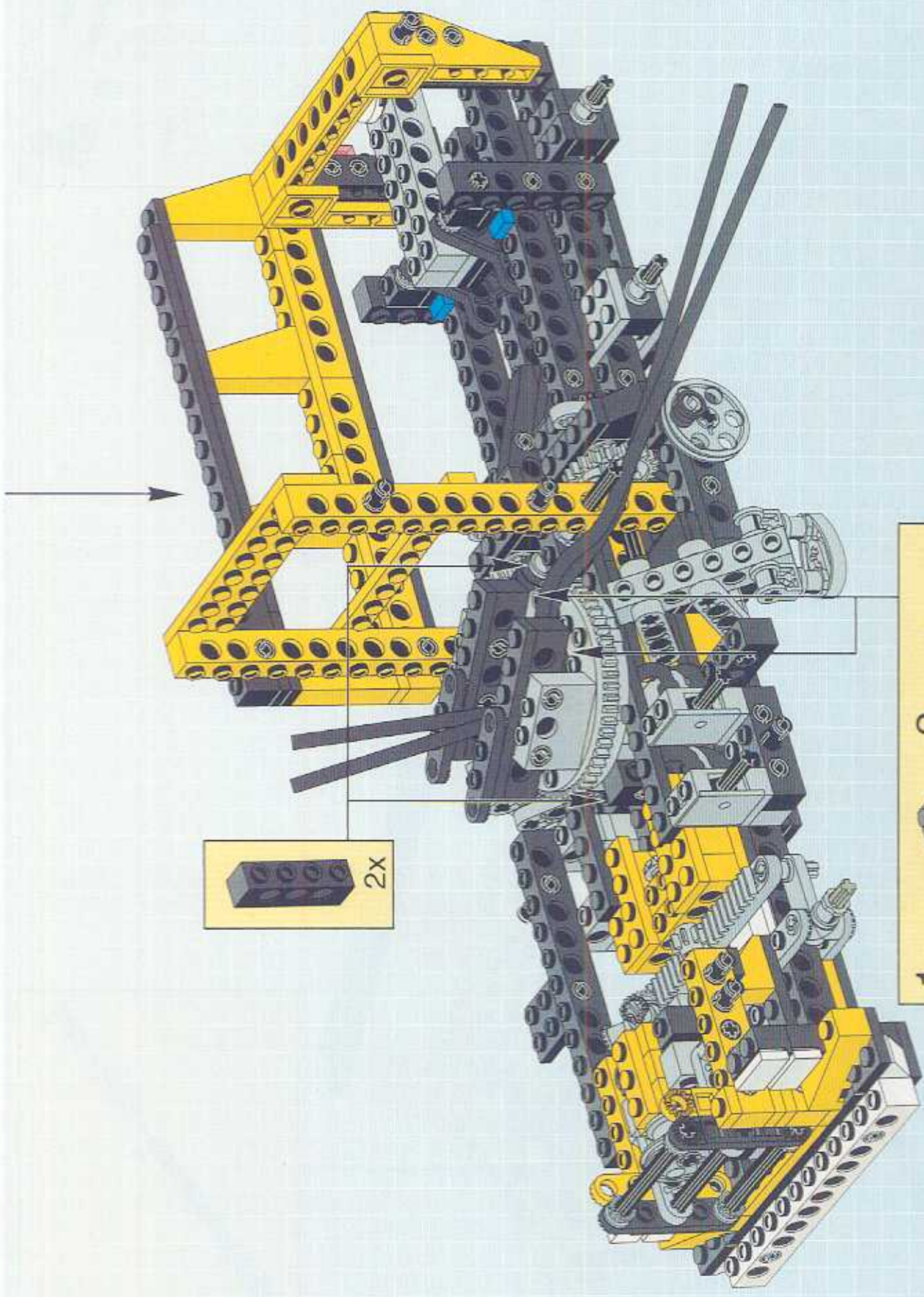

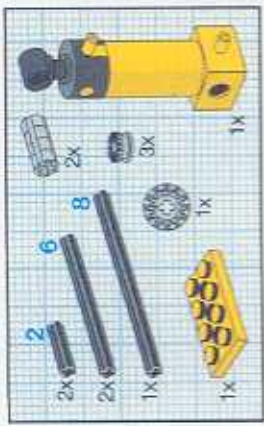
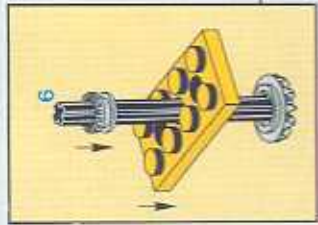
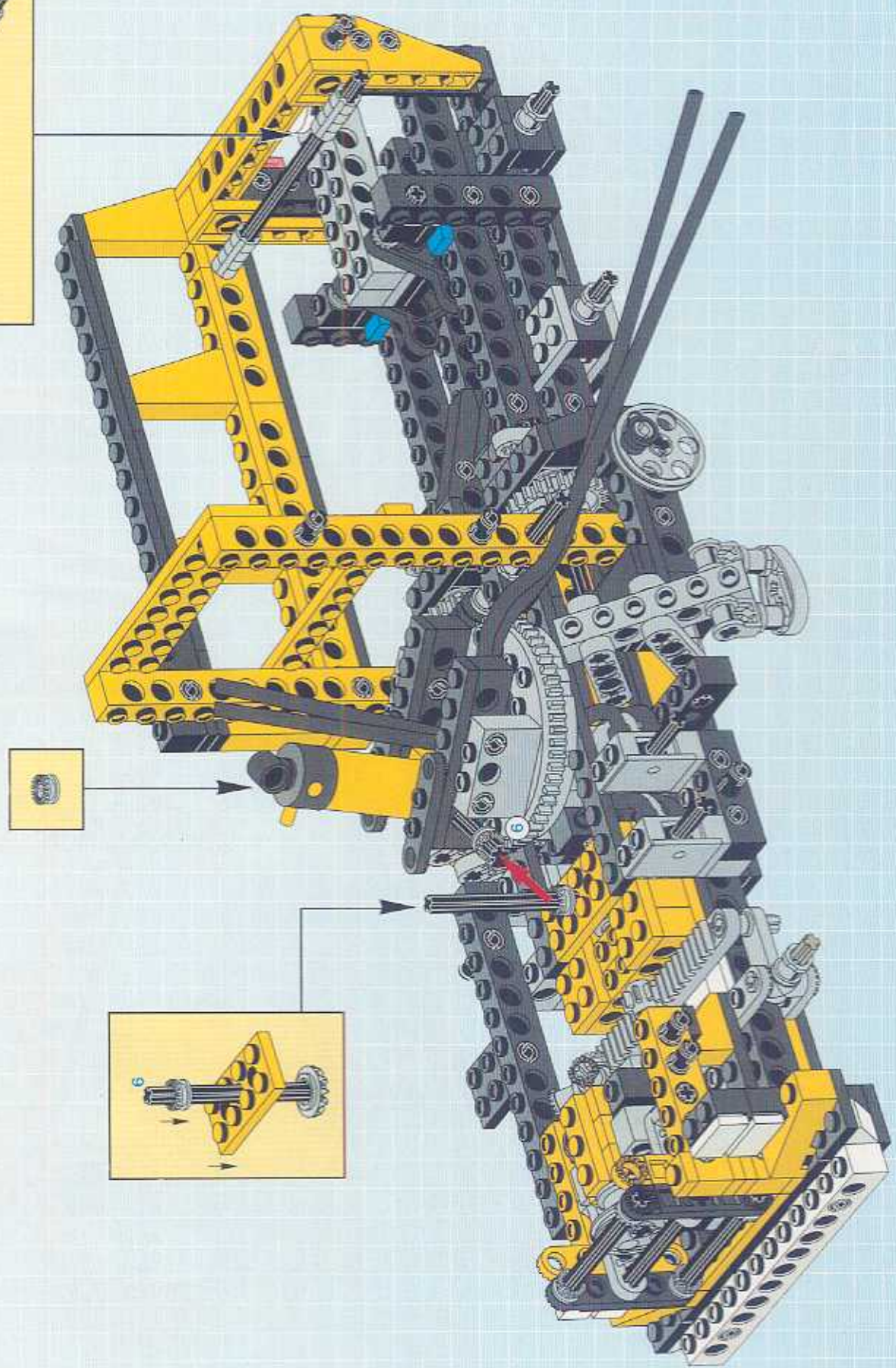
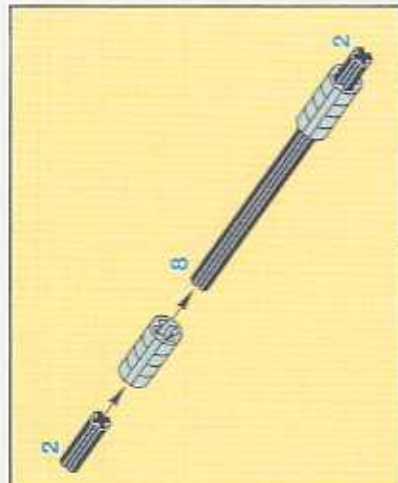

22

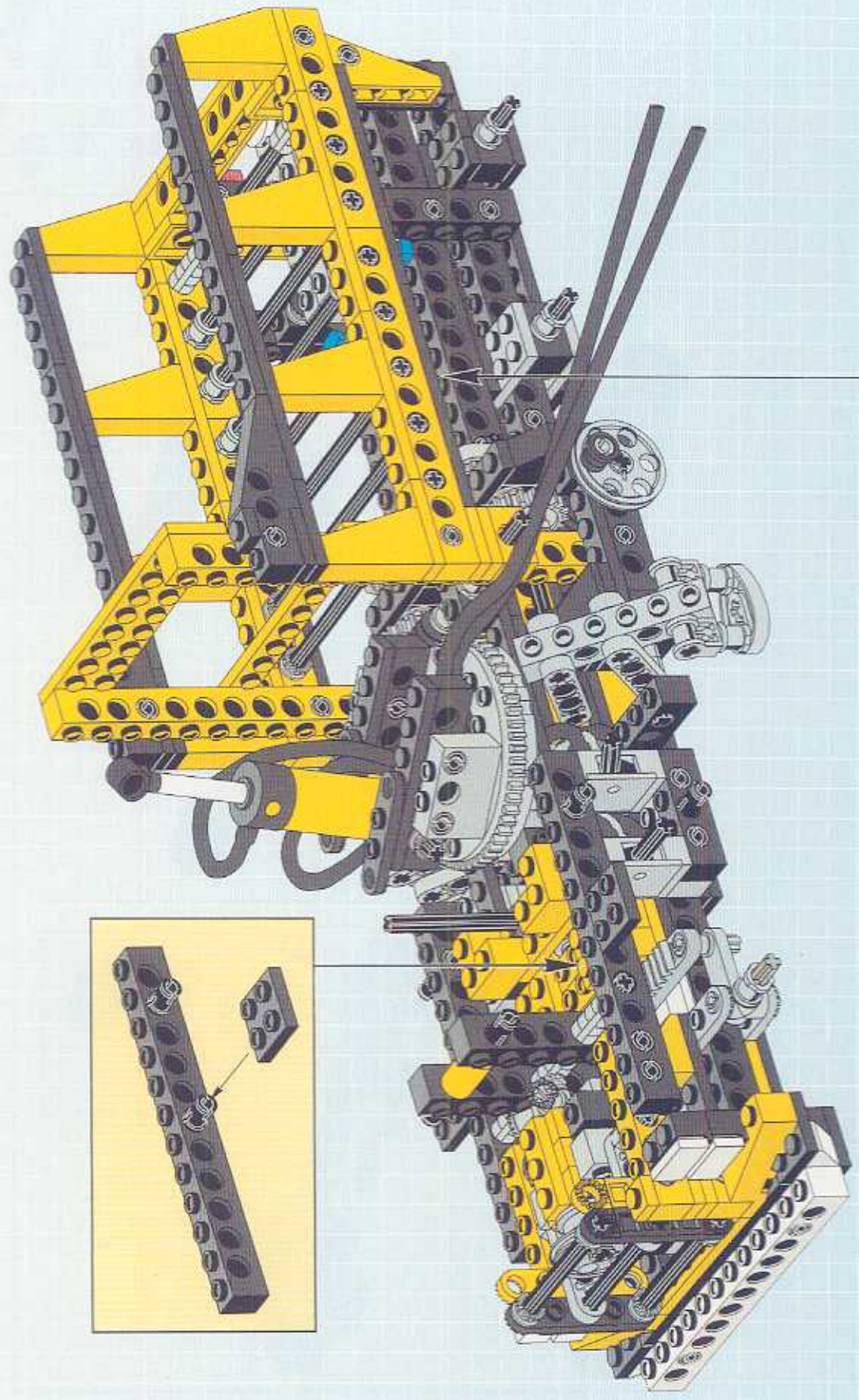

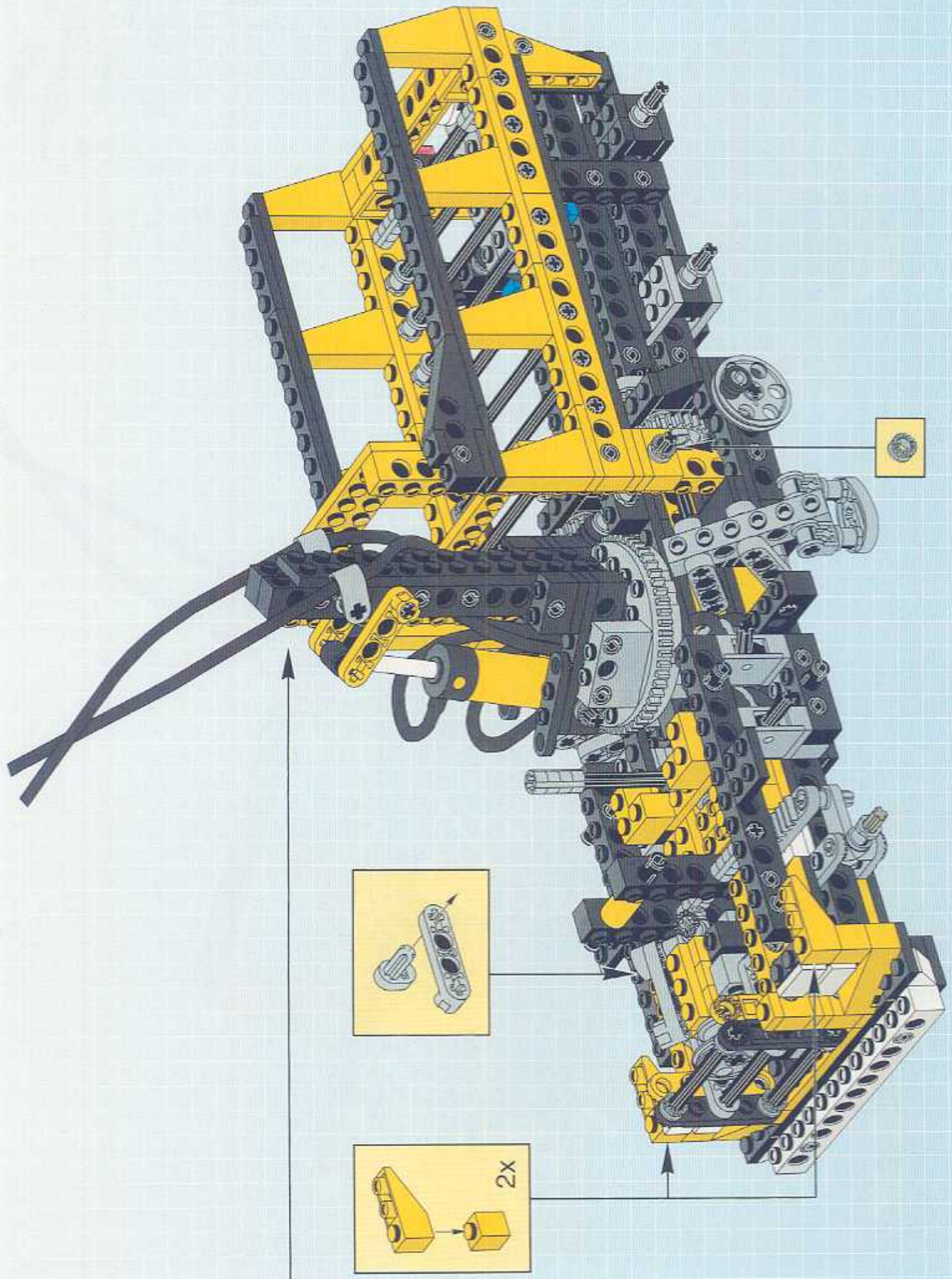

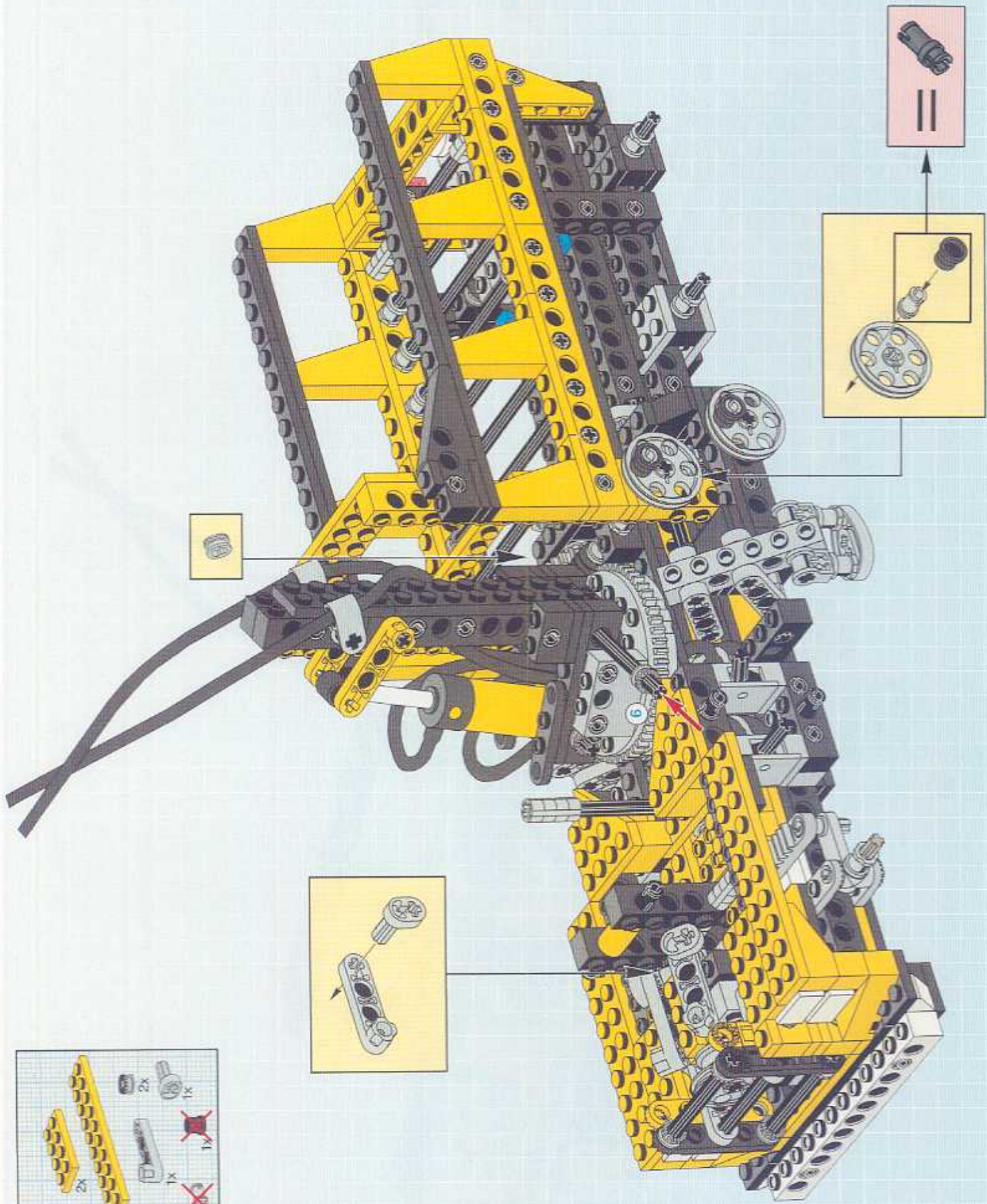

- 1x Yellow 1-hole Technic beam
- 2x Yellow 2-hole Technic beam
- 1x Yellow 3-hole Technic beam
- 1x Grey 1-hole Technic axle
- 2x Grey 2-hole Technic axle
- 1x Grey 3-hole Technic axle
- 1x Grey 1-hole Technic bush
- 1x Grey 2-hole Technic bush
- 1x Grey 3-hole Technic bush
- 1x Grey 1-hole Technic pin
- 1x Grey 2-hole Technic pin
- 1x Grey 3-hole Technic pin
- 1x Grey 1-hole Technic stop
- 1x Grey 2-hole Technic stop
- 1x Grey 3-hole Technic stop
- 1x Grey 1-hole Technic spacer
- 1x Grey 2-hole Technic spacer
- 1x Grey 3-hole Technic spacer

26

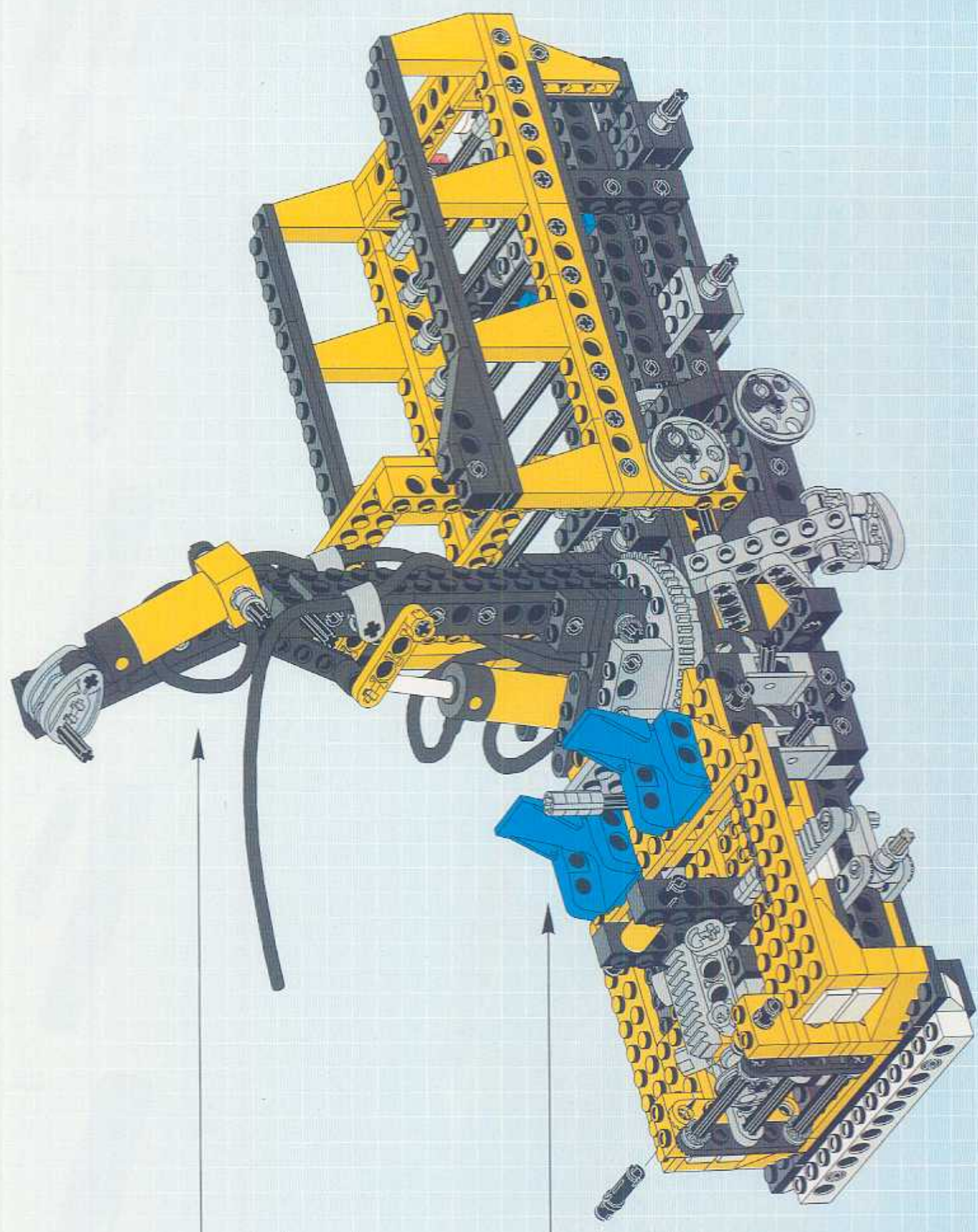

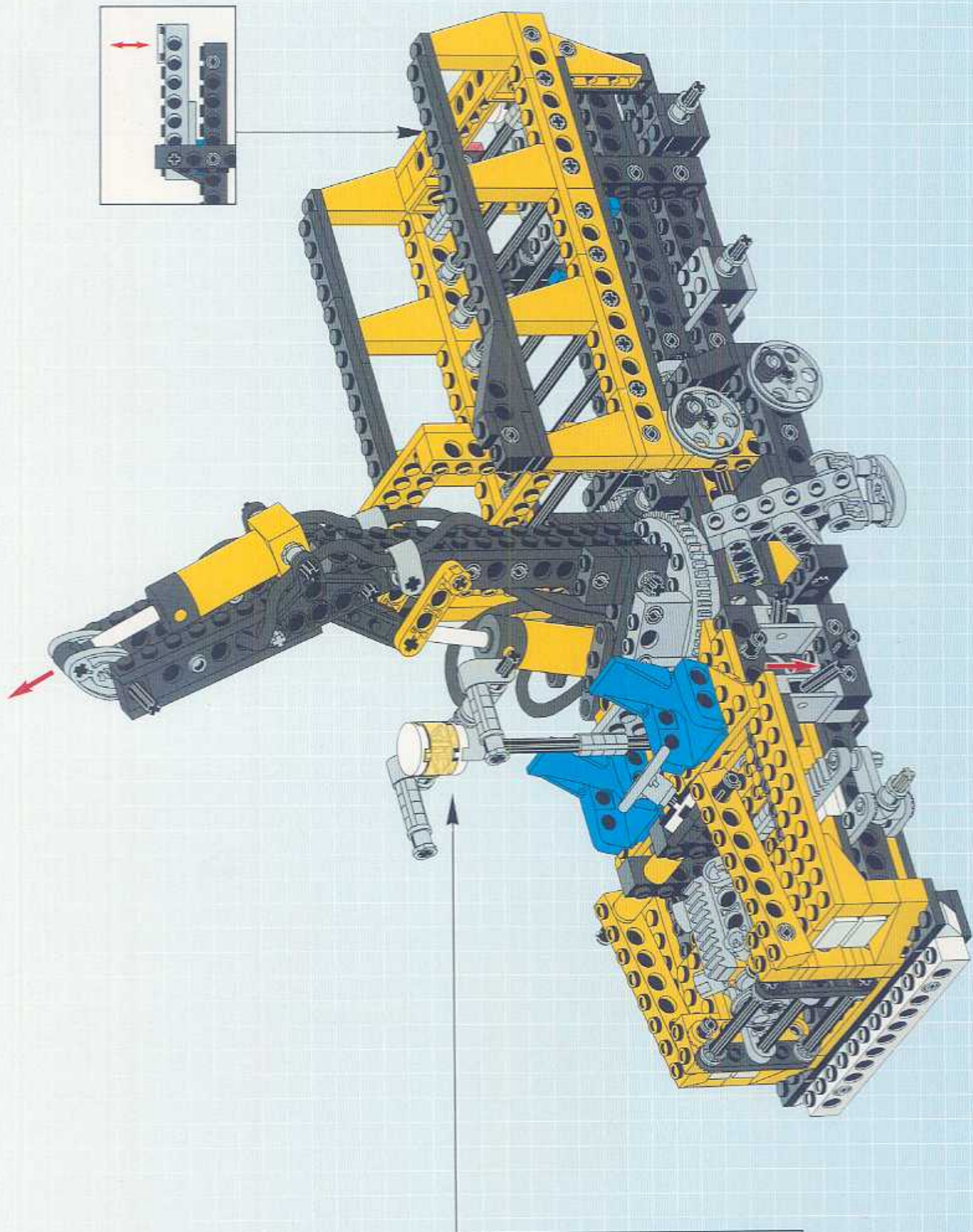

31

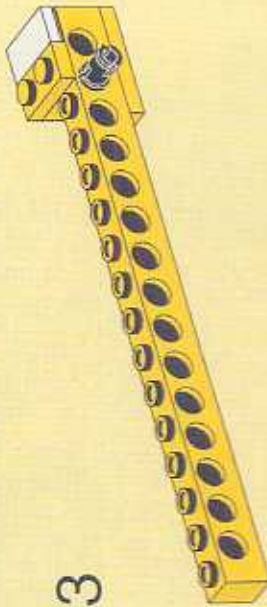
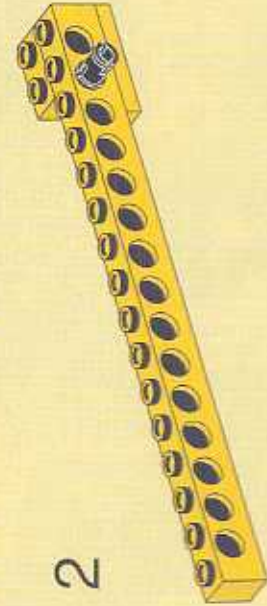
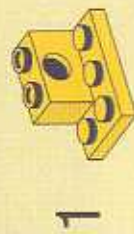
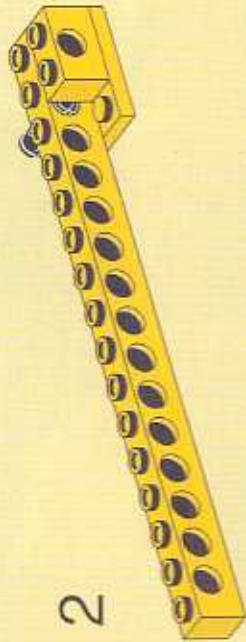
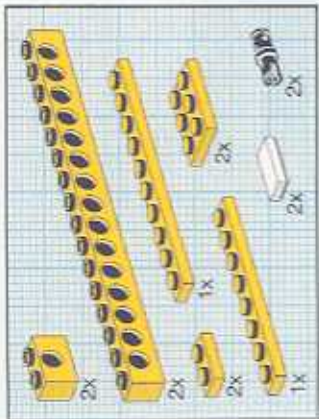

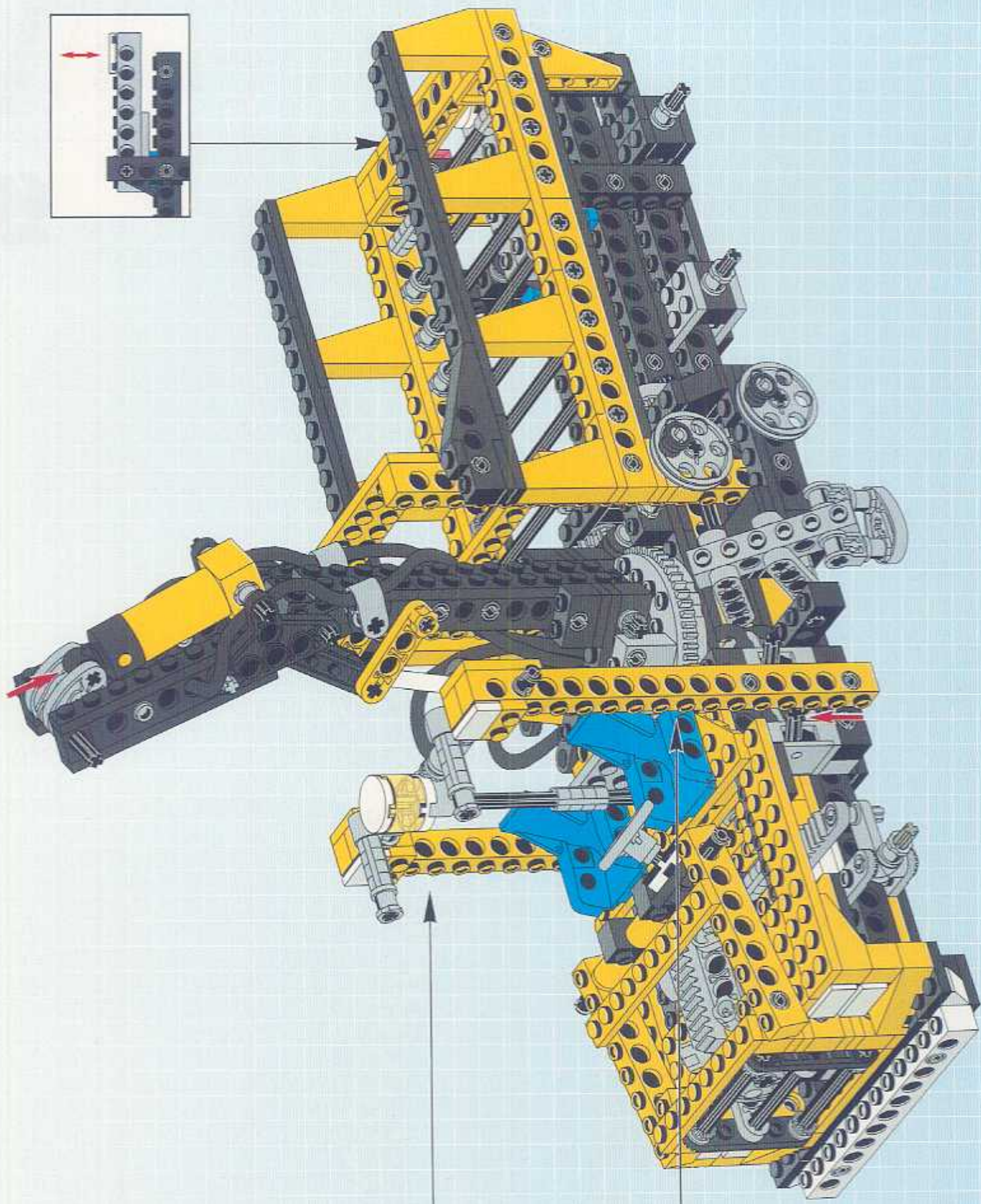

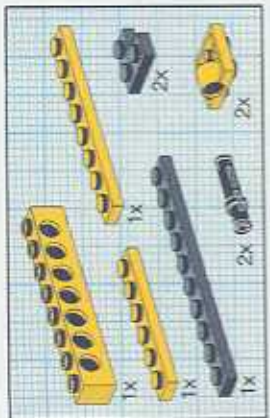
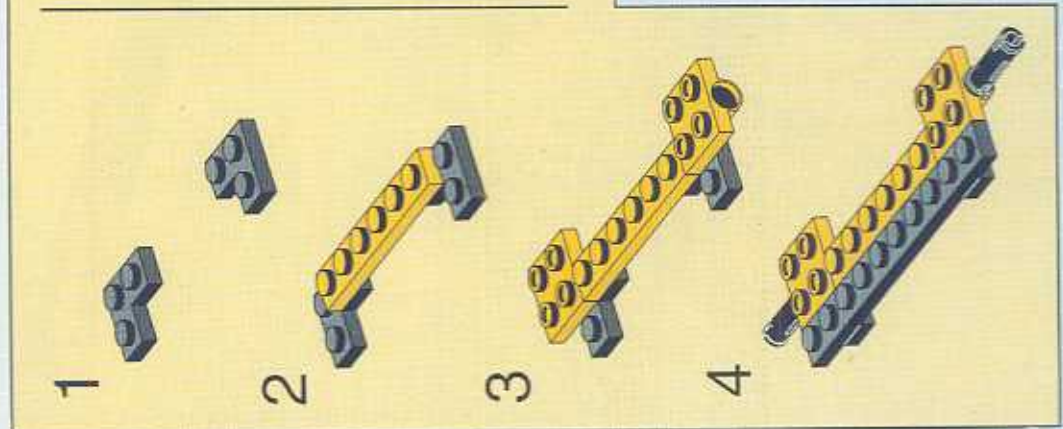
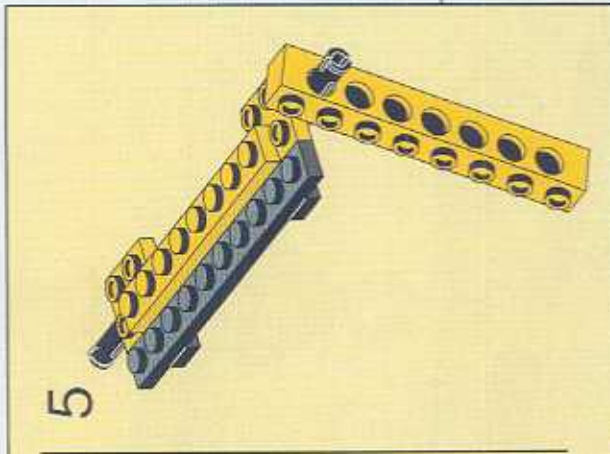
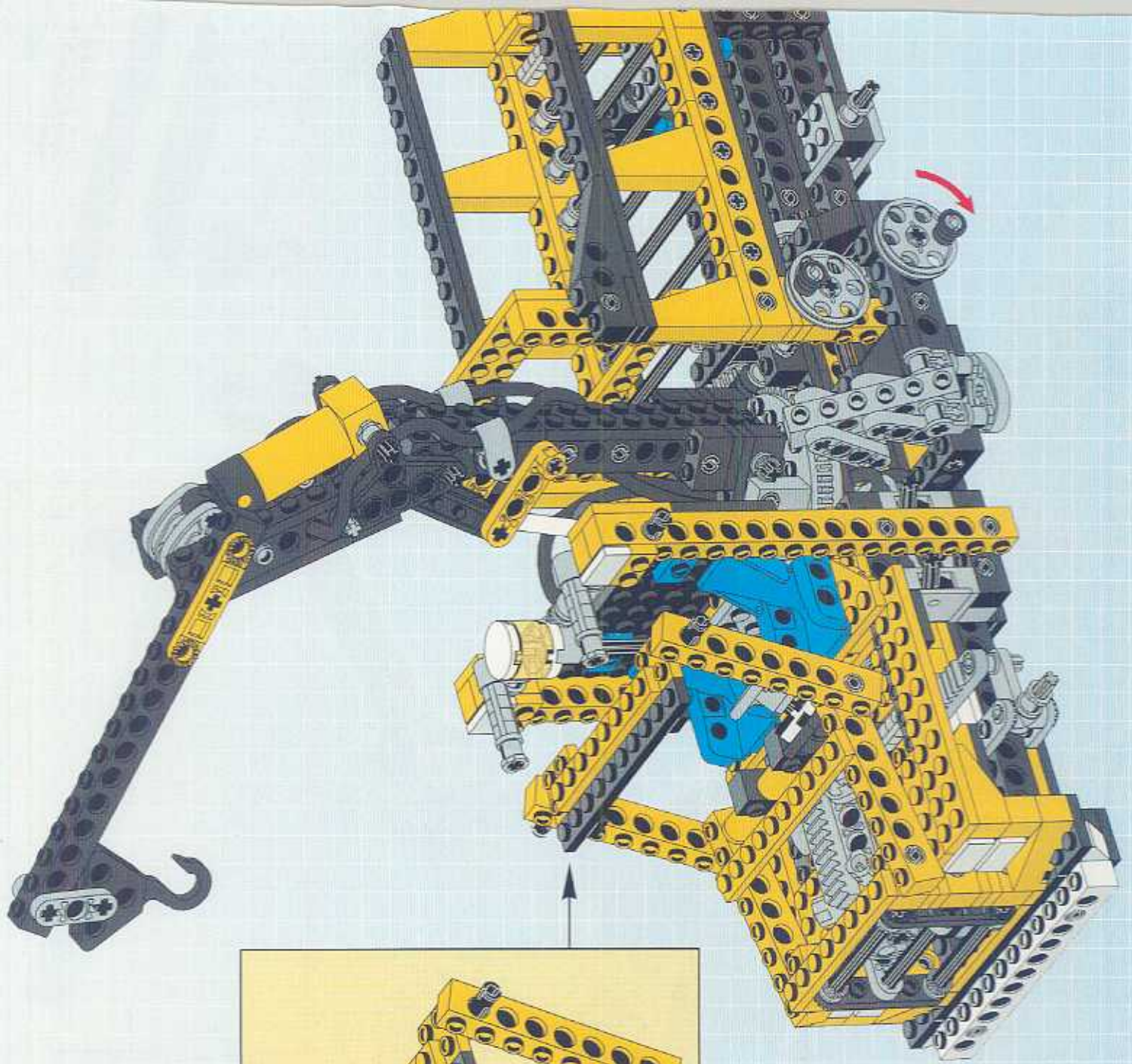

33

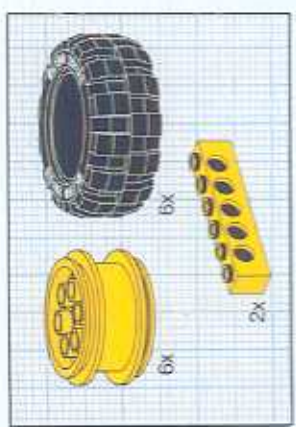
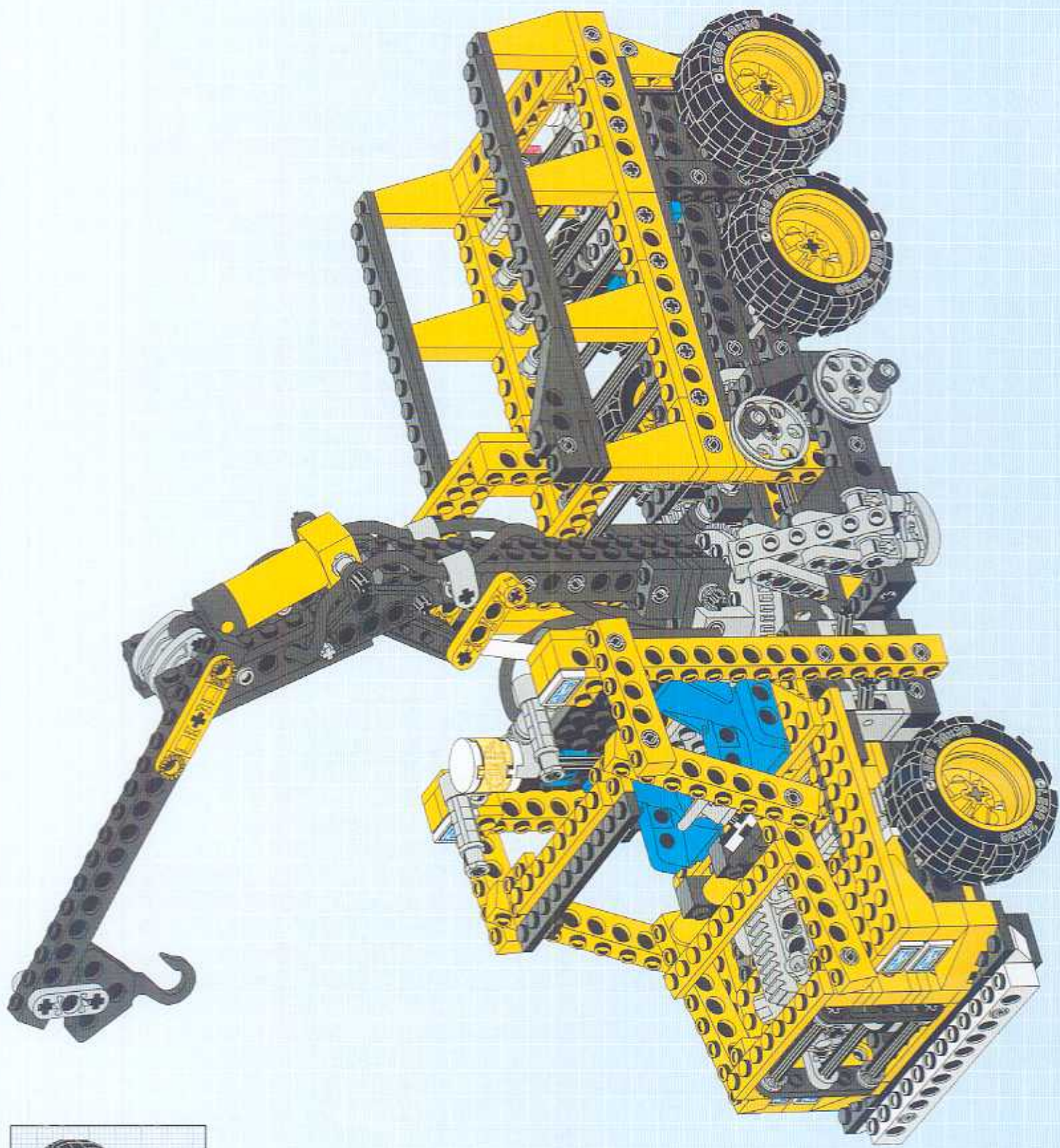

34

