



# STAR WARS



9525





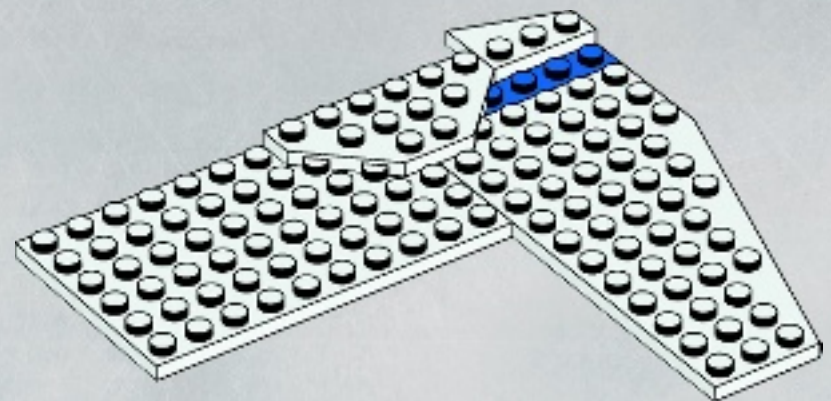
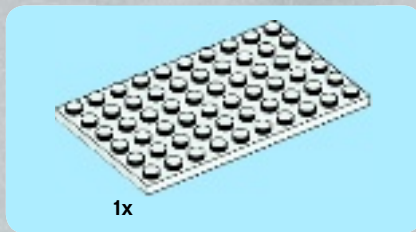
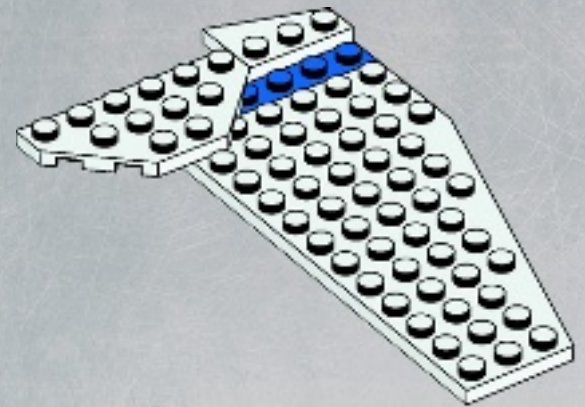
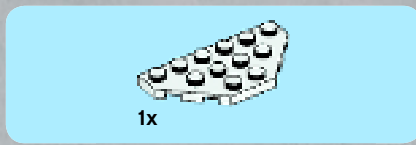
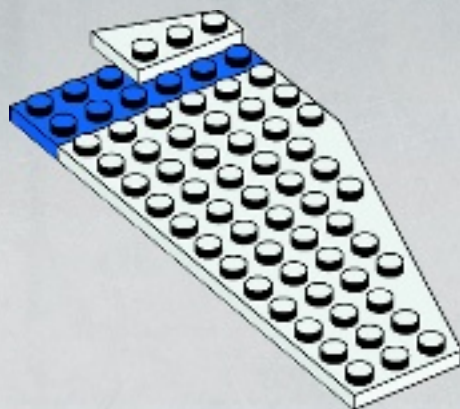
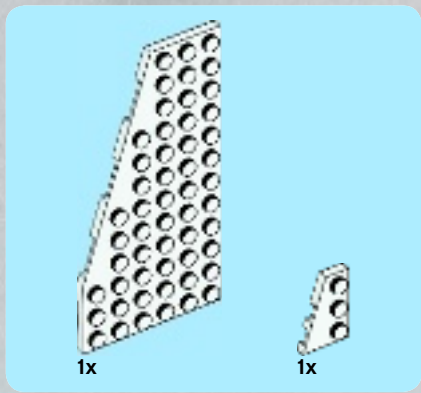
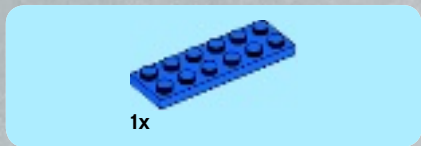
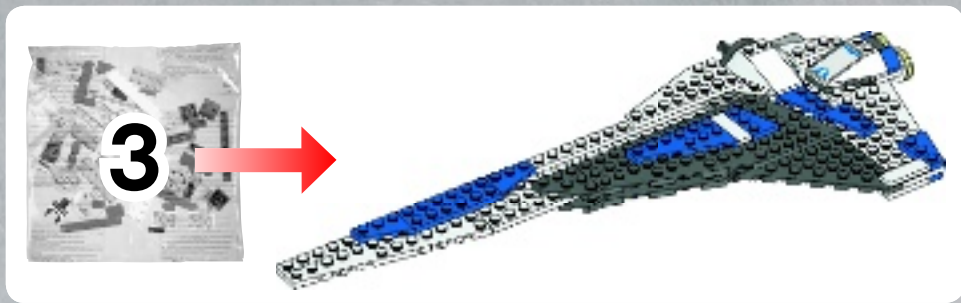

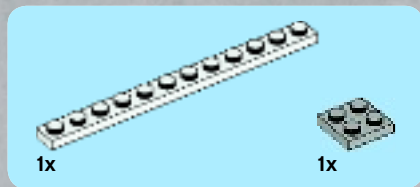

5

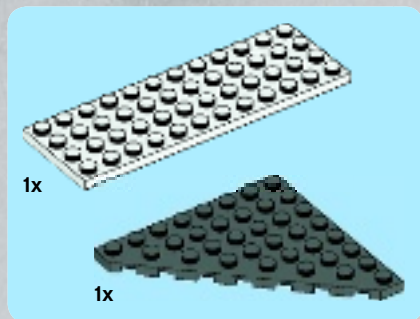
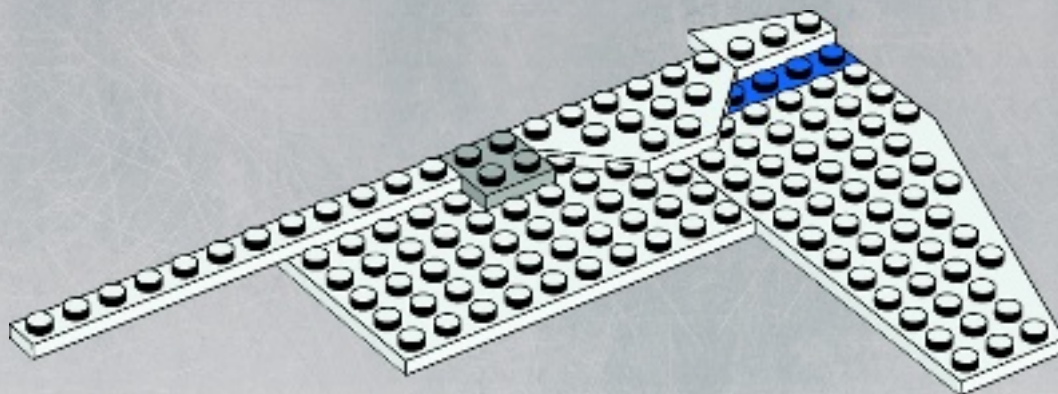

6

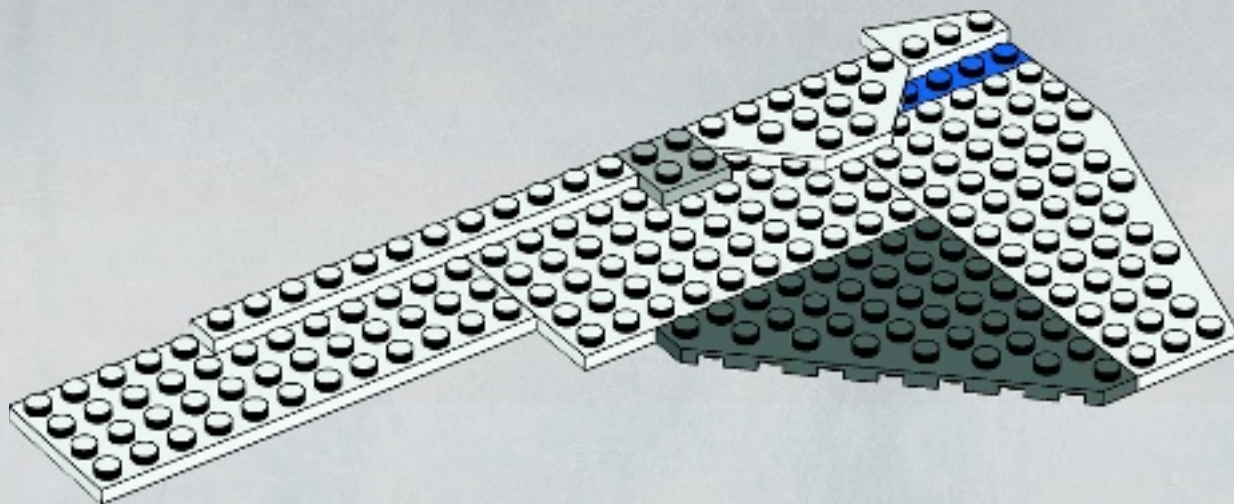



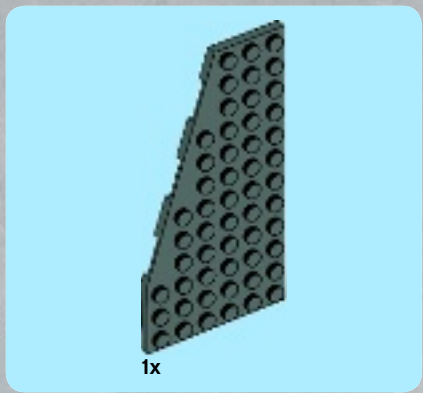

7

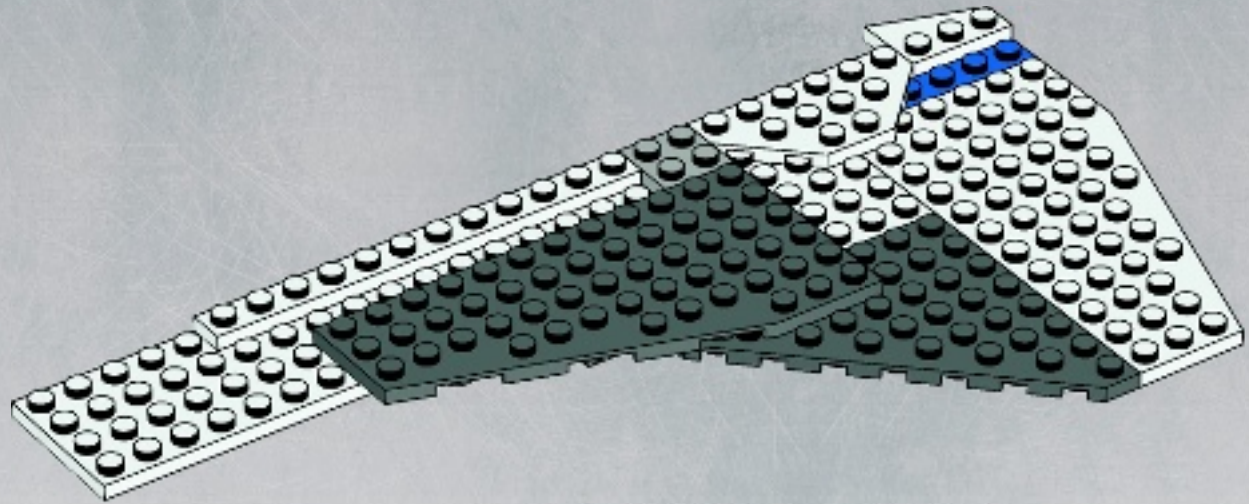

8

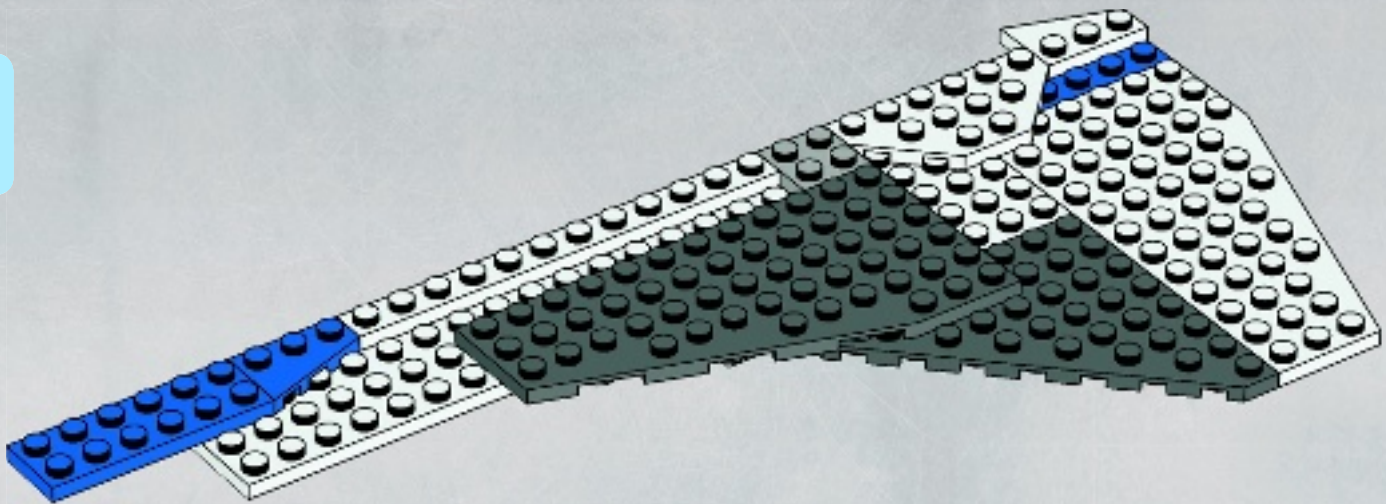



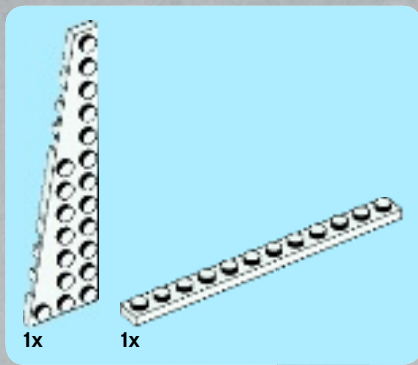

9

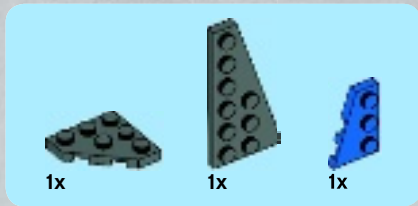
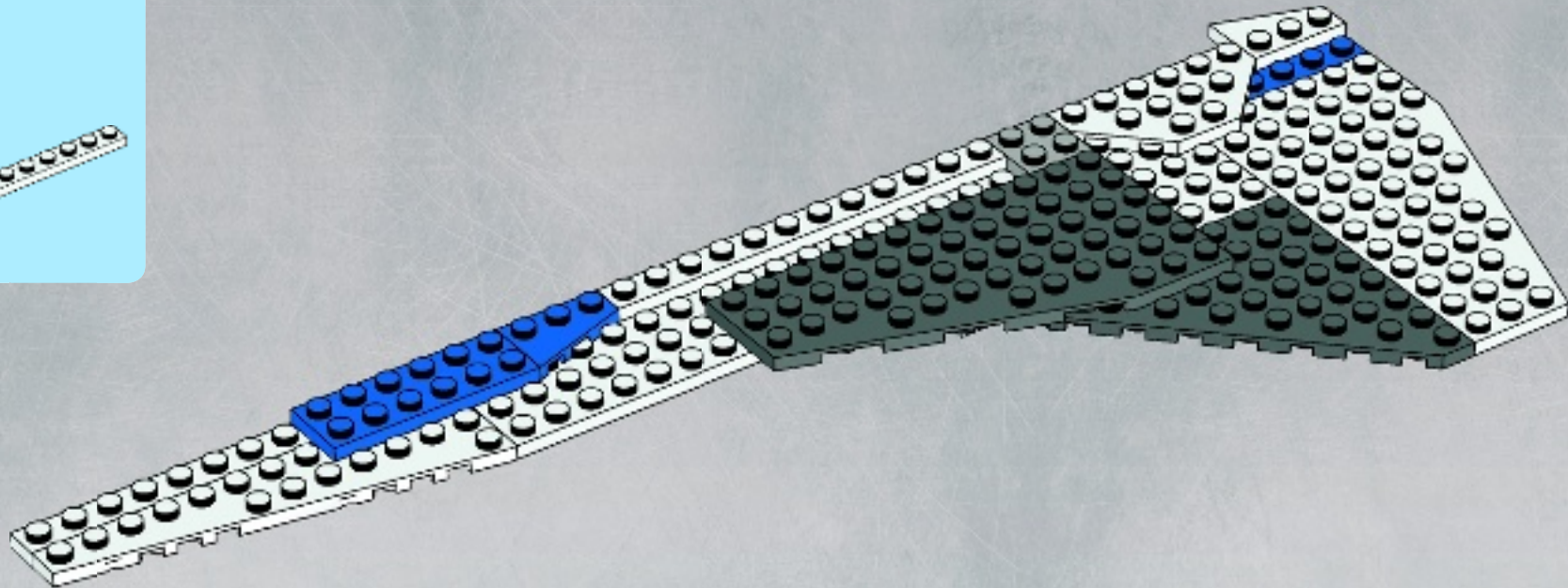

10

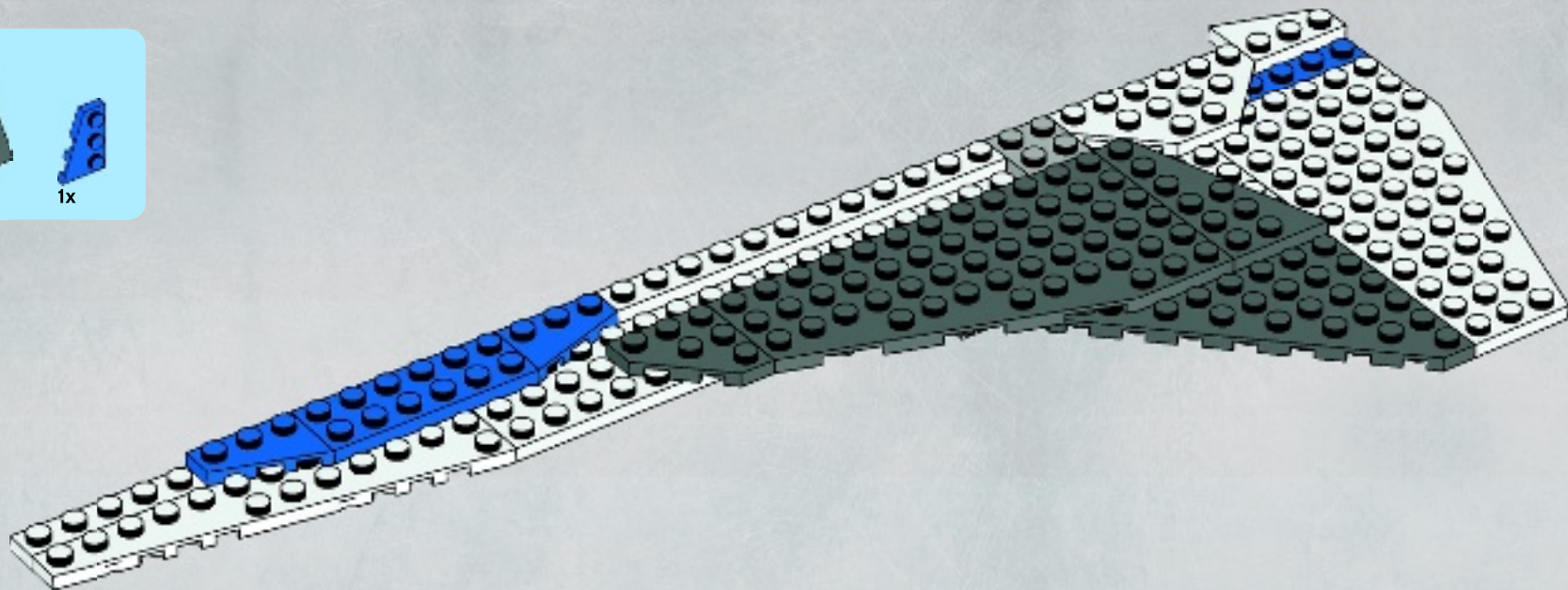



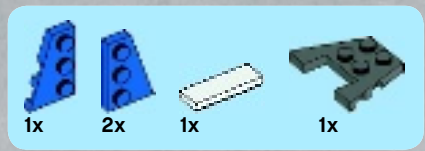

11

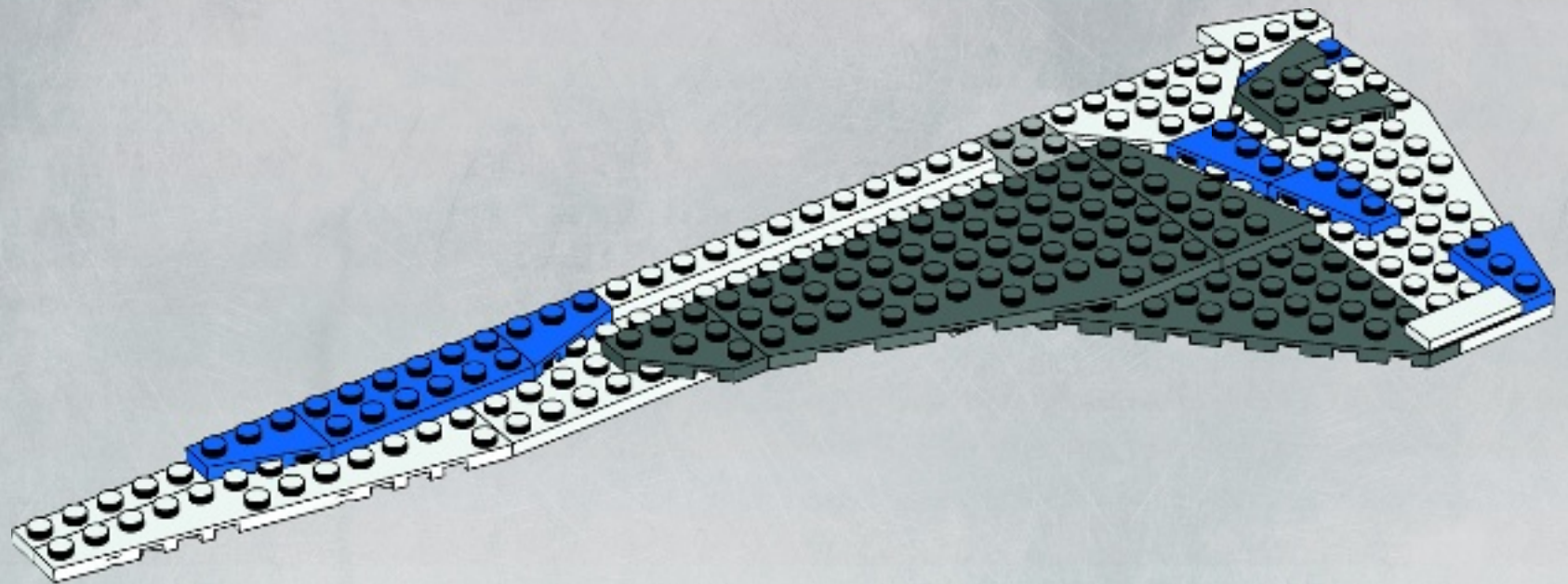



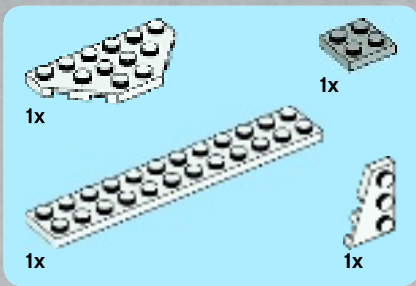

12

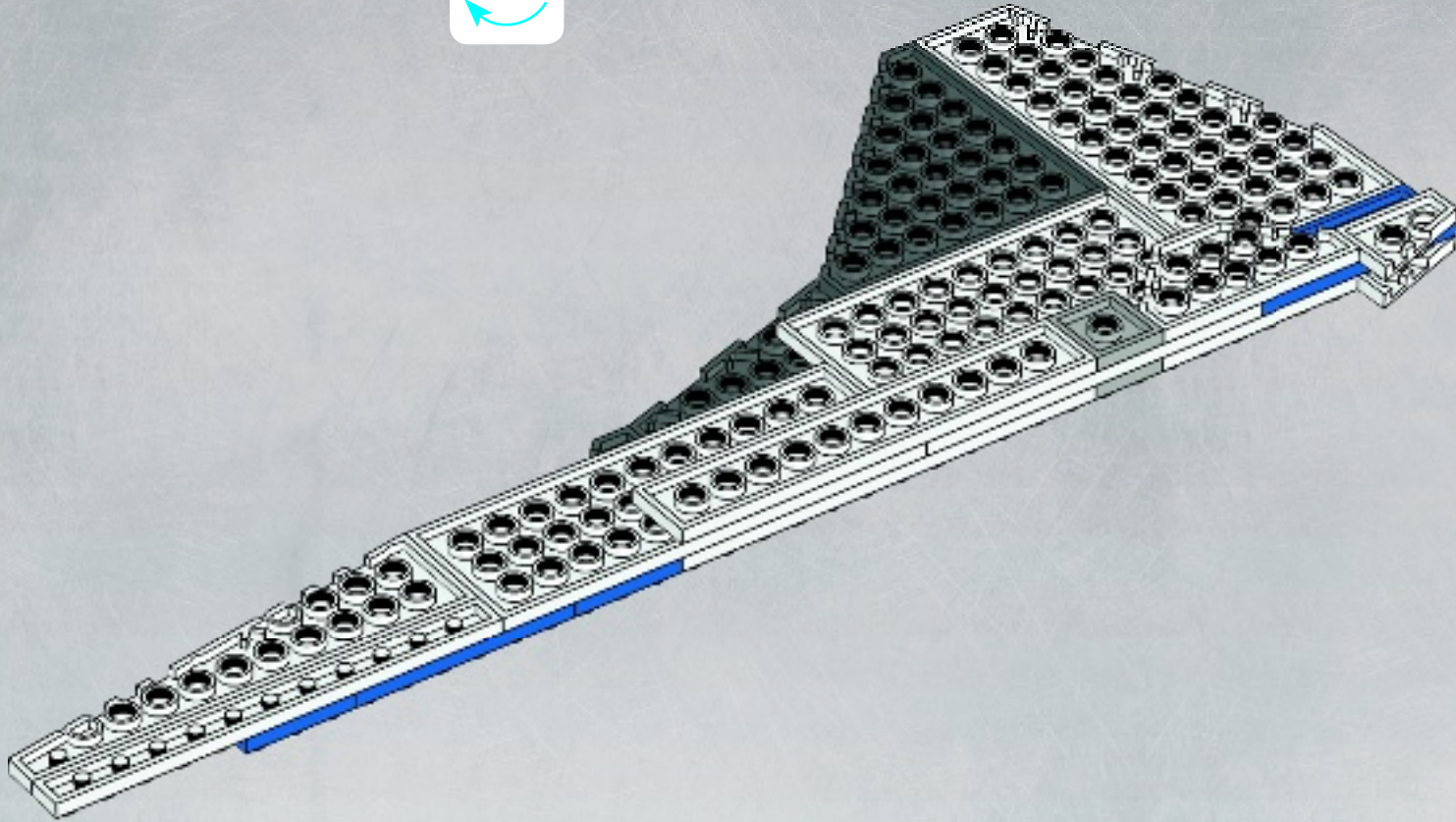



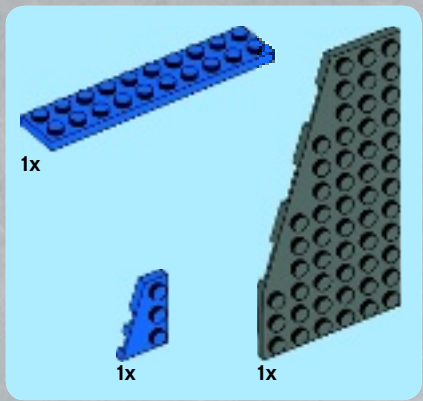

13

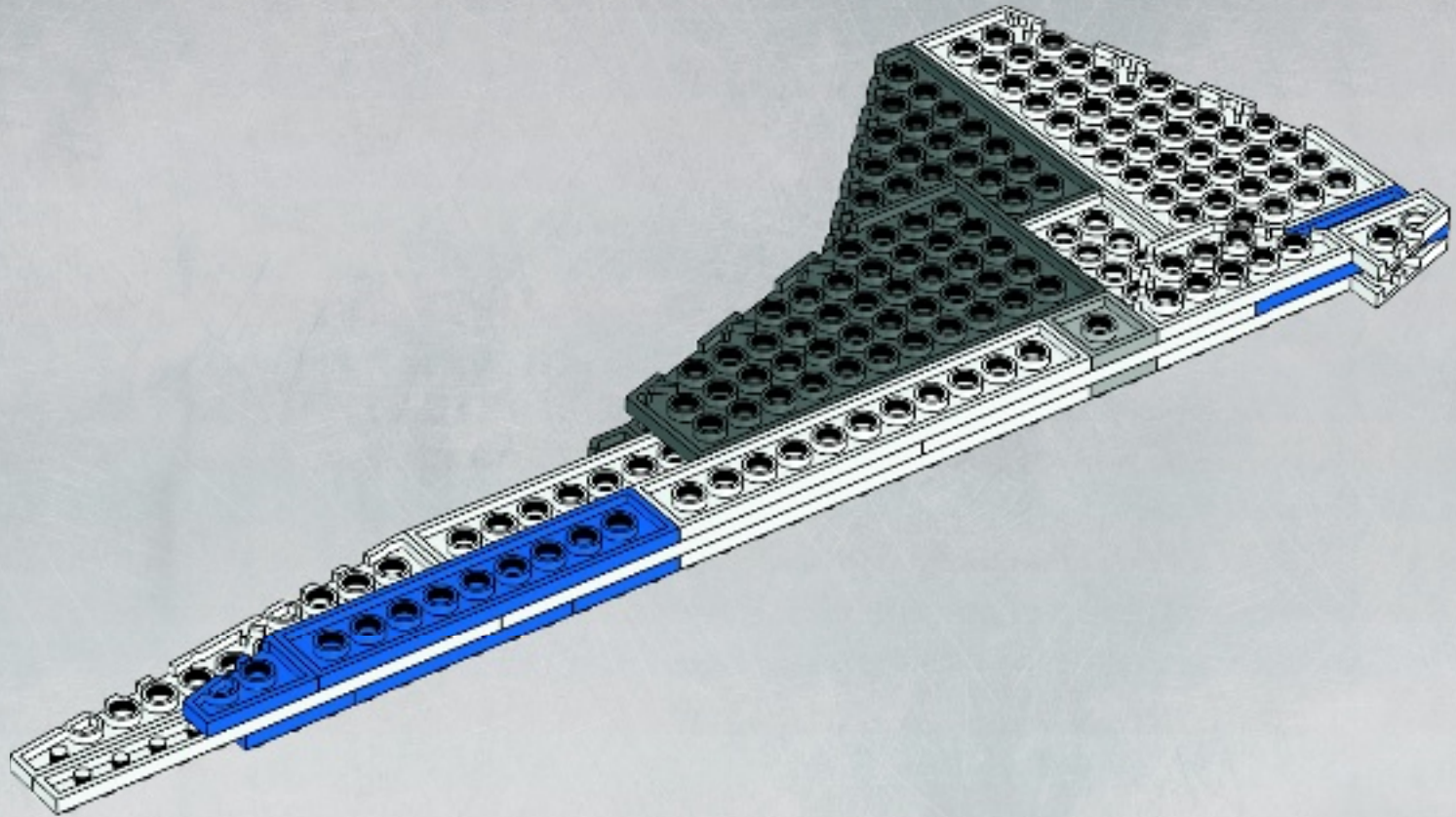



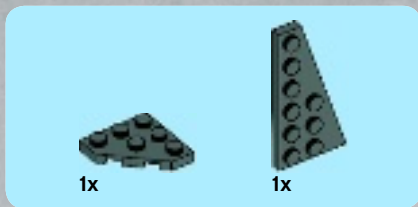

14

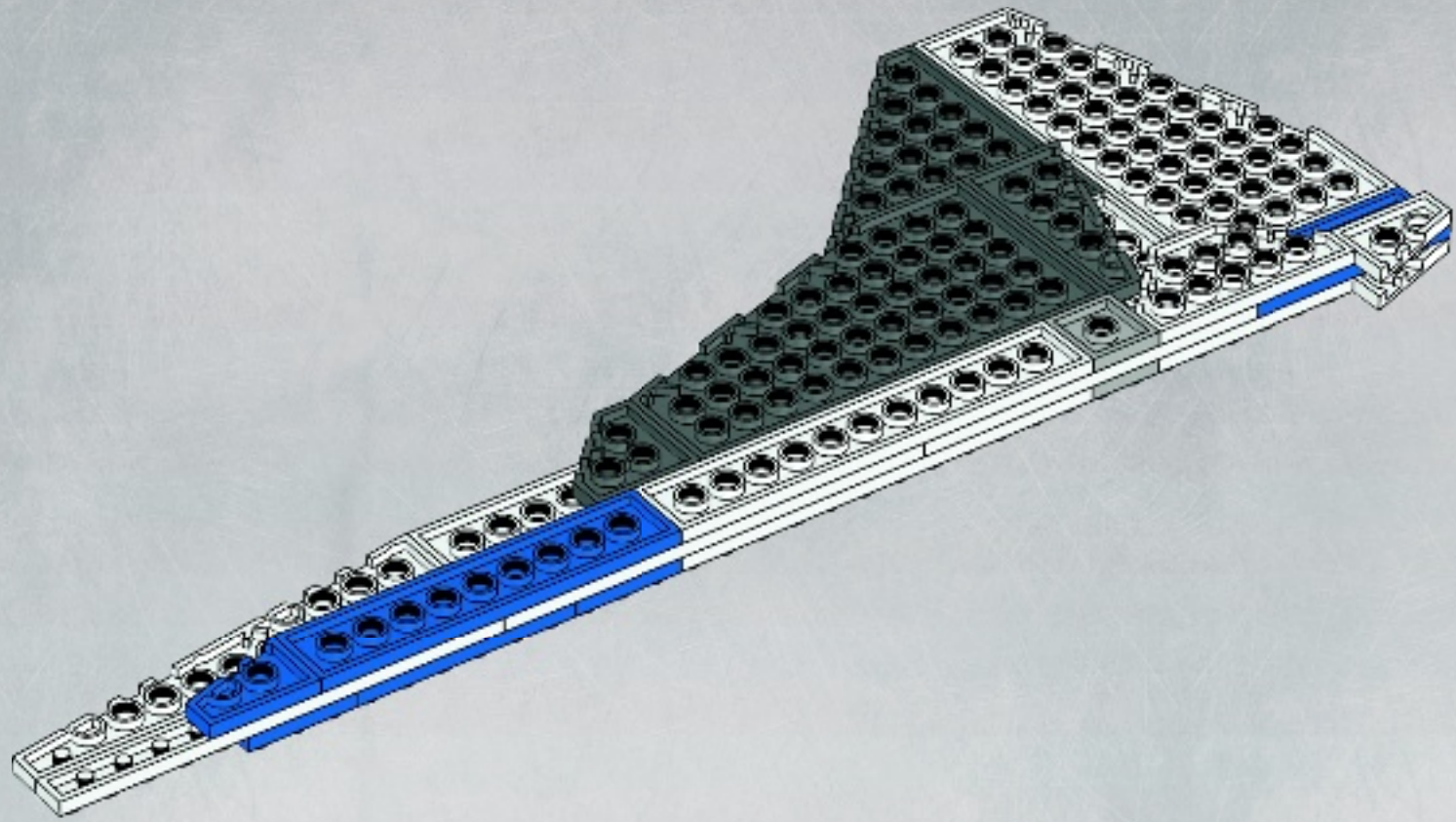





15

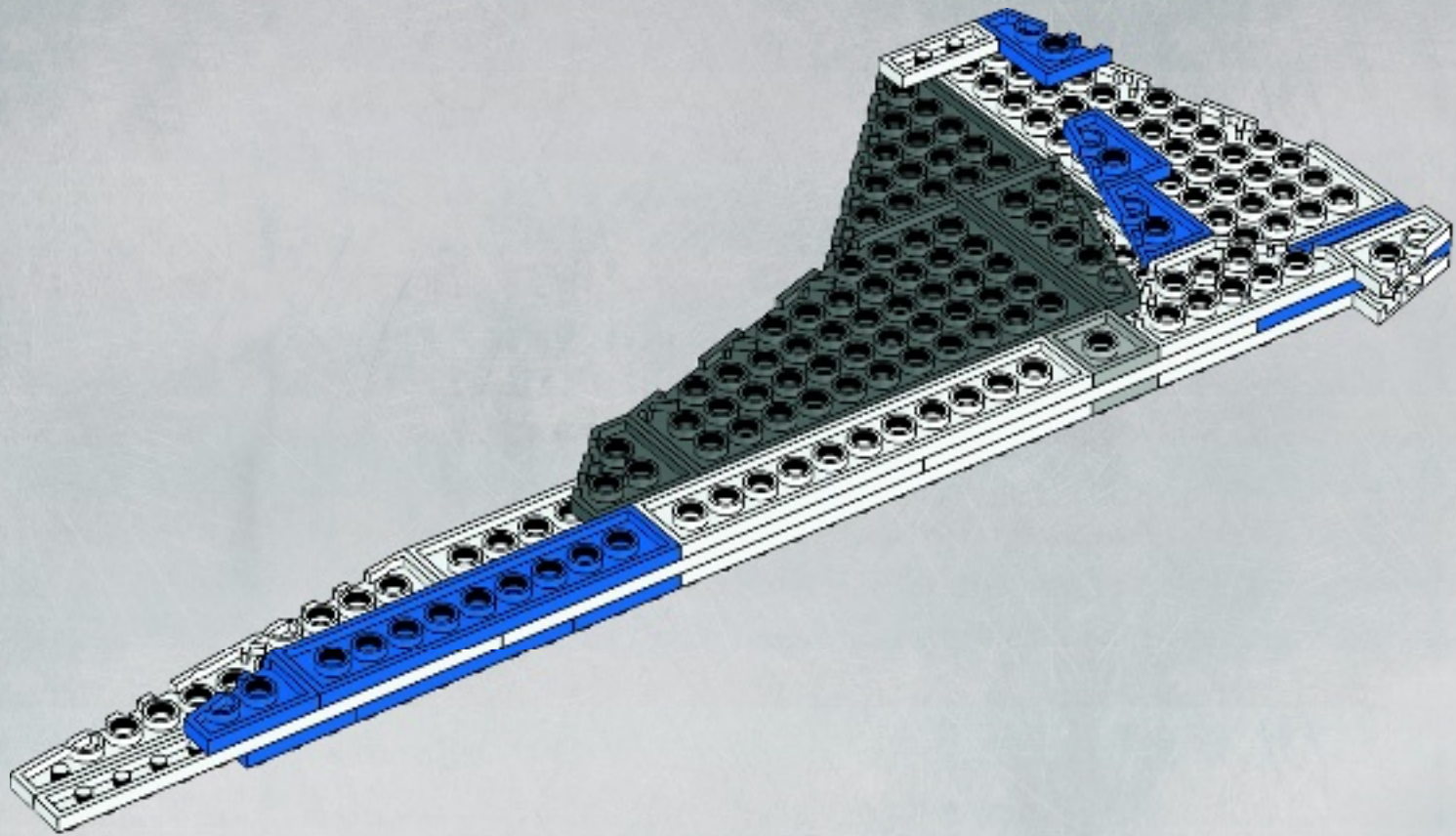





16

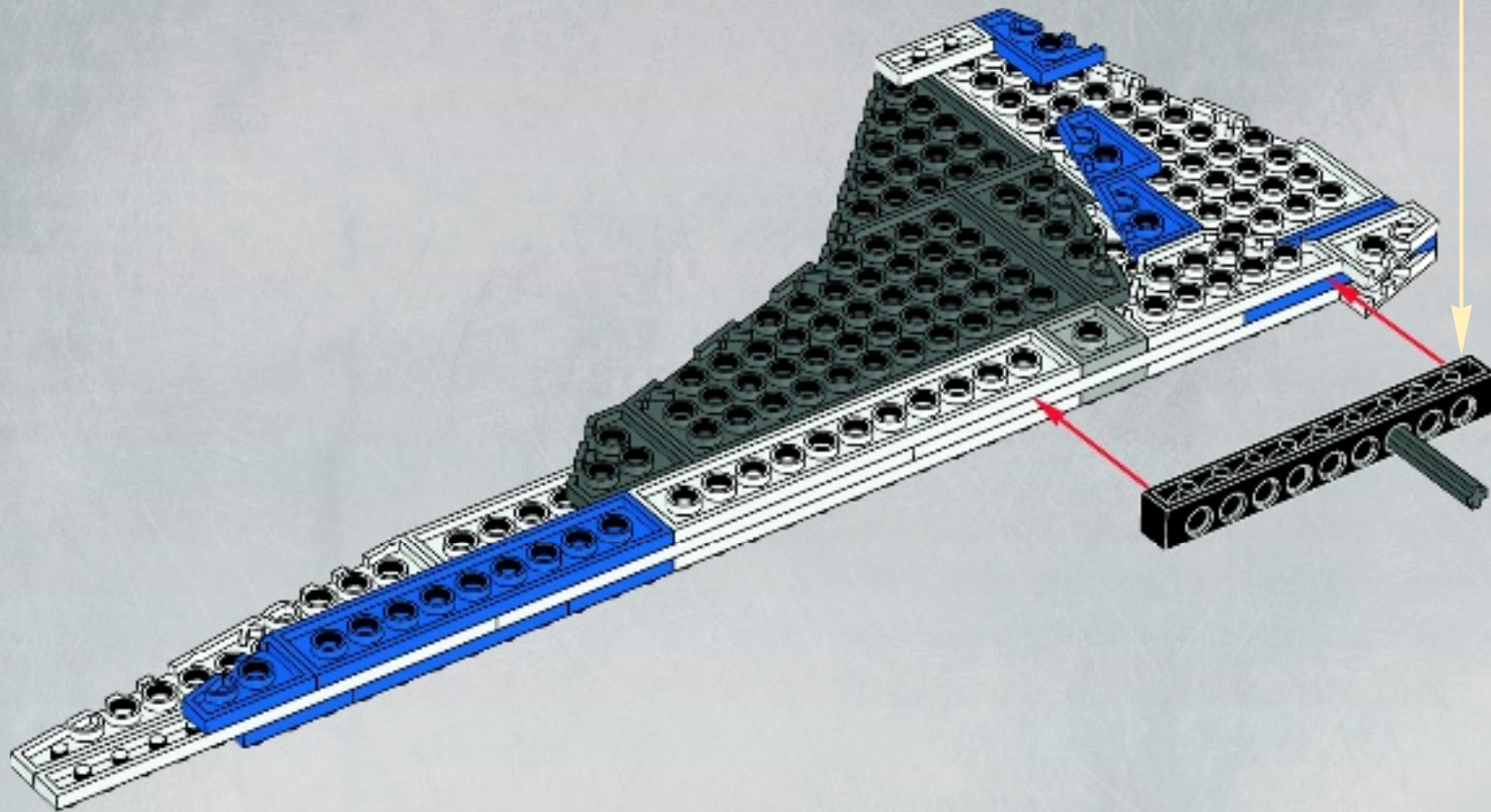
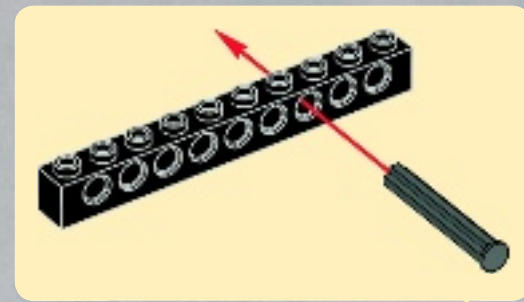





1x



1x

17

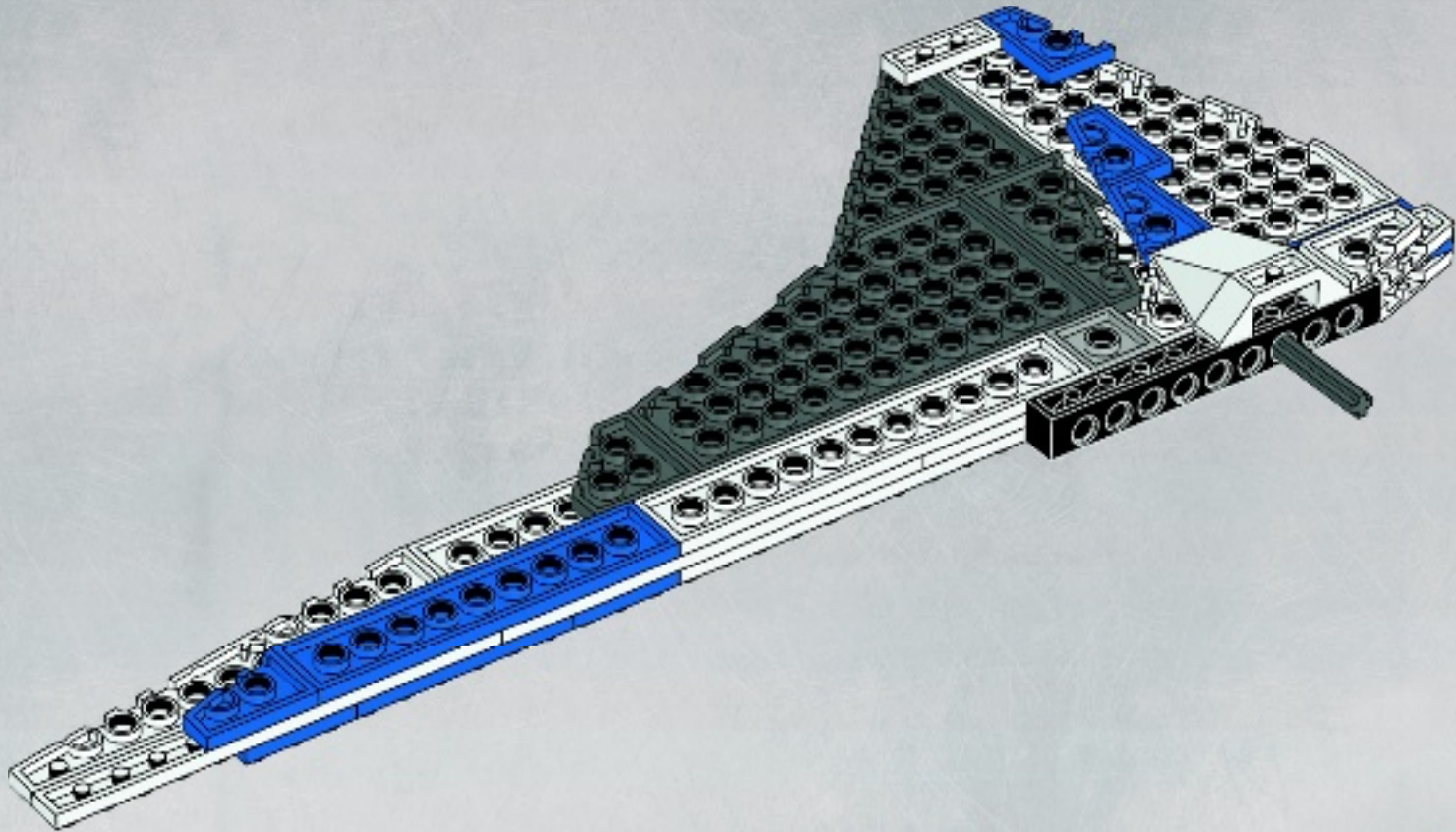

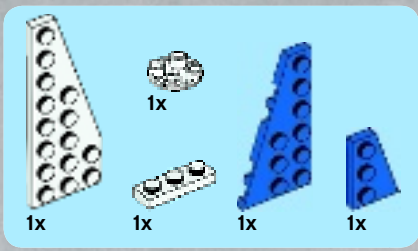

18

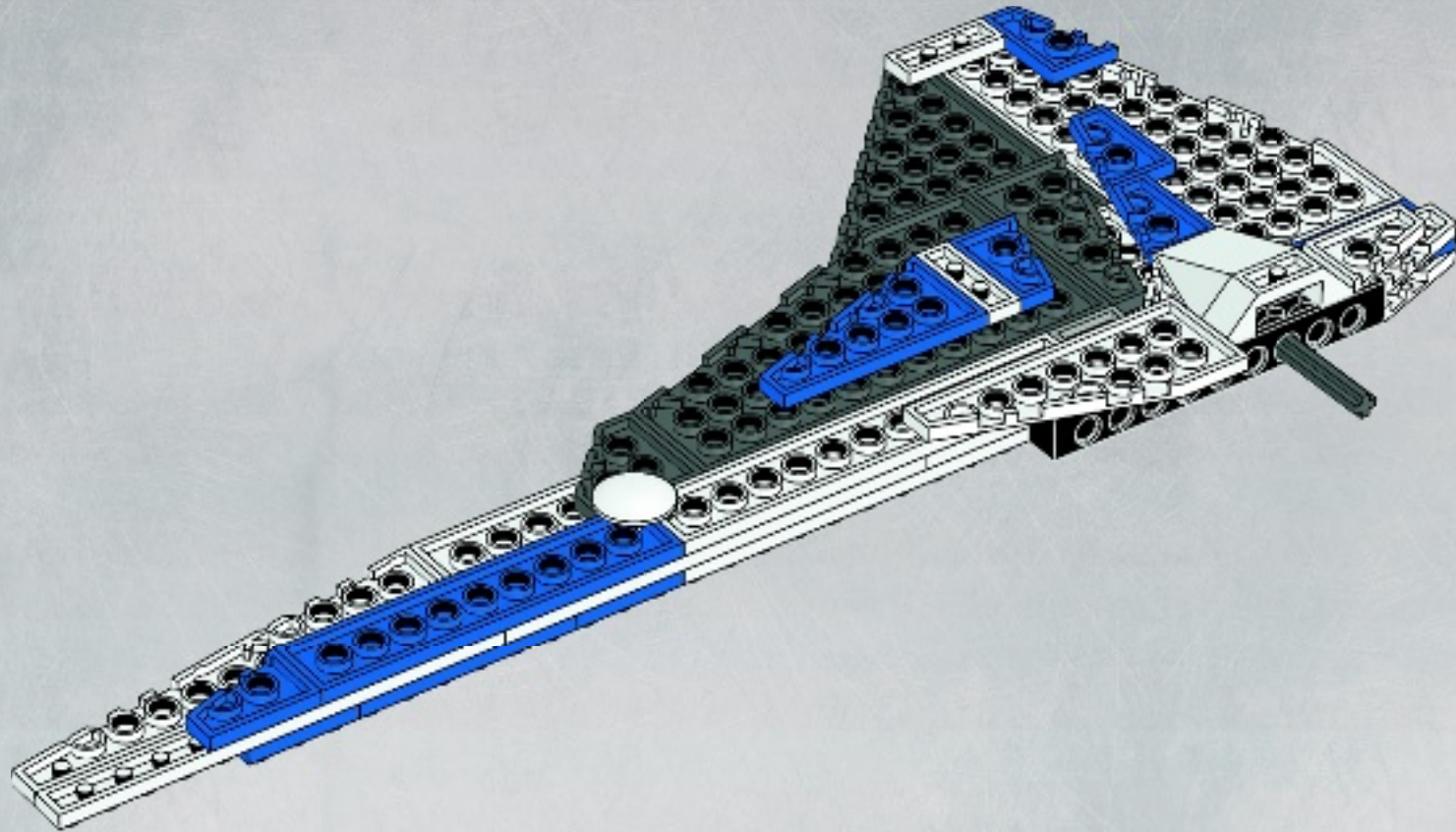





19

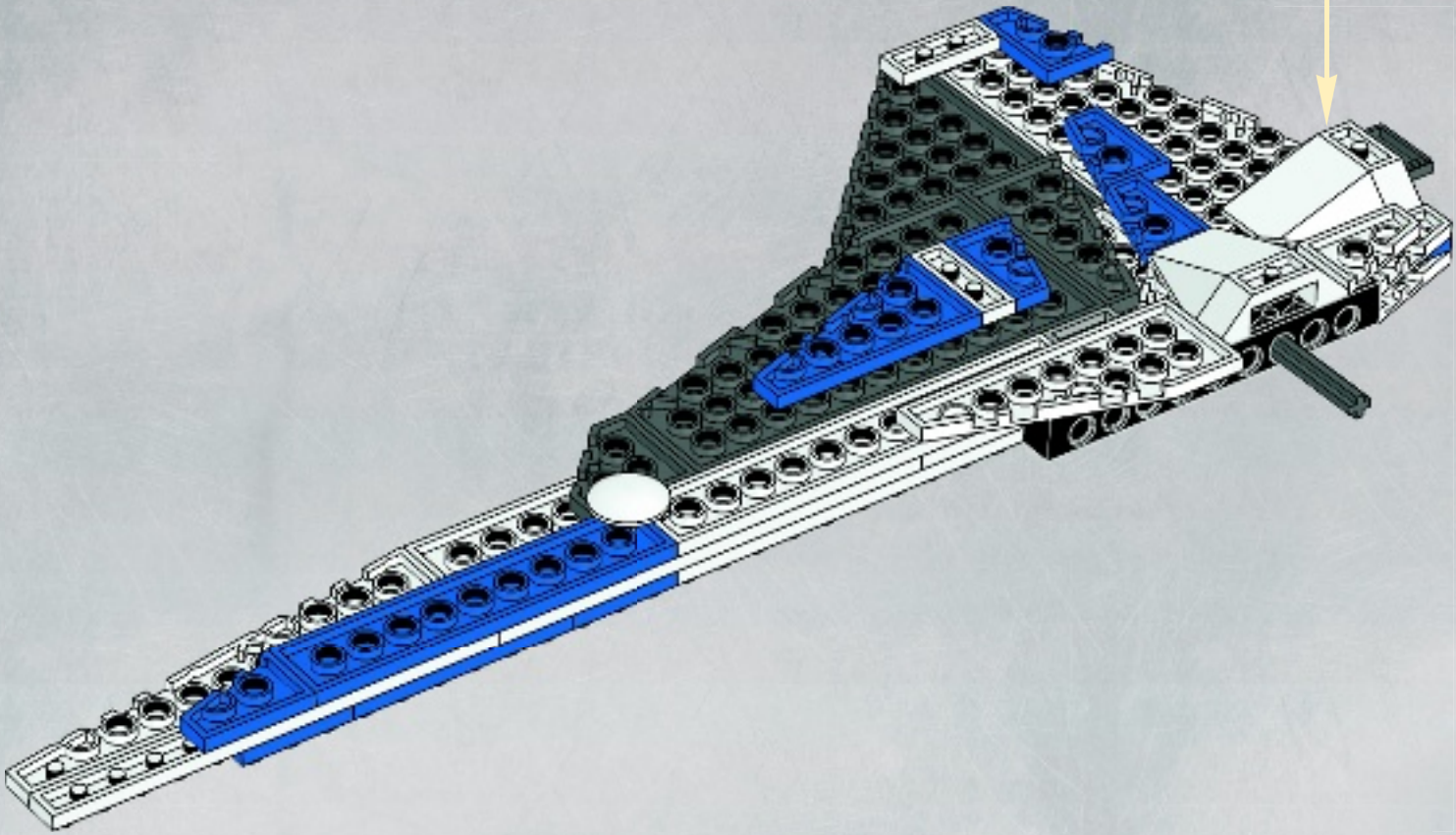
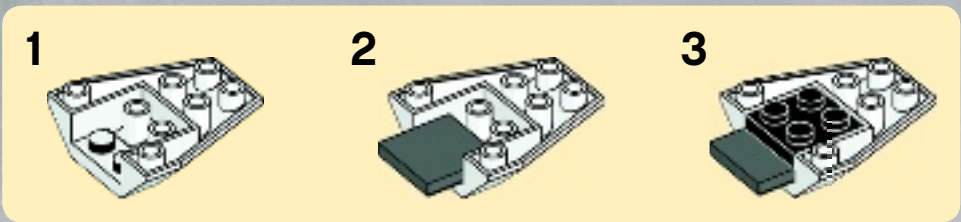

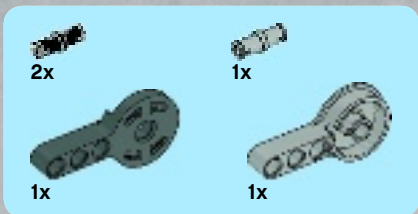

20

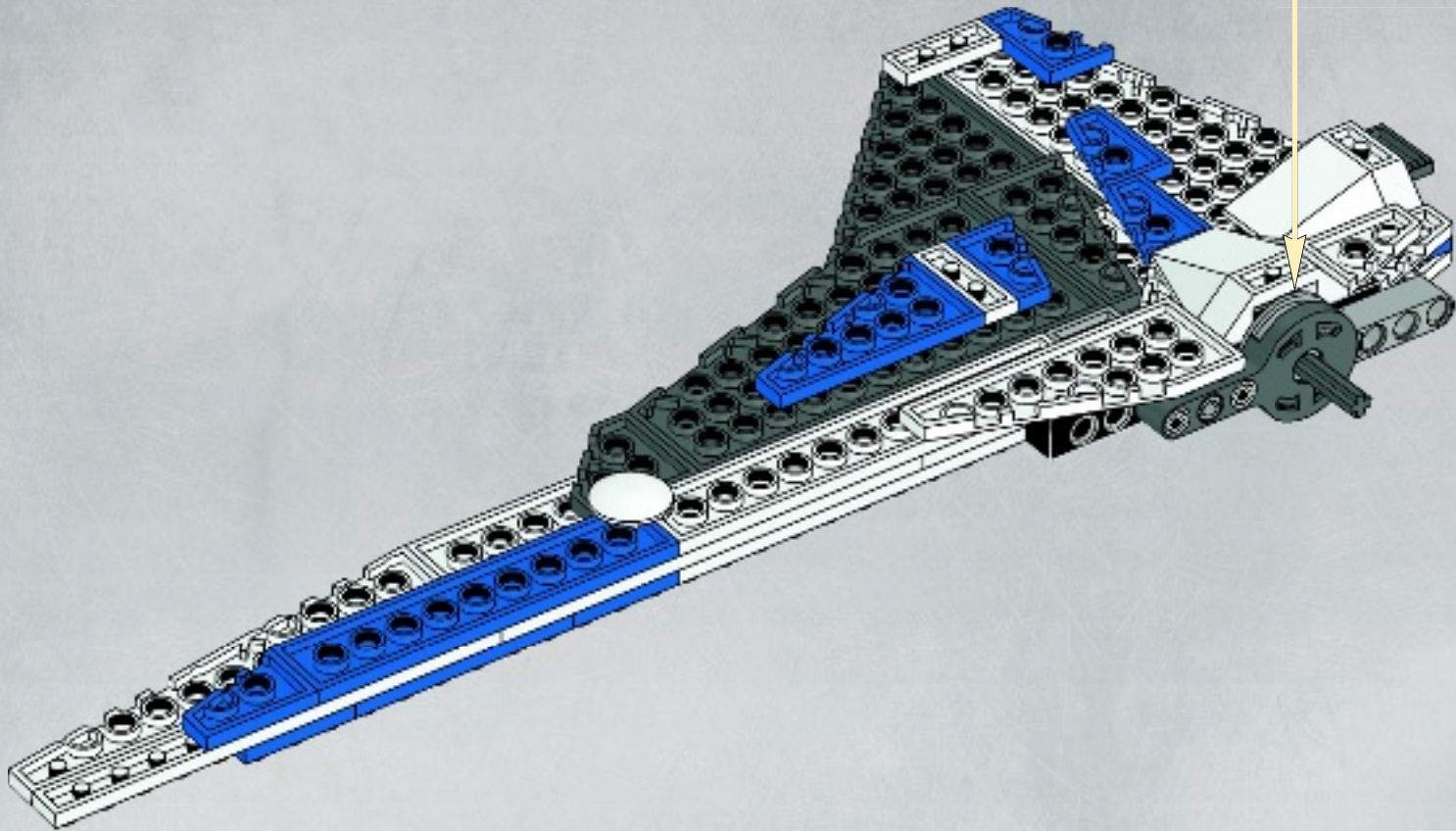
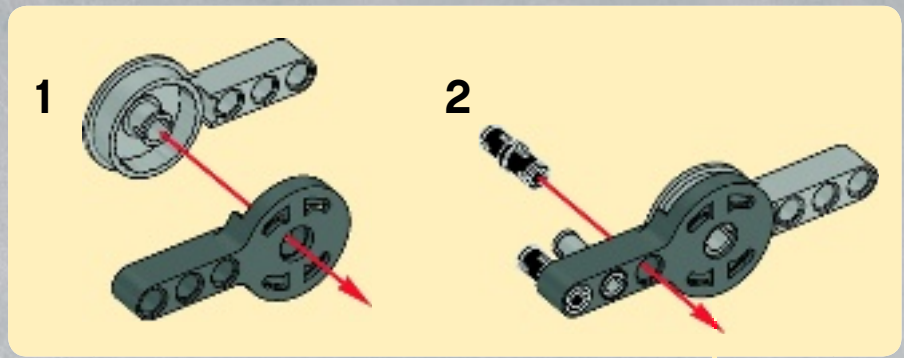



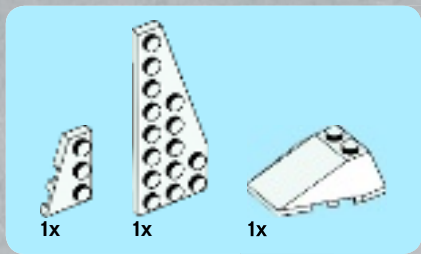

21

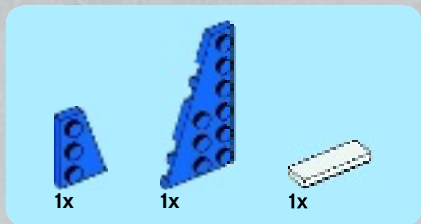
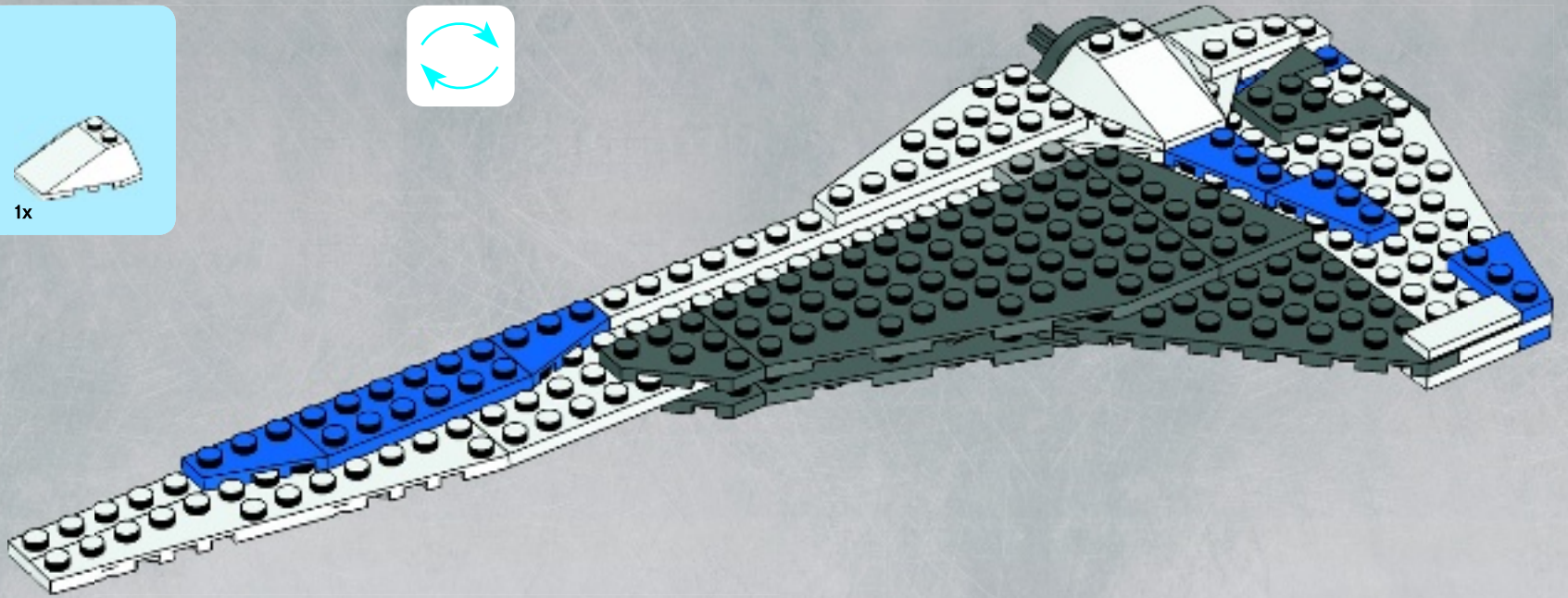

22

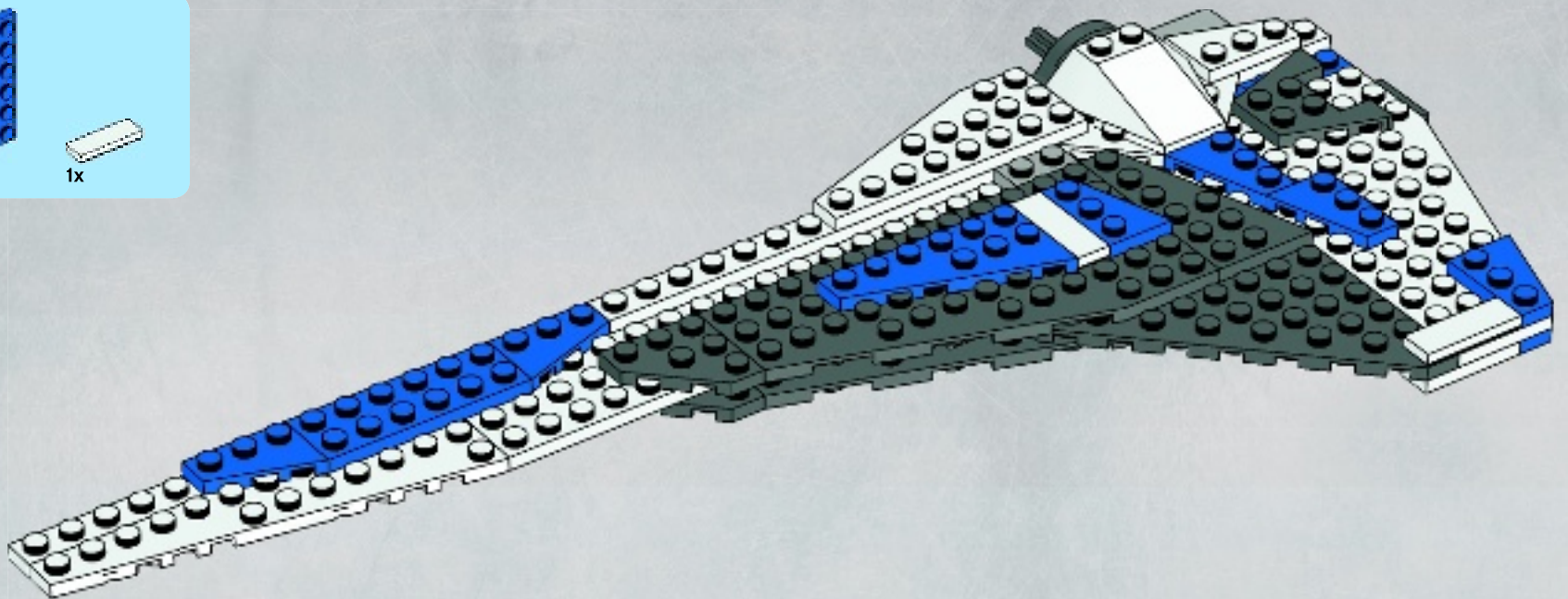



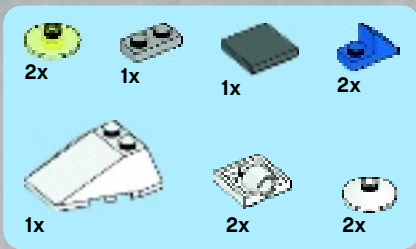

23

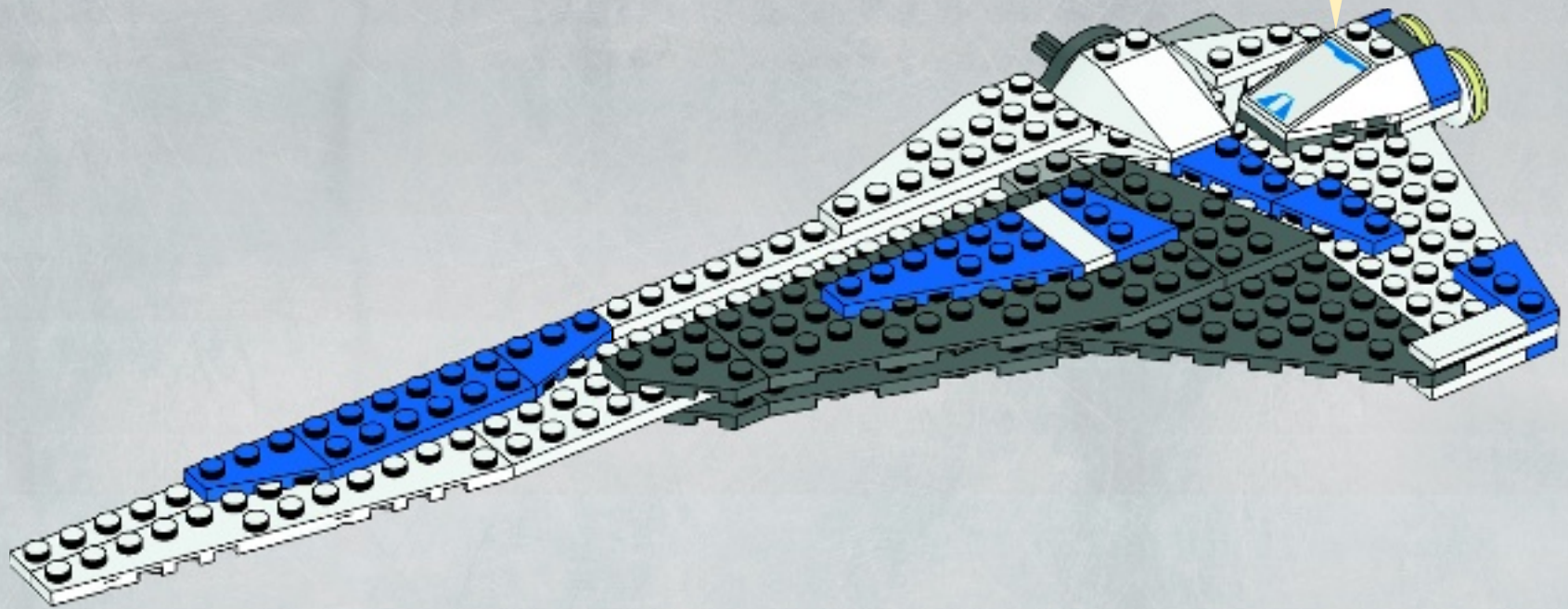
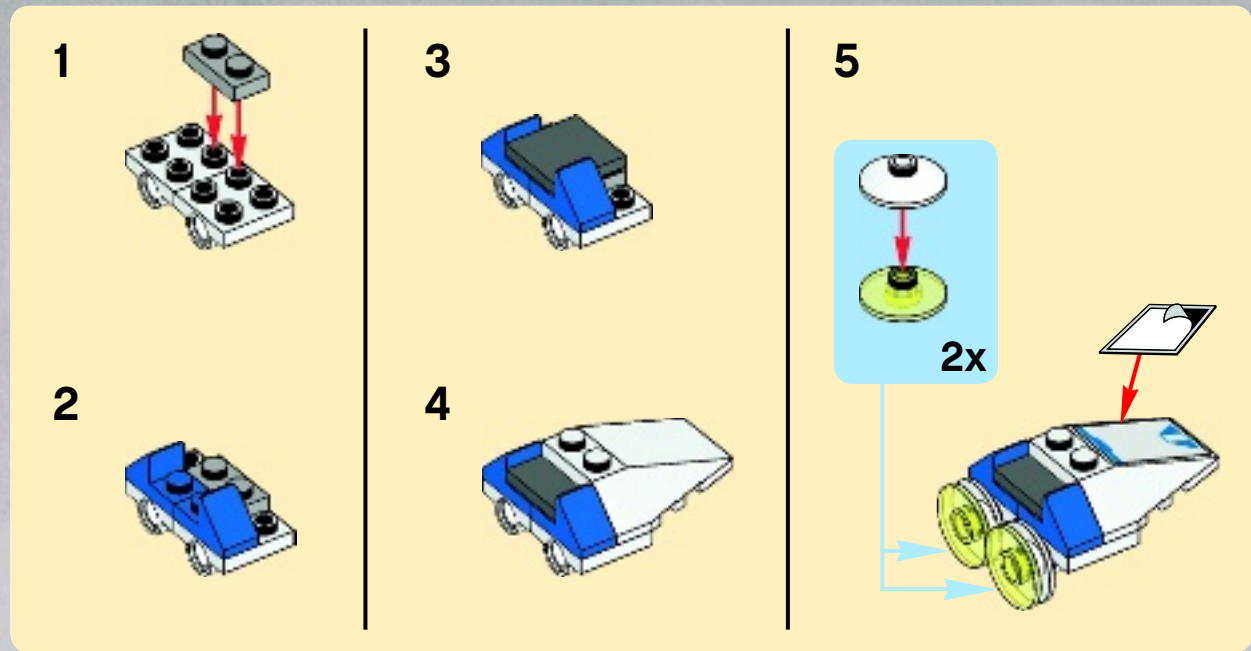



43

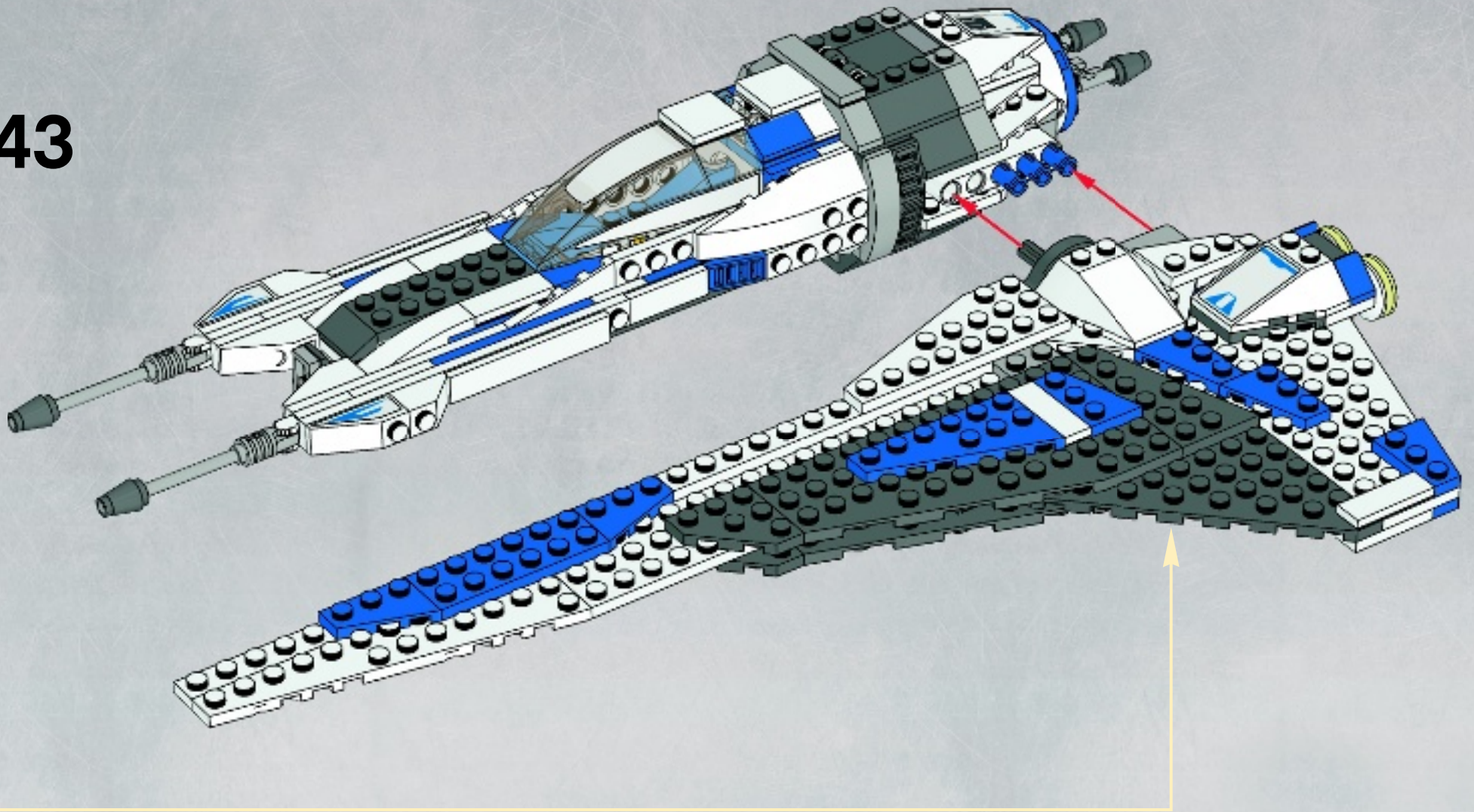





1x



1



1x



1x

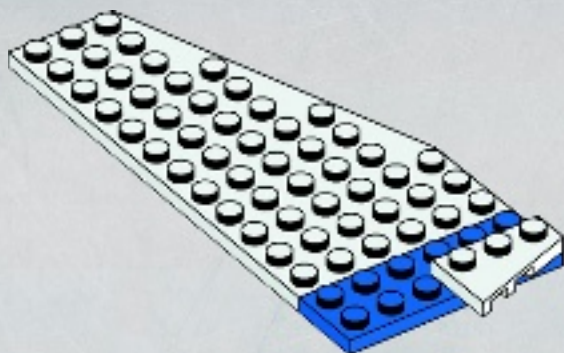

2



1x

3

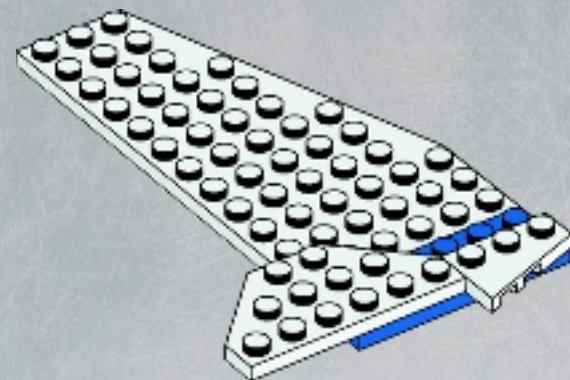

1x

4

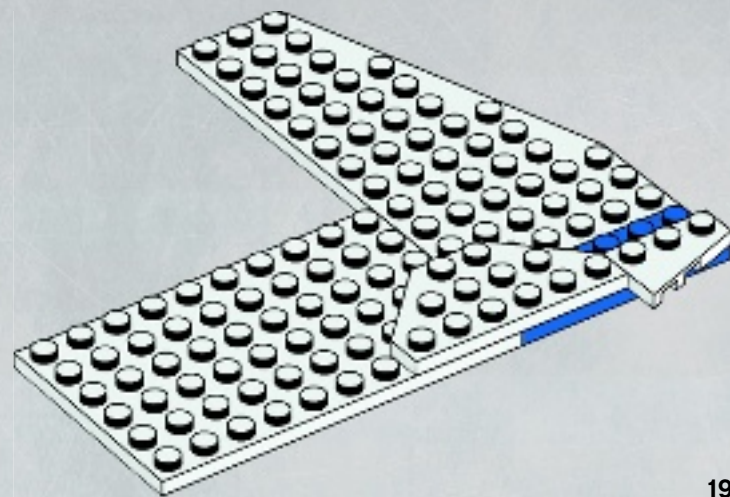



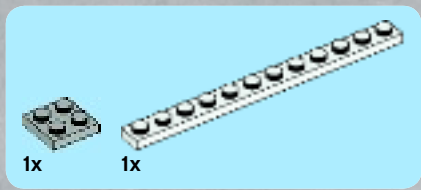

5

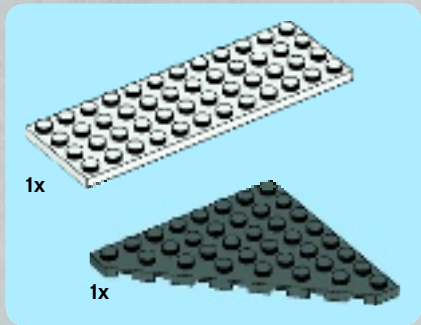
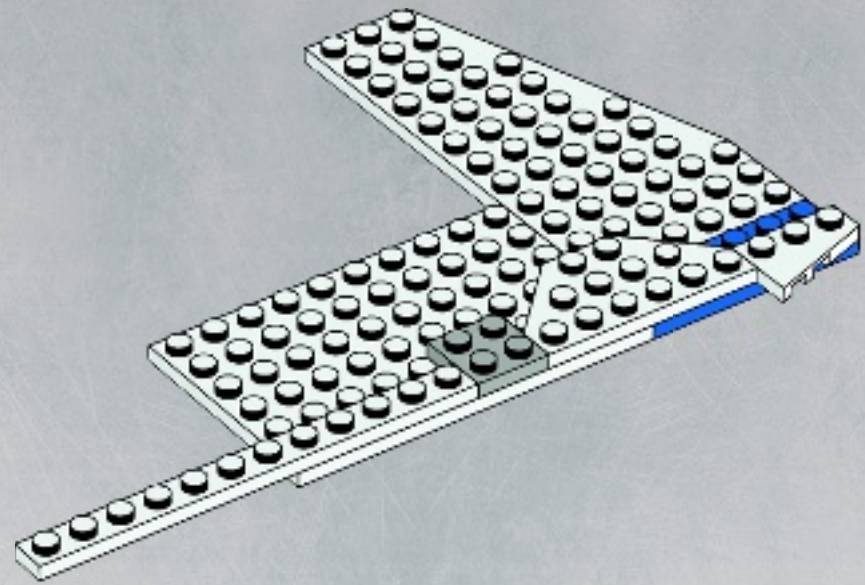

6

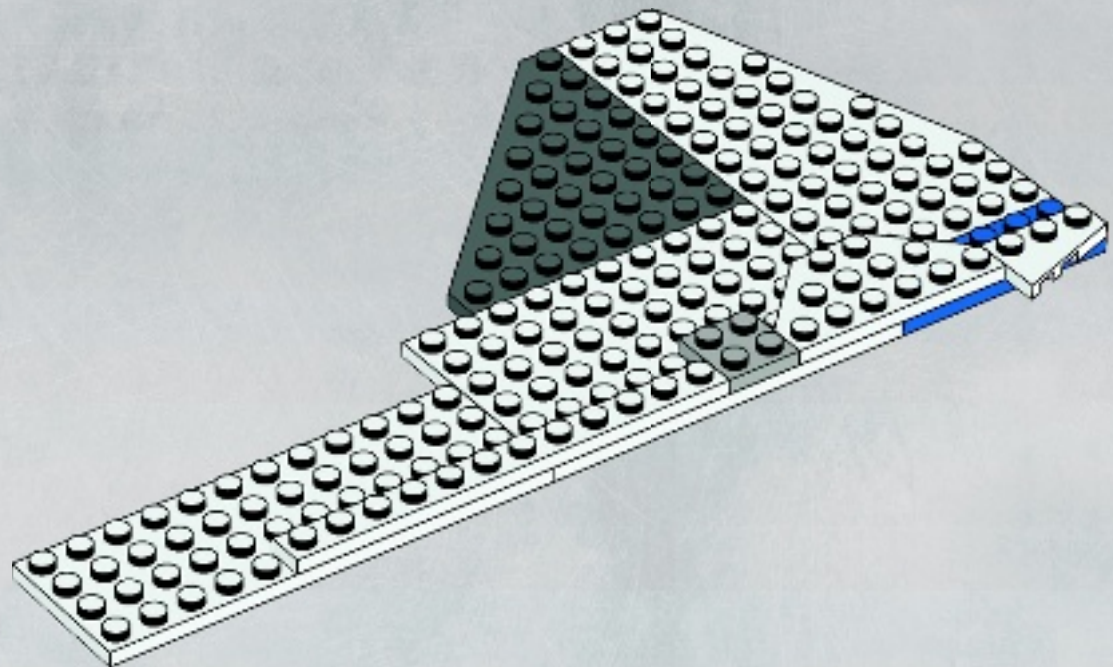



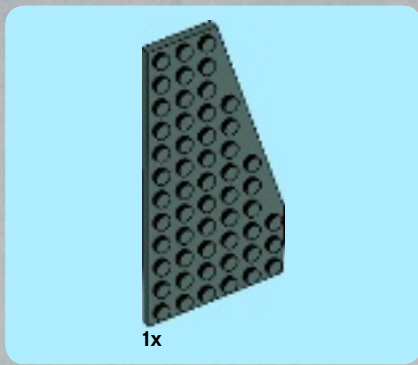

7

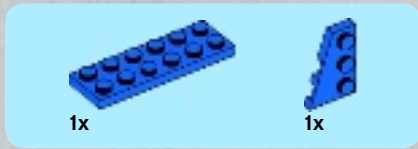
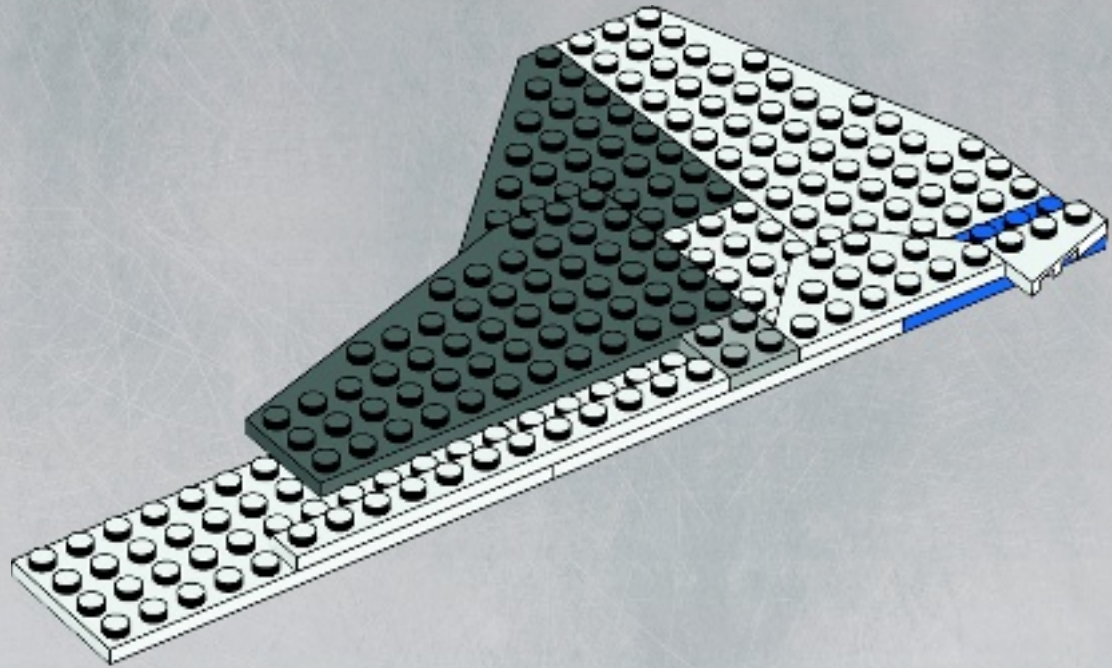

8

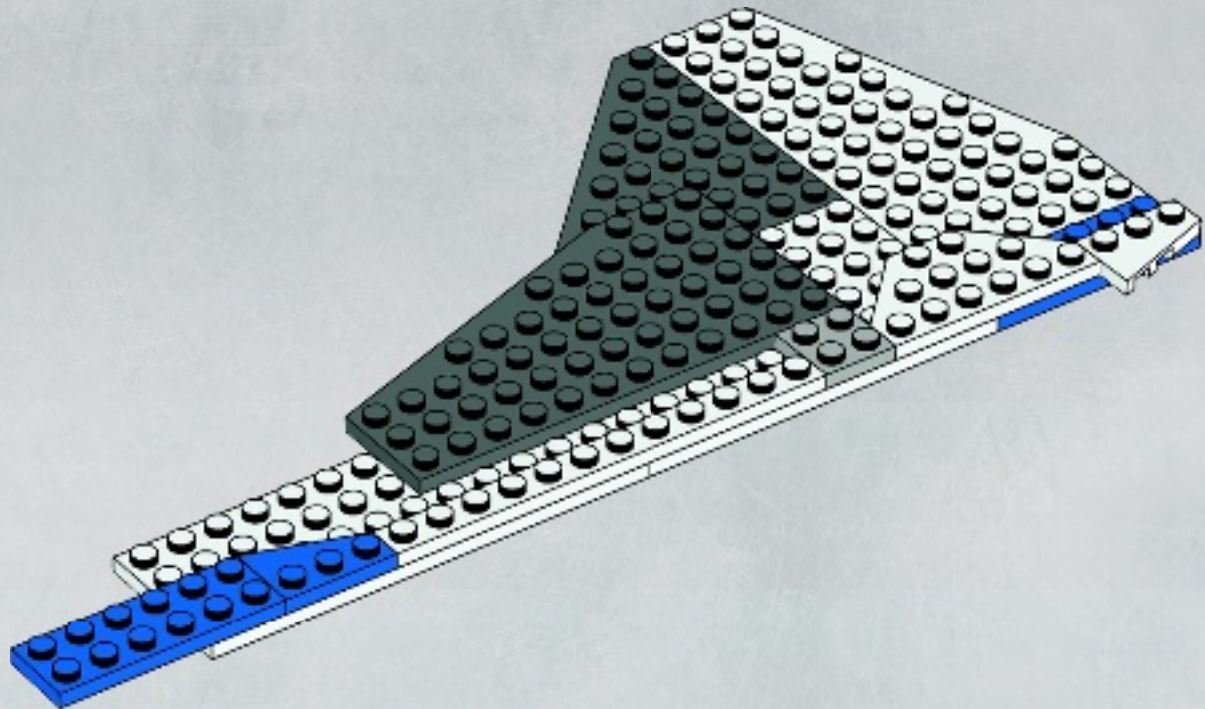



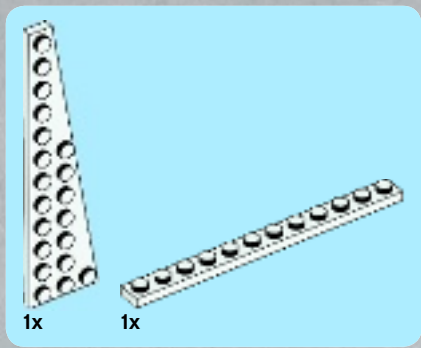

9

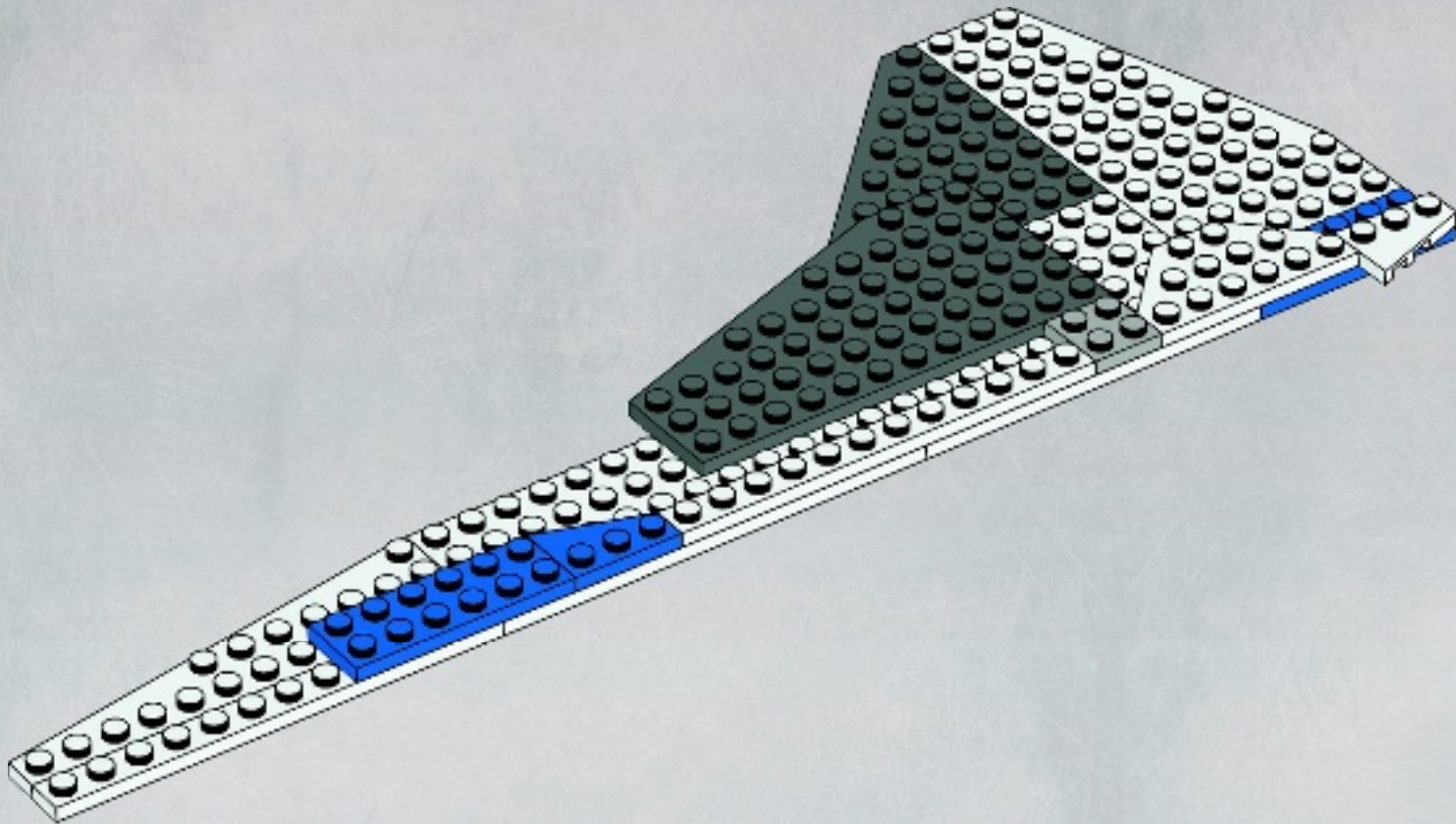



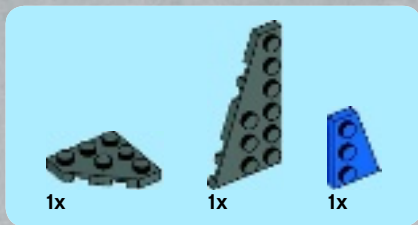

10

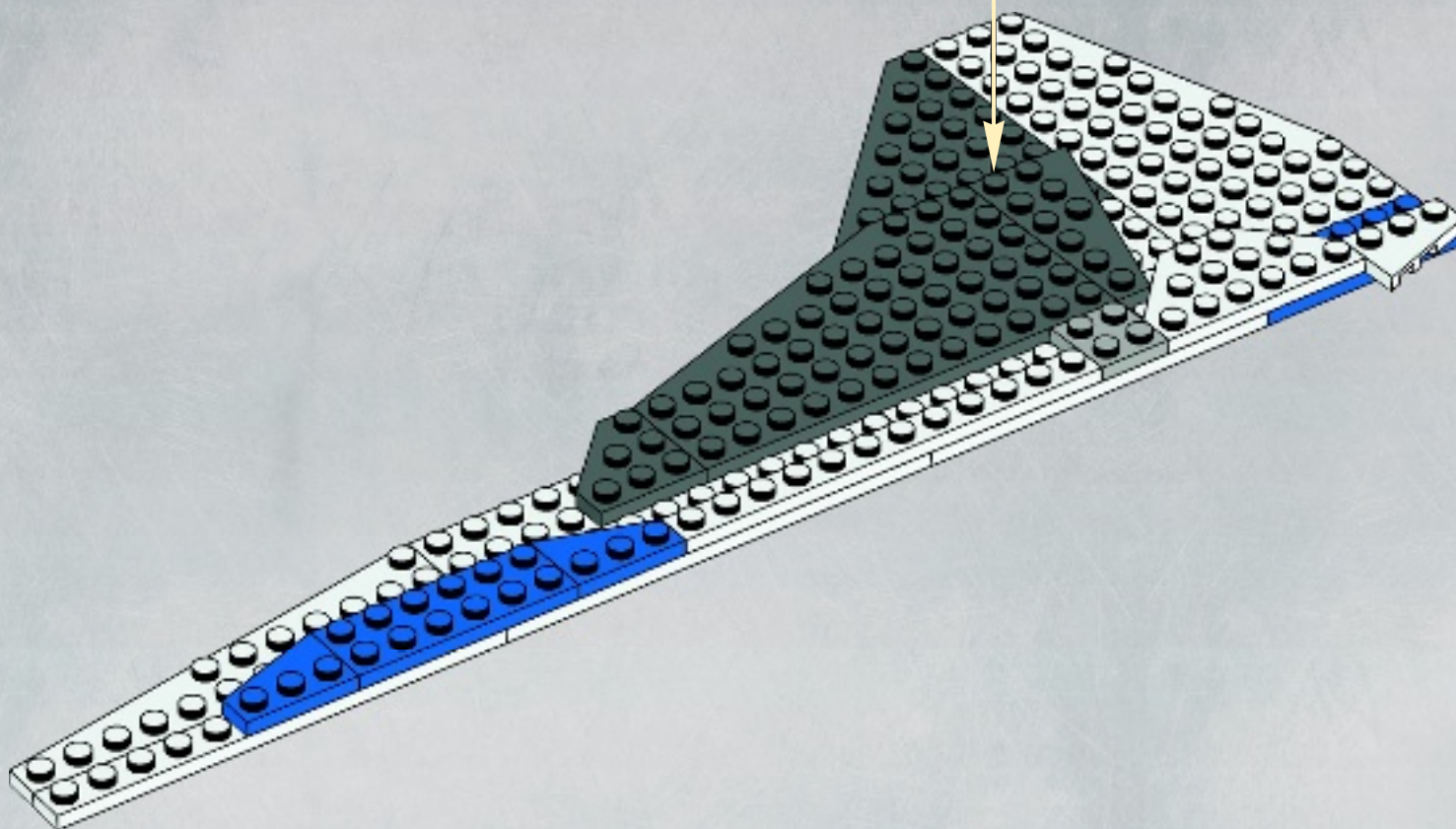
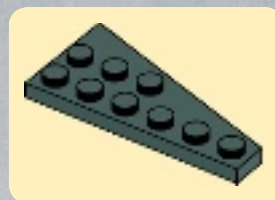



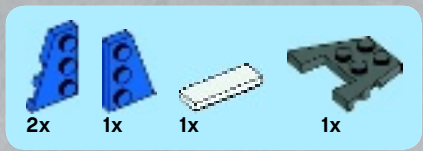

11

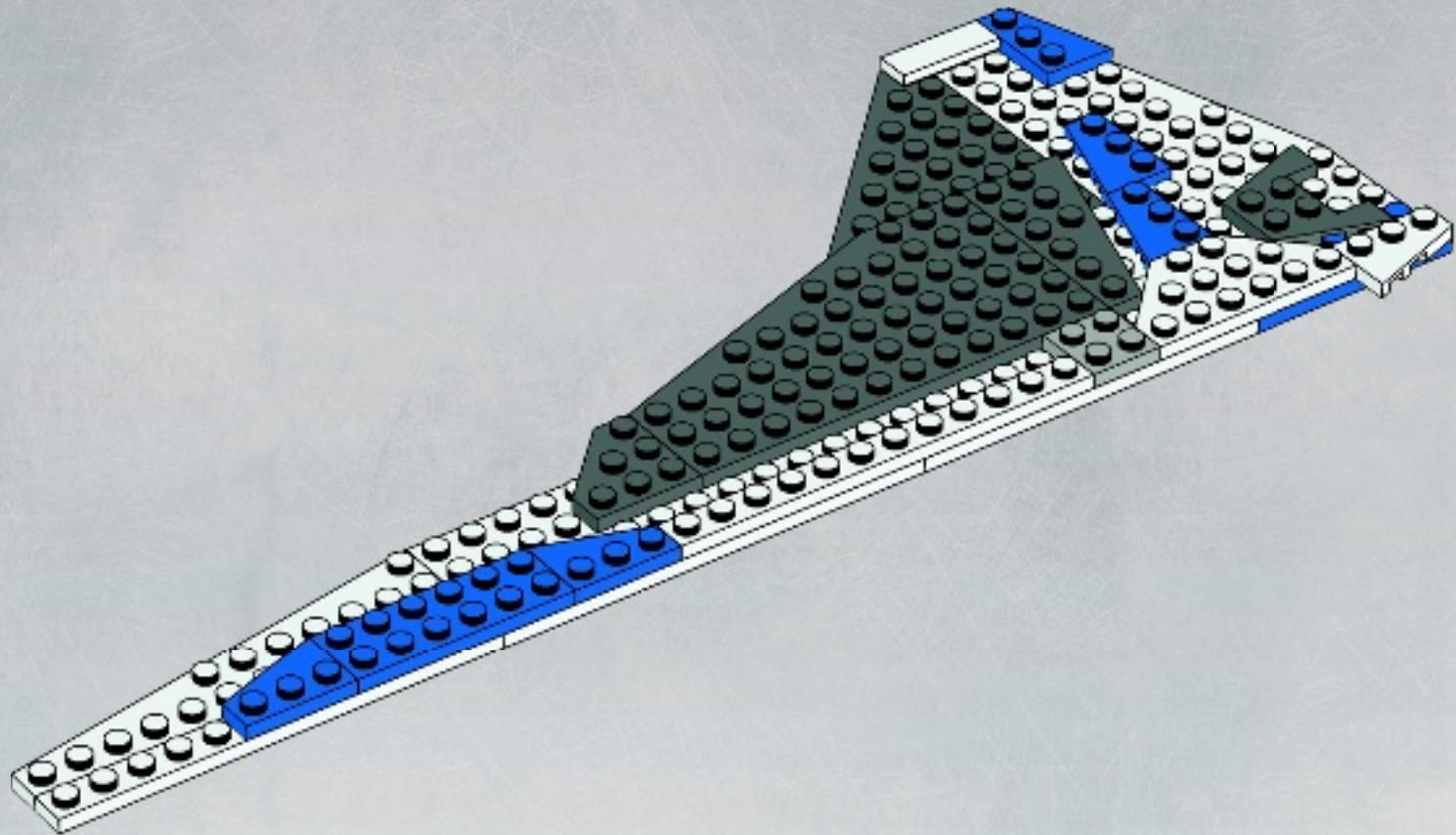



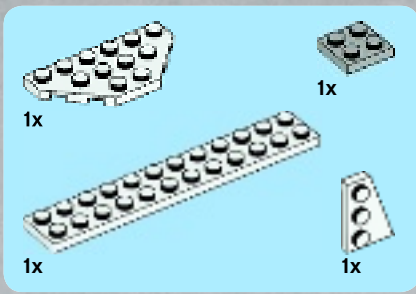

12

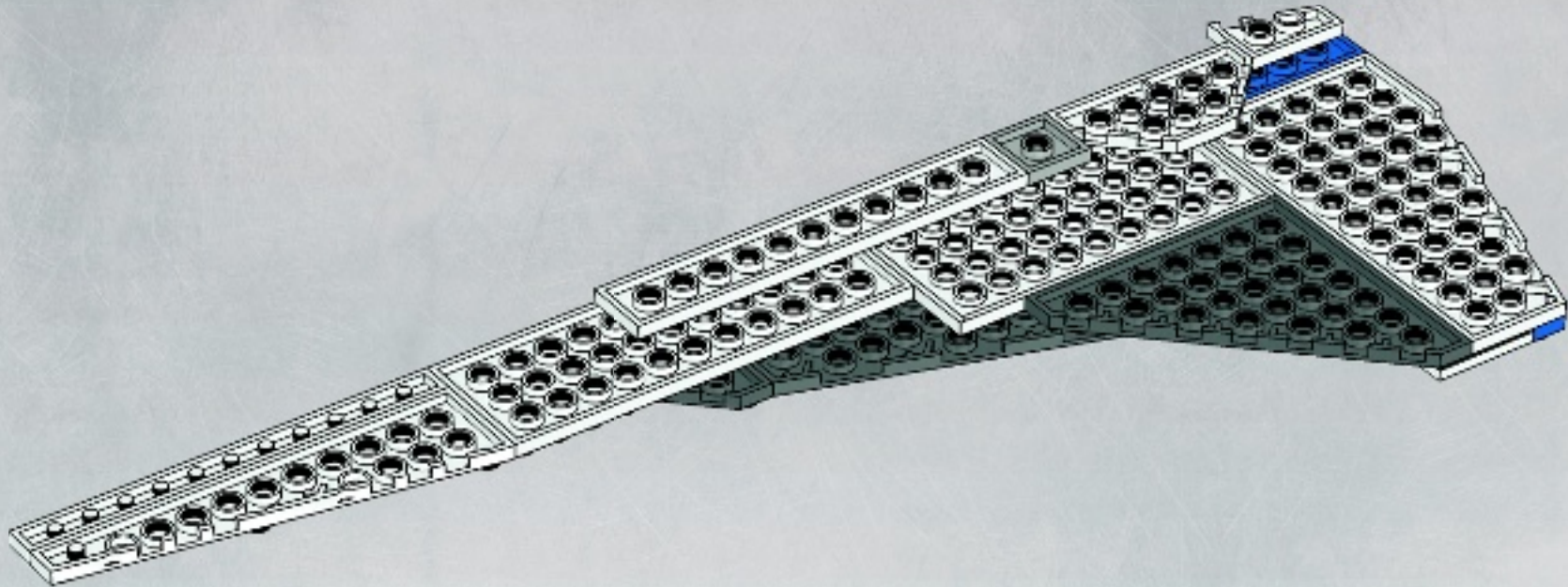

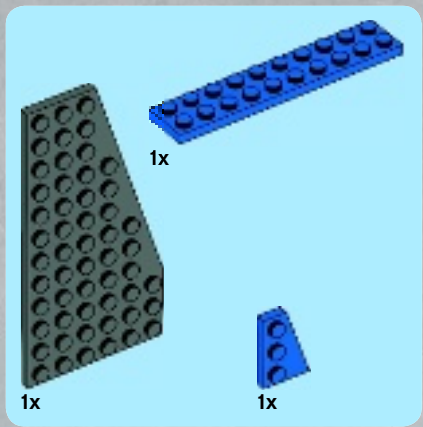

13

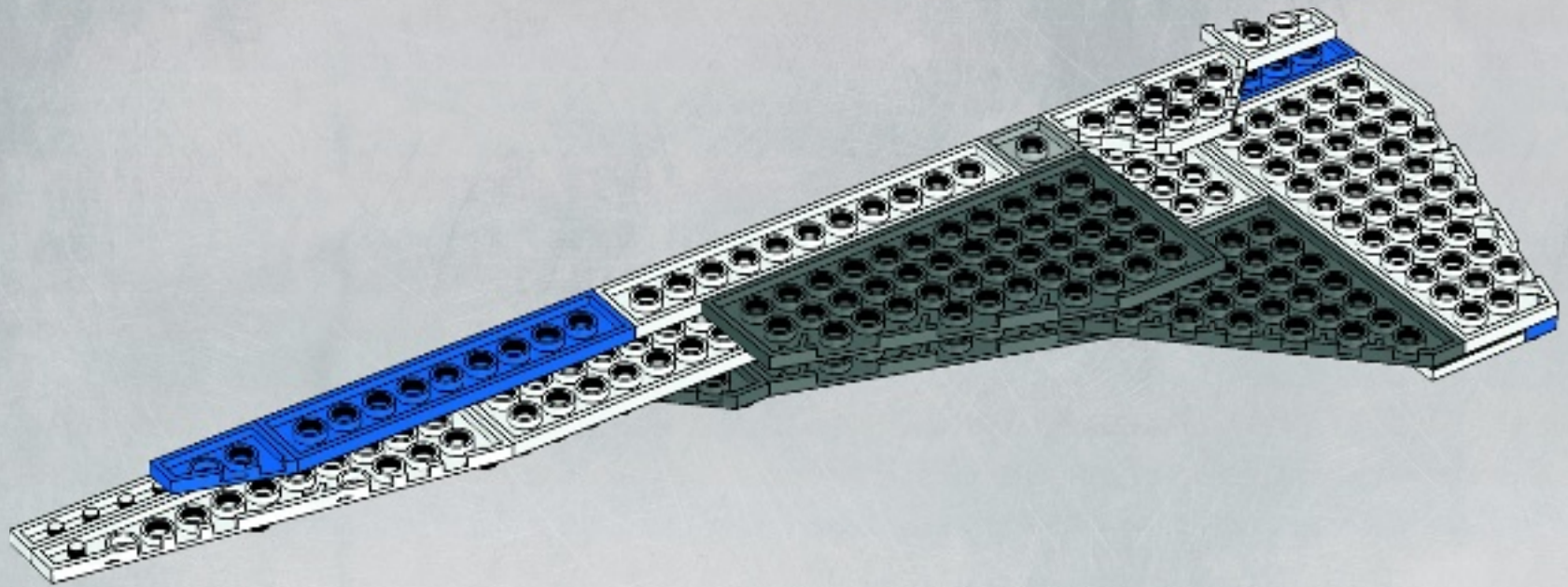



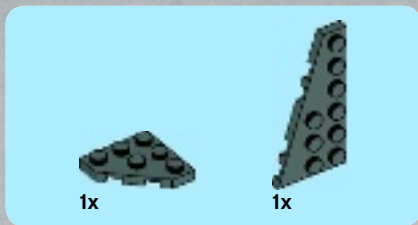

14

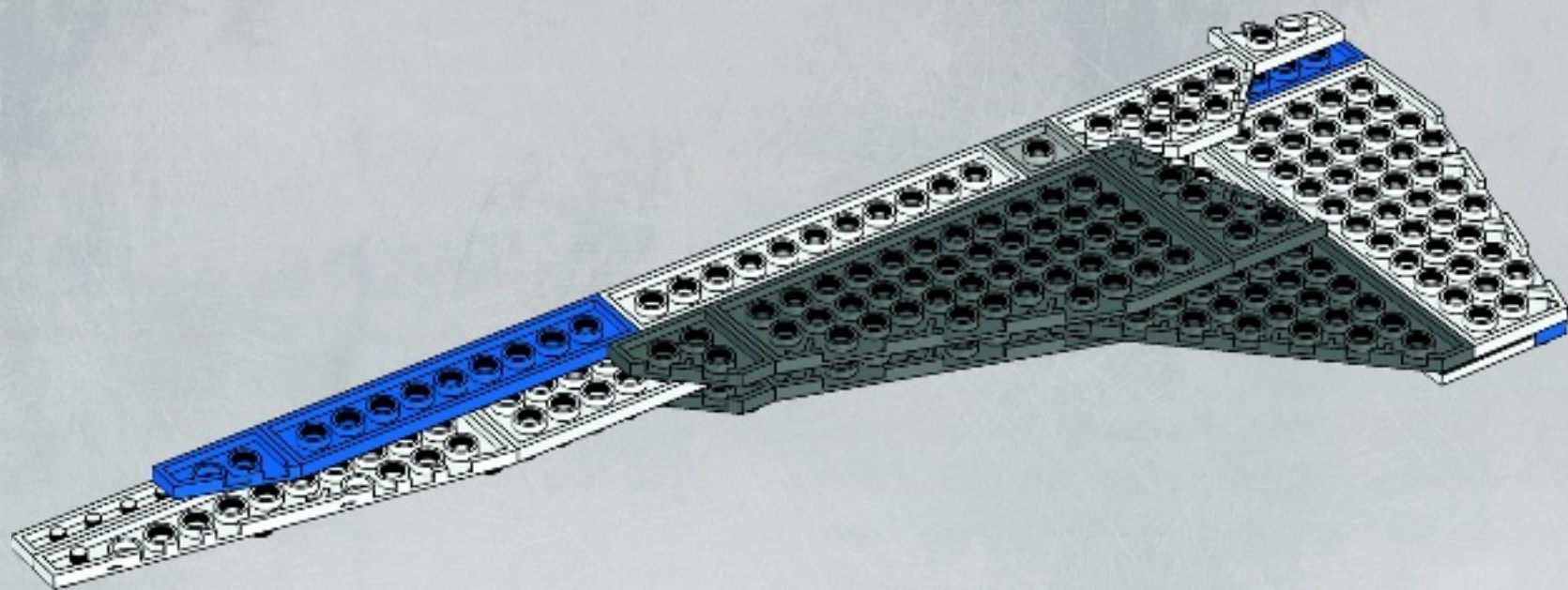



1x



2x



1x

15

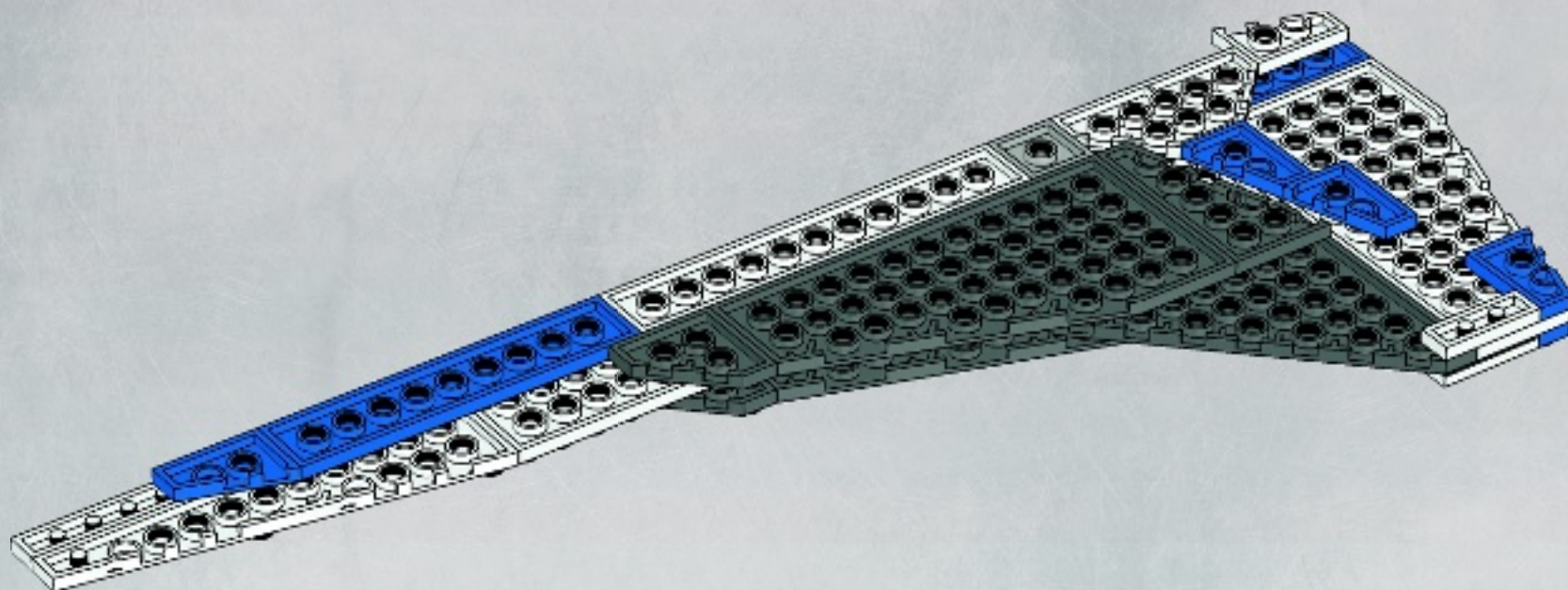





16

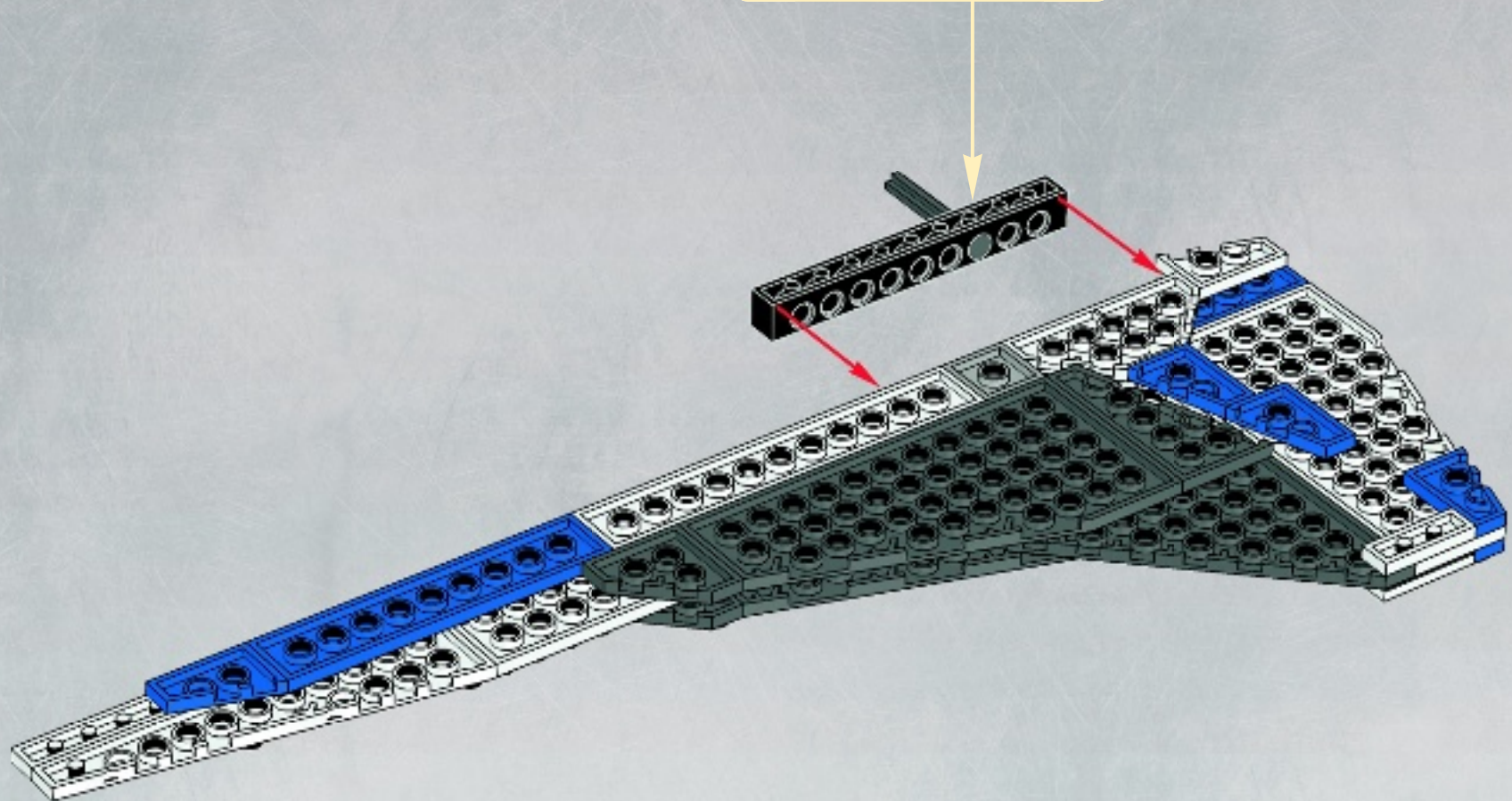
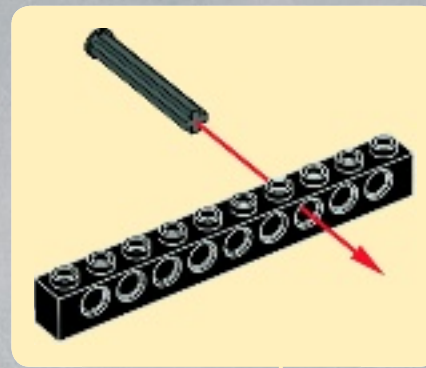



1x



1x

17

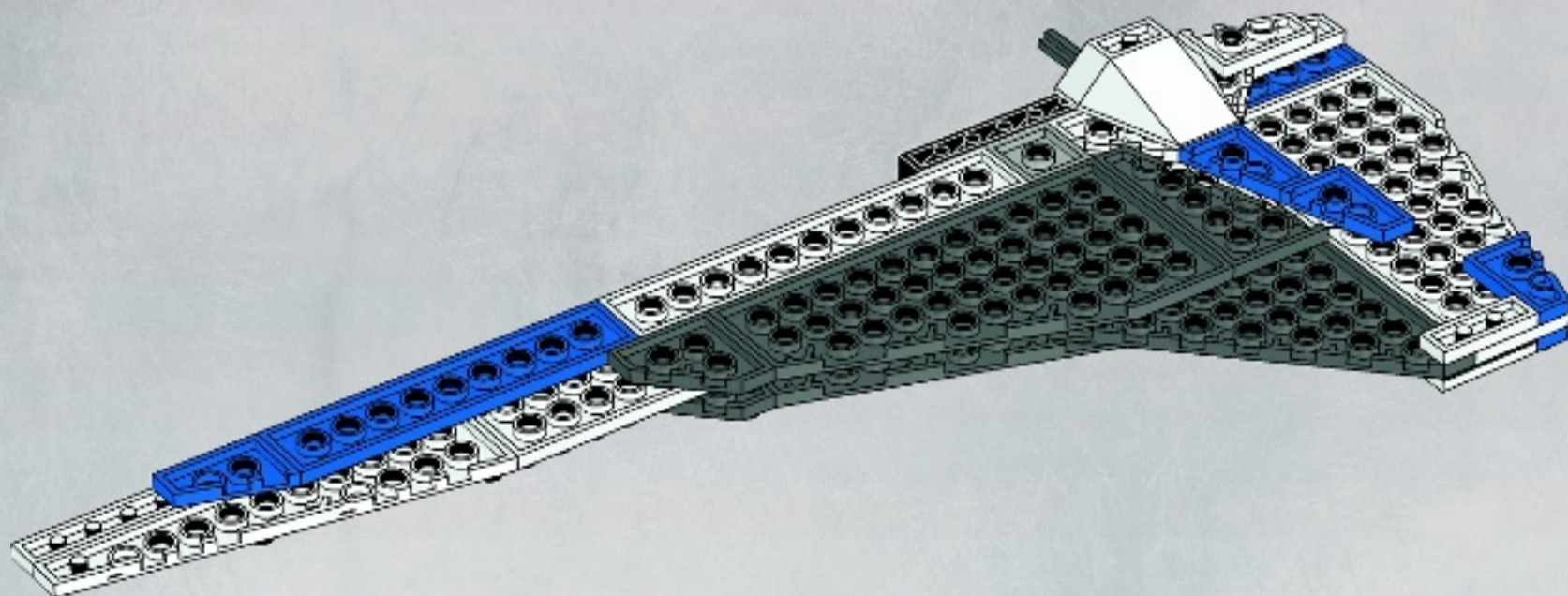



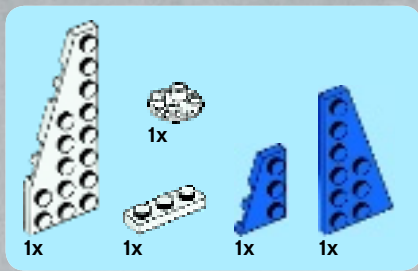

18

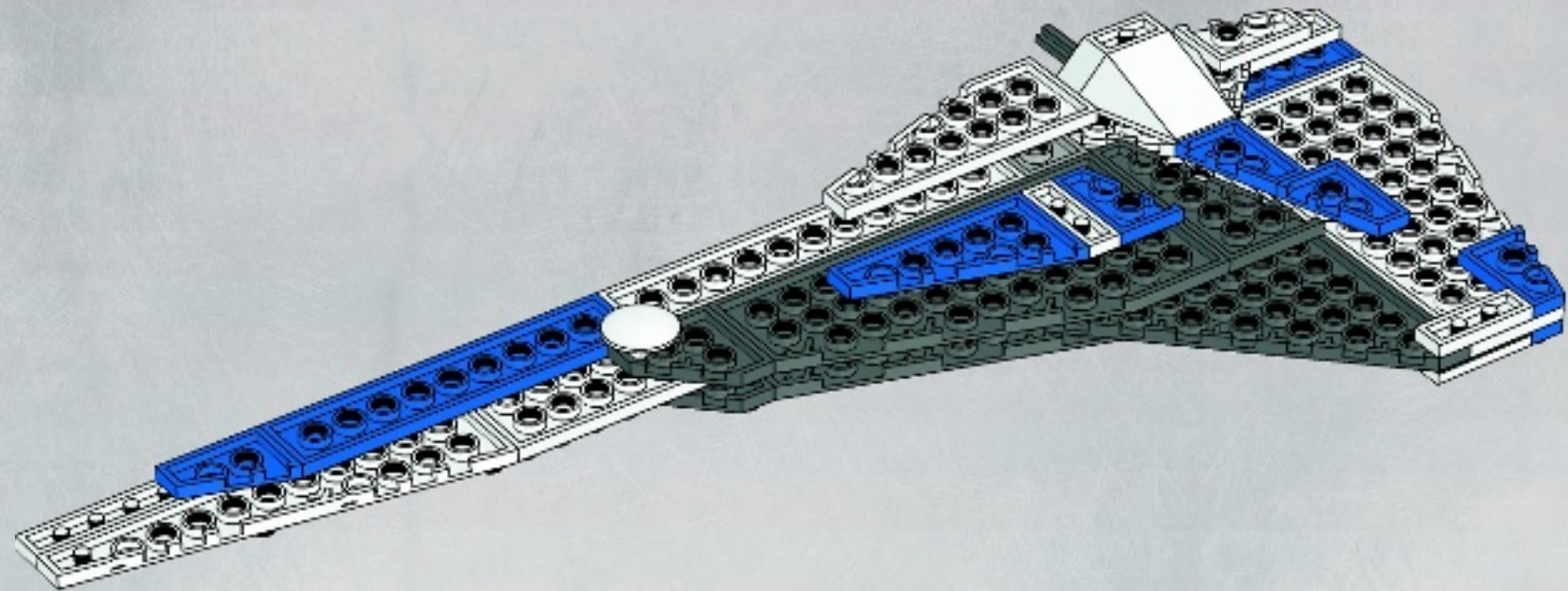



19

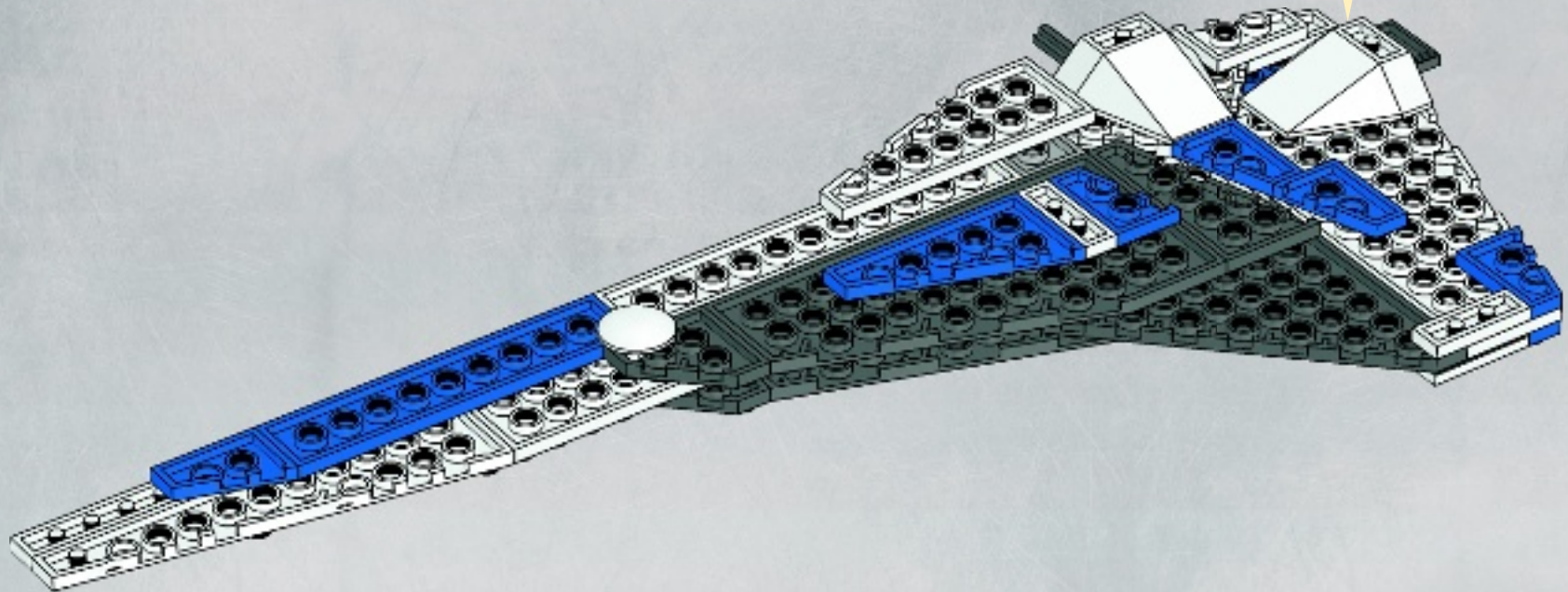
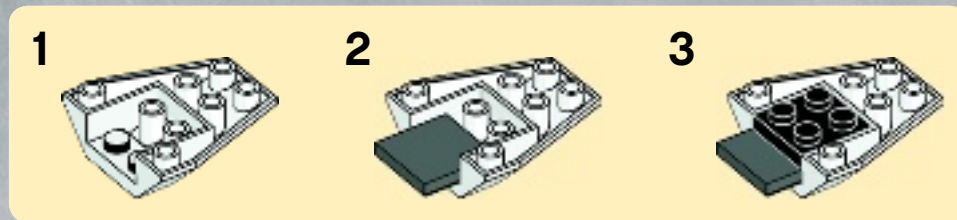



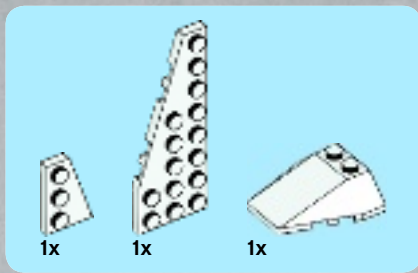

20

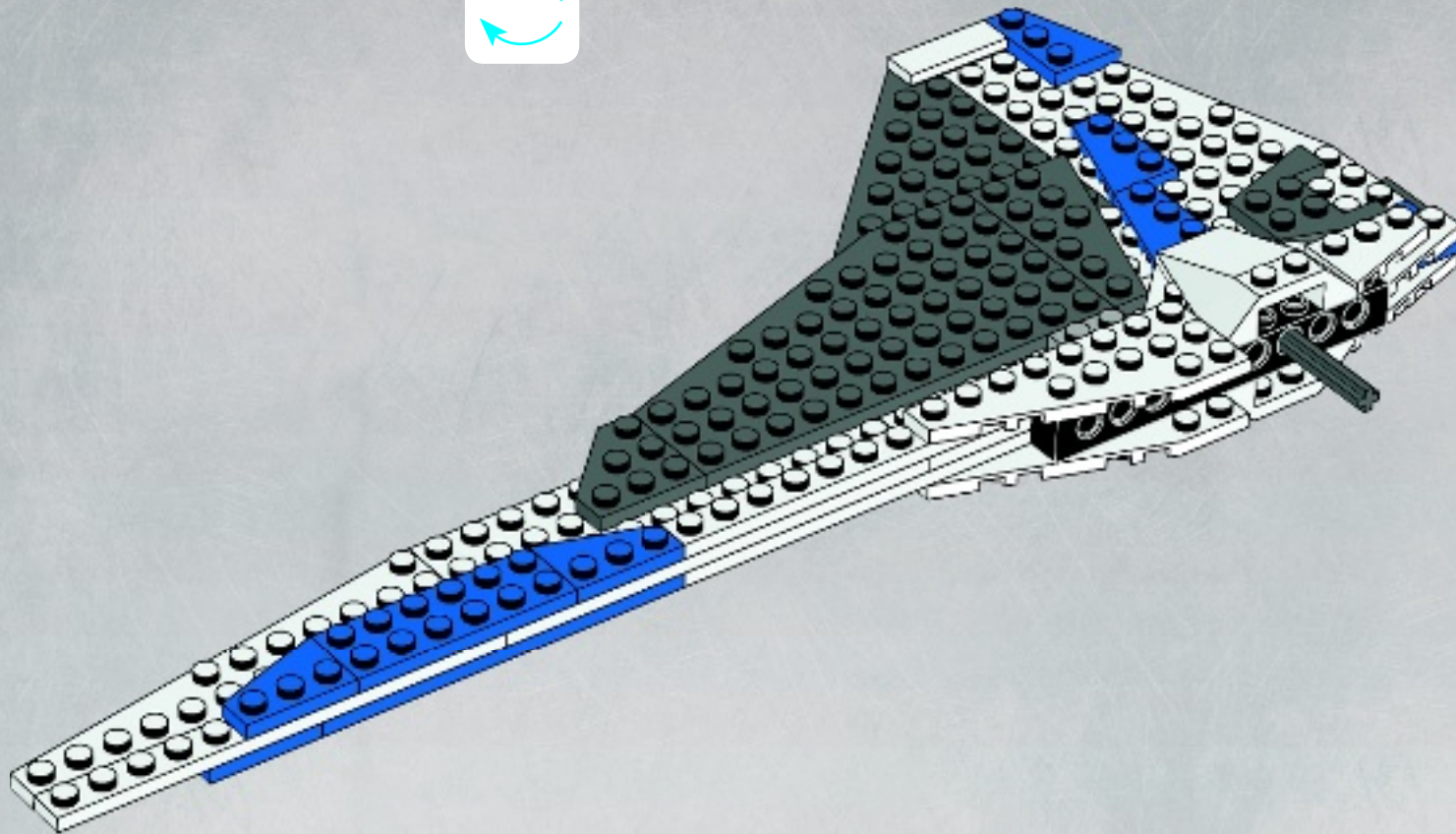

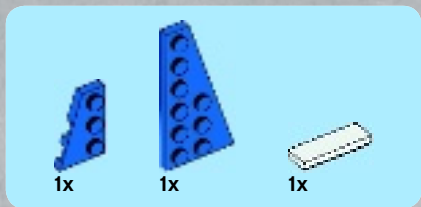

21

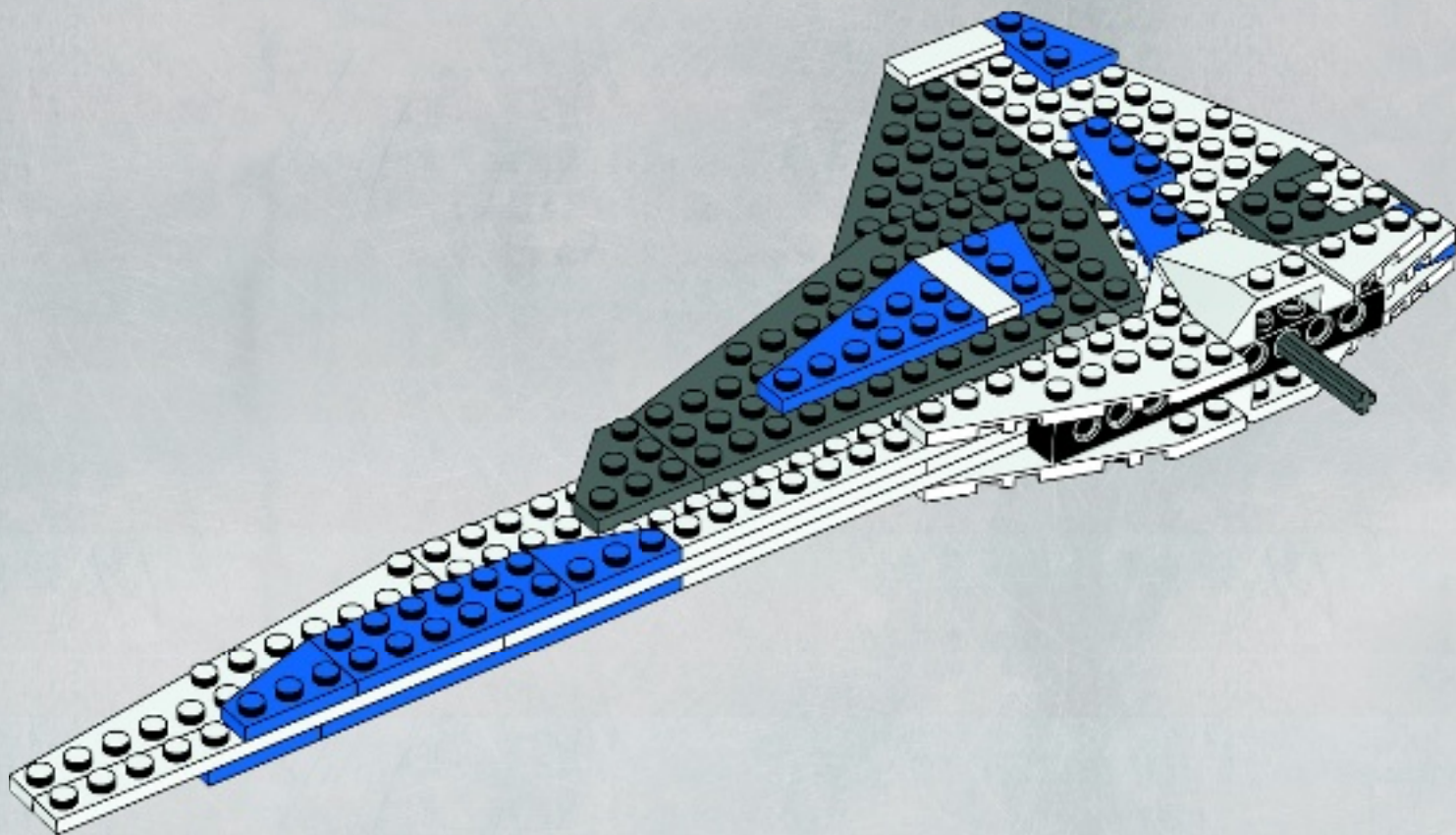



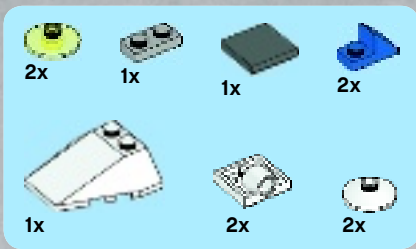

22

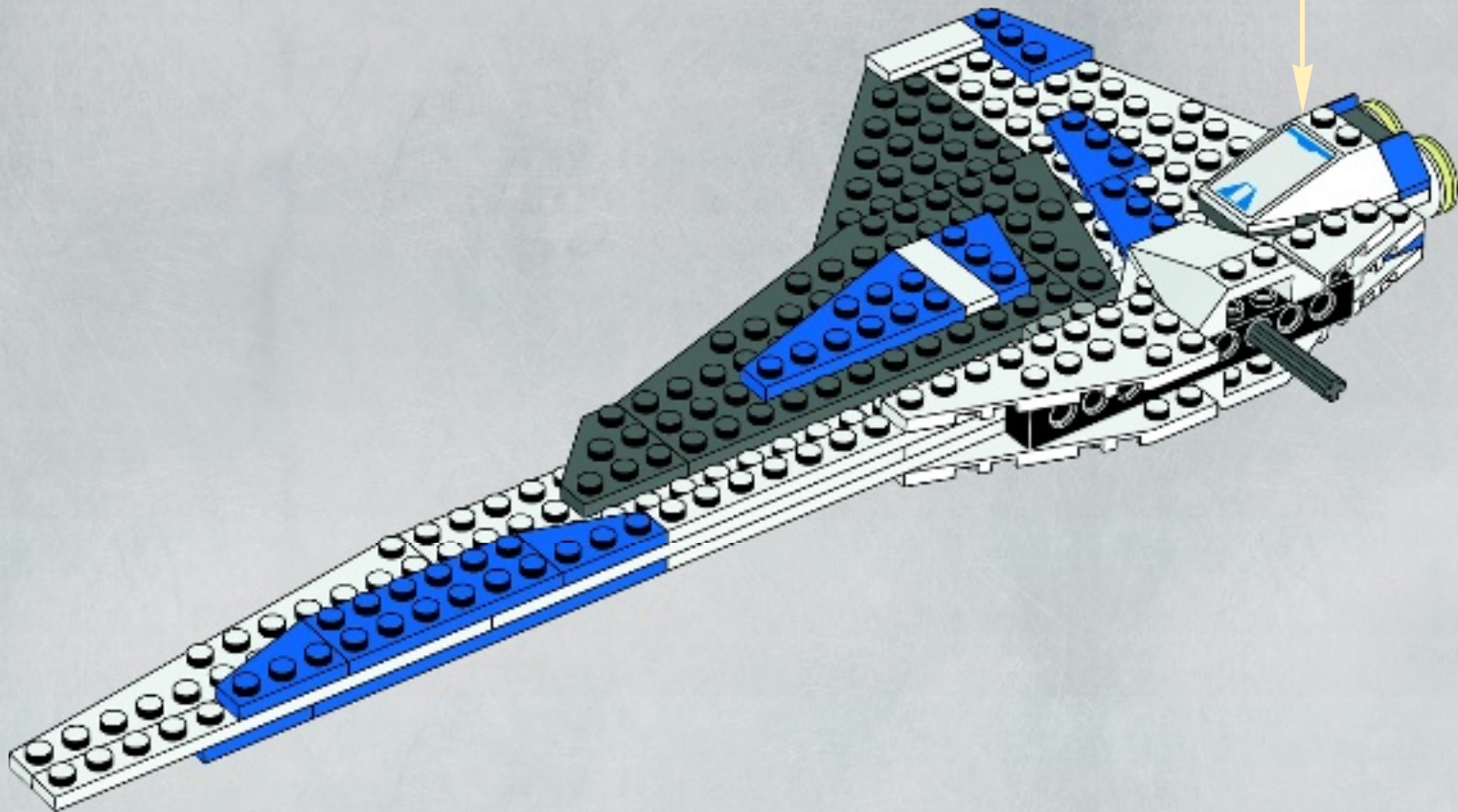
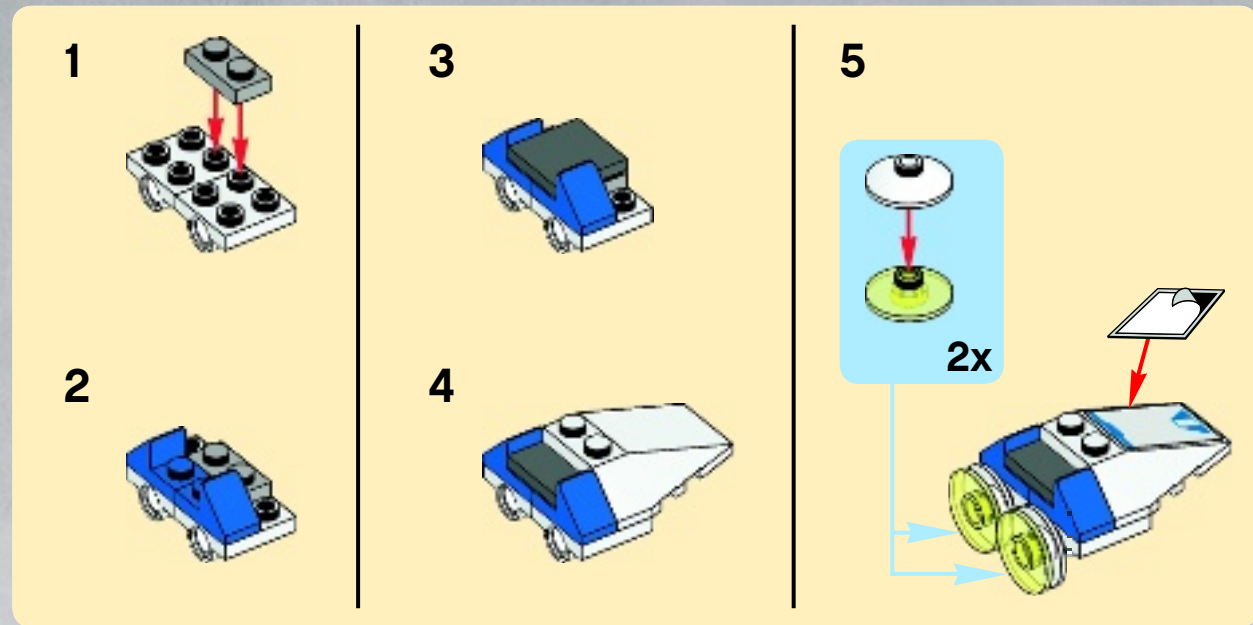

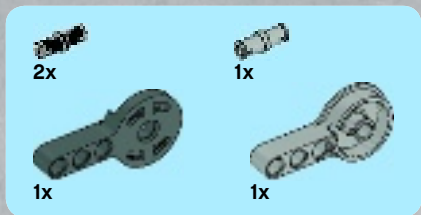

23

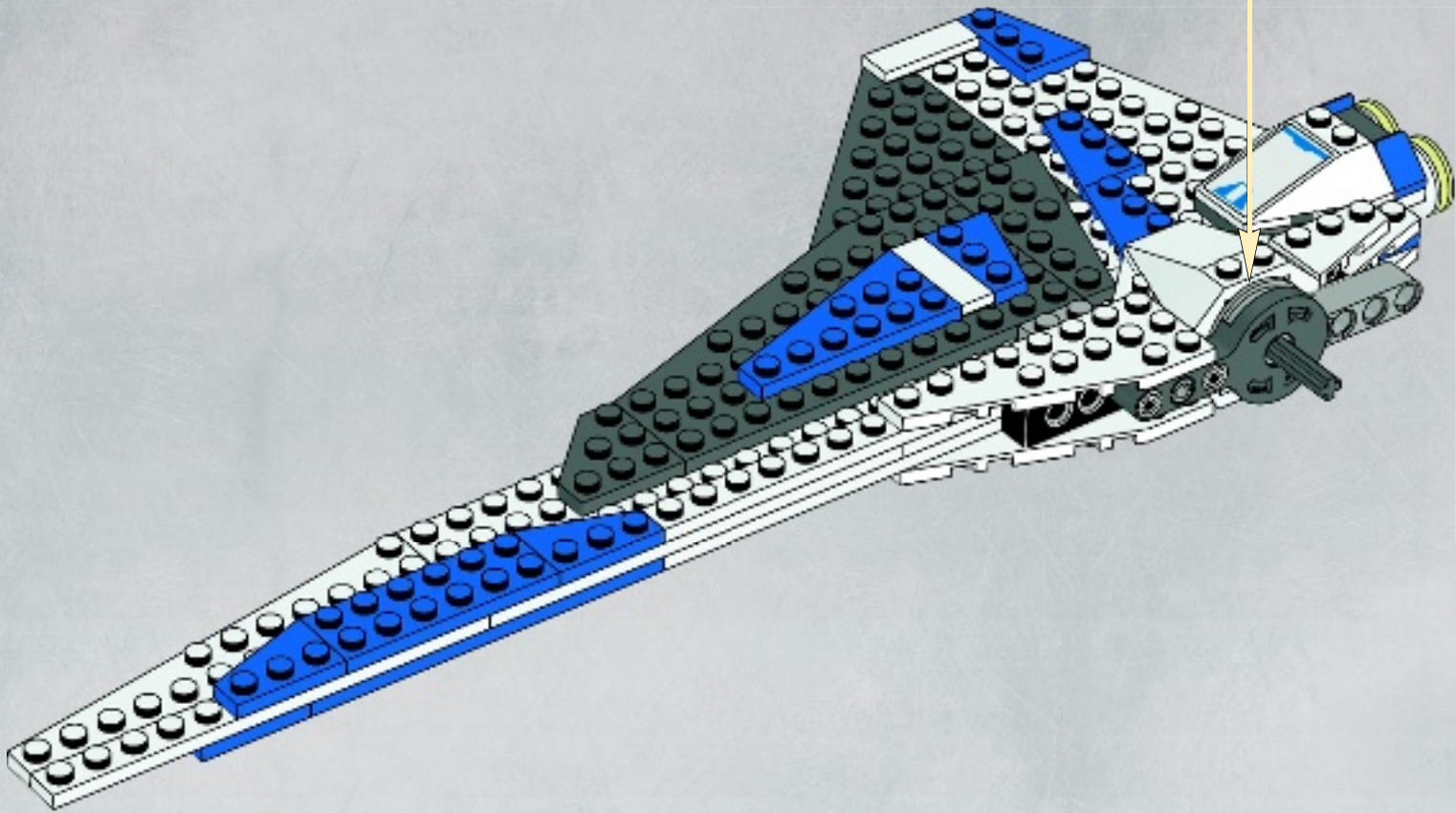
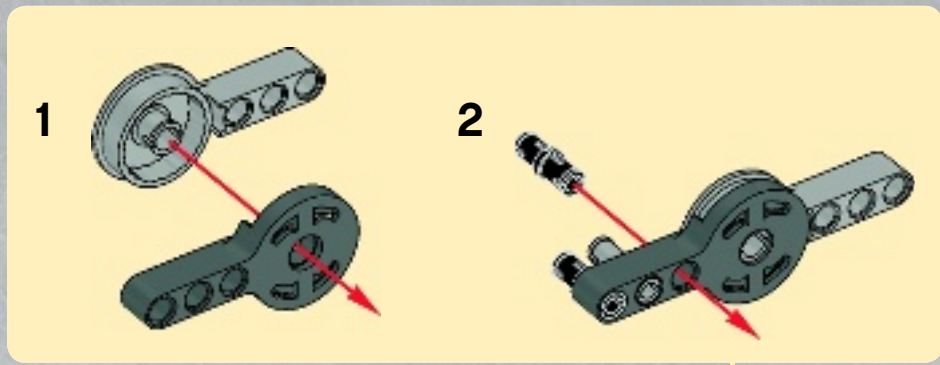



44

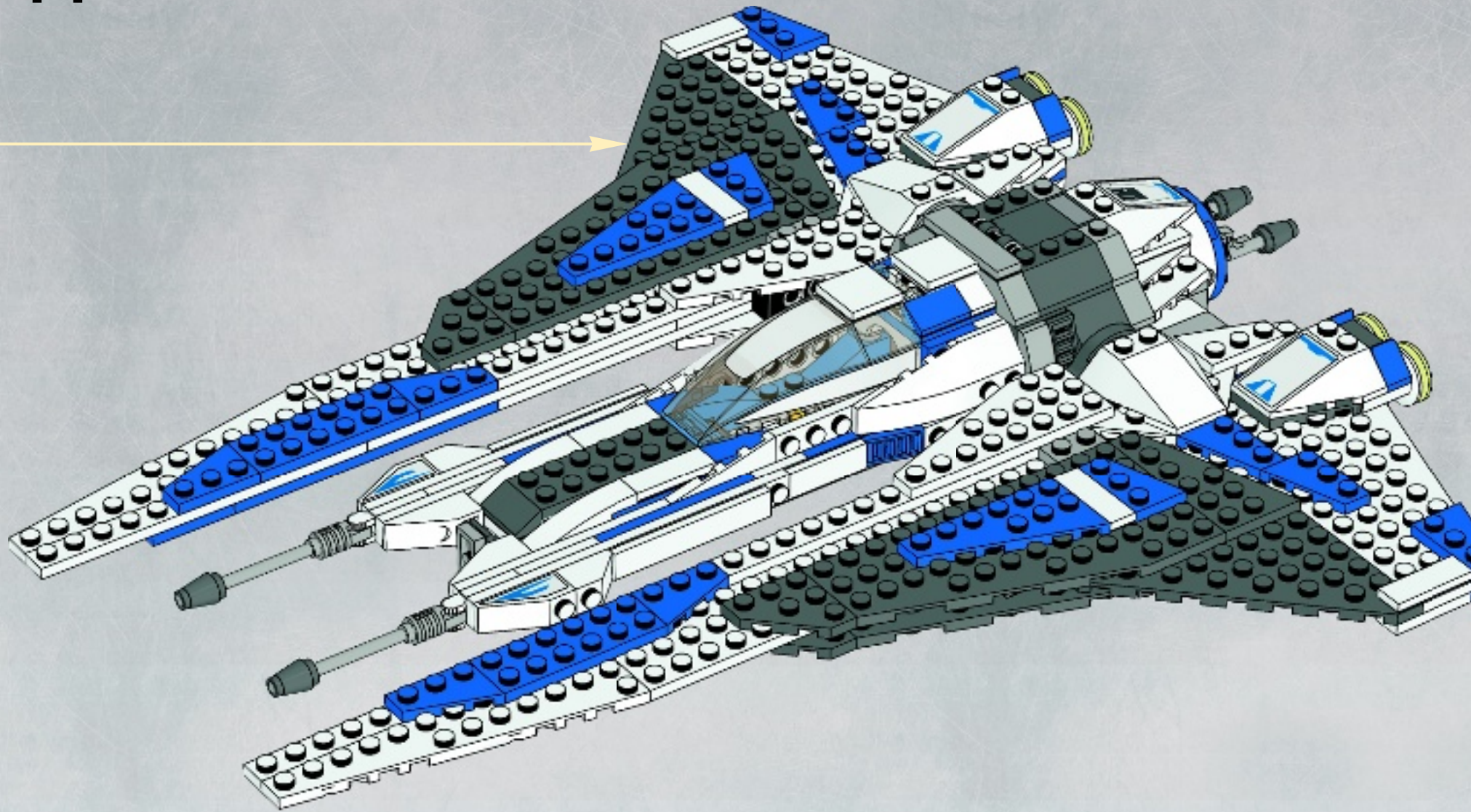







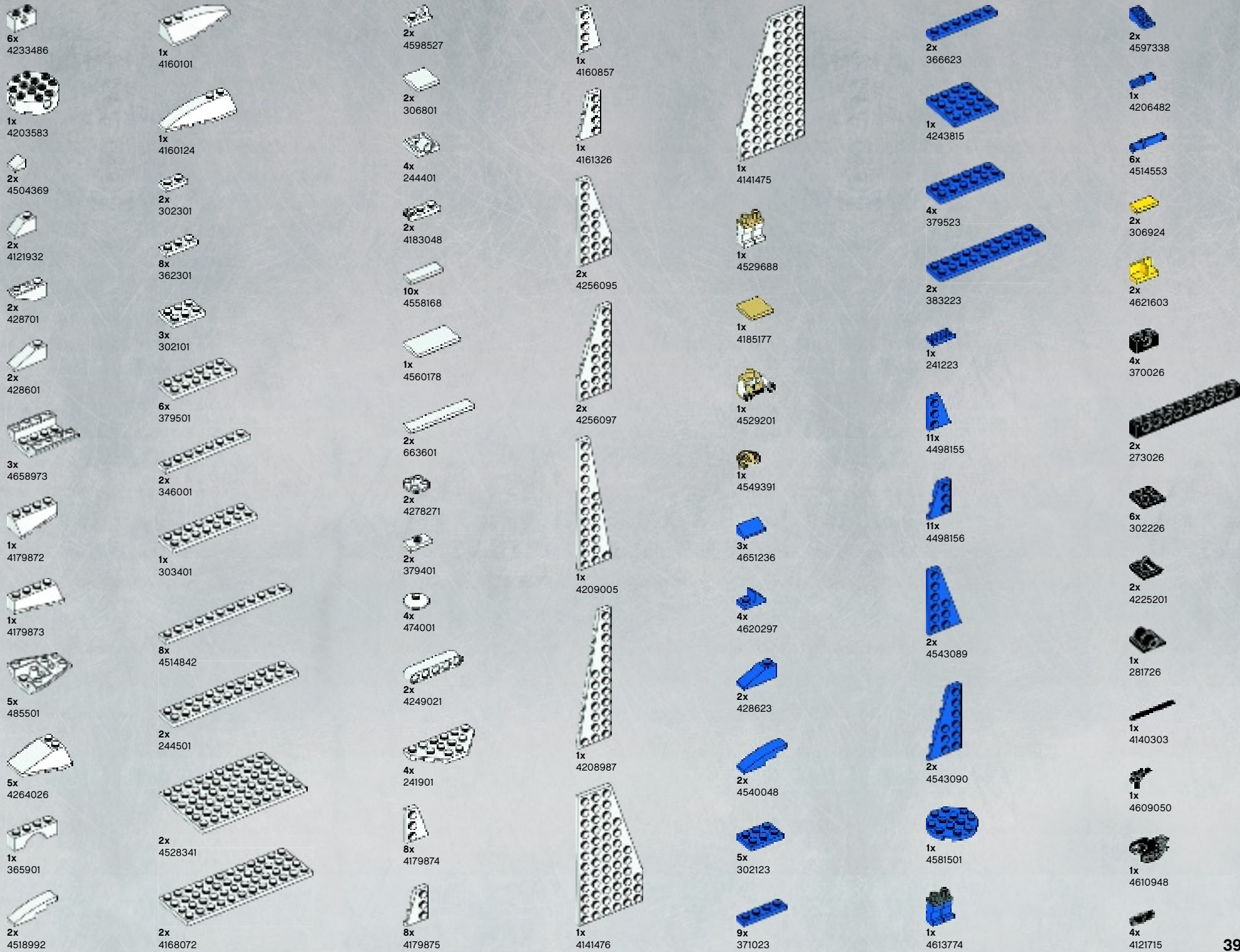



1x  
4598530



1x  
6009228



1x  
6009163



1x  
4613740



1x  
6006224



4x  
4211428



1x  
4211716



1x  
4211570



6x  
4211614



11x  
4211398



4x  
4211397



1x  
4211429



3x  
4211395



2x  
4211406



2x  
4211369



1x  
4515341



1x  
4598526



2x  
4654580



1x  
4211803



1x  
4615837



10x  
4654577



1x  
4515369



2x  
4211356



2x  
4622803



8x  
4211525



2x  
4538098



2x  
4514195



2x  
4211679



2x  
4211800



2x  
4211807



2x  
4211815



1x  
4609091



1x  
4598788



4x  
4540386



4x  
4558955



1x  
4210636



1x  
4497253



1x  
4504378



3x  
4567887



2x  
4210862



2x  
4211054



2x  
4218188



1x  
4211106



4x  
4529240



7x  
4211094



2x  
4211133



2x  
4277928



4x  
4211055



1x  
4211053



2x  
4227517



2x  
4596895



2x  
4290150



2x  
4290149



2x  
4290149



2x  
4271543



2x  
4271542



2x  
4271542



2x  
4271542



2x  
4271542



1x  
4211002



1x  
4211002



1x  
4211067



3x  
4294180



3x  
4294180



2x  
4547222



1x  
4520307



4x  
4210897



2x  
4182751



2x  
4560177



1x  
4527159



1x  
4124073



4x  
3006349



1x  
300121



1x  
4529177



1x  
6009155



1x  
4613716



2x  
4548731



1x  
6009135



1x  
6009242



**Customer Service**  
**Kundenservice**  
**Service Consommateurs**  
**Servicio Al Consumidor**  
[www.lego.com/service](http://www.lego.com/service) or dial  
  
**00800 5346 5555 :**   
**1-800-422-5346 :** 









9677



9678



9679



9469



9497



9498



9499



9500



9515



9516





9496



9496



9496



9496



9497



9497



9497



9498



9498



9498



9499



9499



9499



9499



9500



9500



9500



9515



9515



9515



9515



9515



9515



9516



9516



9516



9516



9516



9516



9516



9516



9516



9516





# WIN!

Go to [www.LEGOsurvey.com/product](http://www.LEGOsurvey.com/product) to fill out a survey for a chance to win a cool LEGO® Product. No purchase necessary. Open to all residents where not prohibited.



## [www.LEGOsurvey.com/product](http://www.LEGOsurvey.com/product)

### GEWINNE!

Nimm an der Umfrage auf [www.LEGOsurvey.com/product](http://www.LEGOsurvey.com/product) teil und hab die Chance ein cooles LEGO® Produkt zu gewinnen! Die Teilnahme am Gewinnspiel führt zu keinerlei Kaufverpflichtungen. Teilnahme in allen nicht ausgeschlossenen Ländern möglich.

### WIN!

Ga naar [www.LEGOsurvey.com/product](http://www.LEGOsurvey.com/product), vul een enquêteformulier in en maak kans op een cool LEGO® product. Geen aankoopverplichting. Iedereen mag deelnemen, uitgezonderd ingezetenden van landen waar een enquêteverbod geldt.

### GAGNE!

Visite [www.LEGOsurvey.com/product](http://www.LEGOsurvey.com/product) pour répondre à un questionnaire et avoir une chance de gagner un produit LEGO® très cool! Aucune obligation d'achat. Ouvert à tous les résidents des pays autorisés.

### 当てよう!

[www.LEGOsurvey.com/product](http://www.LEGOsurvey.com/product) にアクセスして、アンケートにご記入ください。当選者にはレゴ製品を差し上げます。お買い上げの必要はありません。禁止されていない限り、すべての皆様にご利用いただけます。